

THE
FEDERAL REPORTER.

VOLUME 164.

CASES ARGUED AND DETERMINED
IN THE
CIRCUIT COURTS OF APPEALS AND CIRCUIT
AND DISTRICT COURTS OF THE
UNITED STATES.

PERMANENT EDITION.

NOVEMBER, 1908—JANUARY, 1909.

WITH TABLE OF CASES IN WHICH REHEARINGS HAVE BEEN
GRANTED OR DENIED.

A TABLE OF STATUTES CONSTRUED IS GIVEN
IN THE INDEX.

ST. PAUL:
WEST PUBLISHING CO.
1909.

**COPYRIGHT, 1908,
BY
WEST PUBLISHING COMPANY.**

**COPYRIGHT, 1909,
BY
WEST PUBLISHING COMPANY.**

(164 FED.)

FEDERAL REPORTER, VOLUME 164.

JUDGES

OF THE

UNITED STATES CIRCUIT COURTS OF APPEALS AND THE
CIRCUIT AND DISTRICT COURTS.

FIRST CIRCUIT.

Hon. OLIVER WENDELL HOLMES, Circuit Justice.....Washington, D. C.
Hon. LE BARON B. COLT, Circuit Judge.....Providence, R. I.
Hon. WILLIAM L. PUTNAM, Circuit Judge.....Portland, Me.
Hon. FRANCIS C. LOWELL, Circuit Judge.....Boston, Mass.
Hon. CLARENCE HALE, District Judge, Maine.....Portland, Me.
Hon. FREDERIC DODGE, District Judge, Massachusetts.....Boston, Mass.
Hon. EDGAR ALDRICH, District Judge, New Hampshire.....Littleton, N. H.
Hon. ARTHUR L. BROWN, District Judge, Rhode Island.....Providence, R. I.

SECOND CIRCUIT.

Hon. RUFUS W. PECKHAM, Circuit Justice.....Washington, D. C.
Hon. E. HENRY LACOMBE, Circuit Judge.....New York, N. Y.
Hon. ALFRED C. COXE, Circuit Judge.....Utica, N. Y.
Hon. HENRY G. WARD, Circuit Judge.....New York, N. Y.
Hon. WALTER C. NOYES, Circuit Judge.....New London, Conn.
Hon. JAMES P. PLATT, District Judge, Connecticut.....Hartford, Conn.
Hon. THOMAS I. CHATFIELD, District Judge, E. D. New York.....Brooklyn, N. Y.
Hon. GEORGE W. RAY, District Judge, N. D. New York.....Norwich, N. Y.
Hon. GEORGE B. ADAMS, District Judge, S. D. New York.....New York, N. Y.
Hon. GEORGE C. HOLT, District Judge, S. D. New York.....New York, N. Y.
Hon. CHARLES M. HOUGH, District Judge, S. D. New York.....New York, N. Y.
Hon. JOHN R. HAZEL, District Judge, W. D. New York.....Buffalo, N. Y.
Hon. JAMES L. MARTIN, District Judge, Vermont.....Brattleboro, Vt.

THIRD CIRCUIT.

Hon. WILLIAM H. MOODY, Circuit Justice.....Washington, D. C.
Hon. GEORGE M. DALLAS, Circuit Judge.....Philadelphia, Pa.
Hon. GEORGE GRAY, Circuit Judge.....Wilmington, Del.
Hon. JOSEPH BUFFINGTON, Circuit Judge.....Pittsburgh, Pa.
Hon. EDWARD G. BRADFORD, District Judge, Delaware.....Wilmington, Del.
Hon. WILLIAM M. LANNING, District Judge, New Jersey.....Trenton, N. J.
Hon. JOSEPH CROSS, District Judge, New Jersey.....Elizabeth, N. J.
Hon. JOHN B. McPHERSON, District Judge, E. D. Pennsylvania.....Philadelphia, Pa.

Hon. JAMES B. HOLLAND, District Judge, E. D. Pennsylvania.....Philadelphia, Pa.
 Hon. ROBERT WODROW ARCHBALD, District Judge, M. D. Pennsylvania..Scranton, Pa.
 Hon. JAMES S. YOUNG, District Judge, W. D. PennsylvaniaPittsburgh, Pa.

FOURTH CIRCUIT.

Hon. MELVILLE W. FULLER, Circuit Justice.....Washington, D. C.
 Hon. NATHAN GOFF, Circuit Judge.....Clarksburg, W. Va.
 Hon. JETER C. PRITCHARD, Circuit Judge.....Asheville, N. C.
 Hon. THOMAS J. MORRIS, District Judge, Maryland.....Baltimore, Md.
 Hon. THOMAS R. PURNELL, District Judge, E. D. North Carolina¹.....Raleigh, N. C.
 Hon. JAMES E. BOYD, District Judge, W. D. North Carolina.....Greensboro, N. C.
 Hon. WILLIAM H. BRAWLEY, District Judge, E. and W. D. South Car.Charleston, S. C.
 Hon. EDMUND WADDILL, Jr., District Judge, E. D. Virginia.....Richmond, Va.
 Hon. HENRY CLAY McDOWELL, District Judge, W. D. Virginia.....Lynchburg, Va.
 Hon. ALSTON G. DAYTON, District Judge, N. D. West Virginia.....Philippi, W. Va.
 Hon. BENJAMIN F. KELLER, District Judge, S. D. West Virginia.....Bramwell, W. Va.

FIFTH CIRCUIT.

Hon. EDWARD D. WHITE, Circuit Justice.....Washington, D. C.
 Hon. DON A. PARDEE, Circuit Judge.....Atlanta, Ga.
 Hon. A. P. McCORMICK, Circuit Judge.....Dallas, Tex.
 Hon. DAVID D. SHELBY, Circuit Judge.....New Orleans, La.
 Hon. THOMAS G. JONES, District Judge, N. and M. D. Alabama...Montgomery, Ala.
 Hon. OSCAR R. HUNDLEY, District Judge, N. D. Alabama.....Birmingham, Ala.
 Hon. HARRY T. TOULMIN, District Judge, S. D. Alabama.....Mobile, Ala.
 Hon. WM. B. SHEPPARD, District Judge, N. D. FloridaPensacola, Fla.
 Hon. JAMES W. LOCKE, District Judge, S. D. FloridaJacksonville, Fla.
 Hon. WILLIAM T. NEWMAN, District Judge, N. D. Georgia.....Atlanta, Ga.
 Hon. EMORY SPEER, District Judge, S. D. Georgia.....Macon, Ga.
 Hon. EUGENE D. SAUNDERS, District Judge, E. D. Louisiana.....New Orleans, La.
 Hon. ALECK BOARMAN, District Judge, W. D. Louisiana.....Shreveport, La.
 Hon. HENRY C. NILES, District Judge, N. and S. D. Mississippi.....Kosciusko, Miss.
 Hon. DAVID E. BRYANT, District Judge, E. D. Texas.....Sherman, Tex.
 Hon. EDWARD R. MEEK, District Judge, N. D. Texas.....Dallas, Tex.
 Hon. WALLER T. BURNS, District Judge, S. D. Texas.....Houston, Tex.
 Hon. THOMAS S. MAXEY, District Judge, W. D. Texas.....Austin, Tex.

SIXTH CIRCUIT.

Hon. JOHN M. HARLAN, Circuit Justice.....Washington, D. C.
 Hon. HORACE H. LURTON, Circuit Judge.....Nashville, Tenn.
 Hon. HENRY F. SEVERENS, Circuit Judge.....Kalamazoo, Mich.
 Hon. JOHN K. RICHARDS, Circuit Judge.....Cincinnati, Ohio.
 Hon. ANDREW M. J. COCHRAN, District Judge, E. D. Kentucky.....Maysville, Ky.
 Hon. WALTER EVANS, District Judge, W. D. Kentucky.....Louisville, Ky.
 Hon. HENRY H. SWAN, District Judge, E. D. Michigan.....Detroit, Mich.
 Hon. LOYAL E. KNAPPEN, District Judge, W. D. Michigan.....Grand Rapids, Mich.
 Hon. ROBERT W. TAYLER, District Judge, N. D. Ohio.....Cleveland, Ohio.
 Hon. ALBERT C. THOMPSON, District Judge, S. D. Ohio.....Cincinnati, Ohio.
 Hon. JOHN E. SATER, District Judge, S. D. Ohio.....Columbus, Ohio.
 Hon. EDWARD T. SANFORD, District Judge, E. and M. D. Tennessee ..Knoxville, Tenn.
 Hon. JOHN E. McCALL, District Judge, W. D. Tennessee.....Memphis, Tenn.

¹ Died December 19, 1908.

SEVENTH CIRCUIT.

Hon. WILLIAM R. DAY, Circuit Justice.....Washington, D. C.
 Hon. PETER S. GROSSCUP, Circuit Judge.....Chicago, Ill.
 Hon. FRANCIS E. BAKER, Circuit Judge.....Indianapolis, Ind.
 Hon. WILLIAM H. SEAMAN, Circuit Judge.....Sheboygan, Wis.
 Hon. CHRISTIAN C. KOHLSAAT, Circuit Judge.....Chicago, Ill.
 Hon. KENESAW M. LANDIS, District Judge, N. D. Illinois.....Chicago, Ill.
 Hon. SOLOMON H. BETHEA, District Judge, N. D. Illinois.....Chicago, Ill.
 Hon. FRANCIS M. WRIGHT, District Judge, E. D. Illinois.....Urbana, Ill.
 Hon. J. OTIS HUMPHREY, District Judge, S. D. Illinois.....Springfield, Ill.
 Hon. ALBERT B. ANDERSON, District Judge, Indiana.....Indianapolis, Ind.
 Hon. JOSEPH V. QUARLES, District Judge, E. D. Wisconsin.....Milwaukee, Wis.
 Hon. ARTHUR L. SANBORN, District Judge, W. D. Wisconsin.....Madison, Wis.

EIGHTH CIRCUIT.

Hon. DAVID J. BREWER, Circuit Justice.....Washington, D. O.
 Hon. WALTER H. SANBORN, Circuit Judge.....St. Paul, Minn.
 Hon. WILLIS VAN DEVANter, Circuit Judge.....Cheyenne, Wyo.
 Hon. WILLIAM C. HOOK, Circuit Judge.....Leavenworth, Kan.
 Hon. ELMER B. ADAMS, Circuit Judge.....St. Louis, Mo.
 Hon. JACOB TRIEBER, District Judge, E. D. Arkansas.....Little Rock, Ark.
 Hon. JOHN H. ROGERS, District Judge, W. D. Arkansas.....Ft. Smith, Ark.
 Hon. ROBERT E. LEWIS, District Judge, Colorado.....Denver, Colo.
 Hon. HENRY THOMAS REED, District Judge, N. D. Iowa.....Cresco, Iowa.
 Hon. SMITH McPHERSON, District Judge, S. D. Iowa.....Red Oak, Iowa
 Hon. JOHN C. POLLOCK, District Judge, Kansas.....Topeka, Kan.
 Hon. MILTON D. PURDY, District Judge, Minnesota.....Minneapolis, Minn.
 Hon. PAGE MORRIS, District Judge, Minnesota.....Duluth, Minn.
 Hon. DAVID P. DYER, District Judge, E. D. Missouri.....St. Louis, Mo.
 Hon. JOHN F. PHILIPS, District Judge, W. D. Missouri.....Kansas City, Mo.
 Hon. W. H. MUNGER, District Judge, Nebraska.....Omaha, Neb.
 Hon. THOMAS C. MUNGER, District Judge, Nebraska.....Lincoln, Neb.
 Hon. CHARLES F. AMIDON, District Judge, North Dakota..... Fargo, N. D.
 Hon. RALPH E. CAMPBELL, District Judge, E. Oklahoma..... Muskogee, Okl.
 Hon. JOHN H. COTTERAL, District Judge, W. Oklahoma..... Guthrie, Okl.
 Hon. JOHN E. CARLAND, District Judge, South Dakota..... Sioux Falls, S. D.
 Hon. JOHN A. MARSHALL, District Judge, Utah..... Salt Lake City, Utah.
 Hon. JOHN A. RINER, District Judge, Wyoming..... Cheyenne, Wyo.

NINTH CIRCUIT.

Hon. JOSEPH McKENNA, Circuit Justice.....Washington, D. C.
 Hon. WILLIAM B. GILBERT, Circuit Judge.....Portland, Or.
 Hon. WM. W. MORROW, Circuit Judge.....San Francisco, Cal.
 Hon. ERSKINE M. ROSS, Circuit Judge.....Los Angeles, Cal.
 Hon. WM. C. VAN FLEET, District Judge, N. D. California.....San Francisco, Cal.
 Hon. JOHN J. DE HAVEN, District Judge, N. D. California.....San Francisco, Cal.
 Hon. OLIN WELLBORN, District Judge, S. D. California.....Los Angeles, Cal.
 Hon. FRANK S. DIETRICH, District Judge, Idaho.....Boise, Idaho.
 Hon. WILLIAM H. HUNT, District Judge, Montana.....Helena, Mont.
 Hon. EDWARD S. FARRINGTON, District Judge, Nevada.....Carson City, Nev.
 Hon. CHARLES E. WOLVERTON, District Judge, Oregon.....Portland, Or.
 Hon. EDWARD WHITSON, District Judge, E. D. Washington...Spokane, Wash.
 Hon. CORNELIUS H. HANFORD, District Judge, W. D. Washington.....Seattle, Wash.

CASES REPORTED.

	Page		Page
A. C. Bosselman & Co., Richardson v. (C. C.)	781	Brewster v. Goff Lumber Co. (D. C.)	124
Adams Exp. Co., Taylor v. (C. C. A.)	616	Brinkley, Indiana & Arkansas Lumber & Mfg. Co. v. (C. C. A.)	963
Adams & Hoyt Co., In re (D. C.)	489	Brooks & Son Co., Morrell v. (C. C.)	501
A. H. Ringk & Co. v. United States (C. C.)	1021	Brown, In re (C. C. A.)	673
Ajax Forge Co. v. Morden Frog & Crossing Works (C. C. A.)	843	Brown v. Major (C. C. A.)	673
Alaska Perseverance Min. Co., Thorndyke v. (C. C. A.)	657	Browning v. Funke (C. C.)	197
American Tobacco Co., United States v. (C. C.)	700	Bunker Hill & Sullivan Mining & Concentrating Co., McCarthy v. (C. C. A.)	927
Appliance Mfg. Co., Turner Brass Works v. (C. C.)	195	Butte Electric R. Co. v. Jones (C. C. A.)	308
Apsey, Kimball v. (C. C. A.)	830	Caldwell, In re (D. C.)	515
Atchison, T. & S. F. R. Co., Hamble v. (C. C. A.)	410	Californian Canneries Co. v. Pacific Sheet Metal Works (C. C. A.)	978
Atchison, T. & S. F. R. Co., Kaneko v. (C. C.)	263	Californian Canneries Co., Pacific Sheet Metal Works v. (C. C. A.)	980
Atlantis Fountain Pen Co., Cushman v. (C. C.)	94	Campfield v. Sauer (C. C. A.)	833
Avery Portable Lighting Co., Prest-O-Lite Co. v. (C. C.)	60	Cartel, Seigel v. (C. C. A.)	691
A. Waller & Co., Illinois Cent. R. Co. v. (C. C.)	358	Carter, Bell v. (C. C. A.)	417
A. Y. McDonaly & Morrison Mfg. Co., H. Mueller Mfg. Co. v. (C. C.)	991	Casterlin, United States v. (C. C.)	437
A. Y. McDonaly & Morrison Mfg. Co., H. Mueller Mfg. Co. v. (C. C.)	1001	Champion-International Co., Liberty v. (C. C.)	877
Ayres, Lofin v. (C. C. A.)	841	Chicago, R. I. & P. R. Co. v. Baldwin (C. C. A.)	826
Baglin v. Cusenier Co. (C. C. A.)	25	Chicago, R. I. & P. R. Co. v. Stepp (C. C. A.)	785
Baldwin, Chicago, R. I. & P. R. Co. v. (C. C. A.)	826	Chicago & N. W. R. Co., Barlow v. (C. C.)	765
Barlow v. Chicago & N. W. R. Co. (C. C.)	765	Citizens' Bank of Douglas, Ga. v. Hargraves (C. C. A.)	613
Barnes v. Pierce (C. C.)	213	City and County of San Francisco, San Francisco Gas & Electric Co. v. (C. C.)	884
Bartnett, In re (C. C. A.)	679	City of Memphis v. Postal Telegraph & Cable Co. (C. C. A.)	600
Bartnett v. Major (C. C. A.)	679	Clapp v. Leavens (C. C. A.)	318
Bedham, Gammino v. (C. C. A.)	593	Clarke, Harrison v. (C. C. A.)	539
Bell v. Carter (C. C. A.)	417	Clark, United States v. (D. C.)	75
Benjamin A. Van Brunt, The (D. C.)	775	Claussen & Co., In re (D. C.)	300
Birrell, St. Paul Fire & Marine Ins. Co. v. (D. C.)	104	Clearwater Shortline R. Co., McDonald v. (C. C.)	1007
Blanchard Shingle Co., In re (C. C. A.)	311	Cobb, Denver City Tramway Co. v. (C. C. A.)	41
Blodget v. Columbia Live Stock Co. (C. C. A.)	305	Colorado Farm & Live Stock Co., T. C. Henry & Sons Co. v. (C. C. A.)	986
Boardman v. Hanna (C. C.)	527	Columbia Live Stock Co., Blodget v. (C. C. A.)	305
Bolen-Darnall Coal Co. v. Williams (C. C. A.)	665	Commissioners of Lincoln Park, Westminster Co. of America v. (C. C.)	989
Bolognesi, United States v. (C. C.)	159	Cook Co. v. Little River Mfg. Co. (C. C.)	1005
Bosselman & Co., Richardson v. (C. C.)	781	Cook v. Klonos (C. C. A.)	529
Boston Woven Hose & Rubber Co. v. Pennsylvania Rubber Co. (C. C. A.)	557	Cook, Smith v. (D. C.)	628
Bowling Green Trust Co. v. Virginia Passenger & Power Co. (C. C.)	753	Corcoran v. Kostrometinoff (C. C. A.)	685
Bradley v. Heyward (C. C.)	107	Corser v. Sweet (C. C. A.)	1022
Bressler v. Ross (C. C. A.)	604	Craven, Mathieson v. (C. C.)	471
Brewster v. Goff (D. C.)	127	Curtis v. Humphrey (C. C. A.)	847
		Cusenier Co., Baglin v. (C. C. A.)	25
		Cushman v. Atlantis Fountain Pen Co. (C. C.)	94

	Page		Page
Davies, Wailes v. (C. C. A.)	397	Golden Malt Cream Co., National Chemical Co. v. (C. C. A.)	326
Davis v. Davis (C. C.)	281	Goldich, In re (D. C.)	882
Davis & Roesch Temperature Controlling Co. v. National Steam Specialty Co. (C. C.)	191	Gooding, Hobbs Mfg. Co. v. (C. C.)	91
Decker v. Pacific Coast S. S. Co. (C. C. A.)	974	Goodman v. Ft. Collins (C. C. A.)	970
Delaware & H. Co., Flannelly v. (C. C.)	303	Goodyear Tire & Rubber Co. v. Rubber Tire Wheel Co. (C. C.)	869
Delaware & H. Co., United States v. (C. C.)	215	Graham, Gaudette v. (C. C. A.)	311
Dement, Fairchild v. (C. C.)	200	Graham, United States v. (C. C.)	654
Deunzio Fruit Co. v. United States (C. C.)	909	Graser-Rothe, United States v. (C. C.)	205
Denver City Tramway Co. v. Cobb (C. C. A.)	41	Greek Mfg. Co., In re (D. C.)	211
Denver City Tramway Co., Robinson v. (C. C. A.)	174	Greenwood & Co., Watson, Preston & Co. v. (C. C.)	294
Deutsch v. Snowden (C. C. A.)	963	Greer v. Simmons (D. C.)	300
Dittgen v. Racine Paper Goods Co. (C. C.)	84	Grodson, United States v. (D. C.)	157
Dittgen v. Racine Paper Goods Co. (C. C.)	85	Grom v. Wittmann (C. C.)	523
Dr. Miles Medical Co. v. John D. Park & Sons Co. (C. C. A.)	803	Guarantee Gold Bond Loan & Savings Co. v. Edwards (C. C. A.)	809
Duke, Portland Gold Min. Co. v. (C. C. A.)	180	Haase, In re, two cases (C. C. A.)	1022
Eastern Dynamite Co. v. Keystone Powder Mfg. Co. (C. C.)	47	Haight & Freese Co., In re (C. C. A.)	688
E. C. Hazard & Co. v. United States (C. C.)	907	Hamble v. Atchison, T. & S. F. R. Co. (C. C. A.)	410
Edwards, Guarantee Gold Bond Loan & Savings Co. v. (C. C. A.)	809	Hanna, Boardman v. (C. C.)	527
82 Half-Boxes of Cheese, United States v. (D. C.)	778	Hardesty v. United States (C. C. A.)	420
Eldredge v. Horgan (C. C. A.)	415	Hargraves, Citizens' Bank of Douglas, Ga., v. (C. C. A.)	613
Enterprise Transp. Co., Whelan v. (C. C.)	95	Harris, In re (D. C.)	292
Essex County Park Commission, Stratton v. (C. C.)	901	Harrison v. Clarke (C. C. A.)	539
Evening Standard Pub. Co., In re (D. C.)	517	Harrison Supply Co. v. United States (C. C.)	155
Expanded Metal Co. v. General Fireproofing Co. (C. C. A.)	849	Hartford Fire Ins. Co., Wilson v. (C. C. A.)	817
Fairchild v. Dement (C. C.)	200	Haskell, In re (D. C.)	301
F. B. Vandegrift & Co. v. United States (C. C.)	65	Hazard & Co. v. United States (C. C.)	907
Fels, International Mercantile Marine Co. v. (D. C.)	337	H. C. Cook Co. v. Little River Mfg. Co. (C. C.)	1005
Fish Bros. Wagon Co., In re (C. C. A.)	553	Hecox, In re (C. C. A.)	823
Flannelly v. Delaware & H. Co. (C. C.)	303	Hecox v. Rollestone (C. C. A.)	823
Ft. Collins, Goodman v. (C. C. A.)	970	Hein v. Westinghouse Air Brake Co. (C. C.)	79
Friedman, In re (D. C.)	131	Henry & Sons & Co. v. Colorado Farm & Live Stock Co. (C. C. A.)	986
Fulton Bag & Cotton Mills v. Hudson Navigation Co. (C. C. A.)	1022	Heyward, Bradley v. (C. C.)	107
Funke, Browning v. (C. C.)	197	Hills v. Valentine (C. C. A.)	328
Galluccio, Prescott v. (D. C.)	618	Hite & Rafetto v. Savannah Electric Co. (C. C. A.)	944
Gammino v. Dedham (C. C. A.)	593	H. Mueller Mfg. Co. v. A. Y. McDonaly & Morrison Mfg. Co. (C. C.)	991
Gaudette v. Graham (C. C. A.)	311	H. Mueller Mfg. Co. v. A. Y. McDonaly & Morrison Mfg. Co. (C. C.)	1001
Gaynor, Royal Sales Co. v. (C. C.)	207	Hobbs Mfg. Co. v. Gooding (C. C.)	91
General Electric Co. v. Traction Equipment Co. (C. C.)	425	Hong Yon v. United States (C. C. A.)	330
General Fireproofing Co., Expanded Metal Co. v. (C. C. A.)	849	Horgan, In re (C. C. A.)	415
Geo. Brooks & Son Co., Morrell v. (C. C.)	501	Horgan, Eldredge v. (C. C. A.)	415
George, United States v. (C. C. A.)	45	Hudson Navigation Co., Fulton Bag & Cotton Mills v. (C. C. A.)	1022
German-American Filter Co. of New York, Loew Filter Co. v. (C. C. A.)	855	Humphrey, Curtis v. (C. C. A.)	847
Gitkin, In re (D. C.)	71	Illinois Cent. R. Co. v. A. Waller & Co. (C. C.)	358
Glickman & Pisonoff, In re (D. C.)	209	Illinois Cent. R. Co., Memphis Cotton Oil Co. v. (C. C.)	290
Goff, Brewster v. (D. C.)	127	Indiana & Arkansas Lumber & Mfg. Co. v. Brinkley (C. C. A.)	963
Goff Lumber Co., Brewster v. (D. C.)	124	Industrial Press v. W. R. C. Smith Pub. Co. (C. C. A.)	842
Golden Malt Cream Co., In re (C. C. A.)	326	International Mercantile Marine Co. v. Fels (D. C.)	337
		Interstate Commerce Commission, Missouri, K. & T. R. Co. v. (C. C.)	645

	Page		Page
Interstate Commerce Commission, Stickney v. (C. C.).....	638	McDonald v. Clearwater Shortline R. Co. (C. C.).....	1007
Interstate R. Co. v. Philadelphia, B. & T. St. R. Co. (C. C.).....	770	McDonald, Luckenbach v. (C. C.).....	296
Jackson Lumber Co. v. McCrimmon (C. C.).....	759	McDonaly & Morrison Mfg. Co., H. Mueller Mfg. Co. v. (C. C.).....	991
Jackson, Vary v. (C. C. A.).....	840	McDonaly & Morrison Mfg. Co., H. Mueller Mfg. Co. v. (C. C.).....	1001
J. C. H. Claussen & Co., In re (D. C.).....	300	McEwen v. Totten (C. C. A.).....	837
Jenks, Leona Garment Co. v. (C. C. A.).....	188	McGilvra v. Ross (C. C. A.).....	604
Jerome H. Remick & Co., Stern v. (C. C.).....	781	McNamee, Kelley v. (C. C. A.).....	369
Jin Dun v. United States (C. C. A.).....	330	McVickar, United States v. (C. C.).....	894
John D. Park & Sons Co., Dr. Miles Medical Co. v. (C. C. A.).....	803	Major, Bartnett v. (C. C. A.).....	679
Johnston, Ligon v. (C. C. A.).....	670	Major, Brown v. (C. C. A.).....	673
Joline v. Metropolitan Securities Co. (C. C.).....	144	Marrin, Ex parte (D. C.).....	631
Joline v. Metropolitan Securities Co. (C. C.).....	650	Marshall v. Pettingell-Andrews Co. (C. C. A.).....	862
Jones, Butte Electric R. Co. v. (C. C. A.).....	308	Martin, Nazima Trading Co. v. (C. C. A.).....	838
Joseph P. Tucker, The (D. C.).....	746	Mathieson v. Craven (C. C.).....	471
Kaneko v. Atchison, T. & S. F. R. Co. (C. C.).....	263	Max Mayer & Co., United States v. (C. C.).....	905
Kansas City v. Metropolitan Water Co. (C. C.).....	728	Mayer & Co., United States v. (C. C.).....	905
Kansas City, Metropolitan Water Co. v. (C. C.).....	738	Meakins, In re (D. C.).....	334
Kelley v. McNamee (C. C. A.).....	369	Memphis Cotton Oil Co. v. Illinois Cent. R. Co. (C. C.).....	290
Keystone Powder Mfg. Co., Eastern Dynamite Co. v. (C. C.).....	47	Mescall, United States v., four cases (C. C.).....	580
Kibbee, The William B. (D. C.).....	653	Mescall, United States v., three cases (C. C.).....	584
Kimball v. Apsey (C. C. A.).....	830	Mescall, United States v., three cases (C. C.).....	587
Klonos, Cook v. (C. C. A.).....	529	Metropolitan Securities Co., Joline v. (C. C.).....	144
Kostrometinoff, Corcoran v. (C. C. A.).....	685	Metropolitan Securities Co., Joline v. (C. C.).....	650
Kunzig, Luckenbach v. (C. C.).....	296	Metropolitan Water Co. v. Kansas City (C. C.).....	738
Kyte, In re (D. C.).....	302	Metropolitan Water Co., Kansas City v. (C. C.).....	728
Lacey v. Thomas (C. C.).....	623	Mexican Cent. R. Co., Pyman S. S. Co. v. (D. C.).....	441
Larson, Woldson v. (C. C. A.).....	548	Miles Medical Co. v. John D. Park & Sons Co. (C. C. A.).....	803
Leavens, Clapp v. (C. C. A.).....	318	Miller, United States v. (C. C.).....	444
Lee Sher Wing, In re (D. C.).....	506	Mills v. Virginia-Carolina Lumber Co. (C. C. A.).....	168
Lemon v. United States (C. C. A.).....	953	Missouri, K. & T. R. Co. v. Interstate Commerce Commission (C. C.).....	645
Leona Garment Co. v. Jenks (C. C. A.).....	188	Montana Cent. R. Co. v. United States (C. C. A.).....	400
Lew Moy v. United States (C. C. A.).....	322	Moody, United States v. (D. C.).....	269
Liberty v. Champion-International Co. (C. C.).....	877	Morden Frog & Crossing Works, Ajax Forge Co. v. (C. C. A.).....	843
Ligon v. Johnston (C. C. A.).....	670	Morrell v. Geo. Brooks & Son Co. (C. C.).....	501
Link Belt Machinery Co., Morse Chain Co. v. (C. C. A.).....	331	Morse Chain Co. v. Link Belt Machinery Co. (C. C. A.).....	331
Little River Mfg. Co., H. C. Cook Co. v. (C. C.).....	1005	Morse v. United States (C. C. A.).....	1023
Llewellyn, Morton v. (C. C. A.).....	693	Morton v. Llewellyn (C. C. A.).....	693
Lockwood, United States v. (D. C.).....	772	Mueller Mfg. Co. v. A. Y. McDonaly & Morrison Mfg. Co. (C. C.).....	991
Loew Filter Co. v. German-American Filter Co. of New York (C. C. A.).....	855	Mueller Mfg. Co. v. A. Y. McDonaly & Morrison Mfg. Co. (C. C.).....	1001
Lofin v. Ayres (C. C. A.).....	841	Murray v. Wilson Distilling Co. (C. C. A.).....	1
Lothrop v. United States (C. C.).....	99	Naday & Fleischer v. United States (C. C. A.).....	44
Louisville & N. R. Co. v. Phillips (C. C. A.).....	1022	National Chemical Co. v. Golden Malt Cream Co. (C. C. A.).....	326
Love, Poland v. (C. C. A.).....	186	National Steam Specialty Co., Davis & Roesch Temperature Controlling Co. v. (C. C.).....	191
Luckenbach v. Kunzig (C. C.).....	296		
Luckenbach v. McDonald (C. C.).....	296		
Lynch v. Union Trust Co. of San Francisco (C. C. A.).....	161		
McCarthy v. Bunker Hill & Sullivan Mining & Concentrating Co. (C. C. A.).....	927		
McCrimmon, Jackson Lumber Co. v. (C. C.).....	759		

	Page		Page
Nazima Trading Co. v. Martin (C. C. A.)..	838	Ringk & Co. v. United States (C. C.).....	1021
New Standard Concentrator Co., Wilfley v. (C. C. A.).....	421	Rionda, In re (D. C.).....	368
New York Cent. & H. R. R. Co., United States v. (C. C. A.).....	324	Robinson v. Denver City Tramway Co. (C. C. A.).....	174
Niagara Radiator Co., In re (D. C.).....	102	Robinson, United States v. (C. C.).....	444
Noojin v. United States (C. C. A.).....	692	Rogers, United States v. (D. C.).....	520
Noojin v. United States (C. C. A.).....	1023	Rollestone, Hecox v. (C. C. A.).....	823
Northern Pac. R. Co., Trodick v. (C. C. A.)	913	Ronchi, Ex parte (D. C.).....	288
Northern Pac. R. Co., Winfree v. (C. C.)..	698	Ross, Bressler v. (C. C. A.).....	604
One Hundred Tons of Kainit, Pyman S. S. Co. v. (D. C.).....	364	Ross, McGilvra v. (C. C. A.).....	604
Pacific Coast S. S. Co., Decker v. (C. C. A.).....	974	Royal Sales Co. v. Gaynor (C. C.).....	207
Pacific Sheet Metal Works v. Californian Canneries Co. (C. C. A.).....	980	Rubber Tire Wheel Co., Goodyear Tire & Rubber Co. v. (C. C.).....	869
Pacific Sheet Metal Works, Californian Canneries Co. v. (C. C. A.).....	978	Ruos, In re (D. C.).....	749
Park & Sons Co., Dr. Miles Medical Co. v. (C. C. A.).....	803	St. Paul Fire & Marine Ins. Co. v. Birrell (D. C.).....	104
Park & Tilford v. United States (C. C.)..	910	San Francisco Gas & Electric Co. v. City and County of San Francisco (C. C.)....	884
Parsons Non-Skid Co. v. Victor Tire Grip Co. (C. C.).....	617	Sauer, Campfield v. (C. C. A.).....	833
Passavant & Co., United States v. (C. C.)..	912	Savannah Electric Co., Hite & Rafetto v. (C. C. A.).....	944
Pearce v. Sutherland (C. C. A.).....	609	Schlippenbach, In re (D. C.).....	783
Pennsylvania Rubber Co., Boston Woven Hose & Rubber Co. v. (C. C. A.).....	557	Schneider, In re (C. C.).....	335
Pettingell-Andrews Co., Marshall v. (C. C. A.).....	862	Schulman & Goldstein, In re (D. C.).....	440
Pfaffinger, In re (D. C.).....	526	Scott & West, United States v. (C. C.)....	285
Philadelphia, B. & T. St. R. Co., Interstate R. Co. v. (C. C.).....	770	Seigel v. Cartel (C. C. A.).....	691
Phillips, Louisville & N. R. Co. v. (C. C. A.).....	1022	Siegel, In re (D. C.).....	559
Pierce, Barnes v. (C. C.).....	213	Simmons, Greer v. (D. C.).....	300
Pittsburg Drug Co., In re (D. C.).....	482	646 Half-Boxes of Figs, United States v. (D. C.).....	778
Poland v. Love (C. C. A.).....	186	Smith v. Cook (D. C.).....	628
Pomona, Sunset Telephone & Telegraph Co. v. (C. C.).....	561	Smith v. Pratt Consolidated Coal Co. (C. C. A.).....	1023
Portland Gold Min. Co. v. Duke (C. C. A.)..	180	Smith Pub. Co., Industrial Press v. (C. O. A.).....	842
Postal Telegraph & Cable Co., City of Memphis v. (C. C. A.).....	600	Snowden, Deutsch v. (C. C. A.).....	963
Pottsville, The (D. C.).....	447	Somers, United States v. (D. C.).....	259
Pratt Consolidated Coal Co., Smith v. (C. C. A.).....	1023	Southern R. Co., United States v. (D. C.)..	347
Prescott v. Galluccio (D. C.).....	618	Stamatopoulos, United States v., three cases (C. C.).....	524
Prest-O-Lite Co. v. Avery Portable Lighting Co. (C. C.).....	60	Standard Oil Co. of Indiana v. United States (C. C. A.).....	376
Printer, The (C. C. A.).....	314	Stepp, Chicago, R. I. & P. R. Co. v. (C. C. A.).....	785
Pyman S. S. Co. v. Mexican Cent. R. Co. (D. C.).....	441	Sterlingworth Ry. Supply Co., In re (D. C.)	591
Pyman S. S. Co. v. One Hundred Tons of Kainit (D. C.).....	304	Stern v. Jerome H. Remick & Co. (C. C.)..	781
Racine Paper Goods Co., Dittgen v. (C. C.)	84	Stickney v. Interstate Commerce Commission (C. C.).....	638
Racine Paper Goods Co., Dittgen v. (C. C.)	85	Stratton v. Essex County Park Commission (C. C.).....	901
Ranza, The (D. C.).....	699	Sunset Telephone & Telegraph Co. v. Pomona (C. C.).....	561
Reagan, In re (C. C. A.).....	415	Sutherland, Pearce v. (C. C. A.).....	609
Remick & Co., Stern v. (C. C.).....	781	Sweet, Corser v. (C. C. A.).....	1022
Republic Iron & Steel Co. v. Tobin (C. C. A.).....	38	Syracuse Paper & Pulp Co., In re (D. C.)..	275
Rice, In re (D. C.).....	509	Taylor v. Adams Exp. Co. (C. C. A.).....	616
Rice, In re (D. C.).....	589	T. C. Henry & Sons & Co. v. Colorado Farm & Live Stock Co. (C. C. A.).....	986
Rice, In re, two cases (D. C.).....	514	Thomas, Lacey v. (C. C.).....	623
Richardson v. A. C. Bosselman & Co. (C. C.).....	781	Thomson-Houston Electric Co. v. Traction Equipment Co. (C. C.).....	425
Rickey Land & Cattle Co., United States v. (C. C.).....	496	Thorndyke v. Alaska Perseverance Min. Co. (C. C. A.).....	657
		Title Guarantee & Trust Co. v. Ward (C. C.).....	459
		Tobin, Republic Iron & Steel Co. v. (C. C. A.).....	38
		Totten, McEwen v. (C. C. A.).....	837

	Page		Page
Traction Equipment Co., General Electric Co. v. (C. C.).....	425	United States v. 646 Half-Boxes of Figs (D. C.).....	778
Traction Equipment Co., Thomson-Houston Electric Co. v. (C. C.).....	425	United States v. Somers (D. C.).....	259
Trodick v. Northern Pac. R. Co. (C. C. A.).....	913	United States v. Southern R. Co. (D. C.)..	347
Tucker, The Joseph P. (D. C.).....	746	United States v. Stamatopoulos, three cases (C. C.).....	524
Turner Brass Works v. Appliance Mfg. Co. (C. C.).....	195	United States, Standard Oil Co. of Indiana v. (C. C. A.).....	376
Ucayali, The (D. C.).....	897	United States v. Varnavelias (C. C.).....	524
Union Trust Co. of St. Louis, Westhus v. (C. C. A.).....	795	United States v. Watchorn (C. C.).....	152
Union Trust Co. of San Francisco, Lynch v. (C. C. A.).....	161	Valentine, Hills v. (C. C. A.).....	328
United States, A. H. Ringk & Co. v. (C. C.).....	1021	Van Brunt, The Benjamin A. (D. C.)....	775
United States v. American Tobacco Co. (C. C.).....	700	Van Buren, In re (D. C.).....	883
United States v. Bolognesi (C. C.).....	159	Vandegrift & Co. v. United States (C. C.)..	65
United States v. Casterlin (C. C.).....	437	Varnavelias, United States v. (C. C.).....	524
United States v. Clark (D. C.).....	75	Vary v. Jackson (C. C. A.).....	840
United States v. Delaware & H. Co. (C. C.).....	215	Victor Tire Grip Co., Parsons Non-Skid Co. v. (C. C.).....	617
United States, Denunzio Fruit Co. v. (C. C.).....	909	Virginia-Carolina Chemical Co., West Hartlepool Steam Navigation Co. v. (C. C. A.)	836
United States, E. C. Hazard & Co. v. (C. C.).....	907	Virginia-Carolina Lumber Co., Mills v. (C. C. A.).....	168
United States v. 82 Half-Boxes of Cheese (D. C.).....	778	Virginia Passenger & Power Co., Bowling Green Trust Co. v. (C. C.).....	753
United States, F. B. Vandegrift & Co. v. (C. C.).....	65	Wagoner Nat. Bank v. Welch (C. C. A.)..	813
United States v. George (C. C. A.).....	45	Walles v. Davies (C. C. A.).....	397
United States v. Graham (C. C.).....	654	Walker, In re (C. C. A.).....	680
United States v. Graser-Rothe (C. C.)....	205	Walker v. Woodside (C. C. A.).....	680
United States v. Grodson (D. C.).....	157	Waller & Co., Illinois Cent. R. Co. v. (C. C.).....	358
United States, Hardesty v. (C. C. A.).....	420	Ward, Title Guarantee & Trust Co. v. (C. C.).....	459
United States, Harrison Supply Co. v. (C. C.).....	155	Watchorn, United States v. (C. C.).....	152
United States, Hong Yon v. (C. C. A.).....	330	Watson, Preston & Co. v. Greenwood & Co. (C. C.).....	294
United States, Jin Dun v. (C. C. A.).....	330	Welch, Wagoner Nat. Bank v. (C. C. A.)..	813
United States, Lemon v. (C. C. A.).....	953	West Hartlepool Steam Navigation Co. v. Virginia-Carolina Chemical Co. (C. C. A.).....	836
United States, Lew Moy v. (C. C. A.).....	322	Westhus v. Union Trust Co. of St. Louis (C. C. A.).....	795
United States v. Lockwood (D. C.).....	772	Westinghouse Air Brake Co., Hein v. (C. C.).....	79
United States, Lothrop v. (C. C.).....	99	Westrumite Co. of America v. Commissioners of Lincoln Park (C. C.).....	989
United States v. McVickar (C. C.).....	894	Whelan v. Enterprise Transp. Co. (C. C.)..	95
United States v. Max Mayer & Co. (C. C.)	905	Wilfley v. New Standard Concentrator Co. (C. C. A.).....	421
United States v. Mescall, four cases (C. C.)	580	Willard, Williamsburgh City Fire Ins. Co. of Brooklyn v. (C. C. A.).....	404
United States v. Mescall, three cases (C. C.)	584	William B. Kibbee, The (D. C.).....	653
United States v. Mescall, three cases (C. C.)	587	Williams, Bolen-Darnall Coal Co. v. (C. C. A.).....	665
United States v. Miller (C. C.).....	444	Williamsburgh City Fire Ins. Co. of Brooklyn v. Willard (C. C. A.).....	401
United States, Montana Cent. R. Co. v. (C. C. A.).....	400	Wilson Distilling Co., Murray v. (C. C. A.)	1
United States v. Moody (D. C.).....	269	Wilson v Hartford Fire Ins. Co. (C. C. A.)	817
United States, Morse v. (C. C. A.).....	1023	Winfree v. Northern Pac. R. Co. (C. C.)..	698
United States, Naday & Fleischer v. (C. C. A.).....	44	Wittmann, Groom v. (C. C.).....	523
United States v. New York Cent. & H. R. R. Co. (C. C. A.).....	324	Woldson v. Larson (C. C. A.).....	548
United States, Noojin v. (C. C. A.).....	692	Wolf Co., In re (D. C.).....	448
United States, Noojin v. (C. C. A.).....	1023	Woodside, Walker v. (C. C.).....	680
United States, Park & Tilford v. (C. C.)..	910	W. R. C. Smith Pub. Co., Industrial Press v. (C. C. A.).....	842
United States v. Passavant & Co. (C. C.)	912		
United States v. Rickey Land & Cattle Co. (C. C.).....	496		
United States v. Robinson (C. C.).....	444		
United States v. Rogers (D. C.).....	520		
United States v. Scott & West (C. C.)....	285		

CASES CITED.

	Page		Page
Abbotsford, The, 98 U. S. 444, 25 L. Ed. 168	364	American Surety Co. v. Pauly, 170 U. S. 133, 18 Sup. Ct. 552, 42 L. Ed. 977	79
Abbott v. Duluth (C. C.) 104 Fed. 833, 836, 837	573, 578	American Tobacco Co. v. Werckmeister, 146 Fed. 375, 76 C. C. A. 647	781, 782
Acker v. Hautemann, 27 Hun (N. Y.) 48	783	American Trust Co. v. Wallis, 126 Fed. 466, 61 C. C. A. 344	752
Adam v. British, etc., S. S. Co., (1898) 2 Q. B. 430	263, 268	Amsinck v. Balderston, 41 Fed. 641	767
Adams v. New York, 192 U. S. 585, 24 Sup. Ct. 372, 48 L. Ed. 575	421	An Alien, In re, Fed. Cas. No. 201a	336
Addystone Pipe Co. v. U. S., 175 U. S. 211, 20 Sup. Ct. 96, 44 L. Ed. 136	242, 715, 727	Anderson v. May, 50 Minn. 280, 52 N. W. 530, 17 L. R. A. 555, 36 Am. St. Rep. 642	985
Adler v. Thorp, 102 Wis. 70, 78 N. W. 184	137	Anderson v. U. S., 171 U. S. 604, 19 Sup. Ct. 50, 43 L. Ed. 300	725
Adriance, Platt & Co. v. National Harrow Co., 121 Fed. 827, 53 C. C. A. 163	84, 87	Angier v. Eaton, Cole & Burnham Co., 98 Pa. 594, 42 Am. Rep. 624	424
Advent v. Farrow, 7 Rich. Eq. 378	116	Anson v. Railroad Co., 23 How. 1, 16 L. Ed. 517	687
Aerkfetz v. Humphreys, 145 U. S. 418, 12 Sup. Ct. 835, 36 L. Ed. 758	40	Apsey v. Whittimore, 85 N. E. 91	832
Ætna Indemnity Co. v. Coal Co., 83 C. C. A. 431, 154 Fed. 545	177	Arbuckle v. Kirkpatrick, 98 Tenn. 221, 39 S. W. 3, 36 L. R. A. 285, 60 Am. St. Rep. 854	805
Agawam Co. v. Jordan, 7 Wall. 583, 603, 19 L. Ed. 177	55	Archibald v. Thompson, 2 Colo. 388, 391	972
Alabama Mfg. Co. v. Robinson, 72 Fed. 708, 19 C. C. A. 152	758	Ard v. Brandon, 156 U. S. 537, 543, 15 Sup. Ct. 406, 39 L. Ed. 524	925
Alabama & G. S. R. Co. v. Coggins, 88 Fed. 455, 32 C. C. A. 1	793	Arkansas Valley Smelting Co. v. Belden Min. Co., 127 U. S. 379, 8 Sup. Ct. 1308, 32 L. Ed. 246	103
Alaska Commercial Co. v. Williams, 128 Fed. 362, 63 C. C. A. 92	317	Ark Foo v. U. S., 128 Fed. 697, 63 C. C. A. 249	330
Alaska Min. Co. v. Whelan, 158 U. S. 86, 18 Sup. Ct. 40, 42 L. Ed. 390	182	Armour Packing Co. v. U. S., 209 U. S. 56, 28 Sup. Ct. 428, 437, 52 L. Ed. 681	381
Alexander v. Gordon, 101 Fed. 91, 96, 97, 98, 41 C. C. A. 228	966, 969	Arthur v. Morgan, 112 U. S. 495, 5 Sup. Ct. 241, 28 L. Ed. 825	101
Alfson v. Bush Co., 182 N. Y. 393, 75 N. E. 230, 108 Am. St. Rep. 815	266	Asher v. Texas, 128 U. S. 129, 9 Sup. Ct. 1, 32 L. Ed. 368	714
Alger, Smith & Co. v. Duluth, etc., Co., 93 Minn. 314, 101 N. W. 298	43	Aspden v. Nixon, 4 How. 466, 467, 468, 497, 498, 11 L. Ed. 1059	821, 822
Algor, In re (D. C.) 15 Am. Bankr. Rep. 705, 117 Fed. 575	210	Aspinwall Mfg. Co. v. Gill (C. C.) 32 Fed. 697, 700	50
Allen v. Curtis, 26 Conn. 456	613	Atkinson v. Pack, 114 N. C. 597, 604, 19 S. E. 628	988
Allen v. Pullman Co., 191 U. S. 171, 24 Sup. Ct. 39, 48 L. Ed. 134	568	Atlantic Delaine Co. v. James, 94 U. S. 207, 24 L. Ed. 112	204
Allgeyer v. Louisiana, 165 U. S. 578, 589, 17 Sup. Ct. 427, 41 L. Ed. 832	240	Atlantic & P. Tel. Co. v. Philadelphia, 190 U. S. 160, 164, 23 Sup. Ct. 817, 47 L. Ed. 995	603
Alvord, In re (D. C.) 14 Am. Bankr. Rep. 264, 135 Fed. 236	301	Attorney General of Great Britain v. Great Northern R. Co., 29 Law Journal (N. S. Eq.) 794	254, 256
American Biscuit, etc., Co. v. Klotz (C. C.) 44 Fed. 724	721	Atwood v. Chicago, R. I. & P. R. Co. (C. C.) 72 Fed. 447	411, 790
American Brewing Co., In re, 112 Fed. 752, 50 C. C. A. 517	825	Augusta R. Co. v. Glover, 92 Ga. 132, 142, 143, 18 S. E. 406	263, 269
American Bridge Co. v. Seeds, 75 C. C. A. 407, 144 Fed. 605, 11 L. R. A. (N. S.) 1041	182	Austin v. Walton, 68 Tex. 507, 5 S. W. 70	176
American Caramel Co. v. Mills (C. C. A.) 162 Fed. 147	60		
American Eagle, The (D. C.) 54 Fed. 1010	317		

Page	Page
Automatic Weighing Mach. Co. v. Pneumatic Scale Co. (C. C.) 158 Fed. 415 192, 196	Beasley v. Coggins, 12 Am. Bankr. Rep. 355, 48 Fla. 215, 37 South. 213..... 623
Ayres v. Watson, 113 U. S. 594, 609, 5 Sup. Ct. 641, 28 L. Ed. 1093..... 668	Beavers, In re (C. C.) 131 Fed. 366..... 635
Badger v. Badger, Fed. Cas. No. 717, 1 Cliff. 237..... 903	Behn v. Campbell, 205 U. S. 407, 27 Sup. Ct. 504, 51 L. Ed. 857..... 983
Badische Anilin & Soda Fabrik v. Kalle & Co., 104 Fed. 802, 44 C. C. A. 201... 860	Belgenland, The, 114 U. S. 363, 364, 5 Sup. Ct. 860, 29 L. Ed. 152..... 899, 900
Baer, Appeal of (Pa.) 18 Atl. 1, 4 L. R. A. 609..... 687	Belk v. Meagher, 104 U. S. 279, 26 L. Ed. 735..... 536
Bailey v. Glover, 21 Wall. 342, 22 L. Ed. 636..... 841	Bellamy v. Debenham, 45 Ch. Div. L. R. 481, 1 Ch. Div. (1891) L. R. 412..... 952
Baiz, In re, 135 U. S. 403, 10 Sup. Ct. 854, 34 L. Ed. 222..... 185	Bennichsen v. Market St. R. Co., 149 Cal. 18, 84 Pac. 420..... 43
Baker v. Kelley, 11 Minn. 480 (Gil. 358)..... 969	Betts v. U. S., 132 Fed. 228, 65 C. C. A. 452..... 896
Baker & Hamilton v. Williamsburgh City Fire Ins. Co. (C. C.) 157 Fed. 280..... 408	Bick, Ex parte (C. C.) 155 Fed. 908..... 74
Baldwin v. Rice, 44 Miss. Rep. 64, 89 N. Y. Supp. 738..... 822	Bigelow v. Calumet, etc., Min. Co. (C. C.) 155 Fed. 869..... 718
Baldwin v. Short, 125 N. Y. 553, 559, 560, 26 N. E. 928..... 623	Billings v. Russell, 101 N. Y. 226, 4 N. E. 531..... 623
Ballard v. Hunter, 204 U. S. 241, 27 Sup. Ct. 261, 51 L. Ed. 461; 74 Ark. 174, 85 S. W. 252..... 965, 967	Billings v. Smelting Co., 2 C. C. A. 252, 262, 263, 51 Fed. 338, 349..... 969
Baltimore & O. R. Co. v. Baugh, 149 U. S. 368, 384, 13 Sup. Ct. 914, 37 L. Ed. 772..... 550	Bishop of Nesqually v. Gibbon, 158 U. S. 155, 15 Sup. Ct. 779, 39 L. Ed. 931... 919
Bank v. Massey, 192 U. S. 138, 24 Sup. Ct. 199, 48 L. Ed. 380..... 1013	Blackburn v. Portland Gold Min. Co., 175 U. S. 571, 20 Sup. Ct. 222, 44 L. Ed. 276..... 607
Bank v. Shedd, 121 U. S. 74, 7 Sup. Ct. 807, 30 L. Ed. 877..... 757	Blakeney v. Goode, 30 Ohio St. 350, 360... 63
Bank of Commerce v. Fowler, 93 Wis. 241, 245, 67 N. W. 423..... 143	Blieler v. Moore, 88 Wis. 438, 60 N. W. 792..... 140
Bank of United States v. Planters' Bank of Georgia, 9 Wheat. 904, 6 L. Ed. 244..... 17, 22	Blount v. Grand Trunk R. Co., 61 Fed. 375, 9 C. C. A. 526..... 829
Barbed Wire Patent, The, 143 U. S. 275, 283, 292, 12 Sup. Ct. 443, 36 L. Ed. 154..... 697, 1000	Blue Bird Min. Co. v. Largey (C. C.) 49 Fed. 289, 291..... 608
Barber v. Morris, 37 Minn. 194, 33 N. W. 559, 5 Am. St. Rep. 836..... 969	Blue Ridge Packing Co., In re (D. C.) 125 Fed. 619..... 280
Barbier v. Connolly, 113 U. S. 27, 5 Sup. Ct. 357, 28 L. Ed. 923..... 236	Boatmen's Fire Ins. Co. v. Parker, 23 Ohio St. 85, 13 Am. Rep. 228..... 408
Barcus v. Gates, 89 Fed. 783, 791, 32 C. C. A. 337..... 64	Bobbs Merrill Co. v. Straus, 210 U. S. 339, 28 Sup. Ct. 722, 52 L. Ed. 1086... 805
Barney v. Saunders, 16 How. 535, 14 L. Ed. 1047..... 687	Boesch v. Graf, 133 U. S. 697, 10 Sup. Ct. 378, 33 L. Ed. 787..... 872
Barrow S. S. Co. v. Kane, 170 U. S. 100-112, 18 Sup. Ct. 526, 42 L. Ed. 964..... 768, 769	Bogan v. Mortgage Co., 11 C. C. A. 128, 135, 63 Fed. 192, 199..... 969
Barry v. Edmunds, 116 U. S. 550, 6 Sup. Ct. 501, 29 L. Ed. 729..... 988	Boker & Co. v. U. S., G. A. 5, 879 (T. D. 25-892); 140 Fed. 115, T. D. 26, 451; 145 Fed. 1022, 74 C. C. A. 681, T. D. 27-192..... 99
Barry v. Missouri, etc. (C. C.) 27 Fed. 1..... 280	Bolles v. Outing Co., 175 U. S. 266, 20 Sup. Ct. 94, 44 L. Ed. 156..... 782
Barry v. Otto, 56 Mo. 177..... 320	Bond v. Howell, 11 Paige (N. Y.) 233, 972, 973..... 382
Bartlett v. Branchall, 3 Gray (Mass.) 257, 260..... 556	Bonker v. People, 37 Mich. 4..... 264
Bartlett v. Worcester Consol. St. R. Co., 189 Mass. 360, 75 N. E. 706..... 43	Bonthron v. Phoenix Light & Fuel Co., 8 Ariz. 129, 71 Pac. 941, 61 L. R. A. 563, 566..... 264
Bass v. U. S., 20 App. D. C. 232..... 895	Boom Co. v. Patterson, 98 U. S. 403, 25 L. Ed. 206..... 736, 743
Batchelder v. Moore, 42 Cal. 412..... 74	Borer v. Chapman, 119 U. S. 587, 590, 591, 598, 599, 7 Sup. Ct. 342, 30 L. Ed. 532..... 821, 822
Bates v. Coe, 98 U. S. 31, 25 L. Ed. 68... 194	Boruszewski v. Middlesex, 186 Mass. 589-593, 72 N. E. 250..... 600
Battler, The (D. C.) 55 Fed. 1006..... 317	Bound Brook, The (D. C.) 146 Fed. 160... 899
Bear Lake Irr. Co. v. Garland, 164 U. S. 1, 18, 19, 17 Sup. Ct. 7, 12, 41 L. Ed. 327..... 499	Bound v. South Carolina R. Co. (C. C.) 50 Fed. 853..... 757
	Bowden v. Burnham, 59 Fed. 752, 8 C. C. A. 248..... 972, 973
	Rowdoin College v. Merritt (C. C.) 59 Fed. 6..... 772

	Page		Page
Bowlby v. Shively, 22 Or. 410, 30 Pac. 154	608	Burgess v. Seligman, 107 U. S. 20, 33, 34, 2 Sup. Ct. 10, 27 L. Ed. 359	573
Bowling Green Trust Co. v. Virginia Passenger & Power Co. (C. C.) 132 Fed. 921, 925	756	Burkhardt v. Haycox, 19 Colo. 339, 35 Pac. 730	971
Bowman, Appeal of, 34 Pa. 19, 23	468	Burlington, C. R. & N. R. Co. v. Dunn, 122 U. S. 513-517, 7 Sup. Ct. 1262, 30 L. Ed. 1159	769
Boyd v. Glucklich, 8 Am. Bankr. Rep. 401, 116 Fed. 134, 136, 53 C. C. A. 451, 454	74	Burt v. Gotzian, 102 Fed. 937, 43 C. C. A. 59	143
Boyd v. U. S., 116 U. S. 616, 6 Sup. Ct. 524, 29 L. Ed. 746	293	Butler v. Haskell, 4 Desaus. 651	116
Boyles v. Boyles, 37 Iowa, 592	969	Butler v. Watkins, 13 Wall. 456, 467, 20 L. Ed. 629	139
Boyle v. Zacharie, 6 Pet. 635, 637, 8 L. Ed. 527	693	Butterwick, In re (D. C.) 12 Am. Bankr. Rep. 536, 131 Fed. 371	623
Bradford v. Expanded Metal Co., 146 Fed. 984, 77 C. C. A. 230	850	Butthield v. Stranahan, 192 U. S. 470, 24 Sup. Ct. 349, 43 L. Ed. 525	271
Bradford v. Southern Ry., 195 U. S. 243, 25 Sup. Ct. 55, 49 L. Ed. 178	617	Byers v. Surget, 19 How. 303, 15 L. Ed. 670	118
Branch Sons & Co. v. Knapp, 61 Ga. 615	493	Byrne v. Kansas City, Ft. S. & M. R. Co., 61 Fed. 605, 607, 9 C. C. A. 666, 24 L. R. A. 693	791
Brandlyn v. Ord, 1 Atk. 571	903	Byrnes v. Vols, 53 Minn. 110, 54 N. W. 942	143
Brannigan v. Union Gold Min. Co. (C. C.) 93 Fed. 164	263	Caha v. U. S., 152 U. S. 211, 14 Sup. Ct. 513, 38 L. Ed. 415	271
Brennan v. Titusville, 153 U. S. 289, 14 Sup. Ct. 829, 38 L. Ed. 719	714	Caldwell v. North Carolina, 187 U. S. 622, 632, 23 Sup. Ct. 229, 233, 47 L. Ed. 336	713
Bresnahan v. Tripp Giant Leveler Co., 72 Fed. 920, 19 C. C. A. 237	618	Callan v. Wilson, 127 U. S. 540-555, 8 Sup. Ct. 1301, 32 L. Ed. 223	78
Brewer v. Boston Theater, 104 Mass. 378	613	Cambridge v. Railroad Com'rs, 153 Mass. 161, 170, 26 N. E. 241	888
Bridge Proprietors v. Hoboken Co., 68 U. S. 116, 145, 17 L. Ed. 571	575	Camfield v. U. S., 167 U. S. 518, 524, 17 Sup. Ct. 864, 42 L. Ed. 260	272
Bristol, etc., Co. v. Maggs, 44 Ch. Div. L. R. 618	952	Campbell v. Duluth S. S. & A. R. Co. (C. C.) 50 Fed. 241	768
British Queen Min. Co. v. Baker Silver Min. Co., 139 U. S. 222, 11 Sup. Ct. 523, 35 L. Ed. 147	984	Campbell v. Golden Cycle Min. Co., 141 Fed. 610, 613, 73 C. C. A. 260	93
Broach v. Powell, 79 Ga. 79, 81, 3 S. E. 763	615	Campbell v. Railroad Co., 1 Woods, 369, Fed. Cas. No. 2366	480
Brobst v. Brock, 10 Wall. 519, 18 L. Ed. 387	177	Canal Co. v. Clark, 13 Wall. 327, 20 L. Ed. 581	214
Brockaway v. Thomas, 32 Ark. 311	973	Canal Co. v. Harris, 101 Pa. 80	669
Bronson v. Schulten, 104 U. S. 410, 26 L. Ed. 797	325	Cannon, In re (D. C.) 121 Fed. 582	300
Brooks v. U. S., 76 C. C. A. 581, 146 Fed. 223	957	Car Coupler Co. v. League, 25 Colo. 129, 54 Pac. 642	973
Brown, Matter of, 154 N. Y. 313, 325, 48 N. E. 537	469	Carlson v. Cincinnati, S. & M. R. Co., 120 Mich. 481, 79 N. W. 688	40
Brown v. Cornell Steamboat Co. (D. C.) 110 Fed. 780	317	Carnegie, Phipps & Co. v. Hulbert, 70 Fed. 209, 16 C. C. A. 498	972
Brown v. Fletcher, 210 U. S. 82, 28 Sup. Ct. 702, 704, 705, 52 L. Ed. 966	822	Carnegie Steel Co. v. Cambria Iron Co., 185 U. S. 403, 424-425, 22 Sup. Ct. 698, 46 L. Ed. 968	854
Brown v. Foster, 113 Mass. 136, 18 Am. Rep. 463	600	Carr v. Duval, 14 Pet. 77, 10 L. Ed. 361	627
Brown v. Major, 164 Fed. 673	685	Carroll v. Greenwich Ins. Co., 199 U. S. 401-410, 26 Sup. Ct. 66, 50 L. Ed. 246	229
Brown v. Piper, 91 U. S. 37, 41, 42, 23 L. Ed. 200	184	Carroll v. Lessee of Carroll, 16 How. 275, 14 L. Ed. 936	577
Brown v. Walker (C. C.) 70 Fed. 46	694	Carroll Co. v. Smith, 111 U. S. 556, 4 Sup. Ct. 539, 28 L. Ed. 517	550
Brown Chemical Co. v. Meyer, 139 U. S. 544, 11 Sup. Ct. 625, 35 L. Ed. 247	1002	Carson & Rand Lumber Co. v. Holtzclaw (C. C.) 39 Fed. 578	359
Bryan v. Bernheimer, 181 U. S. 188, 195, 196, 21 Sup. Ct. 557, 45 L. Ed. 814	826	Cashman, In re (D. C.) 103 Fed. 67	691
Buffalo Gas Co. v. Buffalo (C. C.) 156 Fed. 370, 371	889	Cattle Raisers' Ass'n of Texas v. Missouri, K. & T. R. Co., 11 Interst. Com. R. 296; 13 Interst. Com. R. 418	647
Bullock Electric Co. v. Westinghouse Electric Co., 129 Fed. 105, 63 C. C. A. 607	872	Cause Mfg. Co. v. U. S., 151 Fed. 4, 80 C. C. A. 461, T. D. 27, 751	911
Burchard, The (D. C.) 42 Fed. 608	899		
Burck v. Taylor, 152 U. S. 634, 14 Sup. Ct. 696, 38 L. Ed. 578	50		
Burgess v. Converse, 2 Curt. 216, Fed. Cas. No. 2,154	101		

	Page		Page
Cavender v. Waddingham, 2 Mo. App. 551, 554.....	988	City of Bradford v. New York & P. Tel. & Tel. Co., 206 Pa. 582, 56 Atl. 41.....	579
Cawood v. Wolfley, 56 Kan. 281, 43 Pac. 236, 31 L. R. A. 538, 54 Am. St. Rep. 590.....	515	City of Georgetown v. Alexandria Canal Co., 12 Pet. 91, 98, 9 L. Ed. 1012.....	84
Central Coal & Coke Co. v. Good, 120 Fed. 793, 57 C. C. A. 161.....	79	City of Greeley v. Hamman, 12 Colo. 94, 96, 20 Pac. 1.....	176
Central v. Georgia R. Co. v. Wright, 207 U. S. 137, 28 Sup. Ct. 47, 52 L. Ed. 137.....	761	City of Memphis v. Postal Tel. & Cable Co., 145 Fed. 602, 76 C. C. A. 292.....	601
Centurion, The, Fed. Cas. No. 2,554.....	106	City of Newton v. Levis, 79 Fed. 715, 25 C. C. A. 161.....	893
Chaffraix v. Board of Liquidation (C. C.) 11 Fed. 638.....	19	City of Toledo v. Western Union Tel. Co., 107 Fed. 10, 46 C. C. A. 111, 52 L. R. A. 730.....	571
Charkieh, The, L. R. 4 Ad. & Ec. 59, 74, 86.....	185	City of Wichita v. Old Colony Trust Co., 132 Fed. 641, 649, 66 C. C. A. 19.....	571, 578, 579
Charnley v. Sibley, 73 Fed. 981, 20 C. C. A. 157.....	979	Clapp v. Mason, 94 U. S. 589, 592, 24 L. Ed. 212.....	466, 800
Chase v. Driver, 92 Fed. 780, 784, 34 C. C. A. 668, 672.....	842	Clark v. Barnard, 108 U. S. 436-455, 27 L. Ed. 780.....	597
Chattanooga, R. & S. R. Co. v. Downs, 106 Fed. 641, 45 C. C. A. 511.....	793	Clark v. Blair (C. C.) 14 Fed. 813.....	903
Cherokee Nation v. Hitchcock, 187 U. S. 295, 23 Sup. Ct. 115, 47 L. Ed. 183.....	672	Clark v. Garfield, 8 Allen (Mass.) 427.....	687
Cherokee Nation v. South Kansas R. Co., 135 U. S. 657, 10 Sup. Ct. 971, 34 L. Ed. 295.....	253	Clark v. Geer, 86 Fed. 447, 32 C. C. A. 295.....	412, 413
Cherokee & P. Coal & M. Co. v. Wilson, 47 Kan. 460, 28 Pac. 178.....	667	Clark v. Thompson, 47 Ill. 25, 95 Am. Dec. 457.....	969
Chesapeake, O. & S. W. R. Co. v. Higgins, 85 Tenn. 620, 622, 4 S. W. 47.....	263, 269	Clark v. Zarniko, 106 Fed. 607, 608, 45 C. C. A. 494, 496.....	830
Chesapeake & O. Fuel Co. v. U. S., 115 Fed. 610, 53 C. C. A. 256.....	721	Clarkson v. Manson (C. C.) 4 Fed. 257.....	359
Chesapeake & O. R. Co. v. King, 99 Fed. 251, 40 C. C. A. 432, 49 L. R. A. 102.....	793	Clement v. Cash, 21 N. Y. 253.....	307
Chicago, B. & Q. Ry. v. Babcock, 204 U. S. 585, 27 Sup. Ct. 326, 51 L. Ed. 636.....	765	Clement v. Insurance Co., 7 Blatchf. 51, Fed. Cas. No. 2,882.....	652
Chicago, etc., Co. v. Fosdick, 106 U. S. 47-71, 1 Sup. Ct. 10, 27 L. Ed. 47.....	758	Clitherall v. Ogilvie, 1 Desaus. 250.....	115
Chicago, etc., Co. v. Johnston, 89 Ind. 88.....	972	Clune v. U. S., 159 U. S. 590, 16 Sup. Ct. 125, 40 L. Ed. 269.....	78
Chicago Great Western R. Co. v. Roddy, 131 Fed. 712, 713, 65 C. C. A. 470, 471.....	830	Clyde v. Richmond & D. R. Co. (C. C.) 55 Fed. 445.....	756
Chicago Great Western R. Co. v. Smith, 73 C. C. A. 164, 141 Fed. 930.....	43	Coats v. Merrick Thread Co., 149 U. S. 562, 572, 573, 13 Sup. Ct. 966, 37 L. Ed. 847.....	1003, 1004
Chicago, R. I. & P. R. Co. v. Crisman, 19 Colo. 30, 34 Pac. 286.....	43, 44	Cobb v. Overman, 6 Am. Bankr. Rep. 324, 109 Fed. 65, 48 C. C. A. 223, 54 L. R. A. 369.....	488
Chicago, R. I. & P. R. Co. v. Groves, 56 Kan. 601, 44 Pac. 628.....	414	Cochrane v. Deener, 94 U. S. 780, 24 L. Ed. 139.....	854
Chicago, R. I. & P. R. Co. v. Martin, 59 Kan. 437, 53 Pac. 461.....	414	Cockrill v. Stafford, 102 Mo. 57, 14 S. W. 813.....	320
Chicago, R. I. & P. R. Co. v. Posten, 59 Kan. 449, 53 Pac. 465.....	414	Coder v. McPherson, 18 Am. Bankr. Rep. 523, 152 Fed. 951, 82 C. C. A. 99.....	454
Chicago & N. W. R. Co. v. Andrews, 130 Fed. 65, 73, 74, 64 C. C. A. 399, 407, 408; 195 U. S. 628, 25 Sup. Ct. 787, 49 L. Ed. 351.....	39, 43, 829, 830.	Coffin v. Ogden, 18 Wall. 120, 21 L. Ed. 821.....	193
Childs v. New York Times Co. (C. C.) 110 Fed. 527.....	782	Cohen, Matter of (D. C.) 131 Fed. 391.....	280
Chin Bak Kan v. U. S., 186 U. S. 193, 200, 22 Sup. Ct. 891, 46 L. Ed. 1121.....	330	Cohen v. U. S., 85 C. C. A. 113, 157 Fed. 651.....	158
Christianson v. Chicago, St. P., M. & O. R. Co., 67 Minn. 94, 69 N. W. 640.....	794	Cohens v. Virginia, 19 U. S. (6 Wheat.) 264, 5 L. Ed. 257.....	115
Chunn v. City & S. R. Co., 207 U. S. 302, 309, 28 Sup. Ct. 63, 52 L. Ed. 219.....	43	Cole v. Cunningham, 133 U. S. 107, 10 Sup. Ct. 269, 33 L. Ed. 538.....	871
Cimiotti Co. v. American Fur Co., 198 U. S. 399, 414, 25 Sup. Ct. 697, 49 L. Ed. 1100.....	999	Coles v. Trecothick, 9 Vesey, 246.....	114
		Cole & Co. v. Stauffer, 17 Am. Bankr. Rep. 577, 148 Fed. 981, 78 C. C. A. 609.....	494
		Collin Co. Nat. Bank v. Hughes, 152 Fed. 414, 416, 81 C. C. A. 556, 558.....	842
		Colorado Midland R. Co. v. Jones (C. C.) 29 Fed. 193.....	744
		Colorado & S. R. Co. v. Thomas, 33 Colo. 517, 81 Pac. 801, 70 L. R. A. 681.....	43
		Commercial Acetylene Co. v. Avery Co. (C. C.) 152 Fed. 642.....	89

	Page		Page
Commercial Ins. Co. v. Robinson, 64 Ill. 265, 16 Am. Rep. 557	409	Cunningham v. German Ins. Bank, 101 Fed. 977, 41 C. C. A. 609; 4 Am. Bankr. Rep. 192, 103 Fed. 932, 43 C. C. A. 377	314
Commissioners v. Clark, 94 U. S. 278, 284, 24 L. Ed. 59	177	Curtis, Matter of, 142 N. Y. 219, 222, 36 N. E. 887	165
Commissioners of Wyandotte Co. v. Abbott, 52 Kan. 148, 34 Pac. 416	741	Dalzell v. Dueber Mfg. Co., 149 U. S. 315, 320, 13 Sup. Ct. 886, 37 L. Ed. 749	63
Commonwealth v. New York, L. E. & W. R. Co., 132 Pa. 591, 19 Atl. 291, 7 L. R. A. 634	253	David v. Southwestern R. Co., 41 Ga. 223	309
Compton v. Jesup, 68 Fed. 263, 289, 313, 15 C. C. A. 397	758	Davidson v. Lanier, 4 Wall. 447, 18 L. Ed. 377	687
Connolly v. Ross (D. C.) 11 Fed. 342	317	Davidsson v. Hill (1901) 2 K. B. Div. 606 264, 267, 268	
Conrad v. U. S., 127 Fed. 800, 62 C. C. A. 478	78	Davies v. Arthur, 96 U. S. 148, 24 L. Ed. 758	101
Consolidated Gas Co. v. Mayer (C. C.) 146 Fed. 150	885, 889, 891, 892, 893	Davis v. A. Booth & Co., 131 Fed. 37, 65 C. C. A. 269	718
Consolidated Min. Co. v. Fogo, 104 Wis. 97, 80 N. W. 103	137	Davis v. Keyes, 38 N. Y. 94	375
Consolidated Vinegar Co. v. Brew, 112 Wis. 610, 612, 88 N. W. 603	64	Davis v. Pacific Tel. & Tel. Co., 127 Cal. 313, 57 Pac. 767, 59 Pac. 698	573, 574
Continental Ins. Co. v. Rhoads, 119 U. S. 237, 7 Sup. Ct. 193, 30 L. Ed. 380	972	Davis v. Patrick, 122 U. S. 138, 7 Sup. Ct. 1102, 30 L. Ed. 1090	535
Contra Costa Water Co. v. Oakland, 165 Fed. —	889	Davis v. Schwartz, 155 U. S. 631, 633, 637, 15 Sup. Ct. 237, 39 L. Ed. 289	821
Conwell's Adm'r v. Heavilo's Adm'r, 5 Har. (Del.) 296	468	Day v. Woodworth, 13 How. 371, 14 L. Ed. 181	549
Cook v. Foley, 81 C. C. A. 237, 152 Fed. 41	177	Dealy v. U. S., 152 U. S. 539, 14 Sup. Ct. 680, 38 L. Ed. 545	158
Cook v. Hart, 146 U. S. 183, 13 Sup. Ct. 40, 36 L. Ed. 934	636	De Bara, In re, 179 U. S. 316, 21 Sup. Ct. 110, 45 L. Ed. 207	896
Cook v. Moore, 11 Cush. (Mass.) 213	139	Debs, In re, 158 U. S. 564, 587, 15 Sup. Ct. 900, 907, 39 L. Ed. 1092	85, 256, 353
Cook v. Tullis, 85 U. S. 332, 21 L. Ed. 933	1011	Deering v. Harvester Works, 155 U. S. 286, 295, 15 Sup. Ct. 118, 39 L. Ed. 153	557
Cooke, Case of, 91 U. S. 389, 23 L. Ed. 237	160	Deffebach v. Hawke, 115 U. S. 407, 6 Sup. Ct. 102, 29 L. Ed. 423	439
Cooley v. Port Wardens, 12 How. 299, 13 L. Ed. 996	353	Defiance Water Co. v. Defiance, 191 U. S. 184, 190, 24 Sup. Ct. 63, 48 L. Ed. 140	605
Coolman v. Fleming, 82 Ind. 117, 121	972	De Gottardi, In re (D. C.) 114 Fed. 332	752
Cooper v. Omohundro, 19 Wall. 65, 69, 22 L. Ed. 47	652	Delafeld v. Shipman, 18 Abb. N. C. (N. Y.) 300	468
Coopersville Co-operative Creamery Co. v. Lemon, 163 Fed. 145	273	De Lamar's Nevada G. M. Co. v. Nesbitt, 177 U. S. 523, 20 Sup. Ct. 715, 44 L. Ed. 872	607
Courier-Journal Job Printing Co. v. Shaefer-Meyer Brewing Co., 101 Fed. 699, 41 C. C. A. 614	312	Delaware, etc., Co. v. Converse, 139 U. S. 469, 476, 11 Sup. Ct. 569, 35 L. Ed. 213	176
Covell v. Heyman, 111 U. S. 176, 4 Sup. Ct. 355, 28 L. Ed. 390	771	Dellapizza v. Foley, 112 Cal. 380, 44 Pac. 727	374, 375
Coweta Fertilizer Co. v. Brown (C. C. A.) 163 Fed. 162	805	Deni v. Pennsylvania R. Co., 181 Pa. 525, 37 Atl. 558, 59 Am. St. Rep. 676	263, 264, 268
Cowley v. Northern Pac. Co., 159 U. S. 569-583, 16 Sup. Ct. 127, 40 L. Ed. 263	768	Denning, In re (D. C.) 8 Am. Bankr. Rep. 133, 134, 114 Fed. 219, 220	512
Coxe Bros. & Co. v. Lehigh Val. R. Co., 3 Interst. Com. R. 460	247	Dennis v. Superior Court, 91 Cal. 548, 27 Pac. 1031	683
Creagh v. Equitable Life Ass'n (C. C.) 83 Fed. 849	768	Denver & R. G. R. Co. v. Spencer, 25 Colo. 9, 52 Pac. 211	44
Creede & Cripple Creek Min. & Mill. Co. v. Uinta Tunnel Min. & Transp. Co., 196 U. S. 337, 345, 353, 25 Sup. Ct. 266, 49 L. Ed. 501	536	Deuell, In re (D. C.) 100 Fed. 635	691
Crossley v. Maycock, 18 Eq. Cas. 180	952	Devine v. Los Angeles, 202 U. S. 313, 322, 26 Sup. Ct. 652, 657, 50 L. Ed. 1046	606
Crossman v. Pendery (C. C.) 8 Fed. 693	536	Dewees v. Manhattan Ins. Co., 34 N. J. Law, 253	904
Cross v. Wilson, 52 Ark. 312, 12 S. W. 576	968	Dewey v. Moyer, 72 N. Y. 70	623
Cucciarre v. New York Cent. & H. R. R. Co. (C. C. A.) 163 Fed. 38-41	768	Dewey v. West Fairmont Gas Co., 123 U. S. 329, 333, 8 Sup. Ct. 148, 31 L. Ed. 179	92, 93
Cullen v. Baltimore & P. R. Co., 8 App. D. C. 69	43	Dick v. Foraker, 155 U. S. 404, 15 Sup. Ct. 124, 39 L. Ed. 201	968
Culp v. U. S., 27 C. C. A. 294, 82 Fed. 990	956	Dimick v. Metropolitan Life Ins. Co., 67 N. J. Law, 373, 374, 51 Atl. 692	904
Cumberland Tel. & Tel. Co. v. Evansville (C. C.) 127 Fed. 186, 187	570, 571		
Cunningham v. Cleveland, 98 Fed. 657, 660, 39 C. C. A. 211	98		

	Page		Page
Dirst v. Morris, 14 Wall. 484, 20 L. Ed. 722	651	Emack v. Kane (C. C.) 34 Fed. 46	84
Disston v. McClain, 147 Fed. 114, 116, 77 C. C. A. 340	467	Empire State Nail Co. v. American S. L. Button Co. (C. C.) 61 Fed. 650	196
Dittgen v. Racine Paper Goods Co., 164 Fed. 84	87	Employer's Liability Cases, 207 U. S. 463, 28 Sup. Ct. 141, 52 L. Ed. 297	351
Dobbins v. Los Angeles, 195 U. S. 223, 25 Sup. Ct. 18, 49 L. Ed. 169	236	Engels' Estate, In re, 166 Pa. 280, 31 Atl. 76, 78	468
Dr. Miles Medical Co. v. Jaynes Drug Co. (C. C.) 149 Fed. 838	806	England v. Gebhardt, 112 U. S. 502, 503, 5 Sup. Ct. 287, 28 L. Ed. 811	984
Dodge v. State Bank, 2 A. K. Marsh. (Ky.) 612	535	Enoch Morgan's Sons Co. v. Wendover (C. C.) 43 Fed. 420, 10 L. R. A. 283	214
Dodge v. Woolsey, 18 How. 331, 15 L. Ed. 401	757	Equitable Life Assur. Soc. v. McElroy, 83 Fed. 631, 28 C. C. A. 365	627
Doherr v. Houston (D. C.) 123 Fed. 334, 335; 128 Fed. 594, 64 C. C. A. 102	346	Erhardt v. Hahn, 55 Fed. 273, 5 C. C. A. 99	206
Donaldson v. Farwell, 93 U. S. 631, 633, 23 L. Ed. 993	136	Erie Lumber Co., In re (D. C.) 150 Fed. 817	653
Donnell v. Columbia Ins. Co., Fed. Cas. No. 3,987	811	Ervin, In re (D. C.) 109 Fed. 135	512
Donovan v. Construction Syndicate (1893) 1 Q. B. 629	790	Escondido Oil, etc., Co. v. Glaser, 144 Cal. 494, 77 Pac. 1040	307
Dooley v. Pease, 180 U. S. 126, 21 Sup. Ct. 329, 45 L. Ed. 457	983	Eudora, The (D. C.) 110 Fed. 430	899
Dougherty v. U. S., 108 Fed. 56, 60, 47 C. C. A. 195, 199	774	Eureka County Bank v. Clarke, 130 Fed. 326, 64 C. C. A. 571	983
Douglas v. Kentucky, 168 U. S. 488, 18 Sup. Ct. 199, 42 L. Ed. 553	239	Evans v. Gee, 14 Pet. 1, 10 L. Ed. 327	693
Dow v. Gould & Curry S. M. Co., 31 Cal. 629, 650	535	Evans v. U. S., 153 U. S. 587, 14 Sup. Ct. 936, 38 L. Ed. 830	773
Dred Scott v. Sanford, 19 How. 393, 15 L. Ed. 691	576	Fairfield v. Baldwin, 12 Pick. (Mass.) 388	143
Duluth v. Duluth Tel. Co., 84 Minn. 486, 87 N. W. 1127	578	Fairfield v. Gallatin Co., 100 U. S. 47, 25 L. Ed. 544	573
Duncan v. Atchison, T. & S. F. R. Co., 72 Fed. 808, 812, 19 C. C. A. 202	323, 324	Fairly v. Kline, 3 N. J. Law, 754, 758, 4 Am. Dec. 414	468
Dunn v. Clarke, 8 Pet. 1, 8 L. Ed. 845	97	Falk v. Curtis Pub. Co. (C. C.) 102 Fed. 967; 107 Fed. 126, 46 C. C. A. 201	782
Durland v. U. S., 161 U. S. 306, 313, 16 Sup. Ct. 508, 40 L. Ed. 709	958	Falls Wire Co. v. Broderick (C. C.) 6 Fed. 654	359
Durston v. Pollock, 91 Iowa, 668, 60 N. W. 221	822	Farmers' Loan & Trust Co. v. Lake St. R. Co., 177 U. S. 51, 20 Sup. Ct. 564, 44 L. Ed. 667	771
Eachus v. Broomall, 115 U. S. 420, 434, 6 Sup. Ct. 229, 29 L. Ed. 419	694	Farmers' Loan & Trust Co. v. Toledo, etc., R. Co., 67 Fed. 53	756
Earle v. Carson, 188 U. S. 42, 23 Sup. Ct. 254, 47 L. Ed. 373	832	Farquhar v. National Harrow Co., 102 Fed. 714, 42 C. C. A. 600, 49 L. R. A. 755	84
Eastlack, In re (D. C.) 145 Fed. 68	286	Fay v. Ft. Collins, 40 Colo. 262, 90 Pac. 512	176
Eau Claire v. Payson, 109 Fed. 676, 48 C. C. A. 608	98	Fellenzer v. Van Valzah, 95 Ind. 128	811
Eck v. Kutz (C. C.) 132 Fed. 758	194	Feller v. Clark, 36 Minn. 338, 340, 31 N. W. 175	969
Eckstein, In re, G. A. 5,822, T. D. 26,462	65, 70	Fellerman, In re (D. C.) 149 Fed. 244, 17 Am. Bankr. Rep. 785	74
Edison Elec. Co. v. Thackara Mfg. Co., 167 Pa. 530, 31 Atl. 856	424	Ferguson v. Hillman, 55 Wis. 181, 190, 12 N. W. 389	143
Eidman v. Martinez, 184 U. S. 578, 583, 22 Sup. Ct. 515, 46 L. Ed. 697	163	Field v. Clark, 143 U. S. 649, 691, 12 Sup. Ct. 495, 36 L. Ed. 294	271
Eidman v. Tilghman, 69 C. C. A. 130, 136 Fed. 141; 203 U. S. 580, 27 Sup. Ct. 779, 51 L. Ed. 326	801	Field v. Siegel, 99 Wis. 605, 75 N. W. 397, 47 L. R. A. 433	136
Elgin Nat. Watch Co. v. Illinois Watch Case Co., 179 U. S. 665, 21 Sup. Ct. 270, 45 L. Ed. 365	94	Field v. U. S., 137 Fed. 6, 69 C. C. A. 568	157
Eliason v. Henshaw, 4 Wheat. 225, 228, 4 L. Ed. 556	627	Finkelstein, In re (D. C.) 101 Fed. 418	692
Elliott v. Chicago, M. & St. P. R. Co., 150 U. S. 245, 14 Sup. Ct. 85, 37 L. Ed. 1068	40, 793	First Nat. Bank, In re, 152 Fed. 65, 81 C. C. A. 260	825
Elwine Kreplin, The, 9 Blatchf. 438, Fed. Cas. No. 4,426	899	First Nat. Bank v. Staake, 202 U. S. 141, 26 Sup. Ct. 580, 50 L. Ed. 967	555
Ely v. Tallman, 14 Wis. 28	969	First Nat. Bank of Chicago v. Chicago Title & Trust Co., 198 U. S. 280, 25 Sup. Ct. 693, 49 L. Ed. 1051	416, 824
164 F.—b		Flash v. Conn. 109 U. S. 371, 3 Sup. Ct. 263, 27 L. Ed. 966	679
		Fleming v. Lay, 109 Fed. 952-955, 48 C. C. A. 748	547

	Page		Page
Fleming v. People, 27 N. Y. 329.....	553	Gerson, In re (D. C.) 2 Am. Bankr. Rep. 170.....	486
Fletcher v. Peck, 6 Cranch, 126, 3 L. Ed. 162.....	251	Gibbons v. Ogden, 9 Wheat. (U. S.) 1, 194, 196, 6 L. Ed. 23.....	356
Flick, In re (D. C.) 105 Fed. 503.....	143	Gibson v. Lyon, 115 U. S. 439, 6 Sup. Ct. 129, 29 L. Ed. 440.....	550
Florida Cent., etc., R. v. Bell, 176 U. S. 321, 20 Sup. Ct. 399, 44 L. Ed. 486.....	607	Gibson v. Oliver, 158 Pa. 277, 27 Atl. 961.....	308
Florida Cent. & P. R. Co. v. Reynolds, 183 U. S. 476, 22 Sup. Ct. 176, 46 L. Ed. 283.....	762	Gibson v. Thornton, 107 Ga. 562, 33 S. E. 896.....	493
Floyd Acceptance, The, 7 Wall. 666, 19 L. Ed. 169.....	160	Gilbert v. Burlington & C. R. R. Co., 128 Fed. 529, 532, 533, 63 C. C. A. 27, 30, 31.....	830
Fonda, Ex parte, 117 U. S. 516, 6 Sup. Ct. 848, 29 L. Ed. 994.....	636	Gilbert v. Erie R. Co., 38 C. C. A. 408, 97 Fed. 747.....	43
Fonda v. St. Paul City R. Co., 71 Minn. 438, 451, 74 N. W. 166, 70 Am. St. Rep. 341.....	43	Gill v. Austin, 84 C. C. A. 677, 157 Fed. 234.....	802
Fourth St. Bank v. Yardley, 165 U. S. 634, 17 Sup. Ct. 439, 41 L. Ed. 855.....	187	Gilmore v. Norton, 10 Kan. 504.....	740
Fox, In re (D. C.) 51 Fed. 427, 430.....	635, 637	Gird v. California Oil Co. (C. C.) 60 Fed. 531, 545.....	538
Fox v. Patton (D. C.) 22 Fed. 746.....	106	Glidden v. Harrington, 189 U. S. 253, 23 Sup. Ct. 574, 47 L. Ed. 798.....	764
Francis v. Flinn, 118 U. S. 385, 388, 6 Sup. Ct. 1148, 30 L. Ed. 165.....	84, 87	Gloucester Ferry Co. v. Pennsylvania, 114 U. S. 196, 203, 5 Sup. Ct. 826, 828, 29 L. Ed. 158.....	712
Frank & Dugan v. Herold, 63 N. J. Eq. 445, 52 Atl. 155.....	516	Gonzales, Case of, 192 U. S. 1, 24 Sup. Ct. 177, 48 L. Ed. 317.....	154
Frazer v. Moffit (C. C.) 20 Blackf. 267, 18 Fed. 584.....	69	Good v. Norley, 28 Iowa. 188.....	969
Frazer v. Southern Loan & Trust Co., 99 Fed. 707, 40 C. C. A. 76.....	592	Goodwin v. Sharkey, 80 Pa. 149.....	487
Fredericks v. Fasnacht, 30 La. Ann. 117.....	950	Goodyear's India Rubber Glove Mfg. Co. v. Goodyear Rubber Co., 128 U. S. 604, 9 Sup. Ct. 166, 32 L. Ed. 535.....	214
Fremont v. U. S., 17 How. 542, 557, 15 L. Ed. 241.....	184	Goodyear Tire & Rubber Co. v. Rubber Tire Wheel Co., 116 Fed. 363, 53 C. C. A. 583.....	870
French Republic v. Saratoga Springs Vichy Co., 191 U. S. 427, 24 Sup. Ct. 145, 48 L. Ed. 247.....	214	Governor of Georgia v. Madrazo, 1 Pet. 110, 7 L. Ed. 73.....	18
Furrer v. Ferris, 145 U. S. 132, 134, 12 Sup. Ct. 821, 36 L. Ed. 649.....	665	Grain Rates of Chicago G. W. R. Co., 7 Interst. Com. R. 33.....	247
Griffin v. Page, 18 Wall. 350, 366, 21 L. Ed. 959.....	968	Grand Trunk R. Co. v. Baird, 36 C. C. A. 574, 94 Fed. 946.....	40
Gardiner, In re (C. C.) 72 Fed. 494.....	206	Granger v. Judge, 44 Mich. 384, 6 N. W. 848.....	972
Gardner v. Collector, 6 Wall. 419, 511, 18 L. Ed. 890.....	184	Graven v. MacLeod, 92 Fed. 846, 35 C. C. A. 47.....	793
Gardner v. Detroit St. R. Co., 99 Mich. 182, 58 N. W. 49.....	176	Greene v. Bishop, 1 Cliff. 186, Fed. Cas. No. 5,763.....	811
Garland, Ex parte, 71 U. S. 333, 18 L. Ed. 366.....	258	Greenwald, In re (D. C.) 99 Fed. 705.....	516
Garlich v. Northern Pac. R. Co., 131 Fed. 837, 840, 67 C. C. A. 237, 240.....	176, 829	Gregory v. Bartlett, 55 Ark. 30, 35, 17 S. W. 344.....	968
Garrison, In re, 17 Am. Bankr. Rep. 832, 149 Fed. 178, 79 C. C. A. 126.....	302	Grier v. Wilt, 120 U. S. 412, 7 Sup. Ct. 718, 30 L. Ed. 712.....	694
Garthe v. Hart, 73 Cal. 541, 15 Pac. 93.....	536	Griffin v. Colver, 16 N. Y. 493, 69 Am. Dec. 718.....	985
Garven v. Chicago, R. I. & P. R. Co., 100 Mo. App. 617, 75 S. W. 193.....	414	Griffin v. McGavin, 117 Mich. 372, 75 N. W. 1061, 72 Am. St. Rep. 564.....	972
Gasque v. Small, 2 Stroob. Eq. 72.....	116	Griffith v. Spratley, 1 Cox Ch. Cas. 388.....	114
Gayler v. Wilder, 10 How. 496, 13 L. Ed. 504.....	193	Grignon's Lessee v. Astor, 2 How. 319, 337, 11 L. Ed. 283.....	819
Gemmell v. Swain, 28 Mont. 331, 72 Pac. 662, 98 Am. St. Rep. 570.....	536	Gribsby v. Purcell, 99 U. S. 505, 25 L. Ed. 354.....	839
Georgia v. Jesup, 106 U. S. 458, 1 Sup. Ct. 363, 27 L. Ed. 316.....	20	Grimm v. U. S., 156 U. S. 604, 15 Sup. Ct. 470, 39 L. Ed. 550.....	261
Georgia v. Tennessee Copper Co., 206 U. S. 230, 238, 240, 27 Sup. Ct. 618, 619, 620, 51 L. Ed. 1038.....	941, 942	Grin v. Shine, 187 U. S. 181, 23 Sup. Ct. 98, 47 L. Ed. 130.....	784
German-American Filter Co. v. Erdrich (C. C.) 98 Fed. 300.....	855	Grove v. Dubois, 1 T. R. 112, 115.....	105
German-American Filter Co. of New York v. Loew Filter Co. (C. C.) 103 Fed. 303.....	861	Guarantee Gold Bond Loan & Savings Co. v. Edwards (Ind. T.) 104 S. W. 624.....	812
German Fire Ins. Co. v. Roost, 55 Ohio St. 581, 45 N. E. 1097, 36 L. R. A. 236, 60 Am. St. Rep. 711.....	408	Guiding Star, The (D. C.) 9 Fed. 521; (C. C.) 18 Fed. 263.....	105
		Gulf, C. & S. F. R. Co. v. Ellis, 165 U. S. 150, 154, 17 Sup. Ct. 255, 41 L. Ed. 666.....	231

	Page		Page
Gunter v. Atlantic Coast Line, 200 U. S. 273, 26 Sup. Ct. 252, 50 L. Ed. 477....	20	Hayward v. National Bank, 96 U. S. 611, 618, 24 L. Ed. 855.....	322
Haddock v. Delaware, L. & W. R. Co., 3 Interst. Com. R. 302.....	247	Haywood v. Cope, 25 Beav. 140.....	112
Haddock v. Haddock, 201 U. S. 562, 26 Sup. Ct. 525, 50 L. Ed. 867.....	283	Head v. Hargrave, 105 U. S. 45, 26 L. Ed. 1028.....	542
Haff, In re, 136 Fed. 78, 80, 68 C. C. A. 646.....	685	Healy v. Aultman & Co., 6 Neb. 349.....	973
Hafner v. St. Louis Transit Co., 197 Mo. 196, 94 S. W. 291.....	43	Heath v. Whidden, 29 Me. 108.....	973
Hager v. Reclamation Dist., 111 U. S. 701, 4 Sup. Ct. 663, 28 L. Ed. 569.....	764	Heidenrich v. Heidenrich, 18 Ill. App. 142	535
Hagop Bogigian Co., In re (C. C.) 104 Fed. 75.....	101	Heidritter v. Elizabeth Oilcloth Co., 112 U. S. 294, 5 Sup. Ct. 135, 28 L. Ed. 729..	771
Hahn v. U. S., 100 Fed. 635, 40 C. C. A. 622.....	71	Heister v. Fortner, 2 Bin. (Pa.) 40, 4 Am. Dec. 417.....	50
Hall v. Lanning, 91 U. S. 160, 23 L. Ed. 271.....	283	Henderson, In re (D. C.) 16 Am. Bankr. Rep. 91, 94, 142 Fed. 590.....	512
Hall v. Weare, 92 U. S. 728, 23 L. Ed. 500	668	Henry, In re, 123 U. S. 374, 8 Sup. Ct. 142, 31 L. Ed. 174.....	394, 895
Halsted v. Buster, 119 U. S. 341, 7 Sup. Ct. 276, 30 L. Ed. 462.....	972	Henshaw v. Bryant, 5 Ill. 97.....	204
Hamilton Gas L. & C. Co. v. Hamilton, 146 U. S. 258, 13 Sup. Ct. 90, 36 L. Ed. 963	577	Herold v. Shanley, 146 Fed. 20, 76 C. C. A. 478.....	165, 466, 801
Handell, In re, 15 Nat. Bankr. Rep. 71, Fed. Cas. No. 6,017.....	313	Herriman v. Menzies, 115 Cal. 16, 44 Pac. 660, 46 Pac. 730, 35 L. R. A. 318, 56 Am. St. Rep. 81.....	721
Hanley v. U. S., 127 Fed. 929, 62 C. C. A. 561.....	896	Hersey v. Tully, 8 Colo. App. 110, 44 Pac. 854.....	988
Hanna, In re (not reported).....	301	Hersey v. Veazie, 24 Me. 9, 41 Am. Dec. 364.....	613
Hardin v. Boyd, 113 U. S. 756, 5 Sup. Ct. 771, 28 L. Ed. 1141.....	90	Hess, In re (D. C.) 14 Am. Bankr. Rep. 559, 134 Fed. 109.....	293, 294
Hardin v. Jordan, 140 U. S. 371, 11 Sup. Ct. 808, 35 L. Ed. 428.....	976	Hewit v. Berlin Mach. Works, 194 U. S. 296, 24 Sup. Ct. 690, 48 L. Ed. 986.....	824
Harding v. American Glucose Co., 182 Ill. 615, 55 N. E. 577, 64 L. R. A. 738, 74 Am. St. Rep. 189.....	721	Hibbard v. Bailey, 12 Am. Bankr. Rep. 104, 129 Fed. 575, 64 C. C. A. 143.....	488
Harding v. Handy, 11 Wheat. 103, 6 L. Ed. 429.....	280	Hibben v. Smith, 191 U. S. 310, 24 Sup. Ct. 88, 48 L. Ed. 195.....	764
Hardon v. Newton, 14 Blatchf. 376, Fed. Cas. No. 6,054.....	613	Hill v. Francklyn, T. D. 28,856; T. D. 29,074. 162 Fed. 880.....	70
Hardy v. Call, 16 Mass. 530.....	329	Hill v. Mendenhall, 21 Wall. 453, 22 L. Ed. 616.....	283
Hare v. Horton, 5 R. & Ad. 715.....	409	Hill v. Tucker, 13 How. 458, 461, 467, 14 L. Ed. 223.....	821, 822
Hark Bros., In re (D. C.) 14 Am. Bankr. Rep. 624, 136 Fed. 986.....	294	Hill v. Winsor, 118 Mass. 251.....	795
Hark v. C. M. Allen Co., 146 Fed. 665, 668, 77 C. C. A. 91, 94.....	685	Hinckley v. Pittsburg Bessemer Steel Co., 121 U. S. 264, 7 Sup. Ct. 875, 30 L. Ed. 967.....	296
Harriman v. Pullman Palace Car Co., 29 C. C. A. 194, 85 Fed. 353.....	176	Hines, In re (D. C.) 16 Am. Bankr. Rep. 495, 144 Fed. 543.....	130
Harris, In re (D. C.) 15 Am. Bankr. Rep. 705, 117 Fed. 575.....	210	Hinkley v. Arkansas City, 69 Fed. 768, 16 C. C. A. 395.....	984
Harrison v. Stacy, 6 Rob. (La.) 15.....	822	Hitz, Ex parte, 111 U. S. 766, 4 Sup. Ct. 698, 28 L. Ed. 592.....	185
Hartford Ins. Co. v. Chicago, etc., R. Co., 175 U. S. 91, 20 Sup. Ct. 33, 44 L. Ed. 84.....	550	H. Mueller Mfg. Co. v. A. Y. McDonald & Morrison Mfg. Co. (C. C.) 132 Fed. 585.....	1001
Hartranft v. Meyer, 149 U. S. 544, 13 Sup. Ct. 982, 37 L. Ed. 840.....	44	Hobbs v. Gooding, 164 Fed. 91.....	95, 97
Hartranft v. Wiegmann, 121 U. S. 609, 7 Sup. Ct. 1240, 30 L. Ed. 1012.....	68, 206	Hochester v. De la Tour, 2 El. & Bl. 678.....	150
Hastorf v. The Governor (D. C.) 77 Fed. 1000.....	317	Hodge v. Muscatine Co., 196 U. S. 276, 25 Sup. Ct. 237, 49 L. Ed. 477.....	764
Hatch Storage Battery Co. v. Electric Storage Battery Co., 100 Fed. 975, 41 C. C. A. 133.....	618	Hodges v. Sublett, 91 Ala. 588, 8 South. 800.....	950
Hathaway v. Bank, 134 U. S. 494, 10 Sup. Ct. 608, 33 L. Ed. 1004.....	983	Hohorst, In re, 150 U. S. 653-660, 14 Sup. Ct. 221, 37 L. Ed. 1211.....	768, 769
Hayden v. Huff, 62 Neb. 375, 87 N. W. 184, 187.....	842	Holden v. Hardy, 169 U. S. 366, 398, 18 Sup. Ct. 383, 390, 42 L. Ed. 780.....	237
Haynes, In re (C. C.) 30 Fed. 767.....	895	Holden v. Stratton, 198 U. S. 202, 25 Sup. Ct. 656, 49 L. Ed. 1018.....	527
Haynes v. Rice, 33 Tex. 167.....	973	Holmes, In re, 142 Fed. 391, 73 C. C. A. 491.....	824
		Holmes v. Goldsmith, 147 U. S. 150, 164, 13 Sup. Ct. 288, 37 L. Ed. 118.....	139
		Holtgreve v. Wintker, 85 Ill. 472.....	375

	Page		Page
Holy Trinity Church v. U. S., 143 U. S. 457, 461, 462, 463, 12 Sup. Ct. 511, 36 L. Ed. 226.....	261, 517	Interstate Commerce Com. v. Chicago, B. & Q. R. Co., 43 C. C. A. 209, 103 Fed. 249; 186 U. S. 320, 22 Sup. Ct. 824, 46 L. Ed. 1182.....	639, 640, 644
Home Ins. Co. v. Virginia-Carolina Chemical Co. (C. C.) 109 Fed. 681, 686, 687, 93, 97		Iowa Lillooet Gold Min. Co. v. Bliss, 144 Fed. 446.....	766, 769
Hoo Fong v. U. S., 128 Fed. 697, 63 C. C. A. 249.....	330	Irwin v. Hasselman, 97 Fed. 964, 38 C. C. A. 587.....	697
Hooks v. Aldridge, 145 Fed. 865, 869, 76 C. C. A. 409.....	826	Jackson v. Tiernan, 15 La. 485.....	821
Hopkins v. U. S., 171 U. S. 578, 19 Sup. Ct. 40, 43 L. Ed. 290.....	725	Jacobsen v. Siddal, 12 Or. 280, 7 Pac. 108, 53 Am. Rep. 360.....	553
Horn v. Chicago, etc., Co., 38 Wis. 463.....	176	James v. Darby, 100 Fed. 224, 227, 40 C. C. A. 341, 345.....	627
Horn v. Lockhart, 17 Wall. 570, 21 L. Ed. 657.....	480	Jacobs v. Board of Sup'rs, 100 Cal. 121, 130, 34 Pac. 630.....	888
Horn v. People, 26 Mich. 221.....	274	Jacobs v. George, 150 U. S. 415, 14 Sup. Ct. 159, 37 L. Ed. 1127.....	839
Horswell v. Ruiz, 67 Cal. 111, 7 Pac. 197.....	536	James v. Germania Iron Co., 46 C. C. A. 476, 107 Fed. 597.....	644
Hotel Co. v. Wade, 97 U. S. 13, 21, 24 L. Ed. 917.....	480	Janvrin, In re, 174 Mass. 514, 55 N. E. 381, 47 L. R. A. 319.....	888
Howard v. Detroit Stove Works, 150 U. S. 164, 167, 169, 170, 14 Sup. Ct. 68, 37 L. Ed. 1039.....	996, 999	Jaquith v. Alden, 189 U. S. 78, 23 Sup. Ct. 649, 47 L. Ed. 717.....	1013
Howland v. Blake, 97 U. S. 624, 626, 24 L. Ed. 1027.....	812	Jefferson Branch Bank v. Skelley, 66 U. S. 436, 443, 17 L. Ed. 173.....	575, 576
Hoxie v. Price, 31 Wis. 82.....	140	Johanson v. White (C. C. A.) 160 Fed. 901	536
Hoyt v. Smith, 28 Conn. 466, 471.....	973	Jno. D. Park & Sons v. Hartman, 153 Fed. 24, 34, 82 C. C. A. 158, 12 L. R. A. (N. S.) 1135.....	804, 806
Hutchinson v. Otis, 190 U. S. 552, 555, 23 Sup. Ct. 778, 779, 47 L. Ed. 1179.....	314	Johnson v. Hunter, 147 Fed. 133, 137, 77 C. C. A. 359, 363.....	968
Hughes, Ex parte, 114 U. S. 147, 148, 5 Sup. Ct. 823, 29 L. Ed. 134.....	690	Johnson v. Latimer, 71 Ga. 470.....	952
Hughes v. Railroad Co. (D. C.) 93 Fed. 310	317	Johnson v. Macon & W. R. Co., 38 Ga. 433	310
Huling v. Kaw Valley Ry. & Imp. Co., 130 U. S. 559, 9 Sup. Ct. 603, 32 L. Ed. 1045	967	Johnson v. Powers, 139 U. S. 156, 157, 158, 159, 11 Sup. Ct. 525, 35 L. Ed. 112	822
Hunnicut v. Peyton, 102 U. S. 354, 26 L. Ed. 113.....	534	Johnson v. Southern Pac. Co., 196 U. S. 1, 25 Sup. Ct. 158, 49 L. Ed. 363.....	258
Hunt v. Fay, 7 Vt. 170.....	822	Johnson v. Totten, 3 Cal. 343, 58 Am. Dec. 412.....	375
Hurd v. Everett, 1 Paige (N. Y.) 124.....	973	Johnson v. Towsley, 13 Wall. 72, 90, 91, 20 L. Ed. 485.....	644, 918
Hurwood Mfg. Co. v. Wood (C. C.) 138 Fed. 835.....	208	Johnson v. Waters, 111 U. S. 640, 4 Sup. Ct. 619, 28 L. Ed. 547.....	90
Hussey v. Horne-Payne, 4 App. Cas. 311.....	950	Johnson Bros. v. Carter, 120 Iowa, 355, 94 N. W. 850.....	547
Hustace v. Insurance Co., 175 N. Y. 292, 67 N. E. 592, 62 L. R. A. 651.....	408	Joint Traffic Case, 171 U. S. 505, 567, 19 Sup. Ct. 25, 31, 43 L. Ed. 259.....	710
Illinois Cent. R. Co. v. Ackerman, 76 C. C. A. 13, 144 Fed. 959.....	43	Jones v. Clark, 42 Cal. 180.....	375
Illinois Cent. R. Co. v. Ashline, 171 Ill. 313, 49 N. E. 521.....	176	Jones v. U. S., 137 U. S. 202, 214, 216, 11 Sup. Ct. 80, 84, 85, 34 L. Ed. 691.....	184
Imperial Fire Ins. Co. v. Coos Co., 151 U. S. 463, 14 Sup. Ct. 379, 38 L. Ed. 231.....	406	Jordan v. Greig, 33 Colo. 360, 378, 80 Pac. 1045.....	972
Independent Ins. Co., In re, Fed. Cas. Nos. 7,017, 7,018.....	496	Joy v. St. Louis, 201 U. S. 332, 26 Sup. Ct. 478, 50 L. Ed. 776.....	607
India, The, 49 Fed. 76, 1 C. C. A. 174.....	366	Kansas v. Bradley (C. C.) 26 Fed. 239.....	608
Indianapolis Gas. Co. v. Indianapolis (C. C.) 82 Fed. 245.....	893	Kansas v. Colorado, 206 U. S. 46, 117, 27 Sup. Ct. 655, 675, 51 L. Ed. 956.....	941, 942
Inez Min. Co. v. Kinney (C. C.) 46 Fed. 832, 834.....	608	Kansas City v. Metropolitan Water Co. (C. C.) 164 Fed. 723.....	745
Insurance Co. v. Boon, 95 U. S. 117, 24 L. Ed. 395.....	406, 407	Kansas City T. & R. Co. v. Interstate Lumber Co., 37 Fed. 3.....	767
Insurance Co. v. Dunham, 11 Wall. 1, 20 L. Ed. 90.....	105	Kansas Pac. R. Co. v. Dunmeyer, 113 U. S. 629, 640, 641, 644, 5 Sup. Ct. 566, 571, 573, 28 L. Ed. 1122.....	921
Insurance Co. v. Folsom, 13 Wall. 237, 253, 21 L. Ed. 827.....	651	Kanter & Cohen, In re (D. C.) 9 Am. Bankr. Rep. 104, 117 Fed. 356.....	293
Insurance Co. v. Tweed, 7 Wall. 44, 19 L. Ed. 65.....	406	Kaplan, In re (D. C.) 144 Fed. 159.....	826
Insurance Co. v. Wilson, 8 Pet. 291, 304, 305, 8 L. Ed. 949.....	690		
International Coal Min. Co., In re (D. C.) 16 Am. Bankr. Rep. 312, 143 Fed. 665..	494		

	Page		Page
Keasby & Mattison Co., In re, 160 U. S. 221, 16 Sup. Ct. 273, 40 L. Ed. 402....	291	Kollock, In re, 165 U. S. 526, 17 Sup. Ct. 444, 41 L. Ed. 813.....	271, 774
Keck v. U. S., 172 U. S. 434, 19 Sup. Ct. 254, 43 L. Ed. 505.....	780	Krakowski v. U. S. (C. C. A.) 161 Fed. 88....	897
Keefe v. Chicago & N. W. R. Co., 92 Iowa, 182, 60 N. W. 503, 54 Am. St. Rep. 542..	40	Krippendorf v. Hyde, 110 U. S. 276, 287, 4 Sup. Ct. 27, 32, 28 L. Ed. 145.....	93, 97
Keller v. Stolzenbach (C. C.) 20 Fed. 47....	903	Laas v. Scott, 150 Fed. 764, 80 C. C. A. 500.....	196
Kelley v. Boettcher, 29 C. C. A. 14, 21, 85 Fed. 55, 62.....	969	Lake Shore, etc., Co. v. Prentice, 147 U. S. 101, 107, 13 Sup. Ct. 261, 37 L. Ed. 97..	549
Kelley v. Gage Co., 67 Neb. 6, 93 N. W. 194, 99 N. W. 524.....	508	Lamb v. Davenport, 18 Wall. 307, 21 L. Ed. 759.....	919
Kelly v. Pittsburg, 104 U. S. 78, 26 L. Ed. 659.....	764	Lamb v. Lamb, 8 Watts (Pa.) 184.....	468
Kellyville C. Co. v. Petraytis, 195 Ill. 215, 63 N. E. 94, 88 Am. St. Rep. 191.....	263, 264, 268	Lamington, The (D. C.) 87 Fed. 752.....	899
Kelsey v. Crowther, 162 U. S. 404, 16 Sup. Ct. 808, 40 L. Ed. 1017.....	627	La Montague v. T. W. Harvey Lumber Co. (C. C.) 44 Fed. 645.....	359
Kendall v. Winsor, 21 How. 322, 16 L. Ed. 165.....	193	Land, etc., Co. v. McCoach, 129 Fed. 901, 64 C. C. A. 333.....	466
Kennedy v. California Sav. Bank, 97 Cal. 93, 31 Pac. 846, 33 Am. St. Rep. 163....	683	Landsdale v. Daniels, 100 U. S. 113, 117, 25 L. Ed. 587.....	918
Kentucky Life & Acc. Ins. Co. v. Hamilton, 63 Fed. 93, 11 C. C. A. 42.....	984	Langmaid v. Puffer, 7 Gray (Mass.) 378, 382.....	972
Kennedy v. Green, 3 Myl. & K. 722.....	346	Lass v. Scott (C. C.) 145 Fed. 195.....	196
Kern v. Huidekoper, 103 U. S. 485-490, 26 L. Ed. 354.....	769	Latham v. Staten Island R. Co. (C. C.) 150 Fed. 235.....	903
Kessler v. Eldred, 206 U. S. 285, 27 Sup. Ct. 611, 51 L. Ed. 1065.....	871	Latine v. Clements, 3 Ga. 426.....	822
Keystone Mfg. Co. v. Adams, 151 U. S. 139, 143, 14 Sup. Ct. 295, 38 L. Ed. 103....	697	Law Ow Bew v. U. S., 144 U. S. 47, 59, 12 Sup. Ct. 517, 36 L. Ed. 340....	508, 517
Kidd v. Horry (C. C.) 28 Fed. 773.....	84	Lawrence v. Allen, 7 How. 785, 12 L. Ed. 914.....	63, 69
Kidd v. Pearson, 123 U. S. 1, 9 Sup. Ct. 6, 32 L. Ed. 346.....	245	Lawrence v. Lowrie (D. C.) 13 Am. Bankr. Rep. 297, 133 Fed. 995.....	623
Kilbourn v. Thompson, 103 U. S. 168-198, 26 L. Ed. 377.....	283	Law's Estate, In re, 144 Pa. 499, 22 Atl. 831, 14 L. R. A. 103.....	688
Kilburn v. Mullen, 22 Iowa. 498.....	553	Lawton v. Steele, 152 U. S. 133, 137, 14 Sup. Ct. 499, 501, 38 L. Ed. 385.....	237
Kimberly v. Arms, 129 U. S. 512, 516, 524, 9 Sup. Ct. 355, 32 L. Ed. 764....	665, 812	Learned v. Castle, 78 Cal. 454, 18 Pac. 872, 21 Pac. 11.....	497
King v. Gwynn, 14 Fla. 32.....	765	Leary v. Columbia River & P. S. Nav. Co. (C. C.) 82 Fed. 775.....	613
King v. Hamilton, 4 Pet. 328, 7 L. Ed. 869.....	117	Lebanon Min. Co. v. Consolidated Co., 6 Colo. 371.....	972
King v. Inlander (C. C.) 133 Fed. 416....	95	Lee v. Hammond, 114 Wis. 550, 90 N. W. 1073.....	550, 552
King v. Mullins, 171 U. S. 404, 18 Sup. Ct. 925, 43 L. Ed. 214.....	764	Lee v. Lee, 55 Ala. 590.....	687
King v. Smith, 110 Fed. 95, 49 C. C. A. 46, 54 L. R. A. 708.....	933	Lee v. Simmons, 65 Wis. 523, 27 N. W. 174.....	137
Kinnear Mfg. Co. v. Carlisle, 82 C. C. A. 81, 152 Fed. 933.....	182	Lee v. U. S., 156 Fed. 948, 84 C. C. A. 448.....	260, 262
Kinney v. Columbia Sav. Ass'n. 191 U. S. 78, 24 Sup. Ct. 30, 48 L. Ed. 103....	769	Lee Sing Far v. U. S., 94 Fed. 834, 35 C. C. A. 327.....	330
Kipp v. Fernhold, 37 Minn. 132, 134, 33 N. W. 697.....	969	Leggett v. Standard Oil Co., 149 U. S. 287, 13 Sup. Ct. 902, 37 L. Ed. 737.....	322
Kirk v. Milwaukee Dust Collector Co. (C. C.) 26 Fed. 505.....	74	Lehnen v. Dickson, 148 U. S. 71, 13 Sup. Ct. 481, 37 L. Ed. 373.....	651
Kleibs, In re (C. C.) 128 Fed. 656.....	153	Lem Moon Sing v. U. S., 153 U. S. 538, 15 Sup. Ct. 967, 39 L. Ed. 1032.....	154
Kleinhaus v. Jones, 68 Fed. 742, 749, 15 C. C. A. 644, 651.....	627	Leschen Co. v. Broderick Co., 134 Fed. 571, 67 C. C. A. 418.....	94
Knight, In re (D. C.) 125 Fed. 35....	825	Leslie, In re (D. C.) 119 Fed. 406.....	692
Knight v. Railroad Co., 108 Pa. 250, 56 Am. Rep. 200.....	268	Leslie v. Wm. Mann Co. (C. C.) 157 Fed. 236.....	64
Knoth v. Barclay, 8 Colo. 300, 302, 6 Pac. 924.....	972	Leverick v. Meigs, 1 Cow. (N. Y.) 645, 663	105
Knowles v. Gaslight & Coke Co., 19 Wall. 58, 22 L. Ed. 70.....	283	Leverton, In re, 19 Am. Bankr. Rep. 426, 155 Fed. 925.....	590
Kohl v. U. S., 91 U. S. 367, 23 L. Ed. 449..	742	Levy v. Hamilton, 68 App. Div. 277, 74 N. Y. Supp. 159.....	143
Kokomo Fence Mach. Co. v. Kitzelman, 139 U. S. 8, 18, 19, 23 Sup. Ct. 521, 47 L. Ed. 639.....	734, 736, 742	Levy v. Stewart, 78 U. S. 244, 20 L. Ed. 86.....	576

	Page		Page
License Cases, 5 How. 632, 12 L. Ed. 256	233	McCarthy's Appeal, 68 Pa. 217.....	266
Lima Locomotive Works v. National Steel Co., 155 Fed. 77, 83 C. C. A. 593, 11 L. R. A. (N. S.) 713.....	835	McClellan v. Troendle (not reported).....	359
Lindt v. Uiglein, 116 Iowa, 48, 89 N. W. 215.....	439	McCloskey v. Pacific Coast Co. (C. C. A.) 160 Fed. 794.....	977
Linhart v. Buiff, 11 Cal. 280.....	972	McCoach v. Bamberger (C. C. A.) 161 Fed. 90.....	802
Littlefield v. Perry, 21 Wall. 205, 227, 22 L. Ed. 577.....	63, 64	McCoach v. Philadelphia Trust Co., 73 C. C. A. 610, 142 Fed. 120; 205 U. S. 539, 27 Sup. Ct. 793, 51 L. Ed. 821.....	801, 802
Liverpool S. S. Co. v. Phoenix Ins. Co., 129 U. S. 397, 445, 9 Sup. Ct. 469, 32 L. Ed. 788.....	873	McCormick Co. v. Walthers, 145 U. S. 41, 43, 10 Sup. Ct. 485, 33 L. Ed. 833.....	292
Lloyd v. Brewster, 4 Paige (N. Y.) 541, 27 Am. Dec. 88.....	204	McCourt v. Singers-Bigger, 145 Fed. 103, 112, 76 C. C. A. 73, 82.....	811
Lloyd v. Guibert, L. R. 1 Q. B. 115, 119	873	McCulloch v. Maryland, 17 U. S. 411, 4 L. Ed. 579.....	257
Loan Ass'n v. Topeka, 87 U. S. 662, 22 L. Ed. 455.....	250	McElroy v. U. S., 164 U. S. 76, 17 Sup. Ct. 31, 41 L. Ed. 355.....	895
Lockwood v. Exchange Bank, 190 U. S. 294, 23 Sup. Ct. 751, 47 L. Ed. 1061.....	527	Mack v. Drummond Tobacco Co., 48 Neb. 397, 67 N. W. 174, 53 Am. St. Rep. 691	805
Loeb v. Columbia Tp. Trustees, 179 U. S. 472, 21 Sup. Ct. 174, 45 L. Ed. 280.....	984	McKay v. Smith (C. C.) 39 Fed. 556.....	424
Loeber v. Schrader, 149 U. S. 580, 583, 13 Sup. Ct. 934, 37 L. Ed. 856.....	693	McKenzie, In re, 142 Fed. 383, 73 C. C. A. 483.....	824
Loewe v. Lawlor, 208 U. S. 274, 279, 28 Sup. Ct. 301, 52 L. Ed. 488.....	727	McKown v. Kansas & T. Coal Co. (C. C.) 105 Fed. 657.....	359
Loew Filter Co. v. German-American Filter Co. of New York, 107 Fed. 949, 47 C. C. A. 94.....	861	McLean v. Meek, 18 How. 16-18, 15 L. Ed. 277.....	822
Londoner v. Denver, 210 U. S. 373, 28 Sup. Ct. 708, 52 L. Ed. 1103.....	762	McLellan v. Crofton, 6 Greenl. (Me.) 307, 328.....	972
Lone Wolf v. Hitchcock, 187 U. S. 553, 23 Sup. Ct. 216, 47 L. Ed. 299.....	673	McLemore v. Louisiana State Bank, 91 U. S. 27, 23 L. Ed. 196.....	177
Longstreth v. Pennock, 87 U. S. 575, 22 L. Ed. 451.....	485, 486	McMahon, In re, 147 Fed. 689, 77 C. C. A. 673.....	824
Longyear v. Toolan, 209 U. S. 417, 28 Sup. Ct. 506, 52 L. Ed. 859.....	762	McMillan v. Spider Lake, etc., Co., 115 Wis. 332, 91 N. W. 979, 60 L. R. A. 589, 95 Am. St. Rep. 947.....	263
Lottery Case, 188 U. S. 321, 353, 23 Sup. Ct. 321, 47 L. Ed. 492.....	239, 249, 255	McNair v. Lot, 34 Mo. 285, 302, 84 Am. Dec. 78.....	320
Loudenback Fertilizer Co. v. Tennessee Phosphate Co., 121 Fed. 298, 58 C. C. A. 220, 61 L. R. A. 402.....	835	McNamara, In re, 2 Am. Bankr. Rep. 566	623
Loudon v. Taxing Dist., 104 U. S. 771, 774, 26 L. Ed. 923.....	541	Maddox v. Burnham, 156 U. S. 544, 546, 15 Sup. Ct. 448, 39 L. Ed. 527.....	921
Lough v. Outenbridge, 143 N. Y. 271, 38 N. E. 292, 25 L. R. A. 674, 42 Am. St. Rep. 712.....	721	Madisonville Traction Co. v. St. Bernard Min. Co. (C. C.) 130 Fed. 789; 196 U. S. 239, 25 Sup. Ct. 251, 49 L. Ed. 462	361, 737, 468
Louisville, etc., Co. v. McClish, 53 C. C. A. 60, 68, 115 Fed. 268, 276.....	176	Magoffin v. Patton, 4 Rawle (Pa.) 113.....	176
Louisville Trust Co. v. Comingor, 184 U. S. 18, 22 Sup. Ct. 293, 46 L. Ed. 413.....	416	Maguire v. Middlesex R. Co., 115 Mass. 239	176
Louisville & N. R. Co. v. Board of Public Instruction, 50 Fla. 222, 39 South. 481	765	Maiorano v. Baltimore & O. R. Co., 216 Pa. 402, 65 Atl. 1077, 116 Am. St. Rep. 778	263
Louisville & N. R. Co. v. Palmes, 109 U. S. 244, 256, 257, 3 Sup. Ct. 193, 27 L. Ed. 922.....	575, 576	Marbury v. Madison, 1 Cranch, 137, 176, 2 L. Ed. 60.....	235
Love v. Ardmore Stock Exch., 5 Ind. T. 202, 82 S. W. 721, 67 L. R. A. 617.....	186	March v. Eastern R. Co., 40 N. H. 548, 77 Am. Dec. 732.....	613
Low v. Blackford, 87 Fed. 392, 31 C. C. A. 15.....	758	Marquardt v. French (D. C.) 53 Fed. 603, 606.....	106
Luke v. Calhoun Co., 52 Ala. 115.....	264	Martin v. McDiarmid, 55 Ark. 213, 216, 17 S. W. 877.....	968
Lynch v. Burt, 132 Fed. 417, 67 C. C. A. 305.....	143	Marvel Co. v. Pearl (C. C.) 114 Fed. 946	208
McCabe v. Matthews, 155 U. S. 550, 555, 15 Sup. Ct. 190, 192, 39 L. Ed. 253.....	117, 121, 122	Mason City R. Co. v. Boynton, 204 U. S. 570, 576, 27 Sup. Ct. 321, 51 L. Ed. 629	735, 737, 745
McCann v. Chicago, M. & St. P. R. Co., 105 Fed. 480, 44 C. C. A. 566.....	793	Mason v. Hepburn, 84 O. G. 147.....	193
		Mason v. Sargent, 104 U. S. 689, 26 L. Ed. 894.....	800
		Mast, Foos & Co. v. Dempster Mill Mfg. Co., 82 Fed. 327, 27 C. C. A. 191.....	194
		Matthes v. Burt, 114 O. G. 764.....	193
		Mayer, In re (D. C.) 101 Fed. 227.....	516
		Mayor v. American Cable Railroad, 60 Fed. 1016, 9 C. C. A. 336.....	50

	Page		Page
Mechanics' Bank v. Heard, 37 Ga. 401...	492	Morgan v. U. S., 78 C. C. A. 323, 148 Fed. 189	958
Medsker v. Bonebrake, 108 U. S. 66, 72, 2 Sup. Ct. 351, 27 L. Ed. 634	603	Morrill v. Jones, 106 U. S. 466, 1 Sup. Ct. 423, 27 L. Ed. 267	271
Mellen v. Iron Works, 131 U. S. 352, 369, 9 Sup. Ct. 781, 33 L. Ed. 178	757	Morris v. Baltimore & M. R. Co., 183 Mass. 368, 68 N. E. 680	40
Mercantile Ins. Co., In re, Fed. Cas. No. 9,431	496	Morris v. Canada, 80 Fed. 739, 26 C. C. A. 128	652
Meriden Bank v. Galluadet, 120 N. Y. 298, 24 N. E. 994	547	Morrison v. Burnette, 154 Fed. 617, 622, 83 C. C. A. 391, 396	842
Messmore v. New York Shot & Lead Co., 40 N. Y. 422	985	Moss' Appeal, 35 Pa. 162	486
Metcalf v. Barker, 187 U. S. 165, 23 Sup. Ct. 67, 47 L. Ed. 122	592	Mountain Copper Co. v. U. S., 142 Fed. 625, 73 C. C. A. 621	940
Metcalf v. Watertown, 128 U. S. 586, 9 Sup. Ct. 173, 32 L. Ed. 543	744	Mowry v. Whitney, 14 Wall. 620, 20 L. Ed. 860	854
Metropolitan Nat. Bank v. Van Dyck, 27 N. Y. 416	356	Mudsill Min. Co. v. Watrous, 61 Fed. 163, 9 C. C. A. 415	142
Mexican Nat. R. Co. v. Davidson, 157 U. S. 201, 15 Sup. Ct. 563, 39 L. Ed. 672	744	Mueller v. Bruss, 8 Am. Bankr. Rep. 442, 112 Wis. 406, 88 N. W. 229	622
Mexican Ry. v. Pinkney, 149 U. S. 194, 207, 13 Sup. Ct. 859, 37 L. Ed. 699	82	Mugler v. Kansas, 123 U. S. 623, 8 Sup. Ct. 273, 31 L. Ed. 205	234
Meyers, In re (D. C.) 96 Fed. 408	692	Mulhall v. Fallon, 176 Mass. 266, 57 N. E. 386, 54 L. R. A. 934, 79 Am. St. Rep. 309	263, 265, 816
Milby v. U. S., 57 C. C. A. 21, 120 Fed. 1	956	Munday v. Vail, 34 N. J. Law, 418	816
Miller v. Cook, 135 Ill. 190, 203, 25 N. E. 756, 10 L. R. A. 292	973	Munger Vehicle Tire Co., In re (C. C. A.) 19 Am. Bankr. Rep. 785, 159 Fed. 901	494
Miller v. Eagle Co., 151 U. S. 186, 201, 14 Sup. Ct. 310, 38 L. Ed. 121	996	Murph v. McCullough, 40 Tex. Civ. App. 403, 90 S. W. 69	687
Miller v. Gilbert, 144 N. Y. 68, 73, 38 N. E. 979	469	Murphy v. Lyons, 19 Neb. 689, 28 N. W. 328	969
Miller v. Hughes, 1 A. K. Marsh. (Ky.) 181, 10 Am. Dec. 719	547	Murphy v. U. S., T. D. 28,819; T. D. 29,032, 162 Fed. 871	70
Miller v. Mfg. Co., 151 U. S. 186, 207, 208, 14 Sup. Ct. 310, 38 L. Ed. 121	993	National Bank v. Carpenter, 101 U. S. 567, 25 L. Ed. 815	321
Milwaukee Co. v. Isenring, 109 Wis. 8, 26, 85 N. W. 131, 137, 53 L. R. A. 635	185	National Bank v. Case, 99 U. S. 628, 25 L. Ed. 443	832
Mining Co. v. Field, 64 Md. 151, 20 Atl. 1039	613	National Cotton Oil Co. v. Texas, 197 U. S. 115, 129, 25 Sup. Ct. 379, 382, 49 L. Ed. 689	717, 720, 721
Minnesota Co. v. St. Paul Co., 2 Wall. 609, 633, 17 L. Ed. 886	93, 97	National Folding Box Co. v. American Paper Pail Co. (C. C.) 55 Fed. 488	49
Minnesota v. Northern Securities Co., 194 U. S. 48, 24 Sup. Ct. 598, 48 L. Ed. 870	744	National Hollow Break Beam Co. v. Interchangeable Break Beam Co., 106 Fed. 693, 707, 45 C. C. A. 544	697, 1000
Minturn v. Maynard, 17 How. 477, 15 L. Ed. 235	106	National Rubber Co. v. Boston Rubber Shoe Co. (C. C.) 41 Fed. 48	424
Missouri Pac. R. Co. v. Moseley, 57 Fed. 921, 925, 6 C. C. A. 641, 645, 43, 829,	830	National Surety Co. v. Railroad Co., 145 Fed. 34, 76 C. C. A. 19	652
Mitchell v. Cline, 84 Cal. 410, 415, 24 Pac. 164	538	Nay v. Byers, 13 Ind. 412	811
Mitchell v. Missouri Pac. R. Co., 82 Mo. 106	972	Neagle, In re, 135 U. S. 1, 10 Sup. Ct. 658, 34 L. Ed. 55	635
Mobile Co. v. Kimball, 102 U. S. 691, 26 L. Ed. 238	357	Neely v. Henkel, 180 U. S. 109, 21 Sup. Ct. 308, 45 L. Ed. 457	873
Mobile, etc., R. Co. v. Tennessee, 153 U. S. 552, 14 Sup. Ct. 968, 38 L. Ed. 793	361	Nelson v. Northern Pac. R. Co., 188 U. S. 108, 109, 116-133, 23 Sup. Ct. 302, 304, 311, 47 L. Ed. 406	915, 916, 919, 923, 925, 926
Monmouth Inv. Co. v. Means, 151 Fed. 159, 80 C. C. A. 527	612, 613	Nevada Co. v. Farnsworth, 42 C. C. A. 504, 102 Fed. 573	960
Monongahela Nav. Co. v. U. S., 148 U. S. 336, 13 Sup. Ct. 630, 37 L. Ed. 463	238, 246	Newburyport Water Co. v. Newburyport, 193 U. S. 561, 576, 24 Sup. Ct. 553, 556, 48 L. Ed. 795	606
Montague & Co. v. Lowry, 193 U. S. 38, 47, 24 Sup. Ct. 307, 310, 48 L. Ed. 608	716, 727	New England Iron Co. v. Gilbert El. R. Co., 91 N. Y. 153	103
Montana Ore Purchasing Co. v. Boston & M. C. G. & S. Min. Co., 29 C. C. A. 462, 85 Fed. 867	608	Newhall v. McCabe Hanger Mfg. Co., 125 Fed. 919, 60 C. C. A. 629	196
Moore, In re, 209 U. S. 490, 28 Sup. Ct. 585, 706, 52 L. Ed. 904	768, 769, 770		
Moore v. Robbins, 96 U. S. 530, 21 L. Ed. 758	644		
Morgan, In re (D. C.) 101 Fed. 982	692		
Morgan v. Railroad Co., 137 U. S. 193, 11 Sup. Ct. 61, 34 L. Ed. 625	758		

	Page		Page
New Haven R. Co. v. Interstate Commerce Com., 200 U. S. 361, 399, 26 Sup. Ct. 272, 280, 50 L. Ed. 515.....	256	Parker v. Black (D. C.) 16 Am. Bankr. Rep. 202, 143 Fed. 560.....	623
Newport News, etc., Co. v. Pace, 158 U. S. 36, 15 Sup. Ct. 743, 39 L. Ed. 887..	176	Parker-Washington Co. v. Kansas City, 73 Kan. 722, 85 Pac. 781.....	741
New York City v. Pine, 185 U. S. 93, 22 Sup. Ct. 592, 46 L. Ed. 820.....	941	Parker v. Winnipisogee Lake & Woolen Co., 67 U. S. 545, 552, 553, 17 L. Ed. 333	941
New York ex rel. Penn. R. Co. v. Knight, 192 U. S. 21, 24 Sup. Ct. 202, 48 L. Ed. 325.....	568	Parr v. Matthews, 50 Ark. 390, 393, 8 S. W. 22.....	968
New York Paper Bag Co. v. Union Paper Bag Co. (C. C.) 32 Fed. 783, 788.....	50	Parsons v. Robinson, 122 U. S. 112, 7 Sup. Ct. 1153, 30 L. Ed. 1122.....	758
Nickerson v. Nickerson, 127 U. S. 668, 677, 8 Sup. Ct. 1355, 1359, 32 L. Ed. 314.....	117	Partridge v. Insurance Co., 15 Wall. 573, 21 L. Ed. 229.....	979
Nippel v. Forker, 26 Colo. 74, 56 Pac. 577	500	Patillo v. Allen-West Co., 131 Fed. 680, 65 C. C. A. 508.....	90
Norris v. Ile, 152 Ill. 190, 203, 204, 38 N. E. 762, 43 Am. St. Rep. 233.....	973	Patnode v. Westenhaber, 114 Wis. 460, 90 N. W. 467.....	140
Norris v. Jackson, 9 Wall. 125, 19 L. Ed. 608.....	651	Patterson v. Kentucky, 97 U. S. 501, 506, 508, 24 L. Ed. 1115.....	234, 240
North American Exploration Co. v. Adams, 104 Fed. 404, 45 C. C. A. 185.....	665	Patterson v. Thompson (C. C.) 86 Fed. 85	677
Northern Pac. R. Co. v. Colburn, 164 U. S. 383, 387, 17 Sup. Ct. 98, 41 L. Ed. 479.....	923	Pattillo v. Allen-West Co., 65 C. C. A. 503, 131 Fed. 680.....	177
Northern Pac. R. Co. v. Freeman, 174 U. S. 379, 383, 19 Sup. Ct. 763, 43 L. Ed. 1014.....	829	Patton v. Texas & P. R. Co., 179 U. S. 658, 660, 21 Sup. Ct. 275, 45 L. Ed. 361..177.	830
Northern Pac. R. Co. v. McCormick, 94 Fed. 932, 36 C. C. A. 560.....	916	Paul v. Delaware, L. & W. R. Co. (C. C.) 130 Fed. 951; 147 Fed. 51, 77 C. C. A. 315.....	652, 480
Northern Pac. R. Co. v. Sanders, 166 U. S. 620, 17 Sup. Ct. 671, 41 L. Ed. 1139	925	Payne v. Hook, 7 Wall. 423, 19 L. Ed. 260	480
Northern Securities Case, 193 U. S. 197, 329, 331, 337, 350, 24 Sup. Ct. 436, 453, 457, 462, 48 L. Ed. 679.....	716, 717, 721, 726	Pearcy v. Stranahan, 205 U. S. 257, 27 Sup. Ct. 545, 51 L. Ed. 793.....	873
Northwestern Tel. Exch. Co. v. Minneapolis, 81 Minn. 140, 83 N. W. 527, 86 N. W. 69, 53 L. R. A. 175.....	578	Pearsall v. Smith, 149 U. S. 235, 236, 13 Sup. Ct. 833, 37 L. Ed. 713.....	841
Northwestern Tel. Exch. Co. v. St. Charles (C. C.) 154 Fed. 386.....	577	Pearson v. Williams, 202 U. S. 231, 26 Sup. Ct. 608, 50 L. Ed. 1029.....	154
O'Brien v. St. Paul City R. Co., 98 Minn. 205, 108 N. W. 805.....	43	Pease v. Peck, 18 How. 595, 598, 15 L. Ed. 518.....	576
Off v. Hakes, 15 Am. Bankr. Rep. 697, 142 Fed. 364, 73 C. C. A. 464.....	623	Peck v. Elliott, 79 Fed. 10, 24 C. C. A. 425, 38 L. R. A. 616.....	98
Ohio Life Ins. & Tr. Co. v. Debolt, 57 U. S. 416, 432, 433, 14 L. Ed. 997.....	575	Peik v. Railroad Co., 94 U. S. 164, 24 L. Ed. 97.....	888
Oregon & C. R. Co. v. U. S., 189 U. S. 103, 23 Sup. Ct. 615, 47 L. Ed. 726.. 915.	925	Pender v. Brown, 120 Fed. 496, 56 C. C. A. 646.....	839
Osborne v. Bank, 9 Wheat. 739, 6 L. Ed. 204.....	18	Penn. v. Lord Baltimore, 1 Vesey, Sr. 444..	871
Oskamp v. Lewis (C. C.) 103 Fed. 906..	764	Pennoyer v. McConnaughy, 140 U. S. 1, 11 Sup. Ct. 699, 35 L. Ed. 363.....	18
Pacific R. Co. v. Missouri Pac. R. Co., 111 U. S. 505, 4 Sup. Ct. 583, 28 L. Ed. 498.....	93	Pennoyer v. Neff, 95 U. S. 714-730, 24 L. Ed. 565-571.....	283
Packard v. Moss, 68 Cal. 126, 8 Pac. 812	439	Penn. R. Co. v. Knight, 192 U. S. 21, 27, 24 Sup. Ct. 202, 48 L. Ed. 325.....	569
Packer v. Bird, 137 U. S. 661, 11 Sup. Ct. 210, 34 L. Ed. 819.....	607	Pennsylvania v. Wheeling, etc., Co., 18 How. 421, 15 L. Ed. 435.....	357
Paine v. Trask, 56 Fed. 233, 5 C. C. A. 497.....	50	Pensacola Tel. Co. v. Western Union Tel. Co., 96 U. S. 1, 24 L. Ed. 708.....	357
Palatka Water Works v. Palatka (C. C.) 127 Fed. 101.....	893	People v. Calder, 30 Mich. 85.....	553
Paper Bag Patent Case, 210 U. S. 405, 422, 28 Sup. Ct. 748, 52 L. Ed. 1122..	59	People v. North River Sugar Refining Co., 54 Hun, 377, 3 N. Y. Supp. 401, 2 L. R. A. 33.....	721
Pardee v. Kanady, 100 N. Y. 101, 2 N. E. 885.....	103	Peoria Co. v. Lyons, 153 Ill. 427, 38 N. E. 661.....	805
		Pfaffinger, In re (D. C.) 154 Fed. 523.....	135
		Phalen v. Virginia, 8 How. 163, 168, 12 L. Ed. 1030.....	239
		Phelps v. Smith, 16 W. Va. 522.....	973
		Philadelphia Trust, etc., Co. v. McCoach, 135 Fed. 866.....	801
		Philadelphia & R. R. Co. v. Derby, 14 How. 468-486, 14 L. Ed. 502.....	414
		Phillips v. Louisville & N. R. Co., 153 Fed. 795.....	1023
		Phillips v. Negley, 117 U. S. 665, 6 Sup. Ct. 901, 29 L. Ed. 1013.....	325

	Page		Page
Philpott v. Missouri Pac. R. Co., 85 Mo. 164, 167.....	263, 269	Railroad Co. v. Minnesota, 134 U. S. 418, 10 Sup. Ct. 462, 702, 33 L. Ed. 970.....	887, 888
Pirie v. Chicago Title & Trust Co., 182 U. S. 438, 21 Sup. Ct. 906, 45 L. Ed. 1171.....	1011, 1012	Railroad Co. v. Railroad Co., 67 Kan. 569, 70 Pac. 939, 73 Pac. 899.....	743
Pirtle v. Penn, 3 Dana (Ky.) 247, 28 Am. Dec. 70.....	547	Railroad Co. v. Smith, 128 U. S. 174, 9 Sup. Ct. 47, 32 L. Ed. 377.....	887
Pittsburgh, etc., R. Co. v. Naylor, 73 Ohio St. 115, 76 N. E. 505, 3 L. R. A. (N. S.) 473, 112 Am. St. Rep. 701.....	266, 268	Railroad Co. v. Swasey, 23 Wall. 405, 23 L. Ed. 136.....	758
Pittsburgh Plate Glass Co. v. Edwards, 17 Am. Bankr. Rep. 447, 148 Fed. 377, 78 C. C. A. 191.....	454	Randolph v. Scruggs, 190 U. S. 533, 537, 538, 23 Sup. Ct. 710, 47 L. Ed. 1165.....	556, 826, 969
Platt v. Johnson, 168 Pa. 47, 31 Atl. 935, 47 Am. St. Rep. 877.....	487	Rankin v. Miller, 43 Iowa. 11, 21.....	969
Platt v. Union Pac. R. Co., 99 U. S. 63, 64, 25 L. Ed. 424.....	360	Reagan v. Trust Co., 154 U. S. 362, 14 Sup. Ct. 1047, 38 L. Ed. 1014.....	887, 888
Pleasants v. Fant, 22 Wall. 116, 122, 22 L. Ed. 780.....	535	Rea v. Missouri, 17 Wall. 532-543, 21 L. Ed. 707.....	668
Plummer v. Northern Pac. R. Co. (C. C.) 152 Fed. 206.....	698	Rearick v. Pennsylvania, 203 U. S. 507, 27 Sup. Ct. 159, 51 L. Ed. 295.....	714
Plymouth Cordage Co., In re, 135 Fed. 1000, 68 C. C. A. 434.....	972	Redd v. Brun, 157 Fed. 190, 84 C. C. A. 638.....	321
Pocahontas Coke Co. v. Powhatan Coal, etc. Co., 60 W. Va. 508, 56 S. E. 264, 10 L. R. A. (N. S.) 268, 116 Am. St. Rep. 901.....	721	Redfield v. Oakland C. S. R. Co., 110 Cal. 277, 42 Pac. 822, 1063.....	310
Pocahontas Coke Co. v. Rukas, 104 Va. 278, 51 S. E. 449.....	264	Reed Mfg. Co. v. Smith & Winchester Co., 107 Fed. 719, 46 C. C. A. 601.....	196
Pollock v. Jones, 10 Am. Bankr. Rep. 616, 622, 124 Fed. 163, 61 C. C. A. 555.....	455	Regan Vapor Engine Co. v. Pacific Gas Engine Co., 49 Fed. 68, 1 C. C. A. 169.....	50
Pond v. New York Exch. Bank (D. C.) 10 Am. Bankr. Rep. 343, 124 Fed. 992.....	623	Reichenbach v. Ruddach, 127 Pa. 564, 595, 18 Atl. 432.....	669
Pontiac Knit Boot Co. v. Merino Shoe Co. (C. C.) 31 Fed. 286.....	64	Reid v. Colorado, 187 U. S. 137, 23 Sup. Ct. 92, 47 L. Ed. 108.....	241
Portarlington v. Selby, 3 Mylne & K. 104, 106.....	871	Removal Cases, 100 U. S. 457-472, 25 L. Ed. 593.....	769
Postal Tel. Co. v. Baltimore, 79 Md. 502, 513, 29 Atl. 819, 24 L. R. A. 161, 156 U. S. 210, 15 Sup. Ct. 356, 39 L. Ed. 399.....	570, 602, 603	Renlund v. Commodore Min. Co., 89 Minn. 41, 47, 93 N. W. 1057, 1059, 99 Am. St. Rep. 534.....	264, 265
Post v. Supervisors, 105 U. S. 667, 26 L. Ed. 1204.....	184	Republican Mountain Silver Mines v. Brown, 58 Fed. 644, 7 C. C. A. 412, 24 L. R. A. 776.....	613
Price & Hart v. T. J. Ellis Co. (C. C.) 129 Fed. 482.....	359, 687	Rex v. Wheeler, 2 B. & A. 247.....	68
Probate Judge v. Mathes, 60 N. H. 433.....	687	Reynolds v. Stockton, 140 U. S. 254, 261, 266, 268, 11 Sup. Ct. 773, 35 L. Ed. 464.....	816
Pueblo Bldg. Co. v. Klein, 5 Colo. App. 348, 38 Pac. 608.....	176	Rice, In re (D. C.) 164 Fed. 509.....	514
Pursley v. Hayes, 22 Iowa, 11, 25, 92 Am. Dec. 350.....	969	Rice v. Standard Oil Co. (C. C.) 134 Fed. 464, 470.....	903
Puth v. Zimbleman, 99 Iowa, 641, 68 N. W. 895.....	552	Richardson v. Bosselman (C. C.) 164 Fed. 781.....	783
Pyle v. Clark, 79 Fed. 744, 25 C. C. A. 190.....	829	Richardson v. Buhl, 77 Mich. 658, 43 N. W. 1102, 6 L. R. A. 457.....	721
Quist v. Ostrom, 108 O. G. 2147.....	193	Richman v. Consolidated Gas Co., 114 App. Div. 216, 224, 100 N. Y. Supp. 81, 83.....	889, 890, 891
Quock Ting, 140 U. S. 417, 11 Sup. Ct. 733, 851, 35 L. Ed. 501.....	139, 140, 330	Richmond v. Irons, 121 U. S. 27, 7 Sup. Ct. 788, 30 L. Ed. 864.....	90
Railroad Co. v. Colwell, 39 Pa. 339, 80 Am. Dec. 526.....	253	Richmond v. Southern Bell Tel. Co., 174 U. S. 761, 19 Sup. Ct. 778, 43 L. Ed. 1162.....	566, 569, 570, 573, 574
Railroad Co. v. Du Bois, 12 Wall. 47, 63, 20 L. Ed. 265.....	694	Richter v. Jerome, 123 U. S. 233, 246, 8 Sup. Ct. 106, 31 L. Ed. 132.....	756
Railroad Co. v. Gill, 156 U. S. 649, 15 Sup. Ct. 484, 39 L. Ed. 567.....	888	Rider v. Syracuse Rapid Transit Co., 171 N. Y. 139, 63 N. E. 836, 58 L. R. A. 125.....	43
Railroad Co. v. Horst, 93 U. S. 291, 300, 23 L. Ed. 898.....	81	Ridgeway v. Huldaj, 59 Mo. 444.....	320
Railroad Co. v. Houston, 95 U. S. 697, 702, 24 L. Ed. 542.....	829, 830	Ridgway v. Wharton, 6 H. L. Cas. 238.....	950
Railroad Co. v. Koontz, 104 U. S. 5-14, 15, 26 L. Ed. 643.....	769	Riley v. Garfield Tp., 58 Kan. 299, 49 Pac. 85.....	741
		Rio Grande Sampling Co. v. Catlin, 40 Colo. 450, 94 Pac. 323.....	183
		Risdom Locomotive Works v. Medart, 158 U. S. 68, 15 Sup. Ct. 745, 39 L. Ed. 899.....	853

	Page
Robbins v. Shelby Taxing Dist., 120 U. S. 489, 497, 7 Sup. Ct. 592, 596, 30 L. Ed. 694.....	713, 714
Roberts, In re (D. C.) 24 Fed. 132.....	636
Roberts v. Great Northern R. Co. (C. C.) 161 Fed. 239.....	263
Roberts v. Johnson, 18 Am. Bankr. Rep. 132, 151 Fed. 567, 81 C. C. A. 47.....	128
Roberts Mfg. Co. v. Schlick, 62 Minn. 332, 64 N. W. 826, 10 Cyc. 269.....	988
Robertson v. Hay, 91 Pa. 242.....	299
Robinson, Ex parte, 86 U. S. 512, 22 L. Ed. 208.....	74
Robinson v. Denver City Tramway Co. (C. C. A.) 164 Fed. 174.....	419
Rochester & Charlotte Co. v. Paviour, 164 N. Y. 281, 58 N. E. 114, 52 L. R. A. 790	159
Rockett, Ex parte, 15 Nat. Bankr. Rep. 95, Fed. Cas. No. 11,977.....	313
Rodgers, In re, 11 Am. Bankr. Rep. 79, 125 Fed. 169, 60 C. C. A. 567.....	623
Rodgers v. U. S., 152 Fed. 346, 81 C. C. A. 454.....	154
Rodriguez v. U. S., 198 U. S. 156, 165, 25 Sup. Ct. 617, 49 L. Ed. 994.....	176
Roehm v. Horst, 178 U. S. 1, 20 Sup. Ct. 780, 44 L. Ed. 953.....	150
Roganville Lumber Co. v. Gulf, B. & K. G. R. Co., 36 Tex. Civ. App. 563, 82 S. W. 816.....	414
Rogers v. Brown, 61 Mo. 187.....	320
Romano v. Capital City B. & P. Co., 125 Iowa, 591, 592, 593, 101 N. W. 437, 438, 68 L. R. A. 132, 106 Am. St. Rep. 323.....	264, 268
Roosa v. Harrington, 171 N. Y. 341, 348-351, 64 N. E. 1.....	469
Roosevelt, Matter of, 143 N. Y. 120, 38 N. E. 281, 25 L. R. A. 695.....	165
Rosse v. Rust, 4 Johns. Ch. (N. Y.) 300.....	903
Rourke v. Colliery Co., 2 C. P. Div. 205.....	790
Rouse, Hazrad & Co., In re, 91 Fed. 96, 98, 33 C. C. A. 356.....	312, 314
Royall, Ex parte, 117 U. S. 241, 6 Sup. Ct. 734, 29 L. Ed. 968.....	636
Rubecane v. McKee, 6 Del. Ch. 40, 6 Atl. 639, 641.....	468
Runkle v. Burnham, 153 U. S. 216, 14 Sup. Ct. 837, 38 L. Ed. 694.....	983
Rush v. Lake, 10 Am. Bankr. Rep. 455, 122 Fed. 561, 58 C. C. A. 447.....	512
St. Anthony Falls, etc., Co. v. St. Paul Water Com'rs, 168 U. S. 349, 359, 18 Sup. Ct. 157, 42 L. Ed. 497.....	607
St. Louis v. Gleason, 15 Mo. App. 25, 29.....	973
St. Louis v. Rutz, 138 U. S. 226, 11 Sup. Ct. 337, 34 L. Ed. 941.....	651
St. Louis v. Western Union Tel. Co. (C. C.) 63 Fed. 68; 148 U. S. 92, 13 Sup. Ct. 485, 37 L. Ed. 380; 149 U. S. 465, 13 Sup. Ct. 990, 37 L. Ed. 810, 166 U. S. 388, 17 Sup. Ct. 608, 41 L. Ed. 1044.....	570, 571, 602, 603, 651, 652
St. Louis St. Flushing Co. v. American St. Flushing Co., 156 Fed. 574, 84 C. C. A. 340.....	993
St. Louis & S. F. R. Co. v. Gill, 156 U. S. 649, 15 Sup. Ct. 484, 39 L. Ed. 567.....	644, 888

	Page
St. Louis & S. F. R. Co. v. Schumacher, 152 U. S. 77, 81, 14 Sup. Ct. 479, 38 L. Ed. 361.....	43
Salkey, In re, 6 Biss. Fed. Cas. No. 12,254	73
Salla v. U. S., 104 Fed. 544, 44 C. C. A. 26	78
Saltman v. Boston Elevated R. Co., 187 Mass. 243, 72 N. E. 950.....	43
Saltonstall v. Birtwell, 150 U. S. 417, 14 Sup. Ct. 169, 37 L. Ed. 1123.....	984
San Antonio Traction Co. v. Altgelt, 200 U. S. 304, 26 Sup. Ct. 261, 50 L. Ed. 491	577
Sanborn v. Perry, 86 Wis. 361, 56 N. W. 337.....	822
Sanders Case, 166 U. S. 620, 17 Sup. Ct. 671, 41 L. Ed. 1139.....	926
Sanders v. Pottlitzer Bros. Fruit Co., 144 N. Y. 209, 39 N. E. 75, 29 L. R. A. 431, 43 Am. St. Rep. 757.....	951
San Diego Land & Town Co. v. Jasper (C. C.) 110 Fed. 702, 712; 189 U. S. 439, 23 Sup. Ct. 571, 47 L. Ed. 892.....	877, 888, 891
San Diego Land & Town Co. v. National City (C. C.) 74 Fed. 79; 174 U. S. 739, 750, 19 Sup. Ct. 804, 43 L. Ed. 1154.....	888
San Francisco v. Western Union Tel. Co., 96 Cal. 151, 31 Pac. 10, 17 L. R. A. 301	571
San Joaquin, etc., Canal Co. v. Stanislaus County (C. C.) 163 Fed. 567.....	889
Sargent v. Blake (C. C. A.) 20 Am. Bankr. Rep. 116, 123, 124, 160 Fed. 57, 63, 64.....	511
Sarrizin v. W. R. Irby Cigar & Tobacco Co., 93 Fed. 624, 35 C. C. A. 496, 46 L. R. A. 541.....	35
Savings Bank v. U. S., 19 Wall. 227, 22 L. Ed. 80.....	799
Saxlehner v. Eisner Co., 179 U. S. 19-31, 21 Sup. Ct. 7, 45 L. Ed. 60.....	1003
Saxlehner v. Wagner (C. C. A.) 157 Fed. 745.....	214
Scanlan, In re (D. C.) 97 Fed. 26.....	516
Scannell v. American Soda Fountain Co., 161 Mo. 606, 61 S. W. 889.....	320
Schaezlein v. Cabaniss, 135 Cal. 466, 67 Pac. 755, 56 L. R. A. 733, 87 Am. St. Rep. 122.....	274
Scheffer v. Railroad Co., 105 U. S. 249, 26 L. Ed. 1070.....	407
Schell v. Fauche, 138 U. S. 562, 11 Sup. Ct. 376, 34 L. Ed. 1040.....	101
Schenck v. Diamond Match Co., 73 Fed. 22, 19 C. C. A. 352.....	687
Schermerhorn, In re, 145 Fed. 341, 76 C. C. A. 215.....	826
Scheuer v. Book, etc., Co., 7 Am. Bankr. Rep. 390, 112 Fed. 407, 50 C. C. A. 312.....	493
Schlemmer v. Buffalo, etc., R. Co., 205 U. S. 1, 27 Sup. Ct. 407, 51 L. Ed. 681.....	859
Schlereth v. Schlereth, 173 N. Y. 444, 449, 66 N. E. 130, 93 Am. St. Rep. 616.....	469
Schofield v. Chicago, M. & St. P. R. Co., 114 U. S. 615, 5 Sup. Ct. 1125, 29 L. Ed. 224.....	43, 829, 830
School Dist. v. Chapman, 82 C. C. A. 35, 152 Fed. 887.....	183
School Dist. v. De Weese (C. C.) 100 Fed. 705.....	79
Schriefer v. Wood, 5 Blatchf. 215, Fed. Cas. No. 12,481.....	206
Schuyler Nat. Bank v. Bollong, 28 Neb. 684, 692, 45 N. W. 164.....	973

	Page		Page
Scott v. Donald, 163 U. S. 58, 17 Sup. Ct. 265, 41 L. Ed. 632.....	549	Simmons v. Saul, 138 U. S. 439, 11 Sup. Ct. 369, 34 L. Ed. 1054.....	283
Scotten v. Sutter, 37 Mich. 526.....	811	Sinking Fund Cases, 99 U. S. 700, 718, 25 L. Ed. 496.....	235
Searcy Co. v. Thompson, 66 Fed. 92, 6 C. C. A. 674.....	652	Skiddy v. Atlantic, M. & O. R. Co., Fed. Cas. No. 12,922.....	756, 757
Searl v. School Dist. No. 2, 124 U. S. 197, 199, 8 Sup. Ct. 460, 461, 31 L. Ed. 415.....	743	Smelting Co. v. Kemp, 104 U. S. 636, 651, 26 L. Ed. 875.....	538
Sears v. Hotchkiss, 25 Conn. 171, 65 Am. Dec. 557.....	613	Smith, In re, 143 Cal. 368, 77 Pac. 180.....	237
Security Trust Co. v. Lexington, 203 U. S. 323, 27 Sup. Ct. 87, 51 L. Ed. 204.....	762	Smith v. Adams, 130 U. S. 167, 9 Sup. Ct. 566, 32 L. Ed. 895.....	744
Seeberger v. Castro, 153 U. S. 32, 14 Sup. Ct. 766, 38 L. Ed. 624.....	68	Smith v. Edwards, 88 N. Y. 103.....	469
Seeley v. Taylor, 17 Colo. 70, 79, 28 Pac. 461, 723.....	971	Smith v. French, 141 N. C. 1, 53 S. E. 435	979
Seibert, Appeal of, 19 Pa. 49, 56.....	468	Smith v. Kipp, 49 Minn. 119, 125, 51 N. W. 656.....	969
Seitz v. Brewers' Refrigerating Co., 141 U. S. 517, 12 Sup. Ct. 48, 35 L. Ed. 837.....	600	Smith v. London & S. W. R. Co., L. R., 6 C. P. 14.....	795
Settlemier v. Sullivan, 97 U. S. 444, 448, 24 L. Ed. 1110.....	968	Smith v. Reeves, 178 U. S. 426, 20 Sup. Ct. 919, 44 L. Ed. 1140.....	736
Seymour v. Delancey, 6 Johns. Ch. (N. Y.) 222.....	115	Smith v. St. Louis & S. F. R. Co., 85 Mo. 418, 55 Am. Rep. 380.....	791
Seymour v. Delancy, 3 Cow. (N. Y.) 445, 15 Am. Dec. 270.....	115	Smith v. Strother, 68 Cal. 194, 8 Pac. 852	888
Seymour v. Freer, 5 Wall. 822, 18 L. Ed. 564.....	687	Smith v. Stormstedt, 16 How. 303, 14 L. Ed. 942.....	886
Seymour v. Osborne, 11 Wall. 516, 20 L. Ed. 33.....	1000	Smith v. Townsend, 148 U. S. 495, 13 Sup. Ct. 634, 37 L. Ed. 533.....	361
Shand v. Du Buisson, L. R. 18 Eq. 283.....	187	Smith v. Vanderburg, 46 Ill. 34.....	375
Shanley v. Herold, 141 Fed. 423.....	801	Smithers v. Smith, 204 U. S. 632, 642, 27 Sup. Ct. 297, 51 L. Ed. 671.....	988
Sharpless v. Philadelphia, 21 Pa. 164, 59 Am. Dec. 759.....	251	Smyth v. Ames, 169 U. S. 466, 18 Sup. Ct. 418, 42 L. Ed. 819.....	888
Shaw v. Quincy Min. Co., 145 U. S. 444, 12 Sup. Ct. 935, 36 L. Ed. 768.....	768	Snap, The (D. C.) 24 Fed. 510.....	317
Shaw v. Railroad, 100 U. S. 605, 25 L. Ed. 757.....	756	Society for Establishing Manufactures v. Morris Canal Co., 1 N. J. Eq. 186, 21 Am. Dec. 41.....	613
Shawnee Compress Co. v. Anderson, 209 U. S. 423, 434, 28 Sup. Ct. 572, 575, 52 L. Ed. 865, 869.....	727	Somerby v. Buntin, 118 Mass. 279, 19 Am. Rep. 459.....	63
Sheffield & B. Coal, Iron & R. Co. v. Gordon, 151 U. S. 285, 293, 14 Sup. Ct. 343, 38 L. Ed. 164.....	811	Sommermeier v. Schwartz, 89 Wis. 66, 71, 61 N. W. 311.....	143
Shelby Co. v. Union, etc., Bank, 161 U. S. 149, 151, 16 Sup. Ct. 558, 40 L. Ed. 650.....	575	South Carolina v. U. S., 199 U. S. 437, 26 Sup. Ct. 110, 50 L. Ed. 261.....	22
Sheldon v. Parker, 11 Am. Bankr. Rep. 152, 66 Neb. 610, 92 N. W. 923, 95 N. W. 1015.....	623	South Carolina v. Wesley, 155 U. S. 542, 15 Sup. Ct. 230, 39 L. Ed. 254.....	19
Sheldon's Lessee v. Newton, 3 Ohio St. 494, 503.....	819	Southern Lumber Co. v. Ward, 208 U. S. 126, 28 Sup. Ct. 239, 52 L. Ed. 420.....	727
Shepard v. Adams, 168 U. S. 618, 18 Sup. Ct. 216, 42 L. Ed. 604.....	83	Southern Pac. Co. v. Denton, 146 U. S. 202, 13 Sup. Ct. 44, 36 L. Ed. 942.....	292
Sherlock v. Alling, 93 U. S. 99, 23 L. Ed. 819.....	353	Southern Pac. R. Co. v. Lopez, 3 Land Dec. Dep. Int. 130, 131.....	926
Sherwood v. Newport News Co. (C. C.) 55 Fed. 1.....	768	Southern Pac. Co. v. Pool, 160 U. S. 438, 440, 16 Sup. Ct. 338, 40 L. Ed. 485.....	117, 830
Shields v. Ohio, 95 U. S. 319, 24 L. Ed. 357.....	577	South Ottawa v. Perkins, 94 U. S. 260, 267-269, 277, 24 L. Ed. 154.....	184
Shipman v. Rollins, 98 N. Y. 311, 327.....	469	Southwestern Land Co. v. Hickory Jackson Ditch Co., 18 Colo. 489, 33 Pac. 275.....	972, 973
Shively v. Bowlby, 152 U. S. 1, 58, 14 Sup. Ct. 548, 570, 38 L. Ed. 331.....	607, 608, 976	Spaven v. Lake Shore & M. S. R. Co., 130 Mich. 579, 90 N. W. 325.....	40
Shoshone Min. Co. v. Rutter, 177 U. S. 505, 20 Sup. Ct. 726, 44 L. Ed. 864.....	607	Spokane Truck & Dray Co. v. Hoefer, 2 Wash. St. 45, 25 Pac. 1072, 11 L. R. A. 689, 26 Am. St. Rep. 842.....	549
Shreve v. Chessman, 69 Fed. 785, 16 C. C. A. 413.....	534	Spring v. Eve, 2 Mod. 240.....	184
Sidway v. Marshall, 83 Ill. 438.....	972	Spring Valley Co. v. San Francisco (C. C. A.) 165 Fed. —.....	889
Sidway v. Missouri Land & Live Stock Co. (C. C.) 101 Fed. 481.....	613	Spring Val. Water Works v. San Francisco, 82 Cal. 286, 22 Pac. 910, 1046, 6 L. R. A. 756, 16 Am. St. Rep. 116; (C. C.) 124 Fed. 574.....	888, 889
Siegert v. Gondolfi, 149 Fed. 100, 79 C. C. A. 142.....	30	Spring Val. Water Works v. Schottler, 110 U. S. 347, 354, 4 Sup. Ct. 48, 28 L. Ed. 173.....	577, 888

	Page		Page
Stacy v. Thrasher, 6 How. 44, 58, 60, 12 L. Ed. 337.....	822	Sunderland Bros. v. Chicago, R. I. & P. R. Co. (C. C.) 158 Fed. 877.....	292
Stalker v. Pullman Car Co. (C. C.) 81 Fed. 889.....	768	Sundheim v. Ridge Ave. Bank (C. C. A.) 16 Am. Bankr. Rep. 863, 145 Fed. 798..	125
Standard Button Fastening Co. v. Ellis, 159 Mass. 448, 34 N. E. 682.....	424	Sun Printing & Publishing Ass'n v. Moore, 183 U. S. 642, 672, 22 Sup. Ct. 240, 252, 46 L. Ed. 366.....	306, 307, 597
Standard Castor & Wheel Co. v. Castor Socket Co., 113 Fed. 162, 51 C. C. A. 109	996	Suydam v. Williamson, 20 How. 427, 433, 15 L. Ed. 978.....	323, 324
Standard Elevator Co. v. Crane, 56 Fed. 718, 6 C. C. A. 100.....	196	Swaisland v. Dearsley, 29 Beavan, 433..	111
Standard Elevator Co. v. Crane Elevator Co., 76 Fed. 767, 22 C. C. A. 549.....	49	Swasey v. North Carolina R. Co., 23 Fed. Cas. 518.....	18
Standley v. Roberts, 59 Fed. 836, 839, 8 C. C. A. 305, 308.....	842	Sweringen v. St. Louis, 185 U. S. 38, 22 Sup. Ct. 569, 46 L. Ed. 795.....	607
Stanislaus Co. v. San Joaquin, K. R. C. & I. Co., 192 U. S. 201, 24 Sup. Ct. 241, 48 L. Ed. 406.....	577	Swift v. U. S., 196 U. S. 375, 397, 399, 25 Sup. Ct. 276, 279, 280, 49 L. Ed. 518	714, 716, 721
Stanley v. Supervisors, 121 U. S. 547, 7 Sup. Ct. 1234, 30 L. Ed. 1000.....	983	Swift & Co. v. Johnson, 71 C. C. A. 619, 626, 138 Fed. 867, 874, 1 L. R. A. (N. S.) 1161.....	177
Stark v. Starr, 73 U. S. 402, 419, 18 L. Ed. 925.....	64	Swift & Co. v. U. S., 196 U. S. 375, 25 Sup. Ct. 276, 49 L. Ed. 518.....	727
State v. Downs, 60 Kan. 788, 57 Pac. 962	741	Swihart v. Harless, 93 Wis. 211, 215, 67 N. W. 413.....	64
State v. Gooch, 97 N. C. 186, 1 S. E. 653, 2 Am. St. Rep. 284.....	687	Szymanski v. Blumenthal (Del.) 3 Penne-will, 558, 52 Atl. 347.....	264, 265
State v. Moberly, 121 Mo. 604, 26 S. W. 364.....	158		
State v. Wagner, 61 Maine, 178.....	184	Talcott v. Pine Grove, Fed. Cas. No. 13-735.....	576
State v. Western Union Tel. Co., 75 Kan. 609, 90 Pac. 299.....	568	Talmadge v. Seaman, 85 Hun, 242, 32 N. Y. Supp. 906, 908.....	468
State Railroad Cases, 92 U. S. 575, 23 L. Ed. 663.....	764	Tamplin v. James, 15 L. R. Chancery Div. 215.....	111
Stephens v. Cherokee Nation, 174 U. S. 488, 19 Sup. Ct. 722, 43 L. Ed. 1041.....	673	Tanas v. Municipal G. Co., 88 App. Div. 251, 84 N. Y. Supp. 1053.....	264
Stevens v. Nave-McCord Merc. Co., 150 Fed. 71, 73, 80 C. C. A. 25, 27.....	842	Tarpey v. Madsen, 178 U. S. 215, 219, 222, 227, 20 Sup. Ct. 849, 853, 44 L. Ed. 1042.....	922, 923, 925
Stewart v. Stone, 127 N. Y. 502, 28 N. E. 595, 14 L. R. A. 215.....	985	Taylor v. Barclay, 2 Sim. 213.....	185
Stewart v. Wyoming Ranch Co., 128 U. S. 383, 390, 9 Sup. Ct. 101, 32 L. Ed. 439.....	176	Taylor v. Carryl, 61 U. S. 583, 5 L. Ed. 1028.....	771
Stickney v. Interstate Commerce Com., 164 Fed. 638.....	650	Taylor v. Taintor, 83 U. S. 366, 21 L. Ed. 287.....	635, 636
Stockwell v. U. S., 3 Cliff. 284, Fed. Cas. No. 13,466.....	206	Taylor v. U. S., 207 U. S. 120, 28 Sup. Ct. 53, 52 L. Ed. 130.....	656
Stoher v. St. Louis, etc., R. Co., 91 Mo. 509, 4 S. W. 389.....	309	Tebo, In re (C. C.) 101 Fed. 419.....	653
Stone v. Mississippi, 101 U. S. 814, 25 L. Ed. 1079.....	239	Telephone Cases, 126 U. S. 1, 8 Sup. Ct. 778, 31 L. Ed. 863.....	854
Stone v. Railroad Co., 116 U. S. 353, 6 Sup. Ct. 349, 29 L. Ed. 651.....	887	Tennessee v. Union & Planters' Bank, 152 U. S. 454, 14 Sup. Ct. 654, 38 L. Ed. 511.....	744
Stone v. U. S., 164 U. S. 380, 17 Sup. Ct. 71, 41 L. Ed. 477.....	984	Texas Pac. Ry. v. Cox, 145 U. S. 593, 12 Sup. Ct. 905, 36 L. Ed. 829.....	90
Storck Lumber Co., In re (D. C.) 8 Am. Bankr. Rep. 86, 114 Fed. 360.....	493	Texas & P. R. Co. v. Interstate Commerce Com., 162 U. S. 197, 16 Sup. Ct. 666, 40 L. Ed. 940.....	382
Stout v. Rigney, 107 Fed. 545, 46 C. C. A. 459.....	320	Thomas Purcell, Jr., The, 92 Fed. 406, 34 C. C. A. 419.....	317
Stratton v. Essex Co. Park Com. (C. C.) 145 Fed. 436.....	902	Thomas & Taggart v. U. S., 156 Fed. 897, 84 C. C. A. 477.....	78
Streep v. U. S., 160 U. S. 128, 132, 16 Sup. Ct. 244, 246, 40 L. Ed. 365.....	956	Thompson v. Fairbanks, 196 U. S. 516, 25 Sup. Ct. 306, 49 L. Ed. 574, 13 Am. Bankr. Rep. 437.....	486
Streeter v. Sanitary Dist. of Chicago, 133 Fed. 125, 66 C. C. A. 190.....	652	Thompson v. Whitman, 18 Wall. 457, 21 L. Ed. 897.....	283
Stuart v. Adams, 89 Cal. 367, 26 Pac. 970.....	375	Thomson v. Weston, 99 O. G. 864.....	193
Sturr v. Beck, 133 U. S. 541, 547, 10 Sup. Ct. 350, 352, 33 L. Ed. 761.....	926	Thornton v. Schreiber, 124 U. S. 613, 621, 8 Sup. Ct. 618, 622, 31 L. Ed. 577.....	782
Sullivan v. Tioga R. Co., 112 N. Y. 643, 20 N. E. 569, 8 Am. St. Rep. 793.....	414	Tibbs v. Allen, 29 Ill. 535, 548.....	842
Summers v. Abbott, 58 C. C. A. 352, 122 Fed. 36.....	556		

	Page		Page
Tide-Water Oil Co. v. U. S., 171 U. S. 210, 18 Sup. Ct. 837, 43 L. Ed. 139...	207	U. S. v. Bethlehem Steel Co., 205 U. S. 105, 118, 27 Sup. Ct. 450, 455, 51 L. Ed. 731.....	307, 597
Tiffany v. Condensed Milk Co. (D. C.) 15 Am. Bankr. Rep. 417, 141 Fed. 444...	494	U. S. v. Booth, 62 U. S. 506, 16 L. Ed. 169.....	635
Tilghman v. Eidman (C. C.) 131 Fed. 651	801	U. S. v. Breen (C. C.) 40 Fed. 402.....	273
Tilghman v. Proctor, 125 U. S. 136, 148, 8 Sup. Ct. 894, 31 L. Ed. 664.....	812	U. S. v. Browne (C. C.) 126 Fed. 766...	586
Tilley v. Hudson River R. Co., 29 N. Y. 252, 86 Am. Dec. 297.....	309, 310	U. S. v. Cargo of Sugar, 3 Sawy. 46, Fed. Cas. No. 14,722.....	582
Tilton v. Cofield, 93 U. S. 163, 167, 23 L. Ed. 858.....	974	U. S. v. Central of Georgia R. Co. (D. C.) 157 Fed. 895.....	403
Tindal v. Wesley, 167 U. S. 204, 17 Sup. Ct. 770, 42 L. Ed. 137.....	19	U. S. v. Chesapeake, etc., Fuel Co. (C. C.) 105 Fed. 104.....	721
Toledo R. Co. v. Continental Trust Co., 95 Fed. 497, 36 C. C. A. 155.....	758	U. S. v. Clark (D. C.) 125 Fed. 92.....	896
Toledo v. Western Union Tel. Co., 107 Fed. 10, 46 C. C. A. 111, 52 L. R. A. 730.....	568, 569, 570	U. S. v. Cruikshank, 92 U. S. 558, 23 L. Ed. 588.....	774
Toulinson v. Bank of Lexington, 145 Fed. 824, 76 C. C. A. 400.....	1013, 1014	U. S. v. Dietrich (C. C.) 126 Fed. 664..	77
Toof v. Martin, 13 Wall. 40, 20 L. Ed. 481.....	456	U. S. v. Dudley, 174 U. S. 670, 19 Sup. Ct. 801, 43 L. Ed. 1129.....	207
Tootle v. Coleman, 107 Fed. 41-45, 46 C. C. A. 132, 57 L. R. A. 120.....	769	U. S. v. Duluth, 1 Dill, 474, Fed. Cas. No. 15,001.....	893
Town of Roberts v. Bowes, 101 U. S. 116, 25 L. Ed. 880.....	576	U. S. v. Eaton, 144 U. S. 677, 687, 12 Sup. Ct. 764, 36 L. Ed. 591.....	271
Town of South Ottawa v. Perkins, 94 U. S. 260, 24 L. Ed. 154.....	183	U. S. v. E. C. Knight Co., 156 U. S. 1, 17, 15 Sup. Ct. 249, 255, 39 L. Ed. 325 715, 716, 721,	724
Townsend v. Beatrice Cemetery Ass'n, 138 Fed. 381, 70 C. C. A. 521.....	984	U. S. v. Erie Ry., 107 U. S. 1, 2 Sup. Ct. 83, 27 L. Ed. 385.....	764
Towns of Windham & Chaplin v. Litchfield, 22 Conn. 226, 232.....	973	U. S. v. 43 Gallons of Whisky, 93 U. S. 188, 23 L. Ed. 846.....	241
Traction Co. v. Mining Co., 196 U. S. 239, 245, 25 Sup. Ct. 251, 253, 49 L. Ed. 462.....	732, 736, 744	U. S. v. French, 1 Gall. 1, Fed. Cas. No. 15,165.....	635
Treadwell v. Wells, 4 Cal. 260.....	375	U. S. v. Gue Lim, 176 U. S. 459-467, 20 Sup. Ct. 415, 44 L. Ed. 544.....	507, 508
Tremaine v. Hitchcock, 23 Wall. 518, 23 L. Ed. 97.....	90	U. S. v. Hess, 124 U. S. 487, 8 Sup. Ct. 573, 31 L. Ed. 516.....	774
Ucayali, The (D. C.) 159 Fed. 800.....	900	U. S. v. Hoover (D. C.) 133 Fed. 950....	271
Uhlman v. Bartholomæ & Leicht Brewing Co. (C. C.) 41 Fed. 132.....	855	U. S. v. Hunter & Whitcomb (C. C.) 121 Fed. 207; 127 Fed. 1022, 61 C. C. A. 270	287
Uhlmann v. Arnholdt (C. C.) 53 Fed. 485.....	855	U. S. v. Illinois Cent. R. Co. (D. C.) 156 Fed. 182.....	403
Underwear Co., In re (D. C.) 18 Am. Bankr. Rep. 623, 153 Fed. 224.....	494	U. S. v. James (C. C.) 60 Fed. 257, 26 L. R. A. 418.....	251
Union Bridge Co. v. U. S., 204 U. S. 364, 400, 27 Sup. Ct. 367, 380, 51 L. Ed. 523.....	246, 252, 271	U. S. v. Joint Traffic Ass'n, 171 U. S. 505, 571, 19 Sup. Ct. 24, 25, 43 L. Ed. 259.....	726
Union, etc., Co. v. Lynch (C. C.) 148 Fed. 49.....	466	U. S. v. Jones, 109 U. S. 513, 3 Sup. Ct. 346, 27 L. Ed. 1015.....	734
Union Match Co. v. Diamond Match Co. (C. C. A.) 162 Fed. 148, 155.....	58, 993	U. S. v. Joyce (D. C.) 138 Fed. 459.....	774
Union Pac. R. Co. v. Chicago, R. I. & P. R. Co., 163 U. S. 600, 16 Sup. Ct. 1207, 41 L. Ed. 282.....	123	U. S. v. Ju Toy, 198 U. S. 253, 25 Sup. Ct. 644, 49 L. Ed. 1040.....	154
Union Pac. R. Co. v. U. S., 99 U. S. 700, 25 L. Ed. 496.....	577	U. S. v. Kirby, 7 Wall. 482, 486, 19 L. Ed. 278.....	517
Union R. Co. v. Dull, 124 U. S. 174, 8 Sup. Ct. 437, 31 L. Ed. 417.....	204	U. S. v. Knight, 156 U. S. 1, 15 Sup. Ct. 249, 39 L. Ed. 325.....	703, 705, 706, 725
U. S. v. American Lumber Co., 85 Fed. 827, 29 C. C. A. 431.....	445, 446	U. S. v. Lee, 106 U. S. 196, 1 Sup. Ct. 240, 27 L. Ed. 171.....	20
U. S. v. Anonymous (C. C.) 21 Fed. 761..	74	U. S. v. Legg, 105 Fed. 930, 933, 45 C. C. A. 134.....	582, 586, 589
U. S. v. Assia (C. C.) 118 Fed. 915.....	873	U. S. v. Loring (D. C.) 91 Fed. 881.....	896
U. S. v. Baker, 5 Ben. 251, Fed. Cas. No. 14,500.....	582	U. S. v. Louisville & N. R. Co. (D. C.) 157 Fed. 979.....	403
U. S. v. Baltimore & O. S. W. R. Co. (C. C. A.) 159 Fed. 33.....	403	U. S. v. Maid (D. C.) 116 Fed. 650.....	271
U. S. v. Bayard (C. C.) 16 Fed. 376.....	382	U. S. v. Marion Trust Co., 74 C. C. A. 439, 143 Fed. 301; 205 U. S. 539, 27 Sup. Ct. 794, 51 L. Ed. 1191.....	802
		U. S. v. Martin (D. C.) 28 Fed. 812.....	896
		U. S. v. Matthews (D. C.) 146 Fed. 306..	271
		U. S. v. Michigan, 190 U. S. 379, 23 Sup. Ct. 742, 47 L. Ed. 1103.....	272
		U. S. v. Morse, 161 Fed. 429.....	1023

	Page		Page
U. S. v. Nakashima, 160 Fed. 842.....	154	Vicksburg, etc., R. Co. v. Putnam, 118	
U. S. v. New York Cent. R. Co. (C. C.)		U. S. 545, 7 Sup. Ct. 1, 30 L. Ed. 257..	167
146 Fed. 298.....	77	Victor Co. v. The Fair, 123 Fed. 424, 61	
U. S. v. Noojin, 155 Fed. 377.....	1023	C. C. A. 58.....	64
U. S. v. Nye (C. C.) 4 Fed. 888.....	895	Village of London Mills v. White, 208 Ill.	
U. S. v. One Silk Rug (T. D. 28,779) 158		289, 70 N. E. 313.....	579
Fed. 974.....	583, 779	Vilter Mfg. Co. v. Otte, 84 C. C. A. 673,	
U. S. v. 1,150 $\frac{1}{2}$ Pounds of Celluloid, 82		157 Fed. 230.....	182
Fed. 627, 27 C. C. A. 231.....	583	Virginia-Carolina Chemical Co. v. Home	
U. S. v. 1,621 Pounds of Fur Clippings,		Ins. Co., 113 Fed. 1, 3, 51 C. C. A. 21..	93
106 Fed. 161, 45 C. C. A. 263.....	325		
U. S. v. Ormsbee (D. C.) 74 Fed. 207, 310	272	Wabash R. R. v. Adelbert College, 208	
U. S. v. Peters, 3 Dall. 121, 1 L. Ed. 535	18	U. S. 382, 28 Sup. Ct. 182, 52 L. Ed.	
U. S. v. Philadelphia & R. R. Co. (D. C.)		379.....	757
160 Fed. 696.....	403	Wabash R. Co. v. Skiles, 64 Ohio St. 458,	
U. S. v. Pupke (D. C.) 133 Fed. 243.....	260	60 N. E. 576.....	40
U. S. v. Salambyer, 170 U. S. 621, 18		Waco Hardware Co. v. Michigan Stove	
Sup. Ct. 661, 42 L. Ed. 1167.....	101	Co., 91 Fed. 289, 33 C. C. A. 511.....	359
U. S. v. Schefer (C. C.) 71 Fed. 959.....	101	Wailles v. Davies (C. C.) 158 Fed. 667..	399
U. S. v. Silberstein (C. C.) 153 Fed. 965..	912	Walcott v. Watson (C. C.) 46 Fed. 529..	359
U. S. v. Simmons, 96 U. S. 360, 24 L.		Walker v. Keenan, 19 C. C. A. 668, 73	
Ed. 819.....	773	Fed. 753.....	639
U. S. v. Southern Pac. R. Co. (D. C.) 157		Walker v. London & Provincial Fire Ins.	
Fed. 459.....	403	Co., 22 Irish Law Times, 84.....	407
U. S. v. Stockgrowers' Nat. Bank (C. C.)		Walker v. State Harbor Com'rs, 84 U. S.	
30 Fed. 912.....	159	648, 651, 21 L. Ed. 744.....	573
U. S. v. Trans-Missouri Freight Ass'n, 166		Walker v. Walker, 42 Ga. 135.....	687
U. S. 290, 17 Sup. Ct. 540, 41 L. Ed.		Wallace v. Adams, 74 C. C. A. 540, 143	
1007.....	242, 710, 717, 722,	Fed. 716; 204 U. S. 415, 27 Sup. Ct.	
U. S. v. 210 Half Cases of Cheese, 163		363, 51 L. Ed. 547.....	673
Fed. 369.....	583	Wallerstein v. Ervin, 7 Am. Bankr. Rep.	
U. S. v. Union Pac. R., 91 U. S. 81, 23		236, 112 Fed. 124, 50 C. C. A. 129....	511
L. Ed. 224.....	360	Warner v. Baltimore & O. R. Co., 168 U.	
U. S. v. Whittier, Fed. Cas. No. 16,688..	260	S. 339, 18 Sup. Ct. 68, 42 L. Ed. 491..	793
U. S. v. Wood (D. C.) 159 Fed. 187.....	655	Warner v. Smith, 84 O. G. 311.....	193
United States Freehold L. E. Co. v. Galle-		Warren Co. v. Landauer (C. C.) 151 Fed.	
hos, 89 Fed. 769, 32 C. C. A. 470.....	497	130.....	89
United States Hog Hoisting Mach. Co. v.		Washington v. Opie, 145 U. S. 214, 12	
North Packing & Provision Co. (C. C.		Sup. Ct. 822, 36 L. Ed. 680.....	322
A.) 158 Fed. 818.....	557	Watt v. Jones, 60 Kan. 201, 56 Pac. 16..	176
United States Trust Co. v. Wabash R.		Watts v. Sachs, 190 U. S. 1, 23 Sup. Ct.	
Co., 150 U. S. 287, 14 Sup. Ct. 86, 37		718, 47 L. Ed. 933.....	826
L. Ed. 1085.....	104	Weiss v. Bethlehem Iron Co., 88 Fed. 30,	
Universal Adding Mach. Co. v. Comptog-		31 C. C. A. 363, 370.....	669
raph Mach. Co., 146 Fed. 982, 77 C. C.		Weiss-Chapman Drug Co. v. People, 39	
A. 227.....	193	Colo. 374, 378, 89 Pac. 778.....	176
Updegraff v. Marked Tree Lumber Co., 83		Welch v. Louis, 31 Ill. 446, 455.....	842
Ark. 154, 103 S. W. 606, 607.....	965	Welhaven, The (D. C.) 55 Fed. 80.....	899
Van Buren v. Digges, 11 How. 461-476,		Wells v. Black, 117 Cal. 157, 163, 48 Pac.	
13 L. Ed. 771.....	597	1090, 37 L. R. A. 619, 59 Am. St. Rep.	
Vance v. Campbell, 1 Black, 427, 430, 17		162.....	683
L. Ed. 168.....	694	West v. Aurora, 6 Wall. 139, 18 L. Ed.	
Vanderbilt v. Eidman, 146 Fed. 23, 76 C.		819.....	359, 362, 363
C. A. 481; 196 U. S. 480, 489, 490, 492,		West v. Bank, 16 Okl. 328, 85 Pac. 469..	1013
495, 498, 501, 25 Sup. Ct. 331, 334, 49		West v. Cambden, 135 U. S. 507, 10 Sup.	
L. Ed. 563.....	164, 166, 167, 168,	Ct. 838, 34 L. Ed. 254.....	177
	462, 464, 465, 467,	West v. Hitchcock, 205 U. S. 80, 27 Sup.	
Van Lear v. Eisele (C. C.) 126 Fed. 823..	801	Ct. 423, 51 L. Ed. 718.....	673
272		West v. Randall, 2 Mason, 193, Fed. Cas.	
Vannini v. Paine, 1 Har. 65.....	240	No. 17,424.....	480
Van Patten v. Chicago, M. & St. P. R.		Western Electric Co. v. Sperry Electric	
Co. (C. C.) 74 Fed. 981.....	291	Co., 58 Fed. 186, 7 C. C. A. 164.....	194
Vaughan v. Northrup, 15 Pet. 1, 5, 10 L.		Western Loan & Savings Ass'n v. Butte	
Ed. 639.....	822	& B. Min. Co., 210 U. S. 368, 28 Sup.	
Veazie v. Moor, 14 How. 573, 14 L. Ed.		Ct. 720, 52 L. Ed. 1101.....	768, 769, 770
545.....	245	Western Tie & Timber Co. v. Brown, 196	
Vetaloro v. Perkins (C. C.) 101 Fed. 393		U. S. 502, 25 Sup. Ct. 339, 49 L. Ed.	
264,	268	571.....	125
Vicksburg, etc., R. Co. v. Dennis, 116 U.			
S. 667, 6 Sup. Ct. 625, 626, 29 L. Ed.			
770.....	575, 576		

Page		Page
	Western Union Tel. Co. v. Ann Arbor R. Co., 178 U. S. 239, 20 Sup. Ct. 867, 44 L. Ed. 1052.....	608
	Western Union Tel. Co. v. Baker, 140 Fed. 315, 319, 72 C. C. A. 87, 91....	830
	Western Union Tel. Co. v. Com., 125 U. S. 530, 8 Sup. Ct. 961, 31 L. Ed. 790....	572
	Western Union Tel. Co. v. Myatt (C. C.) 98 Fed. 335, 344.....	648
	Western Union Tel. Co. v. New Hope, 187 U. S. 419, 23 Sup. Ct. 204, 47 L. Ed. 240.....	603
	Western Union Tel. Co. v. New York (C. C.) 38 Fed. 552, 560, 3 L. R. A. 449....	571
	Western Union Tel. Co. v. Pennsylvania R. Co. (C. C.) 120 Fed. 367; 195 U. S. 540, 594, 25 Sup. Ct. 133, 150, 49 L. Ed. 312, 332.....	570
	Western Union Tel. Co. v. Visalia, 149 Cal. 744, 87 Pac. 1023.....	571
	Westinghouse v. Hien (C. C. A.) 159 Fed. 936.....	81
	Westinghouse Air Brake Co. v. Chicago Brake & Mfg. Co. (C. C.) 85 Fed. 787....	204
	Westinghouse, etc., Co. v. Callaghan, 83 C. C. A. 869, 155 Fed. 397.....	182
	West St. Louis Sav. Bank v. Shawnee Co., 95 U. S. 557, 24 L. Ed. 490.....	159
	Weyerhauser v. Minn., 176 U. S. 550, 20 Sup. Ct. 485, 44 L. Ed. 583.....	761
	Whalen v. Gordon, 95 Fed. 305, 37 C. C. A. 70.....	972
	Wharton v. Stoutenburgh, 35 N. J. Eq. 266.....	950
	Wheeler v. Abilene Nat. Bank Bldg. Co. (C. C. A.) 159 Fed. 391, 392.....	811
	White, Ex parte, L. R. 1870, 6 Ch. App. Cas.....	805
	White v. Benjamin, 150 N. Y. 258, 44 N. E. 956.....	140
	White v. Daman, 7 Ves. 35.....	113
	White v. Ewing, 159 U. S. 36, 38, 15 Sup. Ct. 1018, 40 L. Ed. 67.....	93, 95, 96, 98
	White v. U. S., 191 U. S. 545, 550, 24 Sup. Ct. 171, 48 L. Ed. 295.....	261
	White-Smith Co. v. Apollo Co., 209 U. S. 14, 28 Sup. Ct. 319, 52 L. Ed. 655.....	364
	Whitney v. Butler, 118 U. S. 655, 7 Sup. Ct. 61, 30 L. Ed. 266.....	832
	Whitney v. Dresser, 200 U. S. 532, 26 Sup. Ct. 316, 50 L. Ed. 584.....	278
	Whitney v. Taylor, 153 U. S. 85, 93, 95, 96, 15 Sup. Ct. 796, 800, 801, 39 L. Ed. 906.....	918, 919
	Wichita v. Missouri & K. Tel. Co., 70 Kan. 441, 78 Pac. 886, 890.....	579
	Wiley v. Sinkler, 179 U. S. 58, 65, 21 Sup. Ct. 17, 45 L. Ed. 84.....	988
	Wilkins Shoe Button Co. v. Webb (C. C.) 89 Fed. 982.....	697
	Wilkins v. U. S., 96 Fed. 837, 37 C. C. A. 588.....	275
	Willard v. Tayloe, 8 Wall. 557, 19 L. Ed. 501.....	118
	Williams v. Bowers, 15 Cal. 321, 76 Am. Dec. 489.....	375
	Williams v. Crabb, 117 Fed. 193, 54 C. C. A. 213, 59 L. R. A. 425.....	480
	Williams' Estate, In re, 156 Fed. 934, 84 C. C. A. 434.....	312
	Williamson v. U. S., 207 U. S. 425, 451, 28 Sup. Ct. 163, 52 L. Ed. 273.....	139
	Wilson v. Consolidated Store Service Co., 88 Fed. 286, 287, 31 C. C. A. 533....	617, 618
	Wilson v. Gaylord, 77 Ark. 479, 92 S. W. 26.....	965
	Wilson v. Pennsylvania Trust Co., 8 Am. Bankr. Rep. 169, 114 Fed. 742, 52 C. C. A. 374.....	487
	Wilson v. People, 94 Ill. 299.....	158
	Wilson v. Wilson, 154 Mass. 194, 28 N. E. 167, 12 L. R. A. 524, 26 Am. St. Rep. 237	552
	Winchester v. Howard, 136 Cal. 432, 444, 446, 447, 64 Pac. 692, 69 Pac. 77, 89 Am. St. Rep. 153.....	677
	Winona & St. P. Land Co. v. Minnesota, 159 U. S. 526, 16 Sup. Ct. 83, 40 L. Ed. 247.....	762
	Wisner, Ex parte, 203 U. S. 449, 27 Sup. Ct. 150, 51 L. Ed. 264.....	766, 767, 770
	Wisner v. Barnett, 4 Wash. C. C. 631, 642, Fed. Cas. No. 17,914.....	280
	Withrow v. Citizens' Bank, 55 Kan. 378, 40 Pac. 639.....	555
	Wood v. Carpenter, 101 U. S. 135, 140, 141, 25 L. Ed. 807.....	321, 346
	Wood v. Dummer, 3 Mason, 308, Fed. Cas. No. 17,944.....	480
	Wood v. Greenwood Hardware Co., 75 S. C. 383, 55 S. E. 973, 9 L. R. A. (N. S.) 501	721
	Wooster v. Crane, 147 Fed. 515, 77 C. C. A. 211.....	64
	Worcester Co., In re, 102 Fed. 808, 812, 42 C. C. A. 637.....	312
	Worthington v. Robbins, 139 U. S. 337, 11 Sup. Ct. 581, 35 L. Ed. 181.....	207
	Wright v. Mattison, 18 How. 56, 15 L. Ed. 280.....	439
	Wright v. Nagle, 101 U. S. 791, 794, 25 L. Ed. 921.....	576
	Wright v. Randel (C. C.) 8 Fed. 591, 599....	50
	Wright v. William Skinner Mfg. Co. (C. C. A.) 162 Fed. 315.....	130
	Wulf v. Kansas City (Kan.) 94 Pac. 207....	741
	Wycoff v. Hulse, 32 N. J. Eq. 697.....	687
	Yick Wo v. Hopkins, 118 U. S. 356, 6 Sup. Ct. 1064, 30 L. Ed. 220.....	236, 576
	Yonge v. Broxson, 23 Ala. 684.....	972
	York Mfg. Co. v. Cassell, 201 U. S. 344, 26 Sup. Ct. 481, 50 L. Ed. 782, 15 Am. Bankr. Rep. 633.....	485, 554
	Young, Ex parte, 209 U. S. 123, 28 Sup. Ct. 441, 52 L. Ed. 714, 13 L. R. A. (N. S.) 932.....	20
	Young, Matter of, 145 N. Y. 535, 538, 40 N. E. 226.....	469
	Young v. Merkel, 163 Pa. 513-520, 30 Atl. 196.....	669
	Young v. Tibbitts, 32 Wis. 79.....	375
	Youngberg v. Walsh, 72 Kan. 220, 83 Pac. 972.....	554
	Yukon Woolen Co., In re (D. C.) 2 Am. Bankr. Rep. 805, 96 Fed. 326.....	623
	Zeiger v. Pennsylvania R. Co. (C. C.) 151 Fed. 348.....	263
	Zollar v. Janvrin, 47 N. H. 328.....	375

CASES ON REHEARING.

CASES IN WHICH REHEARINGS HAVE BEEN GRANTED OR DENIED.

Lewis Blind Stitch Mach. Co. v. Premium Mfg. Co.....	163 Fed. 950
Rehearing denied. Oct. 6, 1908.	
Nowell v. McBride.....	162 Fed. 432
Rehearing denied. Dec. 2, 1908.	

164 F.

(xxxii)†

CASES

ARGUED AND DETERMINED

IN THE

UNITED STATES CIRCUIT COURTS OF APPEALS AND THE CIRCUIT AND DISTRICT COURTS.

MURRAY et al. v. WILSON DISTILLING CO. et al.

(Circuit Court of Appeals, Fourth Circuit. September 15, 1908.)

No. 821.

1. COURTS—JURISDICTION OF FEDERAL COURTS—SUIT AGAINST STATE.

For a number of years a "State Dispensary," created by an act of the Legislature of South Carolina, conducted all of the liquor business within the state. February 16, 1907 (Sess. Laws 1907, p. 480, § 47), the Legislature abolished the dispensary, and on the same day passed an act (Sess. Laws 1907, p. 835, §§ 1, 3, 5), authorizing the Governor to appoint a commission of five members, to be known as the "State Dispensary Commission," whose duty it should be to close out the business of the dispensary by selling its property and collecting all debts due it; "and by paying from the proceeds all just liabilities at the earliest date practicable," and to pay into the state treasury "all surplus funds on hand after paying all liabilities." *Held*, that such commissioners were not officers of the state, performing for it any functions of government, but merely agents for converting the property of the dispensary into cash and paying its debts; that they held the fund realized therefrom as trustees for the benefit primarily of the creditors; and that a suit in a federal court by such creditors against them to have the amounts due determined and paid from the fund was not one against the state, of which the court was without jurisdiction under the eleventh constitutional amendment—the state having no interest, except in the surplus remaining after the debts were paid.

[Ed. Note.—For cases in point, see Cent. Dig. vol. 13, Courts, § 844½.]

2. SAME—TRUSTS—EQUITY—JURISDICTION—ENFORCEMENT OF TRUST.

In such case the creditors could maintain a suit in equity to enforce the carrying out of the trust by the commission on its refusal to pay their claims from funds in its hands, and for an injunction and the appointment of a receiver in aid of such relief, and to such a suit the state was not a necessary party.

3. SAME—INJUNCTION—FEDERAL COURTS—STAYING PROCEEDINGS IN STATE COURT—"COURT."

The commission appointed under such authority does not constitute a "court," within the meaning of Rev. St. § 720 (U. S. Comp. St. 1901, p. 581), prohibiting the granting of injunctions by federal courts to stay proceedings in a state court.

[Ed. Note.—For other definitions, see Words and Phrases, vol. 2, pp. 1672-1682; vol. 3, p. 7622.]

4. SAME—FEDERAL COURTS—FOLLOWING STATE DECISIONS.

A federal court is not bound to follow a decision of the highest court of a state construing a state statute in a suit involving rights which previously accrued and for the protection of which relief had previously been granted on a different construction.

Appeal from the Circuit Court of the United States for the District of South Carolina, at Charleston.

For opinion below, see 161 Fed. 162.

In 1892 the South Carolina Legislature passed an act establishing what was called a "State Dispensary." Under the provisions of this act private individuals were forbidden to engage in either the manufacture or sale of intoxicating liquors of all kinds and the right to carry on the liquor business in the state of South Carolina was reserved to the state. The act provided for a board of control of the dispensary, consisting of the Governor, the Comptroller General, and Attorney General, and to this board was committed the duty of conducting and managing the State Dispensary. The business of the dispensary, under and by virtue of the act referred to, was inaugurated under the control of the agencies designated and became the only legalized method of dealing in intoxicating liquors within the state. Among other provisions of the act were that a state commissioner should be appointed by the Governor, and that said commissioner should turn over monthly to the Treasurer of the state the amount received from sales of liquors made by him, and the Treasurer was required to keep a separate account of said fund, and the commissioner was authorized, with the approval of the board of control, from time to time to draw warrants upon the funds in the hands of the Treasurer for the amounts necessary to pay the expenses incurred in conducting the business. It was also provided that in counties complying with the requirements of the act county dispensaries might be established, and these latter were required to buy supplies of liquor from the State Dispensary, and the State Dispensary was required to sell to the county dispensaries supplies and intoxicating liquors at a profit of not more than 50 per cent. At the outset there was appropriated by the state for the purpose of starting the dispensary system the sum of \$50,000, which amount has since been repaid to the state from the dispensary receipts. In the year 1896 the board of control was changed, so that, instead of being constituted as above set forth, it was made to consist of five members, to be elected by the General Assembly, each of said members being required to give a bond in the sum of \$10,000, and the control and management of the dispensary was conferred by law upon them. This board, as above stated, was required to furnish liquor to the county dispensers, and the latter were required to remit the net proceeds of the sale of liquor to the State Treasurer. All bills for the purchase of liquor were paid by the State Treasurer upon warrants drawn by the commissioner. Thus the sale of intoxicating liquors was conducted in South Carolina under the several acts of the Legislature of that state and by the machinery provided for the purchase of liquors by the commissioner under the direction of the board of control of the State Dispensary and sale of liquors by the State Dispensary to the county dispensers, who, in turn, sold and remitted the money arising from the sales to the State Treasurer; the expenses of operating the State Dispensary, together with all bills for spirits purchased, being paid by the State Treasurer from the dispensary fund, which was kept separate, upon warrants of the commissioner, approved by the board of control. By the acts of 1902 all net income derived by the state from the sale of liquors in the state under the dispensary law was required to be apportioned among the several counties of the state for the benefit of the common schools in proportion to the deficiencies existing in the counties, etc.; and the said acts further required that the directors of the State Dispensary should pay over to the State Treasurer by January 1, 1904, in equal semiannual payments, all of the school fund reported by them in excess of \$400,000 for the benefit of the common schools of the state, to be apportioned as above stated. The business of the State Dispensary continued from the date of its estab-

ishment in 1892 until the year 1907, when the General Assembly of South Carolina passed an act entitled "An act to declare the law in reference to, and regulate the manufacture and sale, use, etc., of, liquors and beverages within the state and police the same." By section 47 of this statute it was enacted that the State Dispensary be abolished. This act was approved on the 16th day of February, 1907. Sess. Laws 1907, p. 480. At the same session of the Legislature another act was passed (Sess. Laws 1907, p. 835), which was approved on the same day as the last-named act, entitled "An act to provide for the disposition of all property connected with the State Dispensary and to wind up its affairs," which is as follows:

"Session Laws S. C. 1907. No. 402.

"An act to provide for the disposition of all property connected with the State Dispensary, and to wind up its affairs.

"Section 1. Be it enacted by the General Assembly of the state of South Carolina, that immediately upon the approval of this act, the Governor shall appoint a commission of well-known business men, consisting of five members, none of whom shall be members of the General Assembly, to be known as the State Dispensary Commission, who shall each give bond for the faithful performance of the duties required, in the sum of \$10,000.

"Sec. 2. Said commission shall immediately organize by the election of a chairman and a secretary from their number.

"Sec. 3. It shall be the duty of said commission to close out the entire business and property of the State Dispensary, except real estate, and including stock in the several county dispensaries by disposing of all goods and property connected therewith, by collecting all debts due and by paying from the proceeds thereof all just liabilities at the earliest date practicable. Said commission shall be at liberty to make such disposition upon such terms, times and conditions as their judgment may dictate: Provided, that no alcoholic liquors or beers shall be disposed of within the state except to county dispensary boards, and all liquors illegally bought by the present management may be returned to the persons, firms or corporations from whom purchased, and for determining the legality of said purchases, they are hereby authorized and directed to investigate fully the circumstances surrounding all contracts for liquors, and to employ such assistant counsel as may be approved by the Attorney General, and such expert accountants and stenographers and any other person or persons the commission may deem necessary for the ascertainment of any fact or facts connected with said State Dispensary and its management or control at any time in the past, and to take testimony, either within or without the state: Provided, further, that all payments shall be made in gold and silver coin of the United States, in United States currency, or in national bank notes.

"Sec. 4. The compensation of each member of said commission shall be \$5 per day for each day actually employed about the business, and actual expenses for the time engaged: Provided, that they shall receive no compensation for services rendered on this commission after January 1, 1908.

"Sec. 5. The said commission shall pay to the State Treasurer, after deducting their compensation and other expenses allowed by this act, all surplus funds on hand after paying all liabilities.

"Sec. 6. The said commission is hereby authorized to employ such book-keepers, accountants, clerks, assistants and employes as they may deem necessary, and to contract with them at the time of employment for their compensation.

"Sec. 7. The said commission shall submit to the Governor at the earliest day practicable, a complete inventory of all property received by them, with a statement of the liabilities of the State Dispensary, and as soon as the affairs are liquidated, a report in full of their actings and doings.

"Sec. 8. That said commission shall have full power and authority to investigate the past conduct of the affairs of the dispensary, and all the power and authority conferred upon the committee appointed to investigate the affairs of the dispensary, as prescribed by an act to provide for the investiga-

tion of the dispensary, approved January 24, A. D. 1906, be, and hereby is, conferred upon the commission provided for under this act: Provided, that for the purpose of the investigation of the affairs of the dispensary as herein provided, each and every member of said commission be, and hereby is, authorized and empowered, separately and individually, or collectively, to exercise the power and authority herein conferred upon the whole commission.

"Approved the 16th day of February, A. D. 1907."

By virtue of this act W. J. Murray, John McSween, B. F. Arthur, C. K. Henderson, and Avery Patton were duly appointed and qualified as commissioners, and they entered upon the discharge of their duties as such. They proceeded to sell the personal property and collect the debts due to the dispensary, and the State Treasurer of South Carolina paid over to them about \$129,000 which he had in hand standing to the credit of the dispensary fund, and altogether, from the sale of the property, the collection of debts, and the amount paid over by the State Treasurer, there came to the hands of these commissioners about the sum of \$800,000 to be administered by them under the provisions of the law above set out. The money thus realized from time to time, received by the defendants, who constitute the State Dispensary Commission, was, at the time of the commencement of this suit, in the hands of the commission or deposited in banks in the state of South Carolina, subject to the check of the commission, and no part of the said money is in the treasury of the state of South Carolina, or has been in any way mingled with the funds of the said state, but has been kept separate and apart in the hands of said commission, subject to its absolute control and disposition. The total amount of claims for liquors and supplies furnished, outstanding against the State Dispensary, was about \$600,000, held by various corporations, partnerships, and persons, among whom were the original complainants and the several intervening complainants in this action. It further appears from the record that the complainants furnished to the defendants, at their request, itemized statements of their accounts against the State Dispensary, and the said accounts were, by comparison with the books kept by the dispensary, found to be in substantial agreement with said books. It further appears that the accounts of complainants were audited at the instance of the defendants and that the several amounts which are claimed were found to be correct.

As the several complainants and interveners in this action base their rights practically upon the same grounds, we will, in order to avoid confusion in the further presentation of the case, treat alone of the claim of the Fleischmann Company, one of the original complainants; the balance due said company being, as alleged, the sum of \$66,501.10, which said claim, as before stated, was presented to the Dispensary Commission, was compared with the books kept by the State Dispensary, and also audited, as above stated, and found to be, as alleged, substantially correct. This complainant alleges further that this claim was duly presented to the Dispensary Commission, and payment thereof demanded, before the bringing of this action, and defendants refused to pay the same, or any part thereof. It further appears that at the time the defendants took charge of the affairs of the State Dispensary, to close them up under the provisions of the act of the Legislature, there was, among other liquors on hand, some of that which had been bought from the Fleischmann Company, and by agreement between the complainant and the commission this was returned to the complainants and credited on the claim of the latter. It also appears that other liquors and supplies for which the complainant the Fleischmann Company makes claim had been disposed of by the State Dispensary authorities, in the course of the operations of the dispensary, before the defendants in the present action took charge.

In order to give a full understanding of the questions presented, we set out the original bill filed by the Fleischmann Company, with the answer of the respondents thereto. This complainant afterwards filed an amended and supplemental bill; but it is not deemed necessary to set it out, as the original bill and return, or answer thereto, together with the statement of facts heretofore given, present clearly the questions to be considered.

Bill of complaint, filed January 23, 1908:

"In the Circuit Court of the United States for the District of South Carolina, Fourth Circuit, at Columbia.

"The Fleischmann Company, Complainant, v. W. J. Murray, John McSween, B. F. Arthur, C. K. Henderson, and Avery Patton, Constituting the State Dispensary Commission of South Carolina, and W. J. Murray, John McSween, B. F. Arthur, C. K. Henderson, and Avery Patton, Individually, Defendants. In Equity.

"To the Honorable Judges of the Circuit Court of the United States for the District of South Carolina:

"The Fleischmann Company, a corporation organized and existing under and by virtue of the laws of the state of Ohio, and a citizen of said state, brings this its bill against W. J. Murray, John McSween, B. F. Arthur, C. K. Henderson, and Avery Patton, constituting the State Dispensary Commission of the state of South Carolina, and said defendants individually, all of whom are citizens and residents of said state of South Carolina, and thereupon your orator complains and says:

"(1) That your orator, the Fleischmann Company, was at all times hereinafter mentioned, and still is, a corporation duly created, organized, and existing under and by virtue of the laws of the state of Ohio, and is a citizen and resident thereof, having its principal office in the city of Cincinnati, in said state, and that the defendant W. J. Murray is a citizen and resident of the state of South Carolina, residing at Columbia, in said state; the defendant John McSween is a citizen and resident of said state of South Carolina, residing at Timmonsville, in said state; the defendant B. F. Arthur is a citizen and a resident of the state of South Carolina, residing at Union, in said state; that the defendant C. K. Henderson is a citizen and resident of the state of South Carolina, residing at Alken, in said state; and the defendant Avery Patton is a citizen and resident of the state of South Carolina, residing at Greenville, in said state.

"(2) And your orator further shows that many years prior to the passage of the act hereinafter mentioned there was duly created and established by law in the state of South Carolina an institution for the purpose of buying, selling, and distributing alcoholic liquors within said state, known as the 'State Dispensary,' and that by the terms of the law creating and establishing said dispensary the managing agents or officers thereof were duly authorized, directed, and empowered to purchase in its name and on its behalf all kinds of spirituous, vinous, and malt liquors, and to pledge the credit of the said State Dispensary for the payment of the same.

"(3) And your orator further shows that the General Assembly of the state of South Carolina, at its session held in the year 1907, for the purpose of discontinuing said State Dispensary, disposing of its assets, and paying off its creditors, passed an act entitled "An act to provide for the disposition of all property connected with the state dispensary and to wind up its affairs, which said act is in words and figures as follows: [The bill here sets out in full the act of the South Carolina Legislature of February 16, 1907, which is copied in the statement of facts hereinbefore.]

"(4) That the said act was duly approved on the 16th day of February, 1907, and within a short time thereafter the commission therein provided for was created by the appointment of the defendants as commissioners, and said defendants, having duly qualified and organized pursuant to said act, became and do now constitute the State Dispensary Commission, and as such are charged with the execution of all the powers conferred and the performance of all the duties imposed upon said commission by the said act.

"(5) That immediately upon their qualification and organization as hereinbefore alleged the defendants entered upon the discharge of said duties, and in accordance with the directions contained in said act took possession and control of the entire business and property of the State Dispensary, and have, as your orator is informed and believes, sold said property and collected the debts due to said State Dispensary, and the proceeds arising from said sale and collection are, or ought to be, in the hands of said defendants, applicable

to the payment of the liabilities of said State Dispensary, and to the other uses and purposes designated in said act.

"(6) And your orator further shows that, prior to the passage of the said act of 1907, providing for a sale of the property of the said State Dispensary and the winding up of its affairs, and while the said State Dispensary was still engaged in business, your orator sold and delivered to it, at prices which were entirely reasonable and mutually satisfactory, a large quantity of valuable whiskies and other spirituous liquors, all of which whiskies and liquors were received and accepted by said State Dispensary, and had been, except as hereinafter alleged, sold or disposed of by it at a substantial profit; that the sales so made by your orator were in every respect regular and legal, and were made upon orders properly and lawfully given by the persons duly authorized to give such orders; and the whiskies were delivered to said State Dispensary under a contract, promise, and agreement that your orator should be paid the prices charged therefor, and the said State Dispensary became, and was at the time of the passage of said act, and at the time the defendants took charge of said business and property, and still is, justly indebted to your orator for the same.

"(7) That within a short time after the appointment and qualification of the defendants and their organization as the State Dispensary Commission your orator, being desirous of having its account against the State Dispensary settled, and in order that all differences might be reconciled, or disputes, if any, adjusted, and the amount due to your orator fixed and determined, filed with said defendants an itemized statement of its account, and requested the defendants to have the same audited, so that it could be passed upon; that thereafter the defendants notified your orator that there was still on hand and undisposed of a portion of the whisky which your orator had sold to the said State Dispensary, and asked your orator to take back said whisky and allow a credit therefor, then and there holding out as an inducement to your orator for so doing that if they were permitted to return said goods it would greatly facilitate a settlement with your orator, and enable them to make a much earlier payment of the account; and your orator, being anxious to remove every possible cause of delay in obtaining a settlement of its claim, did take back all of said goods and give credit therefor at the invoice price thereof.

"(8) That on or about the 24th day of May, 1907, the defendants advised your orator that, in comparing its account with the books kept by the State Dispensary, they had discovered a discrepancy between the amount claimed by your orator and the amount shown by said books to be due of \$292.14, growing out of certain credits to which the said State Dispensary was entitled, and which your orator had failed to allow, but that in every other particular your orator's account was, according to the audit made by the defendants, correct, and corresponded with the said books, and that if your orator would allow said credit there would be no further dispute as to the amount due to your orator; and your orator, being still anxious to get its account adjusted and receive payment of the same, did consent that said sum might be deducted, and thereupon it was agreed between your orator and the defendants that there was on the date above mentioned a balance of \$66,501.19 justly due and owing to your orator by the said State Dispensary, which said sum the defendants then and there agreed to pay; but, notwithstanding your orator has made frequent demands on them, they have refused and still refuse to pay the same.

"(9) And your orator further shows that, as it is informed and believes, the defendants have received from the sale of the property of the State Dispensary and the collection of debts due it, and now have in their hands, a large sum of money, amounting to upwards of \$800,000, and that this sum, if properly preserved and applied, will be amply sufficient to pay off and discharge the claim of your orator and all other just liabilities of said State Dispensary, which said liabilities do not, as your orator is informed and believes, exceed the sum of \$609,000, all of which facts will more fully appear from the report made by the defendants to the Governor of the state of South Carolina on or about the 4th day of January, 1908, to which report reference is hereby made for the ascertainment of said amounts.

"(10) That, as your orator is advised and believes, the money received by the defendants and held by them as hereinbefore alleged, having been placed in their possession for the specific purpose of paying all the just liabilities of the State Dispensary, became and now constitutes a trust fund in the hands of said defendants, and the said defendants hold the same as trustees for your orator and the other creditors of the said State Dispensary, and, the amount due your orator having been determined and agreed upon, your orator is entitled to have said amount immediately paid to it out of said fund.

"(11) And your orator further shows that said defendants are abusing the trusts reposed in them by wrongfully and unlawfully failing and refusing to carry out the terms and provisions of said act of 1907 of the General Assembly of the state of South Carolina, and that the greater part of the money which the defendants have received as aforesaid has been on deposit for many months, and is now on deposit, in certain banks in the state of South Carolina, in which banks the said defendants, or some of them, are respectively interested, either as officers, stockholders, or directors; that a large sum of said money is now in the National Loan & Exchange Bank of Columbia, in which bank the defendant Murray, who is the chairman of the Dispensary Commission, is a large stockholder and a director; that another large portion of said money is deposited in the Bank of Timmons ville, in which said bank the defendant McSween is a stockholder and a director, and is also its president; that another large portion of said money is on deposit in the People's Bank of Union, in which bank the defendant Arthur is a stockholder and a director, and also its president; that another large portion of said money is on deposit in the Bank of Aiken, in which bank the defendant Henderson is a stockholder and director; that another portion of said money is deposited in the Piedmont Savings & Investment Company of Greenville, in which the defendant Patton is a stockholder and director; and a portion of said money is deposited in the Merchants' & Farmers' Bank of Cheraw, in which bank one W. F. Stevenson, who resides in the said town of Cheraw, and who is the attorney for the defendants constituting the State Dispensary Commission, is a stockholder and director, and also its president. That the said defendants have wrongfully, unlawfully, and fraudulently declined and refused to make distribution of the said money among the creditors of said State Dispensary, or to pay the claim of your orator, or any of the other of said creditors, for the reason, as your orator verily believes and alleges the fact to be, that there has been formed and now exists an unlawful understanding or agreement between the defendants, by which it has been decided that the money deposited in the banks above named shall be held and allowed to remain as long as possible in said banks and be used by them for their own benefit and profit.

"(12) And your orator further shows that there are a large number of persons claiming to be creditors of the said State Dispensary and seeking to collect from the defendants various sums, ranging in amount from one to many thousand dollars; that some of said persons, for the purpose of compelling the payment of their debts, have already brought suit against said defendants, and others are, as your orator is informed and believes, threatening to institute similar actions; and if the defendants shall be required or permitted to defend a multiplicity of such suits in order to determine the validity of each claim against them, and shall be allowed, as they have declared their intention to do, to defer the payment of all claims until the final termination of said suits, a large part of the funds in their hands will be wasted in expensive litigation and court costs, and a great wrong, injury, and injustice will be done to your orator and the other creditors, whose claims are admitted to be just and correct, and about which there is and can be no dispute.

"(13) And your orator further shows that, although the said defendants have in their hands the large sum of money hereinbefore mentioned, and although they are wrongfully and unlawfully retaining said money for the use and benefit of institutions in which they are personally interested, and are wrongfully and unlawfully refusing to carry out and perform the duties and trusts imposed upon them by the General Assembly of the state of South Carolina, the said defendants have only given bonds in the sum of \$10,000 each, and they are now, as your orator is informed and believes, threatening to take measures to have an act passed by the General Assembly of South Caro-

lina terminating their commission and providing for a transfer of the money in their hands to the State Treasurer, which money ought to be applied to the payment of the debts due to your orator and the other creditors of the said State Dispensary, and thus, if possible, place the same beyond the reach, or by some other means, impair the contract rights, of your orator and said other creditors; and, as your orator is advised and believes, unless the defendants are restrained and enjoined from exercising any control over or in any way interfering further with said fund, the said defendants will waste or wrongfully divert the same, to the great and irreparable damage of your orator and all the other creditors of the State Dispensary.

"(14) And your orator further shows, upon information and belief, that there is a very wide difference between the opinions of the defendants as to the duties required of them as members of the Dispensary Commission, and the proper manner of performing said duties; that the defendant B. F. Arthur, although still a member of said commission, has declined and refused to take any further part in the proceedings thereof, and has not, for at least eight months, attended any of the meetings of said commission, or participated in any of its deliberations; that the other four defendants, as members of said commission, are about equally divided as to what course ought to be pursued with reference to the ascertainment of the just liabilities of the State Dispensary and the payment of the same, and that by reason of such division the said defendants have become engaged in a dispute among themselves, which renders it almost impossible for them ever to agree upon any plan by which to carry out the provisions of the act of 1907 of the General Assembly of South Carolina and to execute the trust imposed upon them by said act; and, as your orator is advised and believes, unless this honorable court shall take charge of the trust fund now in the hands of the defendants as members of said commission, and administer the same in accordance with the provisions of the said act of 1907, your orator and the other creditors of said State Dispensary will, to their great and irreparable damage, be indefinitely delayed in the collection of their claims.

"(15) And your orator further shows, upon information and belief, that the defendants now allege and pretend that there were certain irregularities and fraud in connection with some of the sales of liquors made to the former officers of the State Dispensary, and the defendants have entered into an unlawful combination or conspiracy with one J. Fraser Lyon, the present Attorney General of the state of South Carolina, and under whose advice said defendants are acting, to aid the said Lyon in carrying out his frequent threats to prosecute and imprison said officers, and to that end have agreed among themselves and with said Lyon to withhold the payment of the claim of your orator and all other creditors until the said Lyon has obtained such evidence as may be sufficient to prove the guilt and secure the conviction of said officers; that under and pursuant to this agreement, combination, or conspiracy the defendants have refused and are still refusing to carry out the provisions of the act of 1907, and to pay the claim of your orator and the other just liabilities of said State Dispensary, although the account of your orator has been duly audited, the amount claimed admitted to be justly due and payable as hereinbefore alleged, and notwithstanding the fact that the defendants have never made any pretense or claim that either of the sales made by your orator was in any respect irregular, illegal, or fraudulent, and notwithstanding the frequent promises and agreements by the defendants to pay the amount so admitted to be due.

"(16) And your orator further shows that, notwithstanding the fact that the amount claimed by your orator has been admitted by the defendants to be a just liability against the said State Dispensary, and now due and payable out of the fund in their hands, and although the said defendants have never claimed or pretended that said amount was subject to any offsets, credits, or counterclaims, your orator is ready, able, and willing, if this honorable court shall direct that the amount due to it be immediately paid, to execute and deliver to the said defendants a good and sufficient bond in such sum as may be required by this honorable court, to the full amount of its claim, if necessary, conditioned to pay to the said defendants all such amounts as may be, upon the hearing of this cause, found and adjudged to be due by

your orator to these defendants by way of offsets, reduction, credit, counterclaim, or otherwise.

"In consideration whereof, and forasmuch as your orator is without remedy and can obtain adequate relief only in a court of equity, and to the end that the defendants may be prevented from committing further wrongs and trespasses against the rights of your orator, and for the purpose of preserving the funds in the hands of the defendants and of enforcing the rights and equities of your orator in and to the same, and preventing further waste, loss, and damage, by reason of the facts alleged in this bill, your orator prays:

"(1) That this honorable court will either forthwith appoint a receiver to take charge of and administer as a trust fund all the money now in the hands of the defendants arising out of the sale of property belonging to the State Dispensary of South Carolina, or from the collection of debts due it, or direct and decree that the amount admitted to be due to your orator be immediately paid to it upon the execution by your orator of a good and sufficient bond, to be approved by the court and conditioned to pay to the defendants all such sum or sums as may be found to be due them by your orator and adjudged to be paid by it.

"(2) That the defendants, their agents, servants, attorneys, and employes be restrained and enjoined from disposing of or paying out, or in any manner interfering further with, said fund, or any part thereof, except to transfer the same to the receiver appointed by the court, or to pay the amount due to your orator, as the court may direct.

"(3) That it be referred to a master to ascertain and determine the amount due to your orator for goods sold and delivered by it to the said State Dispensary, and that a decree be entered ordering and directing that the amount so found to be due be immediately paid to your orator; that the defendants be required to set forth an account of all and every sum or sums of money received by them, or either of them, or which ought to have been received by them, or which has been received by any person or persons, by their or either of their orders, or for their or either of their use, from the sale of any property of the said State Dispensary, or the collection of any debt or debts due to it, and when and from whom, and from what in particular, all and every such sums were respectively received, and how the same respectively have been applied or disposed of; and that your orator have such other and further relief in the premises as the nature of the circumstances of this case may require, and as to the court may seem meet and proper.

"And may it please your honors to grant unto your orator a writ of injunction, conformable to the prayer of this bill, and also a writ of subpoena, directed to the said defendants, commanding them, and each of them, to appear and answer this bill of complaint, but not under oath, answer under oath being hereby expressly waived, and to stand to, perform, and abide by such orders, directions, and decrees in the premises as to the court shall seem meet or be required by the principles of equity and good conscience."

Return of defendants, filed January 29, 1908:

"In the Circuit Court of the United States for the District of South Carolina.

"The Fleischmann Company, Complainants, v. W. J. Murray et al., constituting the State Dispensary Commission of South Carolina, and W. J. Murray et al., Individually, Defendants. In Equity.

"Come now W. J. Murray, John McSween, B. F. Arthur, C. K. Henderson, and Avery Patton, constituting the State Dispensary Commission of South Carolina, and W. J. Murray, John McSween, B. F. Arthur, C. K. Henderson, and Avery Patton, and without submitting themselves to the jurisdiction of this honorable court, but on the contrary, insisting that it is without jurisdiction in the premises, and reserving the right to demur, plead, or answer in accordance with the rules of practice and procedure which obtain in this court, and solely in response and by way of a return to the rule to show cause, granted on the 21st day of January, 1908, 'why the relief prayed for in the said bill should not be granted and why a receiver should not be appointed by this court to take charge of and administer all of the funds now in the hands of said defendants arising from the sale of property belonging to the

State Dispensary or from the collection of any debts due it,' and for cause in this behalf these defendants say:

"(1) That the said plaintiff has not by and in said bill stated such a cause as doth or ought to entitle it to any such relief as is thereby sought or prayed for from or against these defendants, or either of them.

"(2) That it appears from the allegations contained in the complainant's bill that the said suit is a suit in fact and in legal effect against the state of South Carolina, and not against these defendants, or either of them, except as in their official capacity they represent said state, and therefore is contrary to the provisions of the eleventh amendment to the Constitution of the United States of America.

"(3) That it appears from the allegations in said bill that the said suit is a suit against the state of South Carolina, for that the purpose and intention thereof is to administer the funds and moneys belonging to the state of South Carolina and in the custody of its duly authorized agents, to coerce the state of South Carolina in the payment of the alleged debt of the plaintiff, and to restrain a duly constituted court of the state, in violation of section 720 of the Revised Statutes.

"(4) These defendants deny the allegations in paragraph 2 of the bill of complaint, and they aver that 'the manufacture, sale, barter, and exchange of intoxicating liquors was prohibited, and the state of South Carolina in the exercise of her police power engaged in and monopolized the liquor traffic, and to that end appointed and established the State Dispensary and appropriated \$50,000 for commencing said business. Said dispensary, however, had no existence or entity or credit separate and apart from the said state. It was a mere agency of the state for the conduct and operation of her business. The business belonged to the state. All purchases therefor were made by the state and upon her credit. All profits of the business and the stock on hand at the time the State Dispensary was abolished belonged to the state.

"(5) Under the act creating the State Dispensary Commission, and in the exercise of the powers, rights, and the duties conferred upon said commission and these defendants by said act, and by the act approved January 24, 1906, these defendants closed out the entire business and property of the State Dispensary, except real estate, and collected a large part of the debts, and thus the fund in controversy was realized.

"(6) These defendants deny the averments contained in paragraph 10 of the bill of complaint, and say that said funds are not trust funds, and that these defendants do not hold or control the same, as trustees, either for the complainant or other alleged creditors of the state or for any one else. They aver that said funds are in their custody or control as officers of the state and at the will of the state, and are to be disposed of in accordance with the provisions of the act creating the commission, unless said act is amended or repealed. They further aver that the said funds are the property of the state of South Carolina, and are in the possession of the said state, as the control or possession of the said funds are in the defendants as the officers of the state, and their possession or control is the possession or control of the state.

"(7) They further aver that they, as individuals, have no interest whatever in the litigation or in the funds in controversy, and that their sole duty and liability with respect to said funds is to the state of South Carolina, to her General Assembly and Governor; that the claims of the plaintiff and all others for goods sold to the State Dispensary are against the state, and not against the State Dispensary, or against the State Dispensary Commission, or against these defendants, either in their official or individual capacity. Neither the State Dispensary Commission, nor these defendants, as officers or individuals, sustain any relation or privity to the plaintiff, contractual or otherwise. They owe no duty to, and are under no liability to, the plaintiff or to any other person holding claims of like character against the state.

"(8) These defendants further say that they have exercised the powers and authority granted by the General Assembly only for the purpose of enabling them to perform their duties fairly and promptly, and they submit that they have proceeded with the work with all possible expedition and dispatch. They requested the Attorney General and his associates to investigate and secure evidence as to the validity and justice of the various claims against the state.

From time to time they impressed upon said parties their desire to complete the work as soon as possible, and repeatedly urged the necessity of prompt action. It was not until within the last 30 days, however, that said parties reported that they had secured sufficient evidence and were ready to proceed with the hearing of all said claims. These defendants say, upon information and belief, that this report was made as early as practicable, as there was a large number of claims extending over a period of several years, and the evidence relative to the same was gathered from various states. Immediately upon receipt of this report, the commission assigned 41 of said claims for a hearing, and among these was plaintiff's claim. A docket was made up, copy of which will be shown to the court, and a notice was served upon the plaintiff and upon all others whose claims had been assigned for a hearing as stated. A formal notice was served upon the plaintiff, requiring it to produce certain of its books of original entry relating to its accounts against the state.

"(9) On the 14th day of January the commission commenced the hearing of said claims. It took up the claims of Ullman & Co. and of the Anchor Distilling Company. After hearing of evidence the commission reached the conclusion that, instead of the state being indebted to said claimant in the sum of \$36,926.78, Ullman & Co. was indebted to the state in the sum of \$31,390.72, and thereupon they returned a judgment in favor of the state against Ullman & Co. in accordance with their findings. A transcript of the evidence in said case and the copy of the judgment of the commission will be exhibited to the court.

"(10) Plaintiff's claim was assigned for January 23d. George B. Lester, Esq., general counsel for plaintiff, was present on January 14th and claimed an agreement with Mr. Stevenson that plaintiff's case would be heard that day. Before announcing ready to proceed, the counsel for the state demanded the production of the books covered by the notice served upon the plaintiff as aforesaid, and notified Mr. Lester that they desired the presence of one Early, who acted for the plaintiff in connection with sales to the state, and whom they desired to examine in connection with its claim. Thereupon the said George B. Lester stated that the plaintiff would decline to produce its books or have said Early present. He challenged the jurisdiction of the commission to enter upon a full investigation of all transactions between the plaintiff and the officials of the State Dispensary, and stated that he would appeal to the federal court for relief.

"(11) The commission is advised by the Attorney General and his associates that the claim of the plaintiff for goods sold by it to the State Dispensary is unjust and invalid and they have evidence to establish: (a) That the plaintiff and the Gerson-Seligman Company are one and the same, as the latter is a mere trade-name under which the former transacted business, and was used for the purpose of avoiding the provision of the statute which prohibits any person, firm, or corporation from submitting more than one bid. (b) That there existed between the plaintiff and Gerson-Seligman Company and its agents and representatives and a majority of the said members of the board of the South Carolina Dispensary a conspiracy to defraud and cheat the state of South Carolina, and in pursuance thereof the said plaintiff, by and with the aid and assistance of the said board of directors, or a majority thereof, did cheat and defraud said state of South Carolina by charging and collecting from said state prices for the goods sold to the state which were largely in excess of the market value thereof, which overcharges were by agreement between conspirators made and used for the purpose of corrupting and bribing the officials and agents of said state of South Carolina, to the end that the board of directors of the Dispensary might be induced to purchase the goods of said plaintiff at such excess prices, and the difference between the fair market value of the goods so sold by said plaintiff to the said state and the prices at which said goods were so purchased from the plaintiff was fraudulently and unlawfully employed by the plaintiff in bribing and corrupting the officials and agents of the said state, so that said state was cheated and defrauded out of a large sum of money in excess of the amount now claimed to be due by the plaintiff. (c) That the plaintiff did not comply with the law of the state of South Carolina relative to the sale and purchase by the state board of directors, in that they failed to comply with the provisions of said

law requiring that only one bid shall be made by any one; for said plaintiff and the said Gerson-Seligman Company, being in fact one and the same firm, did fraudulently and deceitfully pretend that they were separate firms, and did frequently make two or more bids at the same time to the Treasurer of said state for consideration by the state board of directors of the South Carolina Dispensary. (d) They failed to accompany their bids, or all of them, with the chemical analysis of the liquor offered for same. (e) They failed to furnish the bonds required by law to insure the compliance by them with the terms of the contract of purchase and sale between them and the State Dispensary. (f) That they violated said law, in that they constantly had agents, representatives, and solicitors in the state for the purpose of soliciting the purchase of their goods by said state, and that through its said agents and representatives soliciting business from said board of directors. (g) That the gross amount of sales made by the plaintiff and by said Gerson-Seligman Company to the state amounted in the aggregate to several hundred thousand dollars, and that in each of the said bills there were prices charged in pursuance of said conspiracy in excess of said fair market value. (h) That the plaintiff sold to the state the same brand of liquors of a lower proof at a price higher than it sold the same brand of goods of a higher proof to other parties. (i) That the plaintiff sold to the state as whisky an artificial whisky or concoction, made of spirits with a trace of whisky added to it. (j) That in pursuance of said conspiracy the advertisements for bids were illegal, in that the prices of the liquors to be furnished were fixed in the advertisements, and thus competition was prevented. (k) That upon a just accounting between the state and the plaintiff, the plaintiff will be indebted to the state in a considerable amount.

"(12) From the evidence already before the commission it is satisfied of the existence of a conspiracy to which some of the creditors and some of the board of directors were parties, but whether the plaintiff was a party thereto, and whether its claim is valid or invalid, and whether it should be paid in whole or in part, are matters to be determined, as these defendants are advised, after the commission has heard the evidence of both plaintiff and the state.

"(13) These defendants deny each and every allegation in the bill of complaint to the effect that these defendants had stated 'that there would be no further dispute as to the amount due' plaintiff, or that these defendants had admitted that there was due the plaintiff a balance of \$66,501.19, or any other amount, or that they had agreed to pay plaintiff any amount whatever, or that 'the amount due [plaintiff] had been determined and agreed upon,' or 'that the amount claimed by [plaintiff] has been admitted by the defendants to be a just liability against the State Dispensary and now due and payable out of the fund in their hands,' or that 'the said defendants have never claimed or pretended that said amount was subject to any offsets, credits, or counterclaims.' Each and every of said averments are untrue.

"(14) Defendants deny the averment in said bill of complaint to the effect that plaintiff's account has been 'adjusted,' except to the extent that the books of the State Dispensary have been audited and the entries thereon have been brought into substantial agreement with the items of plaintiff's claim. There has been no determination or adjustment as to whether the items on said claim are proper and just charges against the state, nor whether the said claim is to be reduced in whole or in part by reason of offsets and counterclaims, nor whether said claim or any part thereof is illegal by reason of a noncompliance with the statutes of South Carolina, or by reason of frauds and conspiracies to which the claimant was a party, and, in short, for any of the reasons which the Attorney General and his associates contend they can establish by the evidence to which reference has been made. Moreover, defendants are advised that until final judgment all tentative conclusions or decisions, however solemnly announced, were subject to modification or reversal.

"(15) These defendants denounce as gratuitously false the charges in said bill of complaint 'that there has been formed and now exists an unlawful understanding or agreement between the defendants by which it has been decided that the money deposited in the banks above named shall be held and allowed to remain as long as possible in said banks, to be used by them for

their own benefit and profit,' and that the defendants 'are wrongfully and unlawfully retaining said money for the use and benefit of the institution in which they are personally interested, and are wrongfully and unlawfully refusing to carry out and perform the duties in trust imposed upon them.' The defendants aver that they deposited the funds received by them in 31 banks in the state of South Carolina, in which there is now on deposit to the credit of the State Dispensary Commission the aggregate sum of \$706,599.82 on call and subject to check; that each and every of the said banks is sound and of undoubted solvency; that each and every of said deposits, with the exception of \$16,505.59 on deposit with the National Loan & Exchange Bank as an active account, draw interest from the date the deposits were respectively made at 4 per cent. per annum, and are secured by state and municipal bonds and other solvent securities deposited by said banks with said commission as collateral security for the payment of principal and interest of said respective deposits, the market value of which is largely in excess of the deposits secured thereby. The defendants will exhibit to the court a list of the said banks with the amount deposited in each.

"(16) That in addition to said amounts deposited and secured as aforesaid the commission will hereafter receive about \$100,000 on account debts due by various county dispensaries, which, when received, will in like manner be deposited and secured.

"(17) The defendants admit that some of them are stockholders and directors in some of the banks named, but they submit that each of the said banks was selected solely because of its recognized solvency and its willingness to secure the deposits with sufficient and satisfactory collaterals and to pay 4 per cent. interest thereon.

"(18) The commission offered \$150,000 to the Carolina National Bank and the Bank of Columbia, both of which refused to collaterally secure the deposit, and for that reason the deposits were not made with them. The defendants are informed and believe that they could not have found banks, either in or out of the state of South Carolina, in which to deposit said fund, which would have received said deposits on safer or more favorable terms.

"(19) The defendants deny the allegations in paragraph 14, and aver that there is no difference between the members of the commission as to the method to be pursued in dealing with the creditors of the state for goods sold to the State Dispensary, and that the commission as a body is a unit on the following propositions, to wit: (1) To require all creditors whose claims are challenged by the counsel for the state to produce their books of original entry and their documents containing material evidence and to comply with all reasonable and proper requirements prescribed by the commission. (2) To hear all competent evidence presented by the creditors or by counsel for the state, and after a careful and judicial consideration thereof to determine what amounts are due by the state, and pay all claims which in their honest and impartial judgment are due by the state, and no others.

"(20) The defendants deny that it has been eight months since Commissioner Arthur has met with the commission. It is true that he has not attended the meetings of said commission since November. His physician wrote the commission that Mr. Arthur's absence from one or more of the meetings was because of his illness.

"(21) These defendants deny the allegations contained in paragraph 15 of the bill of complaint, and they denounce as gratuitously false and malicious the allegations in said paragraph that 'the defendants have entered into an unlawful combination or conspiracy with one J. Fraser Lyon, the present Attorney General of the state of South Carolina, and under whose advice said defendants are acting to aid the said Lyon in carrying out his frequent threats to prosecute and imprison said officers and to that end have agreed among themselves and with said Lyon to withhold the payment of the claim of your orator and all other creditors until the said Lyon has obtained such evidence as may be sufficient to prove the guilt and secure the conviction of said officers; that under and pursuant to this agreement, combination, or conspiracy the defendants have refused and are still refusing to carry out the provisions of the act of 1907.' The defendants aver that they withheld payment until the state could have an opportunity to collect the evidence with regard to said

claims, and after a regular and orderly hearing the commission could reach a fair decision as to the validity and justice of the various claims.

"(21a) It is further averred that after the hearing of the case of Ullman & Co. on the 15th day of January, 1908, the commission and the counsel for the state were then and there ready to hear and determine the other cases assigned in their regular order, but said cases were not heard because of the absence of some of the claimants and because of the failure of others to comply with the reasonable orders of the commission. Thereupon the commission assigned all of the remaining cases for hearing to be commenced on January 30th, and to continue from day to day until all of said cases have been finally disposed of. It is the purpose of said commission to hear and decide the cases in their order upon the calendar, and notices to this effect were sent the various claimants by registered mail, and unless prevented by the orders of this honorable court the commissioners will execute said purpose, and will pay each and every claim which shall be determined to be due and owing by the state.

"(22) It is further averred that the state is the owner of said funds, and should be sole defendant; at least, the state is an indispensable and necessary party. Defendants are advised that the state is not subject to suit, and cannot be the sole defendant, or the defendant at all, and that therefore the court is without jurisdiction; but they submit that, if it had jurisdiction, there is no necessity for the appointment of a receiver. The state authorized the commission to act in the premises, and these defendants have undertaken to discharge their duties fairly, promptly, and conscientiously. They submit that all the allegations and insinuations made in the bill of complaint charging neglect, delay, or improper or fraudulent conduct on the part of these defendants are unfounded and false, and they submit that they should be permitted to complete the work and discharge the responsibilities imposed upon them by the state.

"(23) These defendants demand strict proof of each and every allegation in the bill of complaint contained, except those herein specifically admitted to be true.

"(24) The defendants submit herewith a number of affidavits, and they pray that the same may be taken in connection with and as a part of their return; and, having fully answered, they pray to be hence discharged, with their reasonable costs in this behalf expended."

Upon the filing of the bill an order was issued by the Circuit Court of the United States for the District of South Carolina, requiring the respondents, to wit, the five dispensary commissioners heretofore named, to appear and show cause why a receiver should not be appointed and an injunction granted as prayed for by the complainants. On the return and answer of the said commissioners, and after a hearing, receivers were named by the Circuit Court to take charge of the fund in the hands of the respondents, and an injunction was also granted restraining said respondents from disposing of the funds in their hands, etc. From these decrees and orders, which were made in vacation, the respondents appealed to this court.

The positions relied upon chiefly by the appellants are that the Circuit Court is without jurisdiction in this case; and the basis of the position is that the suit is one against the state of South Carolina, and is prohibited by the eleventh amendment; that the dispensary was a state institution, and its operation part and parcel of the exercise of independent power by a sovereign state; that the present commissioners are officers of the state, and that the fund in their hands belongs to the state and, therefore, the state is not only a necessary, but an indispensable, party to any suit or judicial proceeding seeking the fund or any part of it; that the Dispensary Commission is a court of the state of South Carolina, and that the Circuit Court is forbidden by law to enjoin its proceedings; and, further, that the equities alleged in the bill are not sufficient to authorize an injunction and the appointment of receivers as prayed for. On the other hand, the appellees insist that the commissioners (appellants) are mere ministerial agents appointed under the provisions of the act of the South Carolina Legislature to dispose of the dispensary property, collect the debts due, and from the funds thus arising to

first pay off and discharge the just liabilities incurred in the operation of the dispensary in the purchase of supplies, etc., and the residue, if any, to pay to the state; that the fund in the hands of the appellants was there, by virtue of the law, for special purposes, the first of which was to pay the dispensary debts; and that the state has no interest save in the residue, if there be such, after the just debts are paid. In other words, the position principally maintained by the appellees is that the appellants, as commissioners acting under the authority of the act of the South Carolina Legislature, became and are trustees of a special fund, which they hold primarily for the specific purpose of paying the debts which had been incurred by the dispensary in the course of its operations; that the action of the appellants in refusing to adjust and pay the claims of the appellees was an abuse of trust, and was an arbitrary and illegal attempt to defeat complainants of their rights. The appellees say, therefore, that they sought relief in a court of equity, there being, under the circumstances, no adequate remedy at law, whereby they might have the just and true amounts of their claims ascertained and have the funds in the hands of the appellants applied in payment, as contemplated by the provisions of the law which created the commissioners and from which they derived their power to act.

B. L. Abney, W. F. Stevenson, and D. W. Rountree (Anderson, Felder, Rountree & Wilson, Abney & Muller, Stevenson & Matheson, and J. Fraser Lyon, on the briefs), for appellants.

T. Moultrie Mordecai, Alfred S. Barnard, and Simeon Hyde (Frank Carter, H. C. Chedester, and Geo. B. Lester, on the briefs), for appellees.

Before FULLER, Circuit Justice, and WADDILL and BOYD, District Judges.

BOYD, District Judge (after stating the facts as above). When we have cleared away the immaterial matter and have divested this controversy of all save that which relates to the substance of it, there remains to be considered two main propositions. The first is jurisdictional, and presents the question whether this action is against the state of South Carolina, and, therefore, forbidden by the eleventh amendment to the Constitution of the United States; the second, whether the Dispensary Commission, against the several members of which this suit is brought, is a court of the state of South Carolina and, therefore, incapable of having its proceedings stayed by writ of injunction granted by a court of the United States. Section 720, Rev. St. (U. S. Comp. St. 1901, p. 581). To these two may be added another, which relates particularly to the bill and the testimony offered by the complainant in support; the appellants having set up, as a part of their answer, that the bill and the testimony are insufficient to authorize an injunction and the appointment of receivers pendente lite. The principles involved in the first proposition, however, are paramount; and following closely, as affecting the right of the complainant to maintain this action and the jurisdiction of the court to entertain it, is the second proposition.

Is this a suit against the state of South Carolina, or is the purpose of the action and the disposition sought to be made of the subject-matter of such nature as to render the state an indispensable party? In other words, does the state hold the money which the complainant

undertakes to subject to the payment of his debt in its sovereign capacity, as a part of its public fund for its use in supporting and carrying on the state government? Undoubtedly the eleventh amendment was intended to prevent a federal court, in suits prosecuted by citizens of another state or citizens or subjects of a foreign state, from interfering with a state in the preservation of its autonomy, in maintaining its own system of self-government, so long as such system is in harmony with the Constitution of the United States. To this end, therefore, the funds of the state, in its treasury, or held by its officers or agents, for use in the administration of the governmental affairs of the state, are not to be affected by the process of a federal court; nor can such court entertain jurisdiction of an action which has for its purpose the invasion of the right of the state to manage and control its internal affairs, or of an action which will obstruct the state authority or impair the state instrumentalities in the discharge of legitimate functions in the maintenance of the state's integrity. To be more concise, the constitutional inhibition is to the effect that the courts of the United States cannot entertain jurisdiction in an action at the instance of a citizen which seeks to recover as against the state the property belonging to the state, or the purpose of which is, and the result of which would be, to disturb the legal and orderly administration of the state's internal governmental affairs by its duly appointed officers and agents.

Does this case come within the limits prescribed? In this connection it becomes necessary to inquire if the state has any present interest in the fund in controversy, which can be divested by a judicial determination of the true amount, if any, justly due the complainant. Or has the state by an act of the Legislature relinquished all right, if any existed, to enough of the fund to pay all the just debts contracted by the dispensary authorities? If so, can the ascertainment of the true amount of these debts and the application of the funds in the hands of the commissioners in payment affect the right of the state, or in any way interfere with the authority of the state, to manage and control its internal government within the bounds of its legitimate autonomy?

The first proposition presented to us rests largely upon the construction to be given to the act of the South Carolina Legislature, approved February 16, 1907. Sess. Laws 1907, p. 835. This act provides that:

"The Governor shall appoint a commission of well-known business men of five members, * * * to be known as the State Dispensary Commission."

"Said commission shall immediately organize by the election of a chairman and a secretary from their number."

"It shall be the duty of said commission to close out the entire business and property of the State Dispensary, except real estate, including stock in the several county dispensaries, by disposing of all goods and property connected therewith, by collecting all debts due and by paying from the proceeds thereof all just liabilities at the earliest date practicable."

By section 47 of another act passed by the South Carolina Legislature on the 16th of February, 1907 (Sess. Laws 1907, p. 480), the

dispensary as a state institution was abolished; the enactment to that end being as follows:

"The State Dispensary is hereby abolished and all acts or parts of acts inconsistent with this act are hereby repealed."

Then came the other act of February 16, 1907, creating the commission and from which we have quoted above. This act bears the title:

"An act to provide for the disposition of all property connected with the State Dispensary and to wind up its affairs."

Thus we see that the state determined to go out of the business of dealing in liquors, and through its Legislature repealed the law under which it had operated, and by another act assigned all of the property, estate, and effects belonging to or connected with the dispensary to the Dispensary Commission, to be reduced to cash and from the proceeds first to pay all just liabilities. From this source the fund now in the hands of the commission arose. The state, through its Legislature, has passed both the title and possession of the fund involved to the commission for the purposes designated in the act, the first of which is to pay all outstanding just liabilities which had been incurred by the State Dispensary in the course of its operations. The fund being in the hands of the commission charged with this duty, the state has no interest in so much thereof as is necessary to pay the just debts. Then how can it infringe any right of the state to have the true amount of the debts due by the defunct dispensary judicially ascertained?

In *Bank of United States v. Planters' Bank of Georgia*, 9 Wheat. 904, 6 L. Ed. 244, which was a suit brought in the Circuit Court of the United States, the question of jurisdiction, in view of the eleventh amendment to the Constitution, is discussed. The action was founded on promissory notes payable to a person named therein, and were duly transferred, assigned, and delivered to the plaintiff. A plea was entered by the defendant to the jurisdiction of the court on the ground that it was a corporation in which the state of Georgia, and certain individuals, who were citizens of the same state, were stockholders, and the point made by the defendant was that, the state of Georgia being a stockholder, the action was forbidden by the eleventh amendment. In delivering the opinion Chief Justice Marshall uses this language:

"This suit is not to be sustained because the Planters' Bank is suable in the federal courts, but because the plaintiff has a right to sue any defendant in that court who is not withdrawn from its jurisdiction by the Constitution or by law. The suit is against a corporation, and the judgment is to be satisfied by the property of the corporation, and not by that of the individual corporators. The state does not, by becoming a corporator, identify itself with the corporation. The Planters' Bank of Georgia is not the state of Georgia, although the state holds an interest in it. It is, we think, a sound principle that when a government becomes a partner in any trading company it divests itself, so far as concerns the transactions of that company, of its sovereign character, and takes that of a private citizen. Instead of communicating to the company its privileges and prerogatives, it descends to the level of those with whom it associates itself, and takes the character which belongs to its associates and to the business which is to be transacted."

In the case of *Governor of Georgia v. Madrazo*, 1 Pet. 110, 7 L. Ed. 73, in the course of an opinion delivered by Chief Justice Marshall, it is said:

"In *United States v. Peters* [3 Dall. 121, 1 L. Ed. 535] the court laid down the principle that, although the claims of a state may be ultimately affected by the decision of a cause, yet if the state be not necessarily a defendant, the courts of the United States are bound to exercise jurisdiction."

In the case of *Pennoyer v. McConnaughy*, reported in 140 U. S. 1, 11 Sup. Ct. 699, 35 L. Ed. 363, very clearly drawn is the distinction, in suits brought against officers or agents of a state, as to when the jurisdiction of the Circuit Courts of the United States may be maintained and when such jurisdiction cannot. In the course of the opinion in this case the court, speaking through Mr. Justice Lamar, says:

"The first class is where the suit is brought against the officers of the state as representing the state's action and liability, thus making it, though not a party to the record, the real party against which the judgment will so operate as to compel it to specifically perform its contract."

Suits within this class are forbidden. The court further says:

"The other class is where the suit is brought against defendants who, claiming to act as officers of the state and under the color of an unconstitutional statute, committed acts of wrong and injury to the rights and property of the plaintiff acquired under a contract with the state. Such suit whether brought to recover money or property in the hands of such defendants unlawfully taken by them in behalf of the state, or for compensation in damages, or in a proper case where the remedy at law is inadequate for an injunction to prevent such wrong and injury, or for a mandamus in a like case to enforce upon the defendant the performance of a plain, legal duty, purely ministerial, is not, within the meaning of the eleventh amendment, an action against the state."

Suits within this class are not forbidden.

In the case of *Swasey v. N. C. Railroad Company*, 23 Fed. Cas. 518 (No. 13,679), the state of North Carolina had issued bonds for the construction of the North Carolina Railroad. The state took stock in the North Carolina Railroad Company to the amount of the construction bonds so issued. The act under which the bonds were issued pledged the stock which the state held in the company for the payment of the bonds. The bondholders brought a suit in the Circuit Court of the United States for the District of North Carolina, seeking to subject the stock to the payment of overdue bonds and also accumulated interest. It was contended that the state of North Carolina was an indispensable party to this suit on account of its interest in the result, and that, therefore, the suit was forbidden by the eleventh amendment; but the court said:

"If a state could be brought into court, it undoubtedly should be made a party before a decree is rendered; but since the case of *Osborne v. Bank*, 9 Wheat. 739, 6 L. Ed. 204, it has been the uniform practice of the courts of the United States to take jurisdiction of cases affecting the property of a state in the hands of its agents without making the state a party, when the property or the agent is within the jurisdiction. In such case the court acts through the instrumentality of the property or the agent."

Another case following in the same line is that of *Chaffraix v. Board of Liquidation et al.* (C. C.) 11 Fed. 638, in which it is held that:

"The Circuit Court has jurisdiction to prevent by injunction the officers of a state from diverting a fund collected by taxation and set apart under a statute of that state to pay certain bonded indebtedness of said state, to the end that said fund may be preserved intact until the rights of the parties and interests of the state, if any she has, may be determined contradictorily. Such action is not forbidden by the eleventh amendment to the Constitution of the United States, and is necessary for the proper enforcement of section 10 of article 1 of the same instrument."

In the case of *Tindal v. Wesley*, reported in 167 U. S. 204, 17 Sup. Ct. 770, 42 L. Ed. 137, the Supreme Court further emphasizes the distinction we are discussing. That was a suit by citizens of New York against citizens of South Carolina to recover the possession of certain real property in the latter state, with damages for withholding possession. One of the defendants in his answer stated that he had no personal interest in the property, but as Secretary of State of South Carolina had custody of it and was in possession only in that capacity. The other defendant stated that he was watching, guarding, and taking care of the property under employment by his co-defendant. Both defendants disclaimed any personal interest in the property, and averred that the title and right of possession was in the state. It was held in that case, Mr. Justice Harlan delivering the opinion of the court:

"That the suit was not one against the state within the meaning of the eleventh amendment to the Constitution of the United States."

And it was held, further:

"That a suit against individuals to recover the possession of real property is not a suit against the state simply because the defendant holding possession happens to be an officer of the state and asserts that he is lawfully in possession on its behalf. The eleventh amendment gives no immunity to officers or agents of a state in withholding the property of citizens without authority of law," etc.

Further in this decision the court says:

"Of course, it was competent for the defendants to prove that the lots in question belonged to the state, and in that way defeat the present action. So it would have been competent for the state, if it claimed the property, to have intervened and submitted to the jurisdiction of the court, to have obtained a judicial determination of the claim asserted for it by the defendants. But it did not intervene. It refused to do so."

The court goes still further, and refers to the case of *South Carolina v. Wesley*, 155 U. S. 542, 15 Sup. Ct. 230, 39 L. Ed. 254, stating:

"It appears that the state, by its Attorney General, suggested to the court that these lands were held, occupied, and possessed by the state through and by its officer and agent, and were used for public purpose; and without submitting the rights of the state to the jurisdiction of the court, but respectfully insisting that the court has no jurisdiction of the subject in controversy, it moved that the proceedings be dismissed. That motion was overruled, and the writ of error sued out by the state was dismissed; the Chief Justice observing: 'The state does not complain that it was refused leave to intervene, but that the Circuit Court, without the intervention of the state, refused mere-

ly upon suggestion to dismiss the complaint against the defendants who were sued as individuals. The state was not a party to the record in the Circuit Court, and did not become a party by intervention pro inter esse suo or otherwise, but expressly refused to submit its rights to the jurisdiction of the court.'"

U. S. v. Lee, 106 U. S. 196, 1 Sup. Ct. 240, 27 L. Ed. 171 and Georgia v. Jesup, 106 U. S. 458, 1 Sup. Ct. 363, 27 L. Ed. 316, are also cited.

It will be found that the doctrine declared in the several cases, as above recited, is reiterated in the case of Gunter, Attorney General, etc., v. Atlantic Coast Line, 200 U. S. 273, 26 Sup. Ct. 252, 50 L. Ed. 477.

But we deem it unnecessary to cite further authorities upon the position we are presenting, for upon examination of the cases we have mentioned it will be found that other cases bearing upon the point are referred to. We will, however, call attention to the most recent case involving the principle, and that is in the matter of Edward T. Young, petitioner on petition for writ of habeas corpus and certiorari, decided during the last term of the Supreme Court. 209 U. S. 123, 28 Sup. Ct. 441, 52 L. Ed. 714, 13 L. R. A. (N. S.) 932. This case arose in the state of Minnesota and was a suit in equity brought by a certain railway company to restrain the Attorney General and other officers of the state from enforcing a law which had been passed by the Minnesota Legislature imposing penalties upon railroad corporations and officers of such corporations for violating freight rates provided under the state law. The Attorney General of the state of Minnesota, who is the petitioner in the case, relied upon the position that the proceeding by the railroad was a suit against the state and forbidden by the eleventh amendment. The Supreme Court, Mr. Justice Peckham delivering the opinion, held that, as the act of the Legislature in question was unconstitutional, the Attorney General and other officers of the state who undertook to enforce it to the injury of the railroad were not protected by the eleventh amendment; that the suit was not one against the state, but against the Attorney General and other officers named, to restrain them from enforcing an unconstitutional act of the Legislature.

In what capacity, therefore, are the members of the commission acting? Are they officers of the state of South Carolina, discharging a duty in behalf of the state, or are they agents appointed under the act of the Legislature of the State, empowered to take possession of a certain fund and directed to administer such fund in a particular manner? In other words, does the act creating the commission and authorizing the appointment of the several members who compose it confer upon them any powers in connection with the administration of the state's affairs, or are they by the terms of the act holders of a special fund intrusted to them for the prime purpose of paying off and discharging the State Dispensary debts? We are constrained to hold that the fund in their hands is, by virtue of the provisions of the act, held in trust for the payment of the debts mentioned, and that the creditors of the State Dispensary have a property in the fund in the hands of the commission, to the extent that the debts are shown

to be just, and that a judicial determination of the true amount of such debts can in no way affect the rights or interests of the state; the only interest of the state in the fund being, as declared by the act, the residue after the just liabilities of the State Dispensary are paid, and this interest is subordinate to the payment of the said liabilities. It is elementary that particular formality is not required in the creation of a trust. If any agreement or contract in writing is executed by one having the power to dispose of property, whereby it is directed that particular property or fund shall be held or dealt with for a special purpose for the benefit of another, in such case equity raises a trust in favor of the beneficiary. The right to create a trust for specific purposes is not confined to individuals or private parties; but we find in Perry on Trusts, § 30:

"That a state, by its legislation, or by its public officers, duly authorized, can create a trust, convey property, and appoint trustees."

The provisions of the act creating the Dispensary Commission are strikingly similar in substance to the usual form of conveyances of property in trust for the benefit of creditors. There are the necessary three parties—the trustor, the trustees, and the cestui que trusts. The state, acting through the Legislature, passes the title and possession of certain property to the five appellants, who are constituted a Dispensary Commission. The direction is that the appellants take this property, sell it, collect debts, and, when the proceeds are in hand, pay off the just liabilities of the State Dispensary. The act then provides for the payment of certain expenses incident to the discharge of the duties devolving upon the commission, and after that the residue to be paid to the state. We undertake to say that there is scarcely to be found recorded anywhere an assignment by a debtor for the benefit of creditors more intelligently constructed or more readily understood. Having, therefore, determined the relation of the appellants to the fund in controversy, we answer the question propounded in the outset that this is not a suit against the state and that complainant is not forbidden to maintain his action by the eleventh amendment to the Constitution of the United States. The appellants are in possession of the fund which complainant is seeking to recover on the ground that it has been set apart and placed in the hands of the appellants to pay a debt which is justly due him. The state of South Carolina does not intervene to assert any right to this fund or to have any interest which the state may have in it determined; but the appellants themselves raise the question of the jurisdiction of the court, basing it upon the allegation that the property in their hands belongs to the state. We think, in view of the facts in this case, upon the authorities heretofore cited, and especially under the case of *Tindal v. Wesley*, supra, the appellants are not entitled to avail themselves of that defense.

This suit is not against the state, nor is the state an indispensable party. Treating the fund in the hands of the appellants as a trust fund, and the duties of the trustees in regard thereto being clearly defined, the trustor is not even a necessary party to the suit brought to compel the trustees to discharge their said duties. However, if the

state elects, it may intervene and have a judicial determination as to any right it may claim. To conclude, therefore, as to the first proposition, it is our opinion that the Circuit Court has jurisdiction of this case and that the same is cognizable in a court of equity. It is the peculiar province of courts of equity to administer trusts. Indeed, it is a familiar saying that "equity loves a trust," and that it will not permit a trust to fail for the want of a trustee. In a court of equity, which is a forum of conscience, the shortcomings of the law can be supplied, and every interest and right can be protected and administered, so as to insure exact justice. The proceedings in these courts are of such character as to be most conducive to the ascertainment of truth, and, besides this, a chancellor may, if he deems it expedient, be aided in determining a difficult issue of fact by calling to his assistance a jury on the law side of the docket.

It is insisted that the claims involved in this controversy, if due, are debts of the state, and appellants say that they represent the state, which is the real party in interest; yet in this situation they contend that, in case of a dispute as to the validity of any of the claims, it should be left to them to decide. In other words, their position appears to be that the agents and representatives of the debtor should constitute a tribunal, absolute in its character, to arbitrarily pass upon what, if anything, is due an alleged creditor, and if a claim be adjudged invalid to put an end to it, without further opportunity for redress on the part of the creditor. To uphold such contention would, in our opinion, in the event that a just debt due a creditor was thus rejected, deprive such creditor of his property without due process of law.

This case presents itself in another aspect, which, to say the least, is somewhat novel, and which, if other attending conditions were different, might affect the right of the state to avail itself of the provisions of the eleventh amendment. We feel justified in assuming that in the conception and adoption of the eleventh amendment it never entered the mind that a sovereign state would engage in business as a liquor dealer and become a trader by buying and selling an article of common traffic in competition with the citizens of the country. It may be questioned, therefore, whether the state of South Carolina, in becoming such dealer, was exercising a governmental prerogative or performing a function necessarily or properly incident to its autonomy as a state. It is not our purpose to venture an opinion in respect to this question, for, in view of what we have said before, it is not necessary to the disposition of the case, and then we have no authority in point to guide us. We will, however, recall, as having some bearing on the question, the following quotation from *Bank of United States v. Planters' Bank of Georgia*, supra:

"It is, we think, a sound principle that, when a government becomes a partner in any trading company, it divests itself, so far as concerns the transactions of that company, of its sovereign character, and takes that of a private citizen."

And we may also refer to *South Carolina v. United States*, 199 U. S. 437, 26 Sup. Ct. 110, 50 L. Ed. 261. In this case the Supreme

Court passed upon the right of the United States government to require the South Carolina dispensaries to pay the privilege tax as liquor dealers. The contention was there, as here, that the dispensary was a state institution, and, therefore, not subject to tax by the federal government. Mr. Justice Brewer, after citing a number of cases, in the course of the opinion which he delivered for the court, uses this language :

"These decisions, while not controlling the question before us, indicate that the thought has been that the exemption of state agencies and instrumentalities from national taxation is limited to those which are of a strictly governmental character and does not extend to those which are used by the state in the carrying on of an ordinary private business."

These declarations by the highest court of the nation will at once suggest the inquiry, if the dispensary was not an instrumentality of the state's government in one respect, can it be such in any other?

The second proposition is whether the State Dispensary Commission, provided for in the act of February 16, 1907, is a court of the state of South Carolina, and, therefore, cannot be enjoined because of the provisions of section 720 of the Revised Statutes of the United States. We scarcely deem it necessary to enter into an elaborate discussion of this question, for what is said by us before practically disposes of it. However, a perusal of the act creating the commission will at once repel the argument that it is, in any sense, a court. The Constitution of South Carolina provides for courts as follows: First, a court for the trial of impeachments; second, a Supreme Court; third, a court of common pleas and general sessions; fourth, a probate court; fifth, courts of magistrates; and, sixth, such other inferior courts as the General Assembly may, from time to time, in their wisdom establish. There is nothing in the act creating the commission which suggests that the Legislature contemplated that it was to be a court. It is certainly not one of the courts provided for by the Constitution, as above set forth; nor does the act declare that it is a court of an inferior character. No method of procedure is provided, such as is usual in a court. The commission has no power to enter a judgment or enforce any mandate by process. It is true that by virtue of the act the commissioners are authorized to investigate transactions connected with the management and control of the State Dispensary anterior to the time that it was abolished, and to ascertain if there had been fraudulent practices on the part of the dispensary agencies in connection with the purchases of liquors, and report their actings and doings to the Governor; but they were not empowered by the act to determine any issue of fact, enter any judgment, or conclude any party that might be investigated as to any right or interest involved. The only element of discretion given to the commissioners which we can find at all in the act is in section 3, where, after providing that the commissioners shall sell the property and collect the debts, and pay from the proceeds thereof all just liabilities, etc., there is the following :

"Said commission shall be at liberty to make such disposition upon such terms, times and conditions as their judgment may dictate."

This can be construed to refer only to sales of the property. In every other respect the duties which devolve upon the commissioners are purely ministerial. It is our opinion, therefore, that the contention that the Dispensary Commission is a court is not well founded.

The proposition that complainant's bill and the testimony in support of it are insufficient to authorize a decree for injunction and receivers *pendente lite* can be readily disposed of. The bill alleges a just debt still existing and unpaid for liquors sold to the dispensary authorities by complainant. It is further alleged that said debt has been audited by the agency employed by the appellants, and has been found to correspond with the entries upon the books kept by the State Dispensary board, and, further, that the appellants refuse to pay complainant's debt from the funds in their hands set apart for that purpose. If these allegations are true, the complainant has the right to invoke the aid of the court. The appellants, in their return to the order to show cause, in paragraph 11, substantially deny the validity of the complainant's debt in the following language:

"The commission is advised by the Attorney General and his associates that the claim of the plaintiff for goods sold by it to the State Dispensary is unjust and invalid, which they have evidence to establish."

This is a practical admission that the appellants did not intend to pay complainant's debt from the fund in their hands. His only recourse, therefore, was by an appeal to a court of competent jurisdiction to determine as to whether or not his debt was just, and, if so, to require the appellants to pay it from the fund in their hands for that declared purpose, and also to have the fund preserved to that end. So we dismiss that part of the case without further consideration.

Since the commencement of this action and the decision of the Circuit Court of the United States for the District of South Carolina that it had jurisdiction, and the issuing of an injunction and appointment of receivers as prayed for in complainant's bill, the Supreme Court of South Carolina, in a case brought before it, has rendered a decision construing the South Carolina statute involved in this controversy, and holds that a suit against the Dispensary Commission (the appellants in this case) is a suit against the state of South Carolina, and, therefore, forbidden by the eleventh amendment. The South Carolina Supreme Court is entitled to, and has, our most profound respect; but under the circumstances we do not feel at liberty to adopt the construction given by that tribunal to the South Carolina statute after the rights of complainant have accrued, and after he has sought his remedy in a Circuit Court of the United States, which has given a construction to the statute contrary to the decision subsequently rendered by the Supreme Court of the state. The law governing us is well settled in the case of *Burgess v. Seligman*, 107 U. S. 33, 2 Sup. Ct. 10, 27 L. Ed. 359, in which it is held:

"We do not consider ourselves bound to follow the decision of the state court in this case. When the transactions in controversy occurred, and when the case was under the consideration of the Circuit Court, no construction of the statute had been given by the state tribunals contrary to that given by the Circuit Court. The federal courts have an independent jurisdiction in the administration of state laws, co-ordinate with, and not subordinate to, that

of the State courts, and are bound to exercise their own judgment as to the meaning and effect of those laws. The existence of two co-ordinate jurisdictions in the same territory is peculiar, and the results would be anomalous and inconvenient, but for the exercise of mutual respect and deference. Since the ordinary administration of the law is carried on by the state courts, it necessarily happens that by the course of their decisions certain rules are established, which become rules of property and action in the state and have all the effect of law, and which it would be wrong to disturb. This is especially true with regard to the law of real estate and the construction of state Constitutions and statutes. Such established rules are always regarded by the federal courts, no less than by the state courts themselves, as authoritative declarations of what the law is. But, where the law has not been thus settled, it is the right and duty of the federal courts to exercise their own judgment, as they always do in reference to the doctrines of commercial law and general jurisprudence. So, when contracts and transactions have been entered into and rights have accrued thereon under a particular state of the decisions, or when there has been no decision, of the state tribunals, the federal courts properly claim the right to adopt their own interpretation of the law applicable to the case, although a different interpretation may be adopted by the state courts after such rights have accrued."

And in the case of *Pease v. Peck*, 18 How. 595, 15 L. Ed. 518, we find the following principle laid down:

"When the decisions of the state court are not consistent we do not feel bound to follow the last, if it is contrary to our own convictions; and much more is this the case where, after a long course of consistent decisions, some new light suddenly springs up, or an excited public opinion has elicited new doctrines, subversive of former safe precedent. Cases may exist, also, when a cause is got up in a state court for the very purpose of anticipating our decision of a question known to be pending in this court. Nor do we feel bound in any case in which a point is first raised in the courts of the United States, and has been decided in a Circuit Court, to reverse that decision contrary to our own convictions, in order to conform to a state decision made in the meantime. Such decisions have not the character of established precedent declarative of the settled law of a state."

It is our conclusion, therefore, that the decree of the Circuit Court for the District of South Carolina, appealed from, should be affirmed. The case will be remanded, to be further proceeded with in accordance with the views herein expressed.

Affirmed.

BAGLIN et al. v. CUSENIER CO.

(Circuit Court of Appeals, Second Circuit. August 3, 1908.)

No. 230.

**TRADE-MARKS AND TRADE-NAMES — INFRINGEMENT—UNFAIR COMPETITION—IN-
JUNCTION.**

For many years the order of Carthusian Monks established at La Grande Chartreuse, in France, made and sold a liqueur, claimed to have been made by a secret process, which became widely known as "Chartreuse" throughout the United States, where such name is also registered as a trade-mark. The order having been expelled from France by the government, its entire property, including its distillery, products, good will, and trade-marks, were sold to defendant by a receiver under an order of the courts, and defendant, although having no knowledge

of the secret formula, commenced the manufacture of a similar liqueur, which it sold under the same name, using the same bottles formerly used by the monks and the same labels, which contained a signature and certain symbols peculiar to the order. In the meantime the monks established a factory at Tarragona, Spain, where they continued to make and sell the liqueur in accordance with the original formula, using, however, a different label and style of package. *Held*, that the action of the French government and courts did not vest defendant with the right to use the name and labels of the monks in the United States, and, while it had the right to state on its labels the place where its liqueur was made, it would be enjoined from doing so without accompanying words stating the facts and clearly distinguishing its liqueur from that manufactured by the monks, and from imitating the original labels in such manner as to mislead purchasers.

Noyes, Circuit Judge, dissenting.

Appeal from the Circuit Court of the United States for the Southern District of New York.

See 156 Fed. 1019.

The Circuit Court adjudged: (1) That the word symbol "Chartreuse," as applied to liqueur, is a good and valid trade-mark in this country and has been and now is the sole and exclusive property of the Carthusian Monks, who are the complainants herein, and that the label as set forth in the United States trade-mark certificate No. 3,377 constitutes a valid trade-mark in this country. (2) That the defendant has been guilty of unfair competition and has infringed said trade-mark by importing into this country liqueur not made by the complainants but bearing the said labels and trade-marks. (3) That the defendant be perpetually enjoined from using in this country, or in any possession thereof, in connection with any liqueur not manufactured by the complainants, the trade-mark, "Chartreuse" or the fac simile signature "L. Garnier" or any of the trade-marks above referred to. (4) That the usual accounting of defendant's profits be had.

A preliminary injunction granted by the Circuit Court (156 Fed. 1015) was modified by this court (141 Fed. 497, 72 C. C. A. 555). The opinion below is reported in 156 Fed. 1016.

See, also, *Bauer & Co. v. Carthusian Monks*, 120 Fed. 78, 56 C. C. A. 480.

A. L. Pincoffs, Hubert Howson, and Charles Howson, for appellant.
Philip Mauro, C. A. L. Massie, and Ralph L. Scott, for appellees.

Before COXE, WARD, and NOYES, Circuit Judges.

COXE, Circuit Judge (after stating the facts as above). The principal facts are found in the prior opinions, *supra*, and need not be repeated. We think, however, that the statement of the circumstances which resulted in the complainants leaving France and setting up their distillery at Tarragona, Spain, requires some additional recital of the facts. The defendant, at the time the answer was filed, was the agent in the United States of the receiver of the complainants'

property, appointed by the French courts. Whatever title the receiver acquired the defendant acquired, whatever rights the receiver had the defendant has. The same is, of course, true of the present owner, the Compagnie Fermière de la Grande Chartreuse.

On July 2, 1901, the French associations law was promulgated. With the intent and purpose of this measure we have nothing to do. The lawmakers deemed it necessary for the perpetuity of the Republic and it has been upheld and enforced by the courts of France. Pursuant to this law, on March 31, 1903, the court of first instance of Grenoble dissolved the order of Carthusian Monks, sequestered its entire property and appointed M. Lecouturier receiver. On April 23, 1904, the same court, in an action between the receiver and Abbé Rey and others, adjudged that the business of manufacturing liqueurs at the Grand Chartreuse, including the good will, clientage, trade-marks, commercial names, models of bottles, flacons, cases, furniture, machinery, raw material, manufactured goods and the exclusive right to the industrial name L. Garnier, was the property of the monks and passed to the receiver to be liquidated. This judgment was affirmed by the court of appeals of Grenoble and the appeal to the court of Cassation was dismissed. It thus appears that, when this action was commenced, every right and title which is in dispute here, every item of property claimed by the complainants, whether corporeal or incorporeal, tangible or intangible, were, so far as France is concerned, vested in the receiver who is represented by the defendant. The acts which the complainants seek to restrain were lawful in France, the liqueur being manufactured, bottled and labeled at the Grand Chartreuse, and sold under sanction of French law. Such a bill as we are now considering would not stand for a moment in any court of France. Of this there can be no question.

The situation as to the monks is also anomalous. Had they chosen to do so they could, with some necessary changes, have used the old labels and trade-marks in Spain, but they have seen fit not to do so, probably because the labels would have been prohibited in France and they would thus have lost the French market. They could not have used the trade-mark in the form as registered, for it would have been a falsehood and a fraud on the public to assert that liqueur made at Tarragona, Spain, was "Fabriquée à la Gde. Chartreuse" in France. Especially would this be an unfair statement in view of the oft repeated assertion of the complainants that their liqueur derived its peculiar excellence from the plants and herbs grown in the Alps in the vicinity of their monastery. However this may be, the Monks, since establishing themselves at Tarragona have de facto, though not de jure, abandoned the old labels and insignia. Their object seems to be to depart as far as possible from the former methods of dressing up their goods. One of their advertisements, containing a picture of their new bottle with labels attached, is as follows:

"The Peres Chartreux dispossessed in France of their old trade-marks, sold at auction, have carried away their secret and manufacture at Tarragona. Demand this new bottle in asking for the 'Liqueur of the Peres Chartreux' (Tarragone) or simply 'A Tarragone.'"

Their new labels and marks are totally different from the old ones and they have been particular to caution the trade that no liqueur is genuine unless bearing the new label. Their agent's circular states:

"While formerly the Liqueur derived its name from the monastery of the La Grande Chartreuse, circumstances have rendered it necessary, under the new conditions, to name it 'Liqueur Peres Chartreux' after the order of monks owning the secret process employed in its manufacture."

Assuming the right of the complainants to use the old trade-marks, it is manifest that they have not used them since their departure from France, do not wish or intend to use them and, should they do so, it would still further complicate the situation and vex the trade, with no corresponding benefit to any one. The complainants have established a new demand for their liqueur under the new labels, purchasers have learned to recognize the monks' goods by these labels and it would exhibit a lamentable lack of business sense for them to return to the old label, even if they could do so legally and truthfully.

It will be observed that at no time have the complainants designated their liqueur as "Chartreuse" on any of their paper labels. That name has been used by them principally when advertising the fact that their liqueur was "made at the Grand Chartreuse," in the same way that they now say it is made at Tarragona. There can be little doubt, however, that the name in time came to indicate the liqueurs made at the monastery in the French Alps by the monks residing there. It may be doubted whether, in this country at least, the name indicated any particular order of monks. Its primary meaning was undoubtedly geographical but it acquired afterwards a secondary meaning, so that a purchaser prior to 1901 ordering a case of "Chartreuse" would expect to receive liqueur made by monks at the French monastery.

It is not easy to believe that a person, familiar with all the facts relating to the migration of the Carthusians to Spain, could be deceived by the labels at present used by the defendant. The bill alleges on information and belief that since the removal of the complainants from France, certain persons without the complainants' consent have made a spurious imitation article falsely representing that it is made pursuant to the famous recipe of the complainants and that the defendant has imported large quantities of the spurious article, under the trade-marks and labels still owned exclusively by the complainants, and has sold the same to the American public. All this the defendant denies. The writer is of the opinion that as the complainants have alleged that the defendant has deceived the public by palming off a spurious liqueur for the genuine article, it is incumbent upon them to prove the accusation.

It is, of course, unfortunate for the complainants that their liqueur is made under a secret formula which, naturally enough, they decline to disclose; but without such disclosure we are unable to say with any degree of certainty that the two liqueurs are not substantially alike. A charge that defendant is perpetrating a fraud must be established by something more than opinions and conjecture, and es-

pecially is this true, where the party upon whom the burden rests has it in his power to establish fraud, if it exists, by proof which it will be practically impossible to contradict. We intend no criticism of the complainants' course in this regard. It is undoubtedly more profitable for them to maintain secrecy, and they are under no obligation to do otherwise. But they cannot complain if the court is unable to find that the defendant's liqueur is materially different from theirs without knowledge of its ingredients and the process by which they are combined.

It is true that experts called by the complainants denounced the defendant's liqueur as exceedingly bad, so bad in fact that the veriest tyro cannot be mistaken and yet, when asked to make the test in the presence of the commissioner they invariably declined. One of these, M. Dubonnet, testified as follows:

"Q. You could make sure of distinguishing this liqueur from the real Chartreuse? A. I do not know if I ought to reply. I have tested liqueurs enough; but one can be deceived. When I taste I taste calmly, wisely, I take precautions. Q. Will you make the experiment now? * * * A. No, because it is very delicate."

Another witness, M. Brezun, testified:

"Q. Do you consider yourself capable of distinguishing the Chartreuse made by the Carthusians from those made by the imitators? A. Certainly. Q. Will you give a proof of it at once? A. No, it is necessary to do that in the quiet of the office, when resting, with due consideration; that cannot be done in the state of nervousness in which I am at present."

It would seem, therefore, that the discovery of the difference between the two liqueurs is a grave and formal ceremony requiring the exercise of quasi judicial functions, which cannot be invoked amid the disturbing influences which usually surround the post-prandial consumption of Chartreuse. The proof of actual deception is exceedingly unsatisfactory. The facts regarding the migration of the monks to Tarragona and their adoption of entirely new labels is so well known that no one connected with the trade could be deceived. The consumer might be, but the assertion that he has been depends more upon presumption than fact.

We are thus confronted with a situation which is sui generis, it differs on the facts from all reported cases and it is hardly possible that such a combination of abnormal circumstances can ever occur again. What the defendant is doing is perfectly lawful in France. It has a right to make the liqueur, call it "Chartreuse" and sell it under the old labels. All this is not only permitted but it has the affirmative sanction of French law. The complainants, so far as the United States is concerned, have a right to do what they are doing and whatever good will pertaining to the old business remains in this country, should be conserved.

Lastly, the rights of the public are to be considered; they are entitled to protection from simulation and fraud. In the recent case

of *Siegert v. Gondolfi*, 149 Fed. 100, 79 C. C. A. 142, this court said upon somewhat similar facts:

"Undoubtedly the Siegerts did not, and could not, acquire such a monopoly in a geographical name as a trade-mark or trade-name as would entitle them to prevent others from using it under any circumstances. But it is sufficient to entitle them to relief that they used the name lawfully to designate their product until it became known to the trade by that designation, that by doing so they acquired a trade which was valuable to them, and that their business is being injured by acts of the defendants which create a dishonest competition by leading the public to believe that Abbott's Bitters are the original bitters."

Although, as before stated, there is inadequate proof of deception we cannot close our eyes to the fact that the use of the old labels alone might easily induce a purchaser, seeking the monks' cordial, to take defendant's instead. The old labels indicate to one who had long dealt in the old cordial that it was made not only at the Grand Chartreuse but also that it was made by the monks. The last representation is not expressed in so many words, but is a reasonable and fair implication from the long association of the label with the monks' product. A purchaser is compelled to rely upon external appearances and if he wanted the monks' product he would be justified in thinking he had procured it if the bottle were identical in appearance with that which contained the liqueur of years ago when he first became acquainted with it.

The defendant is the successor of the liquidator who was appointed by the French court and acted pursuant to its decree, he should not be treated as an ordinary pirate seeking by fraud to divert a legitimate business. The common sense solution of the problem, it seems to us, is to compel both parties to tell the truth about their goods. There is no false statement on either the complainants' or defendant's labels as now printed, but the use of the old labels and insignia are, to say the least, misleading. If the defendant desires to sell its liqueur on its merits there is no excuse for using labels of the same size, shape and color as the old ones with the signature, L. Garnier, the stars, the orb and the cross.

On the other hand, the defendant having acquired the right to manufacture liqueur at the Grand Chartreuse, or at Fourvoirie within the demesne of the convent, should not be debarred from whatever advantage may flow therefrom. There can be no doubt that, based partly on fact and partly on the statements of the monks, there is a general belief that the plants which grow in the Alps in the vicinity of the convent possess peculiar qualities and have an aroma indigenous to that locality. To deprive defendant of the right to mention the locality of its distillery is to deprive it of a substantial right. This right was recognized in the English case—which on appeal went strongly against the defendant—the court saying in substance that the use of the word "Chartreuse" should be enjoined if used "without clearly distinguishing the liqueurs so sold from the liqueurs manufactured by the plaintiffs."

We see no reason why the defendant should not be permitted, for instance, to use a label, printed in any language, in the following words:

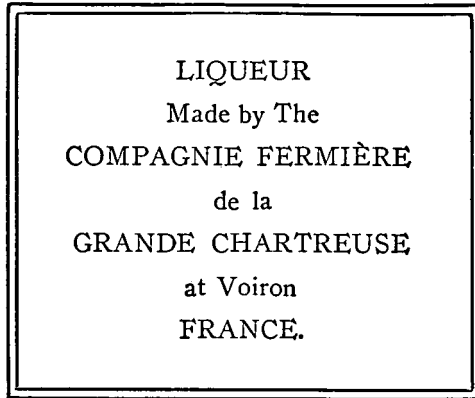

Or as follows:

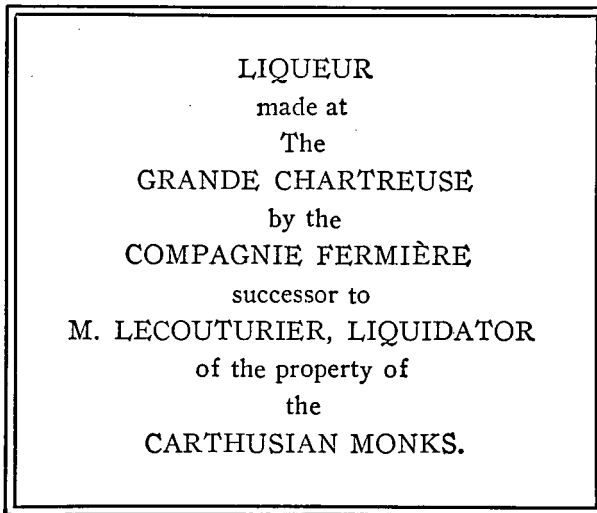

The foregoing forms are suggested, tentatively, to illustrate the labels which, in our opinion, the defendant may legally use. We do not, however, intend to be understood as intimating that the defendant should be limited to such use. So long as the purchaser is clearly made to understand that the liqueur is not the product of the monks no injury is done to the complainants. If the old labels and symbols

are abandoned we see no reason for compelling the defendant to change the shape of its bottles.

Paragraph No. 4 of the decree should be amended as follows: After the word "thereof" in line 9 (as printed on page 1568) add the following:

"Unless so used as clearly to distinguish such liqueur or cordial from the liqueur or cordial manufactured by the complainants."

In line 20 strike out the words "bottle or" and in the same line substitute the words "symbol" for the word "package" and in line 21 after the words "similar to" insert the words, "those appearing on."

The decree as amended, is affirmed without costs to either party in this court.

WARD, Circuit Judge, concurs in the result.

NOYES, Circuit Judge (dissenting). While my ultimate conclusions with respect to the decree are not in practical effect widely at variance from those of Judge COXE, the course by which I reach them is so essentially different as to require its separate presentation. An orderly examination of the questions in the case may proceed along these lines: (1) The trade-mark "Chartreuse." (2) The status and property rights of the Congregation of the Chartreux in France prior to 1901. (3) The proceedings under the association act of 1901 and their effect upon the business and trade-marks of the Congregation in France, including trade-mark rights. (4) The property rights of the Congregation in the United States. (5) The use by the defendant of the Congregation's labels and symbols.

1. For hundreds of years the establishment of the Peres Chartreux (Carthusian Fathers) was in the valley of the Chartreuse, in Dauphine, France. Whether the order originally took its name from the valley or the valley from the order is not entirely clear. But it is certain that when, some years prior to the French Revolution, the monks began to distill a liqueur for their own use the convent was known as "La Grande Chartreuse." The order was expelled from France at the time of the Revolution, but returned in the early part of the last century, and some years afterwards began to sell the liqueur which they manufactured. The liqueur was manufactured by the monks at a place near the monastery according to a secret formula which has never been divulged; but, while all the constituents are not known, it is certain that plants growing in the vicinity of the monastery were used. In fact, the monks always contended that the use of the plants grown in this region gave the liqueur much of its peculiar excellence. The liqueur was favorably received by the public. The monks composing the Congregation of the Chartreux built up and carried on an extensive business in its manufacture and sale. It was consumed all over the world.

It does not appear that any distinctive name was ever applied to this liqueur by the monks. The labels upon the bottles, however, bore the description: "Liqueur fabriquée à la Gde. Chartreuse." The public undoubtedly abbreviated this phrase to "Chartreuse." By that name

the liqueur became known, and it was applied to it for so many years that it became its trade-mark. The trade-mark "Chartreuse" thus had its origin in the name of the place where it was made—La Grande Chartreuse—and it continued to designate the place. It was also identified with that region by the belief—which, as we have seen, was fostered by the monks—that the liqueur owed many of its valuable qualities to the plants found there. But the trade-mark "Chartreuse" was more than a place name. It identified in the public mind a liqueur made by the Carthusian monks—by the Congregation of the Chartreux. The trade-mark in the one word "Chartreuse" designated both the manufacturer and the place of manufacture. Whether it came to stand for the one more than for the other is not important. It never, in my opinion, wholly lost its double signification. And even if the name "Chartreuse" had acquired a secondary meaning as designating the manufacturers—the Congregation of the Chartreux—and not the place, it was none the less a trade-mark belonging to such manufacturers and capable of transfer.

Thus we come to the year 1901 and have this situation: The Carthusian monks—Congregation of the Chartreux—at La Grande Chartreuse were carrying on an extensive business in the manufacture and sale of the liqueur designated by the valuable trade-mark "Chartreuse."

2. Prior to the French Revolution the order of Carthusian Monks composing the Congregation of the Chartreux undoubtedly owned their monastery and the adjacent territory. But at the time of the Revolution, in 1793, this Congregation, with all other religious societies in France, was suppressed, and it never had any legal organization as a corporate body afterwards. The monks were also expelled from France at that time. They returned, however, in 1816, and occupied the domain of La Grande Chartreuse as before, with the permission of the government, but without any legal title. They applied for authority to exist as a religious corporation, which would have given them the right to hold property, but this was denied. The position of the Congregation, therefore, after its return to France and until 1901, was that of an unauthorized religious association existing by the toleration of the government. It had no legal authority to hold property, real or personal; and yet it did hold property, and, as we have seen, built up an extensive manufacturing business, with the acquiescence of the government. Its legal situation was that of a *de facto* religious corporation or society, with an *appurtenant* manufacturing business.

In 1901 the associations law—as it is designated—was passed. This law made no change in the legal status of the Congregation. It did not, strictly speaking, confiscate its property, because the Congregation had no authority to hold property. It did, however, withdraw the toleration under which the Congregation had existed as a *de facto* society and provided for the appointment of liquidators to wind up its affairs. This act is said to be based upon the traditional law of France that a Frenchman shall not part with his right to own property or to marry, with which the monastic vows of "poverty, chastity and obedience" are in conflict. Its obvious purpose and effect—whatever its basis—was to force the Carthusian Monks and other similar orders out

of France. But it is not within our province to discuss the justice, wisdom, or policy of the law.

3. After the passage of the act of 1901 the Congregation of the Chartreux applied to the present government of France, as it had done to the government of the Restoration, for authorization to exist as a religious corporation. This authority was, however, denied, and in March, 1903, M. Lecouturier was appointed under the provisions of the act by a court of competent jurisdiction liquidator of "the properties of the so-called Congregation of the Chartreux, both the properties situated and held at the main house at St. Pierre des Chartreux, and also those held by the said Congregation in its different establishments." At the time of this decree, however, the Congregation of the Chartreux disclaimed ownership, as an association or society, of the trade-mark "Chartreuse" and the business connected with the manufacture of the Chartreuse liqueur, and claimed that they were the property of a former procureur of the order, Father Rey, who had been secularized for the purpose of holding them. The liquidator, however, instituted proceedings against Rey, as a result of which it was determined by the highest French courts that he was merely an interposed person or passive trustee, and that the property transferred to him in fact belonged to the Congregation of the Chartreux, and constituted part of the assets to which the liquidator was entitled. The decree in this case, which is of the utmost importance as affording the basis of the rights of the parties, is as follows:

"Declares that the business of the manufacture of liqueurs, cordials, and other products exploited at the Grande Chartreuse and at Fourvoirie under the commercial name of 'Liqueur Manufactured at the Grande-Chartreuse,' 'Vegetable Elixir of the Grande-Chartreuse,' and 'Products of the Grande-Chartreuse' including the good will and clientelage, the ownership of the trade-marks and commercial names used to designate such products, * * * and all other accessories and appurtenances generally whatsoever belonging to the aforesaid business which were the object of the deed of transfer * * * [to Rey] * * * is property held by the order, * * * and that such property forms part of the assets to be liquidated."

Attempts have been made to secure interpretations of this last decree upon the point whether it embraces foreign trade-marks; but the French courts have declined to interpret it, and it must be taken as it stands. The question, then, is this: What was the effect of these decrees upon the business and trade-marks of the Congregation?

It is contended, in behalf of the complainant, that when the monks left France they took their business and the trade-marks attached to it with them; that all the liquidator obtained was the tangible property which they left behind—"the bricks and mortar of the distillery." This contention, although supported by high authority, seems to me not well founded. Had the monks moved their establishment out of France before the appointment of a liquidator, it may be that he would have obtained nothing more than the tangible property which was left. It may be that a manufacturer can move his business from one country to another, so that a receiver of his property will take nothing but the factory and the machinery remaining in it. I do not find it necessary to determine these questions. In this case the monks did not attempt

to take their business away with them. Before the decree appointing the liquidator was entered they had transferred the business, good will, and trade-marks to Father Rey. With respect to the liquidator he held them merely as trustee for the Congregation; but as between him and the Congregation the technical title at least had passed. The monks cannot be said to have taken away their business and its incidents after the conveyance to Father Rey. To what extent the title passed—how far Rey was accountable—need not be considered. It is sufficient to say that the Congregation by the conveyance to Rey placed the title to the business, good will, and trade-marks in such situation that they could be appropriated by the liquidator. The liquidator attempted to appropriate them; Rey, with the aid of the monks, contested the liquidator's demands; and the court, having jurisdiction, decided that they belonged to the liquidator. I can reach no other conclusion than that the trade-mark "Chartreuse" and the manufacturing business to which it was an incident, so far as France is concerned, passed to the liquidator and that, as said by Judge COXE:

"Such a bill as we are now considering would not stand for a moment in any court of France."

4. The examination of the case thus far necessarily brings us to the conclusion that, unless the Congregation of the Chartreux had an independent business in this country to which the trade-mark "Chartreuse" could be considered an incident, the bill for infringement of trade-mark cannot be sustained. If the trade-mark, so far as the United States is concerned, passed with the transfer in invitum of the business in France, the complainant cannot base any demands upon it. Now there is this distinction, which differentiates this country from other countries where the right of the monks to protection in their trade-marks has been recognized notwithstanding the proceedings in France, and that is the difference in trade-mark registration laws. It may well be that, where such laws confer property rights upon the owners of a trade-mark similar to those conferred by our patent or copyright statutes, the French decree and the transfer of the French business would not affect the registered trade-marks. But our trade-mark act confers no such rights. It merely brings pre-existing property rights within the cognizance of federal courts in certain instances, but in no sense confers such rights. *Sarrizin v. W. R. Irby Cigar & Tobacco Co.*, 93 Fed. 624, 35 C. C. A. 496, 46 L. R. A. 541, and cases there cited. The registry of the trade-marks in this country in the name of Grezier, procureur, therefore, neither adds anything to, nor takes anything away from, the complainant's case.

What property rights, then, did the Carthusian Monks have in this country? What business had they here to which the trade-marks were an incident? It is not contended that they had any tangible property here. It is not claimed that they manufactured any of the liqueur here. The most that appears is that their manufactured product had been sold in this country for many years through the agency of the firm of Batjer & Co., of New York. But their methods of doing business are not shown. In view of the fact that the witness Batjer speaks of his "profits" and of his expenditures for advertising, it

would seem probable that his firm had the exclusive right of purchase of the monks' products from their European representative, rather than that they were agents upon a commission basis—in other words that the liqueur sold by Batjer & Co. belonged to that firm upon its arrival in this country. Be that as it may, I find nothing in the record showing that the monks had any such separate business in this country that a good will attached to it as distinct from the good will of the business in France. The manufacturing business was located in that country alone. The good will attached to it there, and I know of no principle upon which such good will can be divided and subdivided. If the Carthusian Monks have property rights in this country in the name "Chartreuse" unaffected by the French decrees, then every American manufacturer shipping goods to foreign countries who goes into bankruptcy and whose business and trade-marks are sold still retains property rights in such trade-marks abroad and may prevent their purchaser from engaging in foreign trade.

It is my opinion that the business of the Congregation of the Chartreux was located in France, that the good will followed the business, and that the trade-mark "Chartreuse" followed as an incident to the good will. I am convinced that, had the Congregation sold its business and used language much more limited in scope than appears in the French decrees, the trade-mark "Chartreuse" would have passed with it for all the world; and I see no difference between a voluntary conveyance and a transfer by operation of law—especially a transfer in connection with a voluntary conveyance, that to Father Rey. For these reasons, and with reluctance in view of the nature of the case and of the high authorities holding contrary views, I am of the opinion that the Carthusian Monks—Congregation of the Chartreux—are not entitled to relief based upon their ownership of the trade-mark "Chartreuse."

This is as far as it is necessary to go in this part of the case. The complainants must recover by the strength of their own title, and not by the weakness of the defendants. If the Carthusian Monks have lost their rights to the trade-mark, it is not material here whether the liquidator and his assignee—the Compagnie Fermière de la Grande Chartreuse—are using the trade-mark properly or not. It would not help their case that the liquidator had acquired a trade-mark which he could not lawfully use. It would not aid them if the court should be of the opinion that a deception was being practiced upon the public by describing as "Chartreuse" a liquid obtained only through the use of the sense of taste and "groping in the dark." If the public are being deceived, the courts will never afford affirmative relief to the defendant, and possibly public remedies against it might be available. But no wrongful use of the trade-mark entitles the complainants to relief if they have lost all rights in it.

It is, I think, a theory wholly without foundation that there could have been no separation of the trade-mark "Chartreuse" from the secret formula; that, as the liquidator failed to acquire the formula, he could not legally have acquired the trade-mark. The formula was either indispensable or unnecessary for the preparation of the product

to which the trade-mark could truthfully apply. In the one case it is manifest that the liquidator could, in the absence of the formula, manufacture the product and use the trade-mark without deceiving the public. In the other he would simply have acquired property of which he could make no use until he obtained the formula. But he would have owned it none the less. It would no more have reverted to the complainants than would one of the trade-marks of a proprietary medicine business revert to its vendors because its formula was lost or mislaid, or because an employé possessing exclusive knowledge of the secret process refused to disclose it. As already indicated, the absence of the formula relates rather to the weakness of the defendant's case than to the strength of the complainants'. It may well be that neither the complainants nor the defendant have now the right to use the trade-mark "Chartreuse"—the complainants, because it has been taken away from them by legal process; the defendant, because it cannot be used without deceiving the public. But the defendant's situation does not benefit the complainants here.

5. But while, in my opinion, the trade-mark "Chartreuse" passed to the liquidator and his assignee, it does not follow that the symbols of the orb and the cross upon the labels likewise passed and gave such assignee the right to use them upon its products. Such symbols are of a religious nature, are distinctly personal to the monks, and could not be taken from them. The fact that the liquidator seized certain labels and had others printed gave him no right to use the religious symbols of the monks. And this is true in less degree of the stars, and of the signature of the officer of the order, "L. Garnier." Unlike the trade-mark "Chartreuse," these symbols and name are personal to the monks, and they should be protected from their misappropriation and use by the defendants. I cannot adopt the view that the *Compagnie Fermière de la Grande Chartreuse* could acquire the right to use these symbols.

For these reasons I am of the opinion that the decree of the Circuit Court should be so modified as to restrain the defendants only from using the said symbols and the name "L. Garnier," and should not relate to the use of the trade-mark "Chartreuse." In reaching this conclusion, however, I am not unmindful of the fact that the opinion of the majority of the court in requiring each party to tell the truth not only does exact justice between them but protects the public from deception. The result is so equitable that, were it not for my inability to appreciate the complainants' standing to obtain such a decree, I should concur in it.

REPUBLIC IRON & STEEL CO. et al. v. TOBIN.

(Circuit Court of Appeals, Eighth Circuit. September 4, 1908.)

No. 2,829.

MASTER AND SERVANT—INJURY TO SERVANT—CONTRIBUTORY NEGLIGENCE.

Plaintiff had been employed for several months by defendant, a mining company which was engaged in stripping the ore bed; the earth being removed to a dump by means of two trains of cars. The tracks were in the form of a Y; one branch being the loading track and the other leading to the dump. It was the custom, known to plaintiff, for the loaded train to back to the end of the connecting or tail track and wait until the empty train had backed onto such track a sufficient distance to switch to the loading track, and then follow it out, taking the other track. At a time when the empty train had just passed from the tail track to the loading track plaintiff started to walk along the dump track, with his back toward the tail track, and was struck and injured by the loaded train, which was moving at a speed of 7 or 8 miles an hour. From the center of the track where he was walking plaintiff could have seen the approaching train for a distance of 400 feet, but he did not look after going upon the track. *Held*, that he was guilty of contributory negligence, which precluded a recovery for the injury.

[Ed. Note.—For cases in point, see Cent. Dig. vol. 34, Master and Servant, §§ 706-708.]

In Error to the Circuit Court of the United States for the District of Minnesota.

Oscar Mitchell (Washburn, Bailey & Mitchell, on the brief), for plaintiffs in error.

Samuel Anderson, for defendant in error.

Before SANBORN and VAN DEVANTER, Circuit Judges, and W. H. MUNGER, District Judge.

W. H. MUNGER, District Judge. On January 31, 1907, plaintiff, while in the employ of the Republic Iron & Steel Company, one of the defendants, was run over by a train of cars operated by said defendant, thereby losing his right leg. The engineer of the train is a codefendant.

The defendant Republic Iron & Steel Company is a mining corporation, and at the time of plaintiff's injury was engaged in removing the earth from the surface of the mine above the ore beds. In this work a steam shovel was employed, which removed the earth from place and loaded it onto cars standing on what is denominated in the evidence as the "loading track." When the cars in the train were all loaded, the train would back down upon what is denominated the "tail track," and then from the tail track would push the cars onto and along the dump track to the unloading dump, something like a quarter to half a mile away. Two trains were used in doing the work. The loading track and the dump track were nearly parallel at the point where plaintiff received his injury, and about 30 feet apart. These two tracks were connected with the tail track by a switch, so that the tracks together nearly resembled the letter Y. The train which first reached the switch, usually the loaded one, would back down to the lower end of the tail track. The other train would then back down onto the

tail track, go out through the switch onto the track upon which it was to go, and the train at the lower end of the tail track would come out onto the track upon which it was to go. In this manner the two trains passed in going and returning from the loading place to the unloading dump. The tracks ran in an easterly and westerly direction. Some 8 or 10 feet south of the unloading or dump track was a water tank from which the water required by the steam shovel was supplied by means of a hose which ran from the water tank under the rails of the tracks to the shovel. As the shovel moved forward in its work, it was necessary from time to time to change the location of the hose under the rails. Plaintiff was engaged in changing the location of the hose when he was run over by a loaded train, going to the dump at a speed of from 7 to 10 miles an hour.

The act of negligence charged against the defendants is the failure to give the usual and customary signal of blowing the whistle by the train in passing from the tail track to the dump track. The evidence as to whether such signal was given may possibly be said to be conflicting, though there would be much reason in holding that its character is such that the rule respecting the relative weight of affirmative and negative testimony announced by this court in *C. & N. W. Ry. Co. v. Andrews*, 130 Fed. 65, 64 C. C. A. 399, should be applied. But we pass that question, because we think plaintiff, by his own testimony, established such contributory negligence as prevents his right to recover.

Plaintiff entered the employ of the defendant company about the 7th of May, 1906, as track foreman, and continued as such foreman until about the middle of November following, when his work changed to looking after the repair and oiling of the cars and supplying the steam shovel with water, in which work he had several men under him. He thus became perfectly familiar with the manner in which the work was conducted, and also all the surrounding conditions. He testifies that just before the injury he had supplied the steam shovel with water, went to the water tank, turned the water off, and with two of the workmen under him was pulling the hose out from under the rails for the purpose of changing its location. They were on the south side of the unloading track, when a joint in the hose caught on the north rail of the track. He went across the track to release the hose, and just before going across he looked up and down the track and did not see any train. After releasing the hose he turned toward the east and proceeded down the center of the track toward the dump, looking for a good place under the rails through which to run the hose. He proceeded but a few feet when one of his men hollered, and, turning around, he saw the train nearly onto him. He tried to jump from the track, and got about over the rail, when the car struck him on the side and threw him in such a manner that his right leg was run over. He says he did not know whether the loaded train was on the tail track or not; but he saw the train with the empty cars going to the shovel, and must have known that the loaded train would move out from the tail track immediately thereafter. He says he did not pay any attention to the moving of the trains; but his work at the water tank and

at the shovel was within a few feet of the place where he was injured, and the movement of the trains would be known by a casual observer. From the place where he was when he looked for the train he could only see toward the tail track from 150 to 175 feet, owing to an embankment and a slight curve in the track; but when in the center of the track between the rails, had he looked, he could have seen the train up to the switch, about 400 feet away. One of the trains passed the point where he was as often as once every 15 minutes during the day. When he went onto the track and released the hose he was facing across the track, and a side glance up toward the switch would have disclosed to him the approach of the train, yet knowing that from the point where he looked he could only see some 150 to 175 feet, and that as soon as he stepped into the center of the track his view could extend some 400 feet, he did not look the second time, but after releasing the hose deliberately turned with his back toward the west, the direction from which he must have known the train would come, knowing that it would follow immediately after the empty train which he saw moving up the shovel track, and started down the center of the track to look for a good place through which to draw the hose. This observation should more appropriately have been made from outside the rails.

As before stated, he had been at work there since about the 7th of May, was familiar with existing conditions, the frequency with which the trains passed back and forth, that, had he looked after going upon the track, he could have seen much farther along the track in the direction from which he must have known a train would shortly come. He must be held to have known that a railroad track was a place of danger, yet with all such knowledge he chose to go into such place of danger, stooped over, loosened the hose, then started down the track, with his back toward the approaching train, without taking any caution to observe the train, except, as before stated, at a point where his view was obstructed beyond 150 to 175 feet. Had he looked, as was his duty, after going upon the track, where his view was unobstructed for some 400 feet, and before starting to walk along the track, he would have seen the approaching train. But this he did not do, and such negligence on his part was a contributing and proximate cause of the injury, for which no recovery can be had. The facts bring the case clearly within the law as stated in *Grand Trunk Ry. Co. v. Baird*, 36 C. C. A. 574, 94 Fed. 946; *Aerkfetz v. Humphreys*, 145 U. S. 418, 12 Sup. Ct. 835, 36 L. Ed. 758; *Elliott v. C. & M. & St. P. Ry. Co.*, 150 U. S. 245, 14 Sup. Ct. 85, 37 L. Ed. 1068; *Spaven v. Lake Shore & M. S. Ry. Co.*, 130 Mich. 579, 90 N. W. 325; *Keefe v. C. & N. W. Ry. Co.*, 92 Iowa, 182, 60 N. W. 503, 54 Am. St. Rep. 542; *Wabash R. Co. v. Skiles*, 64 Ohio St. 458, 60 N. E. 576; *Morris v. B. & M. Ry. Co.*, 184 Mass. 368, 68 N. E. 680; *Carlson v. Cincinnati, S. & M. R. Co.*, 120 Mich. 481, 79 N. W. 688.

At the close of all of the evidence defendant requested the court to direct a verdict in its favor, which request was overruled, and an exception taken. This instruction should have been given.

The case is therefore reversed, with directions to grant a new trial.

DENVER CITY TRAMWAY CO. v. COBB.†

(Circuit Court of Appeals, Eighth Circuit. September 5, 1908.)

No. 2,558.

1. STREET RAILROADS—INJURY AT CROSSING—CONTRIBUTORY NEGLIGENCE.

The law gives no right of recovery for an injury sustained by a pedestrian in a collision with a car at a street crossing, where both parties are negligent, each disregarding his own duty and seemingly relying upon a performance of the duty of the other, and where the injury resulting from their concurring negligence would have been avoided if the duty of either had been performed.

2. SAME—DUTY OF PEDESTRIAN—LOOKING ALONG TRACKS FOR APPROACHING CAR.

The law requires a pedestrian, about to cross over a street railroad, to look along the tracks to ascertain whether a car is approaching near by, and to do so at a place and time when it will be reasonably calculated to be effectual for his protection.

[Ed. Note.—For cases in point, see Cent. Dig. vol. 44, Street Railroads, § 208.]

3. SAME—CONTRIBUTORY NEGLIGENCE—“LAST CHANCE DOCTRINE.”

The exception to the general rule making contributory negligence a defense, known as the “last chance doctrine,” does not apply where there is no negligence of the defendant supervening subsequently to that of the plaintiff, as where his negligence is continuous and operative down to the moment of the injury, or where his negligence or position of danger is not discovered by the defendant in time to avoid the injury.

[Ed. Note.—For cases in point, see Cent. Dig. vol. 44, Street Railroads, § 219.]

(Syllabus by the Court.)

In Error to the Circuit Court of the United States for the District of Colorado.

Howard S. Robertson and Gerald Hughes (Charles J. Hughes, Jr., on the brief), for plaintiff in error.

Stephen W. Ryan and Edmund F. Richardson (Horace N. Hawkins, on the brief), for defendant in error.

Before SANBORN and VAN DEVANTER, Circuit Judges, and PHILIPS, District Judge.

VAN DEVANTER, Circuit Judge. This was an action to recover for personal injuries sustained by the plaintiff in a collision with a street car in the city of Denver. In its answer and at the trial the defendant took the position that, even conceding its negligence, the plaintiff was without right of recovery, because of contributory negligence on his part; and our attention has been chiefly directed to the question of whether or not this defense was established so conclusively that a verdict for the defendant should have been directed. In that view of the evidence which is most favorable to the plaintiff, and is yet a reasonably permissible one, the facts are these:

The collision occurred at the junction of Tremont and Broadway streets, where the defendant has a double-track electric street railway passing from one street into and along the other. Broadway extends north and south, and Tremont departs from it in a southwesterly

*Rehearing denied November 7, 1908.

direction at an angle of about 45 degrees. The turn or curve in the car tracks is around the obtuse angle, and the crossing on the line of the west sidewalk of Broadway is diagonal to Tremont; the curb or end of the sidewalk on the south being upwards of 50 feet from the northerly or inbound track. In walking north over this crossing the plaintiff collided with an inbound car and was injured. It was daytime, and there was a plain view of the tracks in both directions, save as it was temporarily obstructed by some moving vehicles. The plaintiff knew of the car tracks and their customary use, and was familiar with the movement of electric cars in large cities. He was 57 years old, was in full possession of his faculties, and frankly confesses that he was in no wise excited or flurried. Before leaving the sidewalk he looked along both streets, but saw no car. The inbound car was approaching in Broadway at the time, and would have been in plain view but for a covered express wagon, which was also approaching in front of it. As he advanced toward the tracks a coal wagon passed into Broadway in front of him, and this temporarily obstructed his view and checked his advance. He then passed by the rear of this wagon and came to be a little south of the southerly or outbound track and about 12 feet from the inbound track. The inbound car was then in plain view, was about 45 feet away, and was approaching at a speed of from 5 to 7 miles an hour, its usual speed at that place. A single witness for the plaintiff estimated that it was moving 15 miles an hour; but other parts of his testimony indicate that his estimate was incorrect, and the other witnesses testifying to that point united in placing the maximum speed at 7 miles. Without any further attempt to look along the tracks, and without observing the car, which continued to be in plain view, the plaintiff advanced to the inbound track and the collision ensued. Immediately before, a light wagon passed along the north side of that track, quite close to it, and this caused him momentarily to check his advance; but he says that he does not remember whether he had then reached that track, and the statement of his principal witness is that the plaintiff and the car reached the point of collision "practically together." Another of his witnesses, who was looking toward this crossing from a point two blocks down Tremont street, says that the car was coming around the curve into that street when the plaintiff was at the south rail of the outbound track. Finally, the evidence as a whole makes it entirely certain that he went in front of the advancing car when to do so was dangerous, when the car could not be stopped in time to avoid a collision, and when, had he, after his view became unobstructed, looked in the direction from which the car was coming, he would have observed its approach in ample time to have made the collision impossible.

The negligence of the defendant consisted in a failure to give a timely signal or warning of the approach of the car, and in a failure to make timely observation of the surroundings at the crossing, so that the speed might be checked, or the car stopped, in time to avoid a collision, if there was occasion to apprehend one. But the injury was not willfully or wantonly inflicted. On the contrary, when it was

discovered that a collision was probable, all was done that could be done to avoid it, and the car was stopped within the shortest possible distance. We think the case is plainly one where both parties were negligent, each having disregarded his own duty, and seemingly relied upon a performance of the duty of the other, and where their concurring negligence resulted in an injury which would have been avoided if the duty of either had been performed. In such a case the law gives no right of recovery. *Schofield v. Chicago, Milwaukee & St. Paul Ry. Co.*, 114 U. S. 615, 5 Sup. Ct. 1125, 29 L. Ed. 224; *Chicago & N. W. Ry. Co. v. Andrews*, 64 C. C. A. 399, 408, 130 Fed. 65, 74; *Id.*, 195 U. S. 628, 25 Sup. Ct. 787, 49 L. Ed. 351; *Chicago, R. I. & P. Ry. Co. v. Crisman*, 19 Colo. 30, 34 Pac. 286; *Hafner v. St. Louis Transit Co.*, 197 Mo. 196, 94 S. W. 291; *O'Brien v. St. Paul City Ry. Co.*, 98 Minn. 205, 108 N. W. 805.

But it is urged that the plaintiff's duty was performed because, before leaving the sidewalk, he looked along both streets and saw no car. It must be held otherwise. The purpose in requiring him to look at all made it necessary that he should do so at a place and time when it would be reasonably calculated to be effectual for his protection. His looking at the time and place selected did not satisfy this requirement. His view along Broadway was then so obstructed that the car, which the collision showed was in close proximity to the crossing, could not be seen by him. It was after he passed the coal wagon that his view became unobstructed. He should have looked again at that time, and his failure to do so was negligence. *Chicago Great Western Ry. Co. v. Smith*, 73 C. C. A. 164, 141 Fed. 930; *Saltman v. Boston Elevated Ry. Co.*, 187 Mass. 243, 72 N. E. 950; *Bartlett v. Worcester Consolidated St. Ry. Co.*, 189 Mass. 360, 75 N. E. 706; *Hafner v. St. Louis Transit Co.*, *supra*; *Colorado & S. Ry. Co. v. Thomas*, 33 Colo. 517, 81 Pac. 801, 70 L. R. A. 681.

It is also urged that the case is within that exception to the general rule making contributory negligence a defense, which is known as the "last clear chance doctrine." But there are two reasons why that is not so: First. The exception does not apply where there is no negligence of the defendant supervening subsequently to that of the plaintiff, as where his negligence is continuous and operative down to the moment of the injury. *St. Louis & San Francisco Ry. Co. v. Schumacher*, 152 U. S. 77, 81, 14 Sup. Ct. 479, 38 L. Ed. 361; *Illinois Central R. Co. v. Ackerman*, 76 C. C. A. 13, 144 Fed. 959; *Missouri Pacific Ry. Co. v. Moseley*, 6 C. C. A. 641, 57 Fed. 921; *Gilbert v. Erie R. Co.*, 38 C. C. A. 408, 97 Fed. 747. Second. The exception does not apply where the plaintiff's negligence or position of danger is not discovered by the defendant in time to avoid the injury. *Chunn v. City & Suburban Ry. Co.*, 207 U. S. 302, 309, 28 Sup. Ct. 63, 52 L. Ed. 219; *Illinois Central R. Co. v. Ackerman*, *supra*; *Fonda v. St. Paul City Ry. Co.*, 71 Minn. 438, 451, 74 N. W. 166, 70 Am. St. Rep. 341; *Alger, Smith & Co. v. Duluth, etc., Co.*, 93 Minn. 314, 101 N. W. 298; *Bennichsen v. Market St. Ry. Co.*, 149 Cal. 18, 84 Pac. 420; *Cullen v. Baltimore & P. R. Co.*, 8 App. D. C. 69; *Rider v. Syracuse Rapid Transit Co.*, 171 N. Y. 139, 63 N. E. 836, 58 L. R. A.

125; Chicago, R. I. & P. Ry. Co. v. Crisman, 19 Colo. 30, 34 Pac. 286; Denver & R. G. R. Co. v. Spencer, 25 Colo. 9, 52 Pac. 211; Cooley on Torts (3d Ed.) 1442-1445; 3 Elliott on Railroads (2d Ed.) § 1175.

As it follows that a verdict for the defendant should have been directed, the judgment is reversed, with a direction to grant a new trial.

NADAY & FLEISCHER v. UNITED STATES.

(Circuit Court of Appeals, Second Circuit. September 1, 1908.)

Nos. 246, 252.

CUSTOMS DUTIES—CLASSIFICATION—"TRIMMINGS"—COMMERCIAL DESIGNATION. In Tariff Act July 24, 1897, c. 11, § 1, Schedule L, par. 390, 30 Stat. 187 (U. S. Comp. St. 1901, p. 1670), which contains a long enumeration including "galloons," "braids," and "trimmings," the term "trimmings" is used in a commercial, rather than a descriptive sense.

[Ed. Note.—For other definitions, see Words and Phrases, vol. 8, p. 7109.

Interpretation of commercial and trade terms in tariff laws, see note to Dennison Mfg. Co. v. United States, 18 C. C. A. 545.]

Appeal from the Circuit Court of the United States for the Southern District of New York.

This cause comes here upon appeal by the importers from a decision of the Circuit Court (155 Fed. 303), which affirmed a decision of the Board of General Appraisers (G. A. 5,923; T. D. 26,049) as to classification of certain articles for tariff duty. Appeals in several other causes are incorporated in the record, but the only one in which there is before us any return by the board is No. 3,918. This decision, therefore, is an express adjudication only as to the goods considered in that cause.

Comstock & Washburn (Albert H. Washburn, of counsel), for importers.

J. Osgood Nichols, Asst. U. S. Atty.

Before LACOMBE, COXE, and WARD, Circuit Judges.

PER CURIAM. The collector classified the articles under Tariff Act July 24, 1897, c. 11, § 1, Schedule L, par. 390, 30 Stat. 187 (U. S. Comp. St. 1901, p. 1670), which imposes a duty of 60 per cent. upon a great many articles made of silk or of which silk is the component of chief value. The long enumeration includes "galloons," "braids," and "trimmings." The importers contend that the articles come under paragraph 391 as manufactures of silk or of which silk is component of chief value, dutiable at 50 per cent.

In our opinion the word "trimmings" in the paragraph cited is not used in a descriptive sense. The cases relied upon (such as Hartranft v. Meyer, 149 U. S. 544, 13 Sup. Ct. 982, 37 L. Ed. 840), construing the act of 1883, are not controlling, because the paragraph therein construed contained the phrase "used for making or ornamenting hats, bonnets and hoods." The *eo nomine* designation should be given the meaning it has in trade and commerce.

There is much conflict in the testimony, but we are inclined to concur with the board that the articles (in case 3,918) now before us are within the trade meaning of "galloons" or "trimmings," except some which may more appropriately be classified as "braids." As such they fall within paragraph 390.

There are some samples which the evidence shows to be what are known in trade and commerce as "beltings," which are covered by a different paragraph (389) and dutiable at 50 per cent. Apparently none of these are included among the items in case 3,918. If any such have been overlooked, counsel may agree as to which they are, and they may be specified in the decree.

The decision of the Circuit Court in case 3,918 is affirmed; in the other cases, appeals are dismissed.

UNITED STATES v. GEORGE.

(Circuit Court of Appeals, Second Circuit. May 5, 1908.)

No. 254.

ALIENS—INTENTION OF CITIZENSHIP—MINORS—DECLARATION—COMPETENT AGE.

Under section 2165, Rev. St. (U. S. Comp. St. 1901, p. 1329), providing that aliens may be admitted to citizenship where a declaration of intention shall have been filed at least two years before admission, *held*, that such declaration might be made by a minor who had reached years of discretion, and that one made by an alien 19 years old was sufficient.

[Ed. Note.—Citizenship under state and federal laws, see note to *City of Minneapolis v. Reum*, 6 C. C. A. 37.]

Appeal from the Circuit Court of the United States for the Southern District of New York.

Hugh Govern, Jr., Sp. Asst. U. S. Atty.

Before LACOMBE, COXE, and NOYES, Circuit Judges.

LACOMBE, Circuit Judge. Henry George, the appellee, was born in England on or about August 14, 1873. He landed in the United States June 1, 1892, and on December 16th in the same year appeared in the Superior Court of the City of New York and declared his intention to become a citizen of the United States, under section 2165, Rev. St. (U. S. Comp. St. 1901, p. 1329). He was then over 19 years of age. On October 14, 1907, he duly filed his petition to be admitted as a citizen in accordance with subdivision 2 of section 4 of the naturalization act (Act June 29, 1906, c. 3592, 34 Stat. 596 [U. S. Comp. St. Supp. 1907, p. 421]), and submitted in support and as a part thereof a certified copy of the above-described declaration of intention. On January 28, 1908, his said petition came on for final hearing. The United States attorney objected to the granting thereof on the ground that, as his declaration of intention was made when he was under 21 years of age, it was null and void. The court overruled the objection, holding that a minor could make a valid declaration of inten-

tion after he had reached the age of 18 years, and admitted the appellee to citizenship.

The statutory provision in force when George made his declaration of intention is as follows:

"Sec. 2165 [Rev. St. U. S.]. An alien may be admitted to become a citizen of the United States in the following manner and not otherwise:

"First: He shall declare on oath before a * * * court of record of any of the states having common-law jurisdiction, and a seal and clerk, two years at least prior to his admission that it is bona fide his intention to become a citizen of the United States and to renounce forever all allegiance and fidelity to any foreign prince, potentate, state or sovereignty and particularly by name to the prince, potentate, state or sovereignty of which the alien may be at the time a citizen or subject. * * *

"Third: It shall be made to appear to the satisfaction of the court admitting such alien that he has resided within the United States five years at least," etc.

"Sixth: * * * the declaration of intention * * * may be made by an alien before the clerk of any of the courts named * * * in said section."

This section, and the earlier acts of April 14, 1802, and May 26, 1824, contain no requirement as to the age to which an alien shall have attained before he is entitled to make his declaration of intention. In the absence of such requirement it would seem reasonable to hold that such declaration might be made during minority, provided the declarant had reached years of discretion.

It is contended, however, that this matter of the abdication by an individual of allegiance to one sovereign and the undertaking of allegiance to another is of such great importance and grave solemnity that decision thereon should be made only by persons who have attained full legal age. We do not find this argument persuasive, in view of the provisions of section 2167, which dispensed with the declaration of intention two years in advance of naturalization for those who arrived here under 18 years of age. That section required the petitioner to "declare on oath and prove to the satisfaction of the court that for two years next preceding, it has been his bona fide intention to become a citizen of the United States." Since application under this section could be made immediately after arriving at the age of 21, Congress evidently assumed that persons over 19 years of age were competent to form a bona fide intention to abdicate one allegiance and undertake another. It may be noted that this construction harmonizes with the present act (June 29, 1906), which provides (section 4) that declaration of intention may be made after the alien has reached the age of 18 years.

The judgment is affirmed.

EASTERN DYNAMITE CO. v. KEYSTONE POWDER MFG. CO.

(Circuit Court, M. D. Pennsylvania. September 1, 1908.)

No. 20, May Term, 1906.

1. PATENTS—ASSIGNMENT—CERTIFIED COPY OF RECORD AS EVIDENCE.

A certified copy of the record of an assignment of a patent with the acknowledgment thereto, although made evidence where the original would be evidence by Rev. St. § 892 (U. S. Comp. St. 1901, p. 673), does not prove the genuineness or due execution of the original assignment, nor is it given such effect by section 4898, as amended by Act March 3, 1897, c. 391, § 5, 29 Stat. 692 (U. S. Comp. St. 1901, p. 3387), which makes a certificate of acknowledgment under seal prima facie evidence of the execution of such an assignment.

[Ed. Note.—For cases in point, see Cent. Dig. vol. 38, Patents, § 280.]

2. SAME — ASSIGNMENT OF FUTURE INVENTIONS—PATENT OFFICE—RECORD—NOTICE.

A written instrument by which an inventor purports to assign all future inventions which may be made by him is not such an instrument as is authorized by statute to be recorded in the patent office, and hence such record, if made, is not notice to a subsequent assignee of a patent obtained by such inventor which will invalidate his title.

3. SAME—INVENTION.

Inventors are not held to the devising of new mechanical forms, or the discovery of hitherto unknown physical principles, but only to the new adaptation and application of those which are already at hand, the question being whether, having regard to what there has been in the past, new and beneficial results have been produced by means not before employed, amounting to inventive advance; and this is not met by evidence that with the new light possessed old devices might possibly be made over to do the same thing.

[Ed. Note.—For cases in point, see Cent. Dig. vol. 38, Patents, §§ 31, 32, 55-62.]

4. SAME—RIGHT TO PATENT—ASSISTANCE IN PERFECTING INVENTIONS.

One who has discovered a new principle in a machine does not lose his right as inventor to a patent therefor, because he employs another to put it in working shape, nor because such other may suggest minor features or improvements.

[Ed. Note.—For cases in point, see Cent. Dig. vol. 38, Patents, § 125.]

5. SAME—INFRINGEMENT—MACHINE FOR PACKING EXPLOSIVE GELATIN.

The Schrader patent, No. 682,390, for a machine for packing explosive gelatin was not anticipated, and discloses invention, although claims 1, 2, 3, 4, and 16 are void as too general and abstract. The patent also *held* valid as against the claim that the patentee was not the original inventor, and infringed as to claims 5, 6, 7, and 8.

6. SAME—ATTEMPT TO PATENT OPERATIVE IDEA OR PRINCIPLE.

A mere operative idea or principle cannot be patented, and a mechanical device designed to accomplish certain practical results in the packing of explosive gelatin is therefore confined to the specific means employed for doing so.

7. SAME—"MEANS" OTHERWISE UNSPECIFIED, EXCEPT BY THE FUNCTION TO BE PERFORMED, WHEN NOT ADMISSIBLE.

It is no doubt difficult to define the distinction between a practically operative machine and its function. And it may be at times permissible to claim as an element of a combination "means," otherwise unspecified, for effecting a certain mechanical result, particularly in inventions of a broad and primary character. But where, in a device not of that character, the attempt is made to monopolize the abstract result sought to be attained, instead of the concrete mechanism devised for doing so, as

for instance, in the claims of a patent for a machine for packing explosive gelatin, where, after specifying a packing screw and its case as the first member of the combination declared for, the second member claimed is an "automatically regulated feeding mechanism for variably supplying material to said case in response to variations in the quantity consumed by said screw," and in another claim, after specifying the packing screw and hopper, the other elements are "means for feeding material therefrom to said screw, and means whereby the amount conveyed to said screw will be automatically varied in response to variations in the quantity consumed by said screw," the attempt so made being to indicate or describe the means to be employed solely by the function assigned to it; the claims are bad as the patenting of a principle or function.

8. SAME — FAILURE TO MARK PATENTED ARTICLE — RIGHT TO ACCOUNT FOR INFRINGEMENT AFTER BILL FILED.

Where there is no proof that the patented machine was marked as required by the statute, and issue is made as to this in the answer, notice not being shown to have been otherwise given, the complaint will be confined in the accounting to infringement after the bill was filed, but is entitled to that; the bill itself being notice.

In Equity. Suit for infringement of letters patent No. 682,390 for a machine for packing explosive gelatin, issued September 10, 1901, to J. C. Schrader. On final hearing.

George J. Harding, for complainant.

George R. Hamlin, for defendant.

ARCHBALD, District Judge. The first thing is to settle the complainant's title, which is questioned. By agreement in writing, while the application for the patent in suit was pending, J. C. Schrader, the patentee, covenanted and agreed to assign to the Eastern Dynamite Company, the complainant here, its successor and assigns, the letters patent which had been applied for, when they should be granted, and to execute all necessary and proper papers and do all acts requisite to invest the said company with full title to the invention and patent. Having died before this was complied with, and letters patent having issued to him September 10, 1901, meantime, an assignment of the patent, in conformity with the agreement and of all claims for infringement under it, was duly executed to the complainant by Amelia H. Schrader, his executrix, January 16, 1906, which assignment was forthwith acknowledged, and eventually put on record in the patent office, and is now produced and proved by the subscribing witnesses, due delivery of it being presumed from these circumstances.

Against the prima facie proof of title so made out, the defendants offered in evidence a certified copy of the record in the patent office of a paper purporting to be an agreement, bearing date April 11, 1889, between J. C. Schrader and R. S. Penniman of the one part, and the Repauno Chemical Company, of Wilmington, Del., and the Atlantic Dynamite Company, of San Francisco, Cal., of the other part, a summary of which is reproduced in the margin.¹ This paper, according to

¹ Reciting that, whereas Schrader and Penniman were the owners and patentees of certain patents for explosive compounds or substances—naming such patents—and had also made application for one for the manufacture of dope therefor, and that the second parties were desirous of acquiring an interest in said patents, and in and to all inventions and discoveries which had

the record, was acknowledged before a notary public the same day that it bears date, and was recorded in the patent office December 30, 1890. Objection was made to its admission because it had not been properly proved, and the objection seems to be well taken. No doubt by act of Congress (Rev. St. § 892 [U. S. Comp. St. 1901, p. 673]):

“Written or printed copies of any records, papers or drawings, belonging to the patent office * * * authenticated by the seal, and certified by the commissioner or acting commissioner, shall be evidence in all cases wherein the originals could be evidence.”

But this merely dispenses with the production of the record, a certified copy from it being made the equivalent. It does not establish the due execution or genuineness of a paper which happens to be found there, which must still be proved in the usual way. Nor is this affected by the act of March 3, 1897, c. 391, § 5, 29 Stat. 692 (U. S. Comp. St. 1901, p. 3387), which provides that, if any assignment, grant, or conveyance of a patent shall be acknowledged before a notary public, or certain other designated officers, “the certificate of such acknowledgment under the hand and official seal of such notary or other officer, shall be prima facie evidence of the execution of such assignment, grant, or conveyance.” An assignment so authenticated does not have to be otherwise proved, as by calling the subscribing witnesses, or by proof of the handwriting of the party who executed it. But the document itself must still be produced, and not a certified copy taken from the record, which in no respect is made a substitute. For the purpose of notice, an assignment of a patent is required to be recorded within three months, and if not so recorded is made void as against a subsequent purchaser or mortgagee for value, without notice. Rev. St. § 4898 (U. S. Comp. St. 1901, p. 3387). But, while constructive notice may be effectively provided for in this way, parties being thereby put upon inquiry, inquiry is by no means excused, nor can the record alone be relied on to make out title, however it may be resorted to, to trace it. No doubt there are authorities entitled to respect which hold otherwise (*Dederick v. Agricultural Co.* [C. C.] 26 Fed. 763; *Natl. Folding Box Co. v. American Paper Pail Co.* [C. C.] 55 Fed. 488; *Standard Elevator Co. v. Crane Elevator Co.*, 76 Fed. 767, 22 C. C. A. 549); but not, in my judgment, with reason,

been or should thereafter be made by the said first parties, relating to any and all kinds of explosive compounds and substances containing nitroglycerin, and in the machinery and appliances used or usable in the manufacture of such explosives, whether then patented or not, or for which application might be pending; thereupon, in consideration of \$25,000 paid them, the said first parties sold, assigned, conveyed, and set over to the said second parties, their successors, and assigns—to the Repauno Chemical Company an undivided one-third, and to the Atlantic Dynamite Company an undivided two-thirds, in and to the said letters patent, and in and to all claims arising out of the infringement thereof, and also in and to all inventions and discoveries, joint and several, which had been or might thereafter be made by said first parties, relating in any way to explosive compounds and substances, whether patented or not, and in and to all letters patent which could or should be obtained in this or other countries therefor, agreeing for themselves, their heirs, executors, and administrators to execute all necessary papers connected therewith.

the correct view being the other way (*Paine v. Trask*, 56 Fed. 233, 5 C. C. A. 497; *Mayor v. American Cable Railroad*, 60 Fed. 1016, 9 C. C. A. 336). The case is not to be ruled by analogy with the recording of deeds for the alienation of real estate, which depends upon the effect of local statutes, where, as in Pennsylvania for instance, an exemplification of the record is expressly made evidence, "as valid and effectual in law as the original deeds themselves." 1 *Brightly's Dig.* p. 472, par. 74. Congress might have so provided, but the fact is that it has not done so, and that is the end of it.

But, even if the agreement here were properly proved, it would not be effectual to overcome the complainant's title. Assuming that an undertaking, such as it was, to assign all inventions and discoveries which should thereafter be made by Schrader and Penniman, in any way relating to explosive compounds and substances containing nitroglycerin, and to the machinery and appliances used or usable in the manufacture of the same, was broad enough to include a device of the character of that in suit, which is merely a machine for packing explosive gelatin, which may be doubted, and that it is not open to the charge, by reason of its generality, of being a mortgage on future inventive efforts of the parties, which is not favored (*Aspinwall Mfg. Co. v. Gill* [C. C.] 32 Fed. 697, 700), as it might well be regarded; even so, it was not such an instrument as is covered by the statute, and was not entitled, in consequence, to be put on record, and if not, it conveyed no notice of its terms to the complainant, who thus took title without regard to it. It is well established that the recording of an instrument not provided for by the recording acts conveys no notice. 24 *Am. & Eng. Encycl. Law* (2d Ed.) 24, 141; *Burck v. Taylor*, 152 U. S. 634, 14 Sup. Ct. 696, 38 L. Ed. 578; *Heister v. Fortner*, 2 Bin. (Pa.) 40, 4 *Am. Dec.* 417. And, no assignment of an unpatented invention being authorized or required to be recorded—unless it be an assignment on which a patent is to directly issue—an agreement to assign a patent not yet obtained is not within the statute, and recording it amounts to nothing. *Wright v. Randel* (C. C.) 8 Fed. 591, 599; *New York Paper Bag Co. v. Union Paper Bag Co.* (C. C.) 32 Fed. 783, 788; *Regan Vapor Engine Co. v. Pacific Gas Engine Co.*, 49 Fed. 68, 1 C. C. A. 169. Nor, therefore, is a certified copy of it evidence, even if, contrary to the views above expressed, such copy might be in other cases.

Independent of these considerations, and giving to the copy of the agreement the full force and effect contended for, it is claimed that whatever title or interest was thereby acquired by the Repauno Chemical Company or the Atlantic Dynamite Company is now vested in the complainants by sundry mesne conveyances and transfers. But the evidence as to this is not so complete as it might be, although not open to some of the objections made to it, which incline to be hypercritical; and I will not therefore go into it. It is sufficient to observe that, for the reasons given, the record of the agreement, which is now sought to be set up as proof of a possible outstanding title in others, was no notice to the complainants of its contents, and interposed no impediment to their taking title, as they did, through the assignment from

the executrix of the patentee, which thus invested them with the full and complete ownership.

This clears the way for the examination of the patent. Explosive gelatin, which it concerns, is put up for use in the form of cartridges about eight inches long and of varying thicknesses, the material being put through a so-called packing machine and turned out from the nozzle in a continuous sausage-like rope, which is cut up and inclosed in waterproof paper bags or skins, for convenience of use and handling. The gelatin has the consistency of putty, with a grain like brown sugar, and in the somewhat primitive type of machine known as the "Sundstrom," extensively employed at the time of the patent, the material was fed intermittently into a rectangular hopper, from the bottom of which it was forced through a nozzle by a horizontally revolving shaft and screw, the gelatin, on account of its sluggish character, being pressed down upon the screw by a platen or plunger, fitted to the hopper, and operated by hand, by a screw and lever, after the manner of the ordinary screw press. There were two serious objections to this, however. In the first place, each time after the hopper had been filled and exhausted, it was necessary to discontinue the operation, raise and remove the plunger—a slow and by no means simple matter—and, having refilled the hopper, resume the process again. And in the next place, owing to the low temperature at which the gelatin explodes, great care had to be exercised lest it should go off, as it easily might, under the heat generated by the pressure or delivery of it by the plunger, beyond the capacity of the packing screw to take. The object of the invention in suit was to obviate these difficulties; the operation being made continuous, the material being fed uninterruptedly into the unobstructed mouth of the hopper as fast as it is taken care of by the packing screw below and the pressure on it being at the same time automatically regulated and relieved by the screw-feed mechanism by which it is delivered. The hopper and packing screw with its nozzle and case are retained, but the hopper is in the form of an inverted cone, having interior converging ribs, within which is a centrally located, revolving, machine-driven shaft, weighted at the top, and provided with sectional blades or paddles, arranged spirally, and set at an angle to the plane of rotation, with a worm at the end, the shaft being rotated in the direction of their highest edge, and being loosely splined in its gears, so as to be free to rise and fall as required. The material being fed regularly into the mouth of the hopper, is carried downwards by the action of the revolving blades, and forced through the nozzle, by the packing screw below, to form a rope. And in case of any accumulation or clogging of the gelatin at the bottom of the hopper beyond the capacity of the packing screw to relieve, the condensation and back pressure so produced cause the blades, by reason of their angularity, to ride on the material, forcing the shaft upwards against the resistance of the weights at the top, which are adjusted to meet normal pressure only, the shaft being free to rise through its gears, and settling back again into place when the pressure is relieved. The delivery of the material is thus lessened and ultimately stopped, if the conditions persist, until

the packing screw is able to keep up with the supply, the continuity of the operation being preserved and made automatically safe.

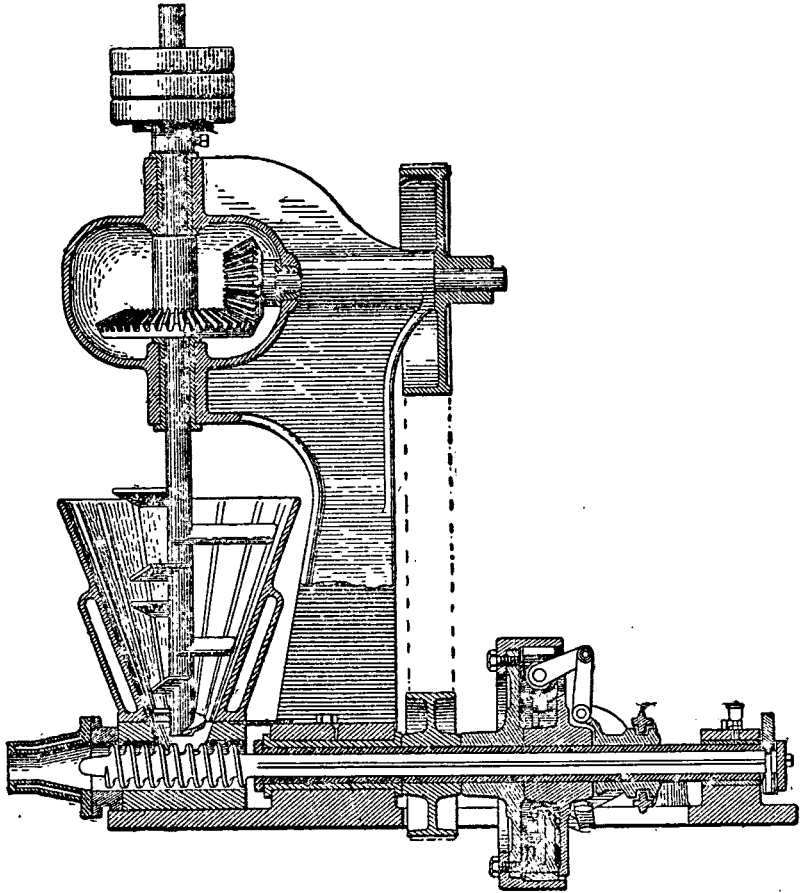

That there is nothing to anticipate this in the prior art is clear. The Sundstrom machine, which it supersedes, after ten or more years of continuous use, is the only device with which comparison is really to be made, being not only the best, but in fact the only one, of the kind which had been so far produced; but it offers nothing with which to compete. Its crude and primitive character, by contrast, requires but a glance. The hopper and the packing screw and nozzle, being essentials, are found in both, but are so improved upon and combined with new and different parts as to revolutionize the whole. Indeed, if there was nothing more than the change from the slow, complex, and interrupted operation of the one to the simple and continuous operation of the other, it would be enough to signalize the present device; while

with the added arrangement of feed mechanism, by which the dangerous condensation of the material at the bottom of the hopper above the packing screw is automatically obviated and relieved, the invention is made to stand out as one of decided, if not conspicuous, merit. By the old and superseded method, after a hopper full of material, laboriously worked down upon the packing screw by hand, by means of the screw press and plunger, had been disposed of, the plunger had to be screwed back to the top, the hinged bar, in which it hung, unlatched, the plunger withdrawn from the hopper, the hopper refilled, the plunger put back, the bar swung down into place and latched, and the process resumed, to be repeated in exactly the same slow way to the end. The touch of the operator also was the only thing relied on to gauge the pressure and not let it get too much. All this, however, is now done away with in the device in suit; the operator having merely to set the machine going, keep it supplied with material, which is readily fed into it from above, and watch the result.

It may be, as contended, that many, if not all, of the different parts of the machine, of similar form, and somewhat similarly, if not suggestively, combined and used, are to be found in various arts; and that, changing a feature here and another there, existing machines, however foreign to their original purpose, could be transformed into something of the kind which we have here. But that is not the test. Inventors are not held to the devising of new mechanical forms, or the discovery of hitherto unknown physical principles, but only to the new adaptation and application of those which are already at hand. Not that this is not to be desired, if able to be attained, but simply that it is not required. Neither, in the effort to anticipate, are existing devices to be manipulated and made over at will. The question is whether, having regard to what there has been in the past, new and beneficial results have been produced by means not before employed, amounting to inventive advance. And this is not met by evidence that, with the new light possessed, old devices might possibly be made over to do the same thing. Outside of the immediate art of the patent, the Heilmann Candy Machine, according to the defendant's expert, comes the nearest to being an anticipation, and if that cannot be said of it, it will not be necessary to discuss the rest. But the most cursory examination of it will suffice to convince that such is not the case. No doubt it shows a hopper, with a packing screw and nozzle below, through which the material is forced, to produce certain forms. But the material is pressed down upon the packing screw simply by means of a plunger or platen which feeds the hopper and is loaded with a weight suspended on a hinged bar or lever, on which it is movable to increase or lessen the force applied. This, while not so complicated or cumbersome as the plunger of the Sundstrom, is not much better, and is equally crude. It is possible that, with some slight modification, an effective machine for the packing of explosive gelatin could be made out of it, but not clearly of the character of that in suit. It is not enough that both have a hopper with a packing screw and nozzle, where the resemblance practically ends. The weighted plunger, suspended on its hinged lever bar, to press down the material upon the

packing screw, of the one, permitting at best, as it does, only the intermittent filling of the hopper, and except by dead pressure in no way regulating the feed, has nothing in common, either in form or function, with the revolving shaft of the patent, with its sectional blades, providing for continuous operation, and acting automatically to relieve dangerous congestion of the material above the packing screw. This is the real feature of the invention, although it is not, of course, to be taken out of its setting, and is so distinctive and useful that on it the claim to inventive novelty and the right to a patent may well be made to rest. The Heilmann not having stood the test, it is not necessary, as already intimated, to take up others, no better, if indeed so good. And much less will it be required to consider the numerous references, not offered before the examiner, nor explained by evidence, which were brought in for the first time at the argument, in supposed illustration of the state of the art, of which the court is expected to take judicial notice, as well as to understand, which, if permissible practice, is not to be encouraged.

It is said, however, that even if inventive novelty is shown, Schrader was not entitled to the merit of it, Payne or Sturtevant being the real inventor, one having originally suggested to Schrader the idea of the machine, and the other put into shape that which was so communicated to him. Schrader is dead, and unable to defend his position. But even without the benefit of his assistance, the evidence to the contrary is not of that clear and convincing character which is required to overthrow a patent. Payne's story is that, in 1889, while at work for the Atlantic Dynamite Company as lead burner and all-around mechanic, where Schrader was the general manager, he made drawings for changes in various machines, and among others, so far as he can remember, for the Sundstrom. He fixes the time by the blizzard of 1888, although the connection is not manifest, and his idea, as he says, was to use a perpendicular feed screw, in a round hopper, operating on the same principle as the packing screw, the feed screw shaft to be splined, so as to work up and down through the pulley, and to be held down in place by a hinged pressure-lever and weight at the top. He first brought this, according to his statement, to the notice of Mr. Lunn, who handed the drawings to Mr. R. S. Penniman, and he, in turn, passed them on to Schrader, after which the four met together and had a lengthy conference over them, Schrader, however, not considering them practical. The matter rested in that shape for 10 years, when in May, 1899, about the time that he was leaving the employ of the company to work elsewhere, he again called it to the attention of Schrader, showing him a sketch. This latter date, as we shall presently see, was almost a month after Schrader had taken drawings of his machine, in nearly completed shape, to Sturtevant at the Morris County Machine & Iron Works, so that nothing can be predicated upon any communication at that time, even if it were better substantiated than it is. And as to the earlier one in 1889, there is nothing for it, the same as for the other, but Payne's say-so. Lunn and Penniman, who for all that appears may still be living, are not called to verify it, as they should be, the defendants conceiving that this duty devolves up-

on the complainants, in order to contradict Payne, instead of on them to corroborate him; and the drawings, which are now produced by Payne, having been made by him for the occasion to illustrate his testimony. Moreover, not only does Payne qualify his statement, as to what occurred in 1889, in the way already indicated—saying, that, so far as he remembers, he made drawings, etc.—which makes it practically worthless, but, upon cross-examination, he is even less certain, finally declaring that he will not be positive that he made any such drawings, or that he submitted them to Lunn and Penniman, and through them to Schrader, unless he has their word for it. It is needless to say that if patents could be upset upon evidence of this character, they would be of little value.

Nor, rightly considered, is the part taken in the invention by Sturtevant more serious. Sturtevant was superintendent of the Morris County Machine & Iron Works, of Dover, N. J., where Schrader lived, and in the spring of 1899, as he testifies, Schrader brought to him at the works two pencil sketches of an improved machine for packing explosive gelatin. He and Schrader, according to his story, had been interested in getting up such a machine, and the drawings expressed Schrader's idea of it, and were turned over to him (Sturtevant) to devise a working machine, which he proceeded to do, the result being shown in certain drawings, in ink and pencil, which have been produced from among the old drawings of the company, and bear evidence of their authenticity, the dates upon them fixing the time as early in April. As the work progressed, Schrader and Sturtevant consulted together over it, Sturtevant submitting to Schrader for criticism his ideas with regard to it. But all the modifications and changes, departing from the original drawings of Schrader, are claimed by Sturtevant to have been of his designing, without suggestion or direction from Schrader, except the general one at the beginning to go ahead and get up a working machine, and except, also, as Schrader requested that some means be devised for cooling the lower part of the hopper, which resulted in the arranging of a water jacket. For all this, however, save only as there may be an incidental corroboration of some of it by the drawings, there is nothing but the unsupported testimony of Sturtevant as to what part of the work was his and what part was Schrader's which, without any intended reflection, the law regards as perilous by itself to destroy a patent (22 Am. & Eng. Encycl. Law [2d Ed.] 331, 332), which is emphasized in the present case; the patentee not being alive to contradict it. What is now claimed by Sturtevant, it may be, if the truth were known should, in fact, be attributed to Schrader, as the general and controlling features certainly are to be. Admittedly Sturtevant in all that he did was acting for Schrader to carry out and put his ideas into working shape. And while it is no doubt true that where suggestions made by another "go to make up a complete and perfect machine, embracing the substance of all that is embodied in the patent subsequently issued to the party to whom the suggestions were made, the patent is invalid, because the real invention or discovery belonged to another" (*Agawam Co. v. Jordan*, 7 Wall. 583, 603, 19 L. Ed. 177), where, on the other

hand, "a person has discovered an improved principle in a machine, manufacture, or composition of matter, and employs other persons to assist him in carrying out that principle, and they, in the course of experiments arising from that employment, make valuable discoveries, ancillary to the plan and preconceived design of the employer, such suggested improvements are in general to be regarded as the property of the party who discovered the original improved principle, and may be embodied in his patent as a part of his invention" (page 602 of 7 Wall. [19 L. Ed. 177]). "Common justice," as it is added, "would forbid that any partial aid rendered under such circumstances, during the progress of experiments in perfecting the improvement, should enable the person rendering the aid to appropriate to himself the entire result of the ingenuity and toil of the originator, or put it in the power of any subsequent infringer to defeat the patent, under the plea that the invention was made by the assistant and not the originator of the plan." Page 604 of 7 Wall. (19 L. Ed. 177). These observations apply with pertinence here. Even accepting all that Sturtevant testifies to, the predominant part in the invention clearly belongs to Schrader. A comparison of the drawings, of which he was admittedly the author, with those made up after them by Sturtevant shows that one is a mere amplification of the other, one being in sketch, where the other is in detail. A mouth was added to the hopper by Sturtevant for the convenience of loading, and a hollow shaft suggested to carry the shaft of the packing screw, the driving pulley being mounted on, and the shaft of the packing screw keyed to, it. A water jacket, about the lower part of the hopper, to control the temperature, was also devised at the instance of Schrader, as already stated. But these are incidentals merely, the essentials of the machine, outside of them, being found in the original ideas advanced by Schrader. Not only is the general collocation and arrangement of parts which there appear preserved in the drawings of Sturtevant, following them, but particularly the conical hopper and feed screw to match, with its two sectional blades and revolving shaft arranged to rise through its gear, which, as we have seen, is the feature of the invention. It is contended that Schrader does not show the shaft loosely splined. But Sturtevant does not venture to say this, and defendants' expert admits that it may have been so intended, the only difficulty, as he says, being that the lugs overlapping the gear above and below, which are shown, would conflict with the assembling and disassembling of the parts which, this being a sketch, is not to be taken as controlling. Around the shaft, moreover, is a sleeve carrying the gear, the only purpose of which is to allow of vertical motion, which, even if the rest were less clear than it is, must therefore be taken as provided for. It is also stated by Sturtevant that nothing was said by Schrader as to the shaft being weighted, and that the receptacle for weights, which appear in his (Sturtevant's) drawings, were of his own design, as was the change to the collar and separate weights which are found in the patent. But at the top of the shaft in the Schrader sketch are horizontal lines, which, while somewhat obscure because of being at the extreme edge of the paper, may well be accepted as standing

for this, no other purpose being conceivable for them, and if so, the hopper-like receptacle shown by Sturtevant, as well as the change to collar and weights which was subsequently adopted, is an immaterial variation. More important is it that, except as to its two upper blades, the feed screw in the Schrader sketch extends unbrokenly to the bottom, where in the patent all but the worm at the end are paddles. But even here the use of sectional blades is in part shown by Schrader, being repeated in exactly the same shape in the drawings of Sturtevant, and the extension of this idea, to whomsoever it is attributed, is a mere amplification or improvement, being simply more paddles. Under the most critical examination, therefore, the general plan, as well as the operative principle, of the machine of the patent, is clearly discernible in the drawing submitted by Schrader to Sturtevant, not only in rudiment but in practically completed conception, the work of the latter being merely a perfecting of the mechanical details, not going to the substance of the invention. Undoubtedly the modifications and changes so brought in contribute to the efficiency of the machine, but they do not go to its essence, leaving unaffected the right of Schrader to be considered the original and real inventor.

It is said, however, that machines of the exact form of the patent were subsequently constructed and sold by the Morris County Machine & Iron Works, the whole expense of patterns and everything being borne by them and the machines billed directly to purchasers, Schrader merely selling them and getting a commission, which is inconsistent, as it is urged, with the idea of his being the inventor. But while sales so made may have amounted to a public use, which would have defeated the patent, unless seasonably applied for thereafter, they do not necessarily negative the claim of Schrader to have originated the invention, nor overcome the evidence to that effect already alluded to. Even though machines were constructed from his drawings, after they had been put in shape by Sturtevant, he was none the less the inventor, and he saved his rights by the application for a patent which he subsequently successfully prosecuted. He did not give away his invention, in other words, and much less is it proved that his was not the original conception, because the Morris County Machine & Iron Works were allowed to construct and sell machines patterned after it, for which in each instance, as it is to be observed, it was he who obtained the purchaser. It is testified also by Phillips, the foreman of the shop under Sturtevant, a witness for the defendants, that the company, among other things, built gelatin packing machines for Schrader, and he identifies the drawings which are produced as those by which they were built, which he speaks of as Schrader's gelatin packing machines, the name by which they were evidently known to him; which hardly proves that Schrader was not the inventor of them. Indeed, without dwelling further upon this branch of the case, it may be dismissed with the remark that the evidence produced to refute the claim of Schrader goes the rather to confirm and strengthen it. It certainly does not overcome the presumptions which exist in his favor.

But while the invention itself is thus sustained, as well as the right of Schrader to the merit of it, there are some of the claims of the patent which unfortunately cannot be. The complainants rely on the first, second, third, fourth, fifth, sixth, seventh, eighth, and sixteenth,¹ the first four and the last, as it is said, being generic, and the rest specific. It is the so-called generic claims that do not meet the requirements. They express, it may be, the principle of the machine, or the purpose to be carried out by it, but a mere operative idea or principle cannot of course, be patented. *Union Match Co. v. Diamond Match Co.* (C. C. A.) 162 Fed. 148. The device here is a mechanical one, designed to accomplish certain practical results in the packing of explosive gelatin, and is necessarily confined to the specific means employed for doing so. This may in a measure be said to be indicated in the claims in question, but not, as it seems to me, to the extent that it should be. For instance, in the first claim, after specifying a packing screw and its case as the

¹“(1) In a machine for packing explosive gelatin the combination with a packing-screw and its case of automatically-regulated feeding mechanism for variably supplying material to said case in response to variations in the quantity consumed by said screw, substantially as described.

(2) In a machine for packing explosive gelatin the combination with a packing-screw and its case of a hopper, means for feeding material therefrom to said screw, and means whereby the amount fed to said screw will be automatically varied in response to variations in the quantity consumed by said screw, substantially as described.

(3) In a machine for packing explosive gelatin the combination with a packing-screw and its case of a hopper, means within the hopper for forcing material therefrom to said screw, and means whereby the pressure upon the material in the hopper will remain constant during the operation of the machine, regardless of the quantity consumed by said screw, substantially as described.

(4) In a machine for packing explosive gelatin the combination with a packing-screw and its case of a hopper, means within the hopper for forcing material to the packing screw, and means for regulating the pressure upon the material, substantially as described.

(5) In a machine for packing explosive gelatin the combination with a packing-screw and its case of a hopper, a vertically-movable shaft suspended therein, horizontal blades carried by said shaft having downwardly-inclined faces, and means for rotating said shaft, substantially as described.

(6) In a machine for packing explosive gelatin the combination with a packing-screw and its case of a hopper, revoluble blades within said hopper having faces angular to their plane of rotation, and means whereby said blades are free to rise during their rotation, substantially as described.

(7) In a machine for packing explosive gelatin the combination with a packing-screw and its case of a hopper, a vertical shaft suspended therein having blades angular to a horizontal plane projecting radially therefrom, said shaft being free to rise in suitable bearings, an adjustable weight on said shaft, and means for revolving said shaft and screw, substantially as described.

(8) In a machine for packing explosive gelatin the combination with a packing-screw and its case of a frame, a hopper, a longitudinally-movable shaft suspended therein, horizontal blades carried by said shaft having downwardly-inclined faces, a gear splined to said shaft supported by said frame, and means for rotating said gear, substantially as described.

(16) In a machine for packing explosive gelatin the combination with a packing-screw and its case of a hopper communicating with said case, horizontally-revoluble blades suspended in said hopper, and adapted to force material therefrom to said screw, and means permitting the automatic rising of said blades when the material offers sufficient resistance to the rotation thereof, substantially as described.”

first member of the combination declared for, the second member is an "automatically regulated feeding mechanism for variably supplying material to said case in response to variations in the quantity consumed by said screw." This is not a mechanical means, but a function, or rather it is an attempt to indicate the means by the function to be performed by it. It may be the operative principle of the machine, comprising its utility, but the invention cannot be regarded as residing in the discovery of the beneficial principle involved, but in the mechanism by which advantage is had of it. So in the second claim, after specifying the packing screw and hopper, the other elements designated are "means for feeding material therefrom to said screw, and means whereby the amount fed to said screw will be automatically varied in response to variations in the quantity consumed by said screw," which again merely describes the means to be employed by their functions. And the same is true of the other claims, of all of which it may be said that they attempt to monopolize the abstract result sought to be attained instead of the concrete mechanism devised for doing so. It is no doubt difficult to define the distinction between a practically operative mechanism and its function. Paper Bag Patent Case, 210 U. S. 405, 422, 28 Sup. Ct. 748, 52 L. Ed. 1122. And it may be permissible at times to claim, as an element of a combination, "means," otherwise unspecified, for effecting a certain mechanical result, this being particularly the case in inventions of a broad and primary character. But without undertaking to decide just when it may or may not be employed, it is enough to say that, for the reasons given, it is not a sufficient designation here.

The question of infringement remains and must be made out by satisfactory evidence as a part of the complainants' case, irrespective of the effect to be given to the denial in the answer; an answer under oath not having been called for. It comes very near to being admitted, however, in the complaint by the defendants, that a neighbor, the Climax Powder Company of Emporium, Pa., where the defendants' works are located, was allowed for a number of years to use one of these machines, without being interfered with, the defendants, as it is suggested, being thereby led to believe that they could do so also, estopping the complainants from now calling this in question. But without dwelling upon this, or undertaking to discuss the alleged estoppel, which of course cannot be sustained, there is other evidence from which infringement sufficiently appears. On Sunday, September 10, 1905, Mr. R. M. Hunter, the complainants' expert, investigating the subject on their behalf, visited the works of the defendants at Emporium, and saw and made a sketch of a machine which was there set up, and which was, in all respects, of the character described in those claims of the patent which have been declared valid. It is said that the shop to which he went is not sufficiently identified, having been pointed out to him by a young man who is not produced, nor his name given; his declarations with regard to it amounting to hearsay. But on cross-examination Mr. Hunter described the location, with reference to the town of Emporium and its surroundings, of the place to which he was conducted, and if it did not conform to the facts, or

apply to the defendants' works, it was very easy to disprove it, and they would be swift to do so. It is also said that the shop was shut and the works not running, and that although Mr. Hunter could only see the machine imperfectly through the windows, and could not possibly tell how it operated, he has undertaken to describe it in detail, even going so far as to give its interior structure. But according to Mr. Hunter, although outside of the building, he got within a few feet of the machine, and had a front as well as a side view of it, in one position also being able to look down into the hopper and see the blades, and, the nozzle happening to be off, he saw the packing screw and the tubular character of the block which it turned in. His opportunity to observe what he describes would therefore seem to have been ample. The only possible question is whether he could tell that the shaft was loosely splined, so as to be free to rise and fall, which of course is vital. But there was a weight at the top, which had no purpose otherwise, besides which, the shaft extended up through and beyond the gear, and above and below it on the shaft was a groove or keyway for the spline, from which a spline is to be inferred, there being no other use for it. And as was said above, with regard to the identity of the works which Mr. Hunter visited, it was open to the defendants to contradict this evidence, if not true, and show the exact character of the machine which they used, if this does not correctly describe it, which, not having been done, it may well be accepted *prima facie*.

There was no proof that the complainants' machines were marked as required by the statute, and issue as to this having been made in the answer, and no notice having been shown to have been otherwise given, the right to an account is contested. But the bill was notice, and the complainants do not ask for anything beyond that, and to this at least they would seem to be entitled. *American Caramel Co. v. Mills* (C. C. A.) 162 Fed. 147.

Let a decree be drawn sustaining the fifth, sixth, seventh, and eighth claims of the patent, but not the others relied on, and holding them infringed, and also awarding an injunction and directing an account, but limiting it to infringement since the filing of the bill, with costs.

PREST-O-LITE CO. v. AVERY PORTABLE LIGHTING CO. et al.

(Circuit Court, E. D. Wisconsin. September 15, 1908.)

1. COURTS—JURISDICTION OF FEDERAL COURT—SUIT BY ASSIGNEE.

A bill by a corporation alleged that one of the defendants, who had made an invention and applied for a patent therefor, by a written instrument assigned a two-thirds interest therein and in the right to the patent therefor to two other persons; that the three organized complainant corporation, and thereupon sold their rights to the corporation, receiving in payment its capital stock; that complainant, under the management of such three persons, engaged in the manufacture of the invention, but that such defendant subsequently sold his stock therein, and on the issuance of the patent caused the same to be assigned to another corporation, which was made defendant, and which had engaged in the manufacture of the patented article; that the two other persons had assigned their equitable interest in the invention and patent to complainant. The bill

prayed for an accounting of profits, an injunction to restrain defendants from manufacturing the patented article, and that they be required to assign the patent to complainant. *Held*, that the purpose of the bill was, not the specific enforcement of the written assignment made by defendant, but to charge him as trustee *ex maleficio* on the ground of fraud, and that the case was not, therefore, within the provisions of section 629, Rev. St. (U. S. Comp. St. 1901, p. 503), relating to suits by assignees to recover the contents of a chose in action.

2. SAME.

The individual defendant, having been a director and a salaried officer of complainant at the time he assigned the patent, was also chargeable as trustee by virtue of such relationship, regardless of the written assignment; and, diverse citizenship appearing, the suit was maintainable in a federal court to require an accounting and to compel a transfer of the patent.

[Ed. Note.—Diverse citizenship as a ground of federal jurisdiction, see notes to *Shipp v. Williams*, 10 C. C. A. 249, and *Mason v. Dullaghan*, 27 C. C. A. 298.]

3. PATENTS—INFRINGEMENT—SUIT BY EQUITABLE OWNER AGAINST PATENTEE.

A suit for infringement of a patent may be maintained by the equitable owner against the patentee.

4. SAME—MULTIFARIOUSNESS OF BILL.

A bill by the equitable owner of a patent against the holder of the legal title, to compel a transfer of the patent and for infringement, is not multifarious.

[Ed. Note.—For cases in point, see *Cent. Dig.* vol. 38, Patents, § 518.]

In Equity. On demurrers to bill.

The averments of the bill are substantially as follows: That the complainant is a corporation organized and existing under the laws of the state of Indiana, having its principal office at Indianapolis, Ind., and being a citizen of that state. The defendants are alleged to be citizens of the state of Wisconsin, and the alleged infringements to have taken place within the Eastern district of Wisconsin. That prior to October 17, 1904, the defendant Avery invented a new and useful improvement in gas tanks for the storing of acetylene gas. That on the 3d of September, 1904, Avery produced and exhibited a complete gas tank, embodying his invention in perfected commercial form, which he was about to put upon the market, and induced James A. Allison and Carl G. Fisher to enter into a certain written agreement, which is attached to the bill, by which, among other things, said Avery assigned to Allison and Fisher an undivided two-thirds interest in such invention and in the right to letters patent therefor, for which Avery had already applied; and by such contract it was further agreed that a corporation should be organized for the purpose of manufacturing, using, and vending such invention throughout the United States, and that all patents that might be thereafter obtained in the further development and perfection of said device should be transferred to said corporation. That pursuant to such written contract the complainant corporation was organized on the 6th day of September, 1904. Avery agreed to devote to and give said business his entire personal attention and experience, and in consideration therefor Allison and Fisher agreed that Avery shall be paid by said corporation a salary of \$150 per month, and that such salary shall be increased from time to time as said business may justify. That Avery became a stockholder and director, and also the secretary, of said corporation, and entered into its employ upon a salary. The manufacture of the patented device was undertaken by said corporation, and a profitable business resulted. That on October 17, 1904, Avery applied for letters patent for such invention. That on the 3d day of December, 1904, the stockholders of said complainant corporation, including Avery, on motion of Avery, authorized and directed the directors of said company to purchase of Avery, Fisher, and Allison the letters patent theretofore applied for and to be granted for said invention, for the sum of \$10,000, to be paid for by capital stock

of complainant company; said stock to be issued in equal amounts to Avery, Allison, and Fisher. That thereupon such capital stock was issued accordingly, and received and accepted by the parties as full payment for their several interests in said invention and the right to letters patent thereon. That Avery continued with the complainant company, which manufactured and marketed the devices covered by said invention. That said Avery received for his services from said corporation a salary, in addition to dividends declared by said company upon the capital stock thereof. That Avery, Allison, and Fisher were the officers and directors of said complainant company, and the conduct of the applications for letters patent was left entirely to Avery, by virtue of the trust and confidence reposed in him as an officer of such corporation. That on the 27th day of March, 1906, letters patent of the United States, numbered 816,059, were issued to said Avery for such invention. That on the 19th day of May, 1906, Avery sold his stock in the complainant corporation to Allison and Fisher for the sum of \$33,333. That on the 2d day of May, 1906, said Avery, while still in the employ of, and an officer of, the complainant corporation, executed an assignment of such letters patent in writing to one George L. Wilkinson, who was one of the attorneys for said Avery in the prosecution of said application. That said assignment to said Wilkinson was without consideration, and with full knowledge of the facts hereinbefore set forth. That thereupon Avery left Indianapolis, Ind., where complainant's business was being conducted, and proceeded to Milwaukee, Wis., where, in conjunction with certain other parties, on the 29th day of March, 1906, he caused to be organized the defendant corporation, for the purpose of engaging in the manufacture and sale of the device covered by said letters patent. That practically all of the stock of the defendant corporation was issued to Edgar C. Avery, the father of the defendant Avery. That Wilkinson made an assignment to the defendant corporation of the said letters patent, which purported to be made on the 5th day of June, 1906. That thereupon the defendant corporation proceeded to manufacture the patented device, and had sold such patented gas tanks in large quantities, causing irreparable injury to, and amounting to an infringement of the rights of, the complainant. That complainant duly demanded the assignment of said letters patent from said Avery to the complainant, which demand was refused by Avery. That the value of said letters patent exceeds the sum of \$5,000. The citizenship of Allison and Fisher is not alleged. It is further averred that Allison and Fisher by an instrument in writing did assign to complainant an undivided two-thirds interest in and to the invention and letters patent therefor, with all claims or demands, either in law or equity, for any damages or profits that have accrued or may accrue on account of infringement by defendants. The prayer is for an accounting of profits; an injunction restraining the defendants from the manufacture, use, or sale of the patented improvement; that the assignment by Avery to Wilkinson, and by Wilkinson to the defending corporation, be adjudged fraudulent, and be rescinded and set aside; that Avery and the defending corporation be compelled to assign to the complainant his interest in such invention and letters patent; and also an injunction to prevent the defendants from making further transfers or assignments of such letters patent or any interest thereunder.

Each of the defendants interposed a demurrer. The demurrers challenge the jurisdiction of the court because the complainant seeks to maintain this action as the assignee of one James A. Allison and Carl Fisher, claiming that said complainant acquired certain rights from Allison and Fisher, which they had theretofore acquired from the defendant Avery, and had by written assignment transferred to the complainant; that complainant is seeking by virtue of such assignment to establish and recover rights and things that are the contents of a chose in action; that said bill of complaint fails to show the citizenship of said Allison and Fisher; that the assignors of complainant could not have maintained this action in this court, and therefore the jurisdiction fails by virtue of section 629, Rev. St. (U. S. Comp. St. 1901, p. 503); second, that said bill of complaint is multifarious, in that it unites an action for specific performance and a cause of action for infringement; and, third, that the bill of complaint does not state facts sufficient to entitle the complainant to any equitable relief.

Bartlett, Brownell & Mitchell and Carl F. Geilfuss (Keyes Winter, of counsel), for complainant.

Ferdinand A. Geiger (Walter H. Chamberlin, of counsel), for defendants.

QUARLES, District Judge (after stating the facts as above). The first ground of objection is predicated upon section 629, Rev. St. (U. S. Comp. St. 1901, p. 503), which denies to the Circuit Court jurisdiction in a case "to recover the contents of any promissory note or other chose in action in favor of any assignee, or of any subsequent holder, if such instrument be payable to bearer, or be not made by any corporation, unless such suit might have been prosecuted in such court to recover the contents if no assignment or transfer had been made." If the main purpose of the bill of complaint were to secure the specific performance of the agreement of September 3d, the contention that it would fall within the purview of section 629, Rev. St., would be entitled to serious consideration. The language of this enactment has received a broad construction by the courts; but we do not feel called upon to prosecute this inquiry, because we do not agree with defendant's construction of the complaint. The agreement of September 3d is an important link in the chain of circumstances recited in the bill; but the ground of recovery and the equities of the complainant do not spring from such contract, but rest upon the alleged fraud of the defendants.

Fairly construed, this bill is an appeal to a court of equity to impose upon the defendant Avery a trusteeship, by means of which the court by its own processes may work out a righteous result. There are two grounds presented in the complaint, either of which would warrant the court in treating Avery as a trustee *ex maleficio*, independent of the written contract of September 3d. Avery transferred an equitable two-thirds interest in his invention to Allison and Fisher. Avery, Allison, and Fisher sold the entire equitable title to the invention to the complainant for \$10,000 of its capital stock before the letters patent were issued. They accepted such stock as a full and complete equivalent, and thereby the invention and the right to letters patent thereon became corporate assets. Such an oral agreement is not within section 4898, Rev. St. (U. S. Comp. St. 1901, p. 3387), and not within the statute of frauds, and may be specifically enforced in equity upon sufficient proofs. *Dalzell v. Dueber Mfg. Co.*, 149 U. S. 315, 320, 13 Sup. Ct. 886, 37 L. Ed. 749. The law is that, having made such an oral transfer, the complainant acquired an equitable interest, and Avery, holding the legal title, became a trustee. *Somerby v. Buntin*, 118 Mass. 279, 19 Am. Rep. 459; *Blakeney v. Goode*, 30 Ohio St. 350, 360.

In *Littlefield v. Perry*, 21 Wall. 205, 227, 22 L. Ed. 577, the court say:

"The contest is now between an assignor in equity and his assignee. A court of equity will in such a case give the same legal effect to an equitable title that it would to one that was legal."

Second. Avery became a director and officer, as well as a salaried employé, of the complainant corporation. Upon the plainest prin-

principles he is chargeable as a trustee by virtue of such relationship. *Consolidated Vinegar Co. v. Brew*, 112 Wis. 610, 612, 88 N. W. 603. Instead of protecting the interests of the complainant and his associates, as he was bound to do, it is averred that on the 2d day of May, 1906, he assigned and transferred the letters patent to his attorney Wilkinson. On May 19, 1906, he sold his stock in complainant corporation to Allison and Fisher for \$33,000, and then proceeded to appropriate the only asset that the corporation had, and to manufacture and sell the patented device in competition with complainant. If the averments of the bill, which are admitted by the demurrers, be true in fact, Avery has greatly abused his trust, in such a way that an accounting is absolutely necessary to protect the rights and equities of the complainant. This is the peculiar province of a court of equity; and, on the face of the bill, diverse citizenship appearing, the court has jurisdiction to entertain the case, which rests, not upon a written contract, but upon the fraud of the defendant. *Victor Co. v. The Fair*, 123 Fed. 424, 61 C. C. A. 58. Under the averments of this bill there can be no doubt that a court of equity should intervene to compel a transfer of the letters patent to the complainant, although there was no written agreement on the part of the defendants. *Pontiac Knit Boot Co. v. Merino Shoe Co.* (C. C.) 31 Fed. 286; *Stark v. Starr*, 73 U. S. 402, 419, 18 L. Ed. 925; *Consolidated Vinegar Co. v. Brew*, 112 Wis. 610, 612, 88 N. W. 603.

I am also of opinion that the jurisdiction may be sustained upon another ground. The bill charges an infringement by the inventor and prays for an injunction. It seems that such use by the inventor amounts in law to an infringement. If so, jurisdiction is conferred by the patent law of the United States. *Littlefield v. Perry*, supra; *Wooster v. Crane*, 147 Fed. 515, 77 C. C. A. 211; *Leslie v. Wm. Mann Co.* (C. C.) 157 Fed. 236.

The bill is not multifarious. The argument of counsel is that the two causes of action, the one for specific performance and the other for infringement, are incongruous, as the one is dependent upon the other, and the complainant is not entitled to damages for infringement until it establishes its right to be invested with the title. But in *Littlefield v. Perry*, 21 Wall. 206, 226, 22 L. Ed. 577, the court say:

"Courts of equity in proper cases consider that as done which should be. If there exists an obligation to convey at once, such courts will oftentimes proceed as if it had actually been made."

In the maze of conflicting decisions as to what is the test of multifariousness, we find one proposition concerning which the courts seem to be agreed—that a bill is not multifarious because it includes several causes of action, if they grow out of the same transaction. If all the defendants are interested in the same right, and the relief against each is of the same general character, the bill may be sustained. *Barcus v. Gates*, 89 Fed. 783, 791, 32 C. C. A. 337 (decided by the Court of Appeals of the Fourth Circuit); *Story's Eq. Jur.* § 796; *Swihart v. Harless*, 93 Wis. 211, 215, 67 N. W. 413.

For these reasons, both demurrers will be overruled, with leave to defendants to answer by the November rule day, if they shall be so advised; otherwise, judgment to pass upon the demurrer.

F. B. VANDEGRIFT & CO. v. UNITED STATES.

(Circuit Court, E. D. Pennsylvania. July 28, 1908.)

No. 54.

1. CUSTOMS DUTIES—CLASSIFICATION—RAMIE SLIVER—SIMILITUDE.

Ramie sliver is not dutiable as an unenumerated manufactured article, under Tariff Act July 24, 1897, c. 11, § 6, 30 Stat. 205 (U. S. Comp. St. 1901, p. 1693), but as cotton sliver by similitude, under section 1, Schedule I, par. 302, 30 Stat. 175 (U. S. Comp. St. 1901, p. 1655).

2. SAME — SIMILITUDE CLAUSE—PREFERENCE OVER PROVISION FOR UNENUMERATED ARTICLES.

In a case in which the similitude clause in Tariff Act July 24, 1897, c. 11, § 7, 30 Stat. 205 (U. S. Comp. St. 1901, p. 1693), is applicable, the rate determined thereby is to be preferred to that fixed by section 6, 30 Stat. 205 (U. S. Comp. St. 1901, p. 1693), relating to unenumerated articles.

On Application for Review of a Decision by the Board of United States General Appraisers.

Curie, Smith & Maxwell (W. Wickham Smith, of counsel), for importers.

Jasper Yeates Brinton, Asst. U. S. Atty. (J. Whitaker Thompson, U. S. Atty., on the brief), for the United States.

J. B. McPHERSON, District Judge. This is an appeal from the decision of the Board of General Appraisers classifying ramie sliver for duty under paragraph 302 of the tariff act of 1897 (Act July 24, 1897, c. 11, § 1, Schedule I, 30 Stat. 175 [U. S. Comp. St. 1901, p. 1655]) by similitude to cotton sliver. The case has been submitted upon the decision of the board, both parties conceding the findings of fact to be correct. The only question in dispute is the soundness of the conclusion drawn from such findings. The opinion of the board is as follows:

"This merchandise consists of ramie fiber drawn out in the form of sliver. It was assessed for duty at the rate of 45 per cent. ad valorem under the provisions of Tariff Act July 24, 1897, c. 11, § 1, Schedule J, par. 347, 30 Stat. 182 (U. S. Comp. St. 1901, p. 1664), as a manufacture of vegetable fiber, and is claimed to be dutiable under various provisions of the tariff act, no one of which we deem applicable.

"The merchandise is in all respects the same as that the subject of G. A. 5,822 (T. D. 25,710). At the hearing in the case a sample of the merchandise was submitted to the witnesses, and they identified the article as the same as that the subject of the decision. We find from the record samples and testimony taken in these cases that the merchandise, the subject of these protests, consists of ramie sliver. We hold, upon the authority and in accordance with G. A. 5,822, supra, that it is properly dutiable at the rate of 45 per cent. ad valorem, by similitude to cotton sliver, under the provisions of paragraph 302 of the said act. Inasmuch as the right rate of duty was assessed, the decisions of the collector as to the rate and amount of duty are affirmed, and the protests are overruled."

The previous opinion (In re Albert Eckstein et al., G. A. 5,822), to which reference is made, was chiefly concerned with the position then urged by the importers, namely, that the merchandise should be classified by similitude to "flax, hackled," under paragraph 325, or to

"hemp, hackled," under paragraph 327, while the only position now contended for is that it should be classified under section 6, as an article manufactured in whole or in part not otherwise provided for, and that duty should be imposed at 20 per cent. Nevertheless, the facts found in the Eckstein Case are necessary to the understanding of the present controversy, and accordingly the opinion there rendered is now quoted in full:

"This merchandise is invoiced as 'ramie,' of different colors and designations, and as 'ramie sliver.' In the vastly greater number of invoices it is designated as 'ramie sliver.' It consists of long ribbons or ropes of ramie fiber lying parallel, in lengths from a few feet to a hundred yards or more, dyed green, black, and a variety of colors, in others ecru or unbleached, and in others bleached. It was assessed for duty at the rate of 45 per cent. ad valorem as ramie roving or sliver, dutiable by similitude to cotton roving or sliver, which is specifically provided for under the provisions of paragraph 302 of the tariff act of July 24, 1897, which, in so far as pertinent, reads:

"'302. * * * Cotton * * * sliver or roving, 45 per centum ad valorem.

"A number of claims were made by protestants, but at the hearing their counsel limited his claims in the following language:

"The importer rests his claims on paragraph 325, for flax, hackled, and paragraph 327, for hemp, hackled, contending that ramie is one of the varieties of hemp, and, as the importations will be proven to be in hackled condition, that this paragraph 327 literally covers and provides for it; contending, further, that, if the article must be classified by similitude, its closest similitude is to either one of these two substances in paragraphs 325 and 327, and its closest of all similitudes to paragraph 325.'

"Paragraph 325 reads:

"'325. Flax, hackled, known as "dressed line," three cents per pound.'

"Paragraph 327 reads:

"'327. Hemp, and tow of hemp, twenty dollars per ton; hemp, hackled, known as "line of hemp," forty dollars per ton.'

"Another pertinent paragraph, in our opinion, is paragraph 347, which, in so far as pertinent, reads:

"'347. All manufactures of * * * ramie * * * not specially provided for in this act, 45 per centum ad valorem.'

"Much testimony was adduced at the hearing, and briefs submitted by counsel for both sides. Two questions are raised, one of fact and the other of law. First, it is contended by counsel for the importers that the merchandise is not 'sliver,' it not having progressed in the stages of manufacture to the point whereat merchandise is so known. Much stress was laid at the trial and in the briefs upon the different processes in the manufacture of various fibers whereby sliver is produced, with the purpose of supporting or rebutting the contention that this merchandise had reached that point in its manufacture known, or corresponding to what is known, as 'sliver.'

"We are of opinion that this article is ramie sliver.

"The manufacture of ramie is yet in its infancy, and machinery for that manufacture is yet imperfect. Upon the whole, from the testimony and the authorities, it unquestionably appears that the machinery best adapted for the manufacture of ramie fiber is that used for the manufacture of linen or flax. Undoubtedly ramie noils are used in cotton and woolen manufactories, but the machinery best adapted to the treatment of the ramie fiber, as an independent fiber, and its manufacture into thread or its spinning into yarns and weaving into cloth, is the flax or linen machinery.

"In determining the status in the processes of manufacture of a particular fiber, it is not necessary that it should have gone through all the processes of manufacture, or the same processes that another fiber has undergone in order to reach the same status. There are cotton slivers, wool slivers, flax slivers, ramie slivers, and slivers made from other fibers, each of which is a fiber sliver, unquestionably such, and each may have been subjected to a different number of processes of manufacture and different kinds of processes. This must unquestionably appear to be true in view of the fact that sliver

of the same fiber—for example, flax sliver—is produced by different processes and steps of manufacture. Thus we have flax sliver made from the line of flax, and flax sliver made from the tow of flax, each of which has undergone different processes of manufacture, but the product is called 'flax sliver'; so that it is not at all important in the determination whether or not a particular fiber has been brought to the status known as 'sliver' that it should have undergone certain processes of manufacture.

"In our opinion, 'sliver,' as the word implies, is a term used to express a condition of fiber. The term in its signification means something cut or divided into long, thin pieces or slivers. The importers introduced four witnesses in support of their contention that in ramie and flax manufacture the product did not become sliver until it had passed over the drawing machines. Three of these witnesses were importers of this article and parties hereto, and one a gentleman financed by one of the importers. Their testimony does not seem to be supported either by the natural signification of the word 'sliver' or by the authorities upon the subject.

"In the process of flax manufacture, sliver is produced after the flax has gone through (1) pulling of the plant; (2) rippling, which is separating the bolls from the stems; (3) retting, which is steeping or watering with a view to decomposing the gummy substance which binds together the outer membranes and the inner stalk; (4) scutching, by which the woody stalk is broken and threshed out, the long fibers called 'line flax' separated, and the short fibers called 'tow' removed; (5) hackling, a process by which the fiber is split to the finest possible condition and in which other fibers are eliminated, also called 'tow'; (6) spreading. By going through the spreading process over the spreadboard the fiber is drawn out into long ribbons or ropes, and thereby becomes 'sliver.' This sliver is reduced in fineness or size by being run through several drawing frames. The drawing frames do not make, but reduce, sliver. Sliver is made by the spreadboards. Sliver is also produced by running tow of flax through the hackling machine. In each case, it is a long ribbon, precisely similar, excepting the difference in fiber, to this merchandise, and excepting possibly in the variety of sizes of the sliver as it comes off the spreadboards.

"The witnesses adduced testified that it was sliver immediately after it left the spreadboard, and did not become such until it went through the drawing frames, and for that reason this merchandise, which they asserted had not been through the drawing frames, was not sliver. The recognized authority upon this subject, and perhaps the standard both in this country and of Europe, is the work entitled 'Posselt's Textile Library,' from volume 5 of which, at page 199, we quote the following:

"'Spreading. * * * The object of spreading is to produce a sliver out of the bunches of dressed and sorted flax, as is done in worsted spinning by means of the preparer.'

"And on page 200:

"'As previously mentioned, the bunches of flax spread on the feeding table of the spreadboard are stretched or drawn out by means of two pairs of rollers, called "feed rollers" and "delivery rollers," and are mixed in a solid, continuous sliver by means of the gills of the fallers. Out of each one of the six bunches of hackled flax fed into the spreadboard we find only a single (and proportionately thin) sliver leaving. This sliver is caught by two conductor rollers situated in front of the machine, which deliver it into cylindrical cans (sliver cans) placed in front to receive it. Each yard of sliver so delivered is measured previously to its delivery in the sliver can and registered by a simple arrangement.'

"And at page 201:

"'Before continuing the explanation of the further processes the sliver on leaving the spreading board is subjected to, we must mention another process, by means of which a sliver is also produced.'

"Here follows a description of producing sliver from tow upon a carding machine, after which the same authority continues on page 203:

"'Drawing. So far as we have explained, the production of the first sliver or foundation of the future yard, either for the line by means of the spreadboard or for tow by means of the carding engine. The next machine which

either sliver is subjected to for the purpose of still further increasing the fineness and uniformity of the sliver is the drawing frame. Both fibers (line or tow) are from now treated by similar processes.'

"Thus it appears upon this unquestionable authority that 'sliver' is a technical designation of the condition of the fiber as soon as it is run out into long ribbons and before it goes upon the drawing frame. This perfectly comports with the natural meaning of the word. It will be noticed, in passing, that the flax line and the hemp line is the flax or hemp in the natural lengths of the fiber as they come from the field and are scutched, being but a few feet in length, the natural length of the fiber, and before they go over the spreadboard or undergo further processes which extend them into the long strings or ropes, hundreds of yards in length, in which condition it is known as sliver; that this article has undergone a process which draws it into the long ropes or ribbons, and is therefore certainly not properly comparable with line of flax or hemp line, so far as the processes of manufacture are concerned, which latter have not yet undergone these processes.

"The terms, 'dressed line,' applied to flax, and the 'line of hemp,' are misleading, for both designate bundles of flax or hemp fibers the natural lengths of such only—in no case being over a very few feet in length.

"We are, therefore, of the opinion, and find upon the question of fact here presented, that this merchandise is unquestionably, as invoiced in the great majority of cases, ramie sliver.

"The tariff act of 1897 in no place names ramie as a dutiable commodity, except as a manufacture of that fiber. In this connection it is well to observe the difference between a manufacture of ramie and ramie manufactured.

"Paragraph 347, quoted, provides for manufactures of ramie not elsewhere specially provided for. Paragraph 330 provides for threads, twines, or cords made of ramie. Paragraph 331 provides for single yarns in the gray made of ramie. Aside from these provisions none occur in the tariff act, where ramie is specifically mentioned; at least it is not mentioned otherwise than in the condition of a manufactured article.

"The first question that arises, therefore, is whether or not this merchandise falls within any of these provisions. We are of the opinion that it does not. Aside from the distinction drawn between ramie manufactured or ramie advanced in manufacture, which may be admitted for the present, it is not a manufacture of ramie. That it is not ramie thread or yarn is evident. It would seem from the decisions that it is not a manufacture of ramie. The record is clear that the uses to which these importations are devoted are for subsequent manufacture into yarn and fabrics. We think this their chief use, though incidental uses for manufacture into hat bands may also exist. In *Seeberger v. Castro*, 153 U. S. 32, 14 Sup. Ct. 766, 38 L. Ed. 624, the Supreme Court of the United States, in passing upon what constituted the manufacture of an article as distinguished from the article manufactured, stated (the subject of discussion being the clippings and pieces of cigars not fit for use as imported, but which were subsequently to be manufactured into cigarettes and smoking tobacco):

"In *Lawrence v. Allen*, 7 How. 785, 12 L. Ed. 914, the process of manufacture was defined to be "making an article either by hand or machinery into a new form, capable of being used and designed to be used in ordinary life." A like view of what constitutes an article of manufacture has been previously announced by the Court of King's Bench. "The word 'manufacture' has been generally understood to denote * * * a thing made which is useful for its own sake and vendible as such," etc. *Rex v. Wheeler*, 2 B. & A. 347.'

"So in *Erhardt v. Hahn*, 55 Fed. 273, 5 C. C. A. 99, the United States Circuit Court of Appeals said:

"It has been repeatedly decided under the tariff acts that where an article has been advanced through one or more processes into a completed commercial article, known and recognized in the trade by a specific and distinctive name other than the name of the material, and is put into a completed shape, designed or adapted for a particular use, it is deemed to be a manufacture.'

"Citing *Hartranft v. Wiegmann*, 121 U. S. 609, 7 Sup. Ct. 1240, 30 L. Ed. 1012. In the last-cited case the Supreme Court of the United States said,

speaking of certain shells, which were held not manufactured by reason of certain work done upon them:

"They had not been manufactured into a new and different article having a distinctive name, character, or use from that of the shell. The application of labor to an article, either by hand or mechanism, does not make the article necessarily a manufactured article, within the meaning of that term as used in the tariff laws. * * * Cleaning and ginning cotton does not make the resulting cotton a manufacture of cotton. * * * In *Frazer v. Moffitt* (C. C.) 20 Blatchf. 267, 18 Fed. 584, it was held that hay pressed in bales, ready for market, was not a manufactured article, though labor had been bestowed in cutting and drying the grass and baling the hay. In *Lawrence v. Allen*, 7 How. 785, 12 L. Ed. 914, it was held that India rubber shoes made in Brazil by simply allowing the sap of the India rubber tree to harden upon a mold were a manufactured article, because it was capable of use in that shape as a shoe, and had been put into a new form capable of use and designed to be used in such new form."

"These decisions amply support the proposition that, in order to constitute a manufactured article, the processes of manufacture devoted to it must be so far completed as to render the article ready for common use, known and designated by a common name, without additional processes of manufacture. While ramie sliver may be bought and sold in the market as 'sliver,' in that form it has no common or popular use other than to be manufactured by the application of additional processes of manufacture into articles which themselves become articles of common use, such as ramie threads, ramie fabrics, ramie hat bands, and other manufactures of ramie, and is not, therefore, a manufacture of ramie. It follows that, inasmuch as there is no specific provision for ramie, or ramie advanced in manufacture, other than those mentioned in the tariff act, its dutiable status must be found within some other provisions of the act by similitude, unless it is to fall back into the classes of nonenumerated unmanufactured or manufactured articles.

"If it is similar in material, quality, texture, or use, as provided in section 7, to any other article enumerated in the tariff act, then it is dutiable by similitude to such, and these similitudes must be exhausted before resort is had to the provisions for nonenumerated unmanufactured or manufactured articles.

"The particulars of comparison in the ascertainment of similitude are enumerated in section 7, which, in so far as pertinent, reads:

"Sec. 7. That each and every imported article not enumerated in this act, which is similar, either in material, quality, texture, or the use to which it may be applied, to any article enumerated in this act as chargeable with duty, shall pay the same rate of duty which is levied on the enumerated article which it most resembles in any of the particulars before mentioned; and if any nonenumerated article equally resembles two or more enumerated articles on which different rates of duty are chargeable, there shall be levied on such nonenumerated article the same rate of duty as is chargeable on the article which it resembles, paying the highest rate of duty."

"The importers contend that the imported articles more nearly resemble line of hemp, provided for in paragraph 327, or, if not that, then dressed line of flax, provided for in paragraph 325. The government contends that the imported article resembles in more of the statutory particulars cotton sliver or roving, provided for in paragraph 302. Much stress was laid at the hearing upon the processes of manufacture through which the various articles went in order to arrive at a condition called 'sliver.' We have already noted that in our opinion, for the purpose of comparison, the variety of processes through which the article has gone is not a safe guide, for the reason that sliver in different materials, and in fact in the same material may be produced by different processes of manufacture.

"From the standpoint of material, ramie, flax, cotton, and hemp are vegetable fibers, probably of the grass order. If there is a difference between them, as there would seem to be by their being enumerated separately in the tariff act, ramie could not be held to be similar to one more than the other in material; or, if similar to any one, it may be equally similar in material to all the others.

"In quality we find many attributes. There may be color or appearance, tensile strength, size, and possibly other immaterial particulars. It appears, from all the authorities at hand and investigation, possible that in no one of the enumerated fibers is the color the same nor the size of the fiber. It is admitted by all that the ramie fiber in tensile strength exceeds all the others. An approximation has been made on the following percentage: Ramie fiber, 100; hemp, 36; flax, 25; silk, 13; cotton, 12. In the course of comparisons, however, it must not be lost sight of that this merchandise is not in the condition of fibers, and the condition of the merchandise as imported is the subject of comparison, and not its condition at some remote period in the course of its manipulation. This article is from three to four feet to a hundred yards or more in length, and is a long rope or ribbon of numerous ramie fibers, which through some process of manipulation have been formed into this condition. None of the fibers have been interwoven or interlaced, but adhere one to the other in longitudinal form. Tensile strength, therefore, as a comparison, should be the tensile strength of the article imported, which is nil, and not the tensile strength of any particular fiber of that article compared with flax or other fibers not in the same condition. The tensile strength of all slivers, independent of the fiber of which it is composed, would be the same, and we think their size and color so variable as not to be the subjects of profitable comparison—particularly where they are dyed different colors, as these are. In texture, if texture is applicable to such material, they would be the same. Some of the secondary definitions of all the lexicographic authorities speak of texture as 'the peculiar disposition of the constituent parts of any body—its make—its consistence.' As compared with cotton sliver, or any other sliver, this sliver from that standpoint would be the same, for the arrangement of the fibers, as above described, is precisely the same.

"In use, as already stated, all slivers are the same; at least, this must be true of chief use, for they are ultimately destined to be spun into thread or woven into fabrics. There is no provision in the tariff law for flax sliver or hemp sliver. There is a provision in the tariff law for but one sliver, and that is for cotton sliver. That this is a comparable status of merchandise must be admitted from the presence of that paragraph in the tariff act, and that ramie sliver is more like cotton sliver than it is like any other different statutory status of any other fiber seems to us beyond question. In the condition imported it is a sliver, and as such must of necessity more nearly resemble the only sliver—cotton sliver—mentioned in the tariff act in all statutory particulars than any other status mentioned by Congress. We are of the opinion that the merchandise was correctly assessed."

This decision of the board was affirmed by the Circuit Court for the Southern District of New York (T. D. 26,462), and, although the ruling of the court was entered by consent, the decision has been acquiesced in during the last three years. The present proceeding is, therefore, an indirect attack upon the judgment then entered by Judge Townsend, and, if successful, would result in the imposition of one rate of duty when the merchandise in question is brought into this district, and of a different rate when it is brought into the Southern District of New York. It is hardly necessary to point out the undesirability of such a result. This has already been done by the Court of Appeals for the Third Circuit in two cases (*Hill v. Francklyn*, T. D. 29,074, 162 Fed. 880, and *Murphy v. United States*, T. D. 29,032, 162 Fed. 871), in each instance affirming the decisions of Judge Holland reported in T. D. 28,856 and T. D. 28,819, respectively. If, therefore, the ruling in *Eckstein's Case* is to be dissented from, I think the proper tribunal to announce such a view is the Court of Appeals, and for this reason I shall follow the formal judgment of the Circuit Court for the Southern District of New York, adding merely that, if the similitude section is applicable, the rate determined thereby is to be prefer-

red to the rate fixed by section 6. *Hahn v. United States*, 100 Fed. 635, 40 C. C. A. 622.

The decision of the Board of General Appraisers is affirmed.

In re GITKIN.

(District Court, E. D. Pennsylvania. September 18, 1908.)

No. 3,013.

1. BANKRUPTCY—"CONTEMPT"—BEFORE REFEREE—ACTS CONSTITUTING.

A bankrupt, who on his examination before the referee deliberately and willfully swears falsely, or falsely denies knowledge of matters about which he is interrogated, refuses "to be examined according to law," and is guilty of "contempt," under Bankr. Act July 1, 1898, c. 541, § 41a (4), 30 Stat. 556 (U. S. Comp. St. 1901, p. 3437).

[Ed. Note.—For other definitions, see Words and Phrases, vol. 2, pp. 1489-1492; vol. 8, p. 7614.]

2. SAME—COMMITMENT FOR CONTEMPT—PROCEDURE.

A court of bankruptcy has no power to commit any person for a contempt committed before a referee, except strictly in accordance with the provisions of Bankr. Act July 1, 1898, c. 541, § 41b, 30 Stat. 556 (U. S. Comp. St. 1901, p. 3437), which requires that the proceedings shall be based on a certificate of the referee.

In Bankruptcy. On rule to show cause why the bankrupt should not be committed for contempt.

J. Howard Reber, for trustee.

B. F. McAtee, for bankrupt.

HOLLAND, District Judge. Joseph P. Gitkin filed a voluntary petition in bankruptcy under date of January 4, 1908, and an adjudication was duly entered thereon on January 18th of the same year. Robert W. Bowlby was elected trustee on February 5th, and subsequently qualified as such. The case was referred to George F. Coffin, referee, at Easton, Pa., and on February 5th and 10th the bankrupt appeared before him, in response to a subpoena, for the purpose of an examination, in accordance with the provisions of section 21a of the bankrupt act (Act July 1, 1898, c. 541, 30 Stat. 552 [U. S. Comp. St. 1901, p. 3430]). The trustee concluded that the witness, in his examination upon both occasions, committed perjury, and through his counsel presented a petition on February 24, 1908, in which he set forth that Joseph P. Gitkin, the alleged bankrupt (1) in the progress of said several examinations testified with willful falsity; (2) said Joseph P. Gitkin, during the progress of the several examinations, repeatedly and continuously testified in a vague, unsatisfactory, ambiguous, and contradictory manner, with the intention of obstructing the administration of justice and preventing the collection and distribution of his property and the discovery of the whereabouts of the same or any considerable portion thereof. Then follows a statement in the petition setting forth, in a summary manner, the matters to which the alleged bankrupt testified showing willful perjury and the intentional,

vague, and ambiguous answers. The witness testified that he had borrowed certain sums of money from three different persons, and that at the time he received the last of the sums from each person he noted the amount in a book, which he produced at the hearing, showing that it was entered therein in June, 1907, and stated he made the entry at that time. An examination of the book shows that it was not published until subsequent to that date, and when the witness' attention was called to this fact he then said that he had copied it into the book produced at the examination from another book and had thrown the other book away. This is a fair sample of the witness' entire testimony, and is urged by the petitioner to be obviously false, showing willful and deliberate perjury. There appears page after page of testimony in which the bankrupt pretended not to know the meaning of what he had written in a book only two months before in connection with his business and his customers, and the only response he made to questions in regard to it was, "I don't know."

Upon this petition a rule was granted upon Gitkin "to show cause why he should not be held in contempt of court for the reasons in the petition set forth." To this he made answer, in which "he denies that the testimony given by him was false, but, on the contrary, avers that his testimony was truthful and responsive to the various questions propounded to him." The answer further objects to the proceeding, for the reason that the rule was granted upon a petition filed by the trustee and not upon a certificate of the referee, as required by section 41b of the bankrupt act, and for this reason asks that the proceeding be dismissed and the bankrupt discharged.

The petition and answer were referred by the court to George F. Coffin, referee, for the purpose of reporting on the allegations set forth in the petition and as to whether the alleged bankrupt had been guilty of contempt, and on May 16th the report was filed, in which the referee finds as follows:

"That Joseph P. Gitkin did commit willful perjury in his examination held before the referee on February 5th and February 10th, and that said perjury consists in his testimony relative to the amount of stock he had on hand in his store on July 1, 1907, to January 1, 1908. * * * The referee finds as a fact that the said Joseph P. Gitkin committed willful perjury in testifying as he did in relation to Exhibit B, testimony relating thereto, * * * under date of February 10th. The testimony as set forth in reference to the memorandum book, 'Exhibit B,' is so evidently false that it merely needs the reading of it to convince the most skeptical person that the bankrupt was willfully and continuously committing perjury in every answer he made."

An examination of the testimony taken by the referee convinces me that Gitkin was testifying falsely through nearly the entire examination. It shows a determination to refuse to give the trustee and creditors any information whatever as to the disposition of his property, or to explain how it came about that he was indebted in certain amounts, which, from all the facts and circumstances, were plainly and certainly claims set up for the purpose of further depleting the already dissipated estate. He pretended to be ignorant of facts which obviously would have been known to any one who had sufficient intellect to perform the most ordinary duties of life, and the evasion and

falsity of the answers are so palpable, so clear, and so persistent as to establish beyond any possibility of a doubt the findings as reported by the referee.

The referee, however, seems to be in doubt as to whether willful perjury and the giving of testimony in a vague, unsatisfactory, ambiguous, and contradictory manner, with the intention of obstructing the administration of justice and preventing the collection and distribution of his property, can be punished as a contempt of court. The things for which a person can be punished for contempt before referees are set forth in section 41a, which provides that:

"A person shall not, in proceedings before a referee, (1) disobey or resist any lawful order, process or writ; (2) misbehave during a hearing or so near the place thereof as to obstruct the same; (3) neglect to produce, after having been ordered to do so, any pertinent document; or (4) refuse to appear after having been subpoenaed, or, upon appearing, refuse to take the oath as a witness, or after having taken the oath, refuse to be examined according to law."

The fourth subdivision of section 41a requires the bankrupt to appear, to take the oath as a witness, and after having taken the oath to submit to an examination according to law. After having taken the oath as required, a refusal to answer questions at all would subject the witness to punishment for contempt for a refusal "to be examined according to law." If a witness be not allowed to obstruct and hinder the administration of a bankrupt's estate and prevent an ascertainment as to the disposition of his property by refusing to answer questions in connection with these matters, and if it be true that a refusal to answer is violative of the command of the fourth subdivision of section 41a of the bankrupt act, requiring a witness to submit to "an examination according to law," can it be said that one who deliberately and willfully makes false answers to all questions propounded, thereby as effectually closing the avenues of inquiry as to the bankrupt's estate as if he had refused to answer, has not refused "to be examined according to law" because he makes answer, when his answers are intentionally and plainly false and effect the same result as a refusal to answer at all? It is very plain that where a bankrupt persistently, through page after page of his testimony, answers "I don't know" to questions about his property which he must and evidently does know, and could make full answers, he refuses "to be examined according to law" with the same effect as though he refused to make answer at all. An "examination according to law" requires that questions shall be answered, and answered truthfully, and a witness does not satisfy the law by simply making answer which gives absolutely no information whatever in regard to the questions being inquired about, when it is very plain that the witness is entirely competent to give the desired information, but is deliberately and willfully prevaricating in order that the truth may not be discovered. So that it is our judgment that a witness who refuses to answer, or makes willfully false answers, and thereby obstructs the prompt and proper administration of the bankrupt law, is guilty of contempt, and can be punished under section 41b of the act. *In re Salkey*, 6 Biss. 280, Fed. Cas. No. 12,254;

In re Fellerman (D. C.) 149 Fed. 244, 17 Am. Bankr. Rep. 785; Ex parte Bick (C. C.) 155 Fed. 908; Loveland (2d Ed.) 622.

This bankrupt being guilty of contempt, the facts should have been certified as requested by counsel for the trustee. Instead of such a certificate, as required by section 41b of the bankrupt act, this proceeding was started by a petition of the trustee upon which a rule to show cause was granted, and the respondent, by his counsel, objects to the proceeding, for the reason that it does not comply with the requirements of the act of Congress and there is therefore no warrant in law for the commitment of Gitkin for contempt under proceedings of this kind. Section 725 of the Revised Statutes (U. S. Comp. St. 1901, p. 583) points out very distinctly the cases in which District and Circuit Courts are authorized to punish for contempt. They are limited to three classes of cases: (1) Where there has been misbehavior in the presence of the court, or so near thereto as to obstruct the administration of justice; (2) where there has been misbehavior of any officer in his official transactions; (3) and where there has been disobedience to any order, process or command of the court. Ex parte Robinson, 86 U. S. 512, 22 L. Ed. 208.

The power of the courts to punish for contempt has always been looked on in this country with much jealousy, and a very strong disposition shown in all jurisdictions to restrain it. It has been declared to be arbitrary in its nature (*Batchelder v. Moore*, 42 Cal. 412), and to be an exception to the provisions of the Constitution of the United States and not to be extended in the least degree beyond the limits imposed by statute (*Boyd v. Glücklich*, 8 Am. Bankr. Rep. 401, 116 Fed. 136, 53 C. C. A. 451). The sole power of a federal court to punish for contempt of its authority, both at law and in equity, is derived from this section. Ex parte Robinson, supra; *Kirk v. Milwaukee Dust Collector Co.* (C. C.) 26 Fed. 505. The proceeding is in its nature criminal, and must be governed by the strict rules of construction applied in criminal cases. "Its purpose is not to afford a remedy to the party complaining, and who may have been injured by the act complained of. That remedy must be sought in another way. Its purpose is to vindicate the authority and dignity of the court." *Kirk v. Milwaukee Dust Collector Co.*, supra, and cases there cited.

Whether or not the District Court would have punished the misbehavior of the alleged bankrupt before the referee under proceedings of the kind had in this case if there had been no statutory procedure pointed out by the bankrupt act need not now be inquired into, although it has been held that the District and Circuit Courts have jurisdiction under section 725 of the Revised Statutes to punish for misbehavior in presence of subordinate officers, such as commissioners, masters in chancery, and referees appointed by these courts (*United States v. Anonymous* [C. C.] 21 Fed. 761); but, as we have said, it is not necessary to extend this inquiry, because Congress has enacted a mode of procedure for contempt proceedings before a referee in bankruptcy. Section 41b requires that:

"The referee shall certify the facts to the judge, if any person shall do any of the things forbidden in this section. The judge shall thereupon, in a summary manner, hear the evidence as to the acts complained of, and, if it is

such as to warrant him in so doing, punish such person in the same manner and to the same extent as for a contempt committed before the court of bankruptcy."

This section makes it plain that the power to commit for contempt before a referee was not conferred upon the latter, but was conferred on the judge of the court of bankruptcy before whom the matter must be certified in accordance with its provisions; and, in order that the court may take cognizance of the offense and punish the offender, he must be proceeded against strictly in accordance with the mode pointed out by the bankrupt act, and any deviation from that procedure the bankrupt may take advantage of on a motion to dismiss the proceedings. The statutory procedure, being full and complete, must be strictly followed, and a failure to do so will be fatal.

For the reasons given, the rule to show cause why the alleged bankrupt should not be committed for contempt is discharged.

UNITED STATES v. CLARK et al.

(District Court, W. D. Missouri, W. D. May 29, 1908. Additional Opinion,
July 7, 1908.)

No. 2,662.

1. CONSPIRACY — CONSPIRACY TO COMMIT OFFENSE AGAINST UNITED STATES — VIOLATION OF INTERSTATE COMMERCE LAW.

Hepburn Act June 29, 1906, c. 3591, § 1, 34 Stat. 584 (U. S. Comp. St. Supp. 1907, p. 892), which makes it a criminal offense for a common carrier to issue any interstate free transportation, except to certain classes of persons, and for any person not belonging to one of such classes to use such free transportation, does not subject to punishment the officer or agent who issues such transportation, nor a person to whom it is issued, unless he uses the same; and hence an indictment will lie, under Rev. St. § 5440 (U. S. Comp. St. 1901, p. 3676), for conspiracy to commit an offense under said act, against an agent of a railroad company and others, to whom by agreement he issues interstate free passes on behalf of said company, and who pursuant to such agreement sell the same for use by others not within the excepted classes.

2. SAME—DEFENSES.

An agent of a railroad company, having authority to issue passes, indicted with others for a conspiracy to issue interstate free passes, to be, and which were, used in violation of Hepburn Act June 29, 1906, c. 3591, § 1, 34 Stat. 584 (U. S. Comp. St. Supp. 1907, p. 892), cannot defend on the ground that his principal had no knowledge of the fact, and therefore committed no offense under the act.

On Separate Demurrer of Defendant Samuel C. Clark to Indictment.

A. S. Van Valkenburgh, U. S. Atty.

S. W. Moore and Leon Block, for defendant Samuel C. Clark.

POLLOCK, District Judge. This is a criminal prosecution by indictment, brought under the provisions of section 5440, Rev. St. (U. S. Comp. St. 1901, p. 3676), against one Samuel C. Clark, chief clerk in the office of the general superintendent of the Missouri Pacific Rail-

way Company, and as such clerk vested with the power of issuing free interstate transportation over the lines of said railway company, and against Nick Nistas and Louis Agnes, Greek laborers engaged in the business of procuring laborers to work upon railroads. The indictment in substance charges Clark, Nistas, and Agnes with conspiring and confederating together to commit an offense against the laws of the United States, in this, to wit: In pursuance of an unlawful agreement to so do, the defendant Clark, as chief clerk of the general superintendent of the railway company, agreed to, and did, issue free interstate transportation or passes to Nistas and Agnes for themselves and many other laborers, which free transportation or passes were by Nistas and Agnes agreed to be, and were, for their benefit, sold to other persons, who were carried on such interstate transportation. That such persons so carried on such free interstate transportation or passes were not such persons as are excepted from the operation of, but are within the class of persons prohibited from using free interstate railway transportation under the provisions of section 1 of what is commonly known as the "Hepburn Act" (Act June 29, 1906, c. 3591, 34 Stat. 584 [U. S. Comp. St. Supp. 1907, p. 892]), which, in so far as material here, reads as follows:

"No common carrier subject to the provisions in this act, shall, after January first, nineteen hundred and seven, directly or indirectly, issue or give any interstate free ticket, free pass, or free transportation for passengers (except as stated). Any common carrier violating this provision shall be deemed guilty of a misdemeanor and for each offense, on conviction, shall pay to the United States a penalty not less than one hundred dollars nor more than two thousand dollars, and any person, other than the persons excepted in this provision, who uses any such interstate free ticket, free pass, or free transportation shall be subject to a like penalty."

To this indictment defendant Clark has filed his separate demurrer, which has been fully presented in oral argument and on briefs of counsel. The theory of counsel for Clark is this: That a corporation can act only through its authorized agents. Therefore the defendant Clark stands in this case for the railway company in the issuance of the prohibited free interstate transportation to defendants Nistas and Agnes. That the offense prescribed and punished by section 1 of the Hepburn act, above quoted, is complete in itself and requires a multiplicity of agents to unite in the accomplishment of the offense therein prescribed; that is to say, some authorized representative of the railway company to issue the prohibited free transportation on the part of the railway company, and some unauthorized person or persons, as were Nistas, Agnes, and others, to use such transportation in being carried on an interstate journey. Therefore, as the indictment in this case charges the completed offense of the issuing of such unlawful free transportation by the railway company, on the one hand, and its receipt and use by Nistas and Agnes, on the other, the punishment prescribed by the Hepburn act must follow. That such completed offense, requiring a multiplicity of agents for its accomplishment, cannot be made the basis of an indictment for conspiracy under the provisions of section 5440, as is attempted in this case, for that in such case to uphold the indictment would place within the power of

the District Attorney to enlarge the punishment prescribed by Congress for a violation of the Hepburn act into that more severe punishment prescribed by Congress for a violation of the conspiracy act (section 5440). And *U. S. v. Dietrich* (C. C.) 126 Fed. 664, and *U. S. v. New York Central Railway Company* (C. C.) 146 Fed. 298, applying the rule stated by Mr. Wharton in his *Criminal Law* (section 1339), are cited in support of the contention made. The rule as stated by Mr. Wharton is:

"When the law says a combination between two persons to effect a particular end shall be called, if the end be effected, by a certain name, it is not lawful for the prosecution to call it by some other name; and when the law says such an offense—e. g., adultery—shall have a certain punishment, it is not lawful for the prosecution to evade this limitation by indicting the offense as conspiracy."

With the rule as applied in the *Dietrich* and *New York Central Cases*, *supra*, and many other cases, there certainly can be no just or rational cause of complaint. And if this case be one of the simple issuance of prohibited railway transportation by a railway company through its agent empowered to issue such transportation, on the one hand, and its use by the recipient, not falling within the excepted classes as enumerated in the act, on the other, I am persuaded such offense cannot and should not be made the basis of a charge of conspiracy under section 5440, but should be charged, tried, and punished as the Congress has provided in the Hepburn act, and in no other manner or way; for to my mind it would be most intolerable, indeed, if the criminal laws of our country be such that the extent of the punishment for wrongdoing may be made to depend on the form of its presentation to the court, and not on the will of Congress, as provided in the law creating and defining the offense and prescribing the punishment. It therefore becomes material here to inquire whether the rule stated by Mr. Wharton in his work, and as applied in the cases above cited, is applicable to the facts charged in this indictment, or whether the acts here charged against the defendants do not fall within the exception to the rule.

There can be no doubt but that the act of Clark in issuing the transportation in question was the act of the railway company, for which it may be charged, tried, and punished under the terms and provisions of the Hepburn act, as could be the prohibited persons who use such transportation. But the Congress has not deemed it proper by the terms of the Hepburn act to punish the officer, agent, or servant of a railway company who issues prohibited free interstate transportation, but the company he represents alone. Nor has Congress by the terms of that act made criminal the acceptance, possession, or sale of prohibited free transportation, but has made criminal alone the act of the person who uses such prohibited transportation for the purpose of being carried on an interstate journey. It is therefore quite clear to my mind the acts charged against defendants, although completed in purpose, do not constitute on behalf of the defendants here represented a violation of the provisions of the Hepburn act.

It therefore follows, if the defendants, as charged, agreed and confederated together to cause the railway company to violate the

provisions of the Hepburn act by the issuance of this free transportation, or the nonexcepted persons in whose hands such transportation might come to use such transportation for the purpose of being carried by the railway company in interstate travel, then, in my opinion, they may be presented; tried, and punished as for a conspiracy to violate the provisions of the Hepburn act; for they are clearly within the exception to the rule as stated by Mr. Wharton, as follows:

"Of course, when the offense is not consummated, and the conspiracy is one which by evil means a combination of persons is employed to effectuate, this combination is of itself indictable; and hence persons combining to induce others to commit bigamy, adultery, incest, or dueling do not fall within this exception, and may be indicted for conspiracy." Wharton's Crim. Law, § 1339.

This exception to the rule was applied by Circuit Judge Adams, delivering the opinion of the Circuit Court of Appeals for this Circuit in the case of *Thomas & Taggart v. United States*, 156 Fed. 897, 84 C. C. A. 477, as follows:

"If, when the coaction of two or more persons is necessary to complete the commission of a crime, no outside persons, however effectually and wickedly they may have conspired with them or either of them to bring about the violation of the law, can be held for a conspiracy, immunity from a most salutary criminal provision is found for many of the worst violators of the law. It is the schemers who set afoot the infractions of the law that are most dangerous to the public weal, and we cannot believe that Congress ever intended, *except in cases of a clear doubling of punishment of the same persons for the same offense, to relieve them from amenability to the conspiracy statute.*" (Italics mine.)

As said by Mr. Justice Brewer, delivering the opinion of the court in *Clune v. U. S.*, 159 U. S. 590, 16 Sup. Ct. 125, 40 L. Ed. 269:

"The language of the section is plain, and not open to doubt. A conspiracy to commit an offense is denounced as itself a separate offense, and the punishment therefor fixed by the statute, and we know of no lack of power in Congress to thus deal with a conspiracy. Whatever may be thought of the wisdom or propriety of a statute making a conspiracy to do an act punishable more severely than the doing of the act itself, it is a matter to be considered solely by the legislative body. *Callan v. Wilson*, 127 U. S. 540-555, 8 Sup. Ct. 1301, 32 L. Ed. 223. The power exists to separate the conspiracy from the act itself, and to affix distinct and independent penalties to each."

It follows, from what has been said, the separate demurrer of the defendant Clark must be overruled; and it is so ordered.

Additional Opinion.

It is now further contended by defendant Clark, in support of his separate demurrer to the indictment, that the act of the issuance of free interstate passes must have been knowingly done on the part of the defendant railroad company, or some officer or agent having authority to issue the same, in case where the knowledge of such officer or agent would be attributed to the company; and *Conrad v. United States*, 127 Fed. 800, 62 C. C. A. 478, *Salla v. United States*, 104 Fed. 544, 44 C. C. A. 26, and *Armour Packing Co. v. United States*, 209 U. S. 56, 28 Sup. Ct. 437, 52 L. Ed. 681, are cited in sup-

port of the contention made. This proposition, I think, must be conceded.

Based on this proposition the further argument is made, as it is charged in the indictment that defendant Clark is the only representative of the railroad company alleged to have had such guilty knowledge, and as it is further charged that Clark was in a conspiracy against his company, hence guilty knowledge possessed by him will not be imputed to the railroad company. Therefore the indictment, in failing to charge such fact as will, if proven, show a violation of the Hepburn act on the part of the railroad company, although the prohibited transportation was in fact issued, fails to charge any offense against defendants as conspirators. And *American Surety Company v. Pauly*, 170 U. S. 133, 18 Sup. Ct. 552, 42 L. Ed. 977, *School District v. De Weese* (C. C.) 100 Fed. 705, *Central Coal & Coke Co. v. Good*, 120 Fed. 793, 57 C. C. A. 161, and other cases, are cited in support of this contention. However, this is a prosecution against Clark and others; not against the railroad company.

Conceding the railroad company might, when prosecuted for issuing prohibited free transportation in violation of the provisions of the Hepburn act, defend itself on the ground it had no guilty knowledge of the prohibited act done by its guilty agent in conspiracy with others against it, yet the question remains, can Clark, in defense of this prosecution against him, assert such rule in his defense? I think not. As charged, he knew, and it will not lie in his mouth to say his knowledge is not the knowledge of his principal, the railroad company, on any ground except by confession, of his guilty participation in the conspiracy charged. If the railroad company is not guilty of a violation of the law, it is because Clark is guilty of a conspiracy to cause a violation of the law on the part of the railroad company.

I am still of the opinion the demurrer to the indictment must be overruled. It is so ordered.

HEIN v. WESTINGHOUSE AIR BRAKE CO.

(Circuit Court, N. D. Illinois, E. D. September 25, 1908.)

No. 28,067.

COURTS—FEDERAL COURTS—CONFORMITY TO STATE PRACTICE.

If to conform strictly to the state practice would unwisely incur the administration of the law and tend to defeat the ends of justice in a given case, a federal court has power to reject the local rule of pleading as to subordinate matters of form, under Rev. St. § 914 (U. S. Comp. St. 1901, p. 684), which requires conformity to the state practice only "as near as may be."

[Ed. Note.—For cases in point, see Cent. Dig. vol. 13, Courts, § 921.

Conformity of practice in common-law actions to that of state court, see notes to *O'Connell v. Reed*, 5 C. C. A. 594; *Nederland Life Ins. Co. v. Hall*, 27 C. C. A. 392.]

At Law. On motion by plaintiff for an order to simplify the pleadings.

D. S. Wegg, for plaintiff.
Dolph, Buell & Abbey, for defendant.

SANBORN, District Judge. Action of covenant to recover an agreed sum on the sale of a patent right. Plaintiff moves for an order to simplify the pleadings, and to relieve him from a strict compliance with the rules of common-law pleading, in order to prevent undue and vexatious prolixity. The questions presented are whether the court has power to change the rule of pleading, and whether, if it has the power, it should be exercised in this case.

To the declaration defendant pleaded non est factum, and 21 pleas, to the effect that plaintiff was not the owner of the inventions covered by the contract sued on; that for the same reason the consideration failed; that plaintiff was not the owner or inventor of the generic invention sought to be assigned, but only of certain subordinate features thereof, which are of no value to defendant without the broad invention; that for the same reason the consideration failed; that plaintiff covenanted in the contract sued on that he was the owner of the inventions assigned, but he was not such owner; that the consideration has failed for the same reason; that for the same reason there is a breach of covenant, because the use of the subordinate features assigned is of no value without the broad invention; that for like reasons the consideration has failed; that plaintiff covenanted in such agreement to prosecute to effect applications for patents on the inventions assigned, and secure such patents, but did not do so, his applications being rejected as to the broad invention, and that the subordinate inventions are of no value without the other; that for the same reason the consideration has failed; that by reason of the rejection of plaintiff's application defendants have been evicted from the use of the inventions sought to be assigned; for the same reason the consideration has failed; eviction in another form, in connection with other terms of the contract, is pleaded; failure of consideration for the same reason; that plaintiff did not prosecute his application for patent with reasonable diligence; failure of consideration for the same reason; that the Patent Office decided an interference proceeding between plaintiff and one Shepard, involving the inventions sought to be assigned, in Shepard's favor, from which decision plaintiff took no appeal, and for that reason plaintiff's invention was worthless; failure of consideration for the same reason; and that the plaintiff's device was inoperative, wherefore the consideration has failed.

The 22 defenses are practically resolved to 4: That defendants did not make the contract sued on, that plaintiff was not the owner or inventor of the patent right attempted to be sold or assigned, that such right was worthless, and that the Patent Office decided that another man was the real inventor of the device sought to be assigned; but by the common-law system of pleading in force in this district it takes 70 pages of typewriting to state these 4 defenses, 60 pages of which are mere repetition.

The attorney for the plaintiff, conceiving that he has numerous defenses to the defendant's pleas, finds their presentation under the common-law system somewhat cumbersome. He does not want the

court to do what the Legislature did in creating the Cook county municipal courts, abolish all pleading whatever by substituting a bill of particulars; but, conceiving that the application of the highly technical rules of Chitty and Stephen will, in the language of the Supreme Court, "unwisely incur the administration of the law" and "tend to defeat the ends of justice" (*Railroad Co. v. Horst*, 93 U. S. 291, 300, 23 L. Ed. 898), he applies to the court for an order allowing him to reply his defenses without the necessity of repeating, in the statement of each defense, the recital of facts supporting all or most of such defenses. To use his own language, this is "to avoid unnecessary repetition, unconscionable prolixity and confusion, and resulting enormous record, and to make plain and simplify the issues." And he insists that a federal court, by the terms of Rev. St. § 914 (U. S. Comp. St. 1901, p. 684), providing that the practice, pleading, forms, and modes of proceeding in the federal courts shall conform as near as may be to the practice, etc., in the courts of the state, is authorized to relieve him from the necessity of repeating the statement of the same facts in each separate replication, and to permit him, if the defendant will suffer no injury, to state his facts once for all, and reply all his defenses without repetition. He further states that any order to be made on this application should relate to form only, and not substance, and should not be construed as deciding the substantial validity of any defense or reply so authorized.

It may be said that the facts claimed by plaintiff to exist, or the more important ones, quite briefly stated, are that in 1902 Hein conceived that he had discovered a certain broad, generic invention in friction draft and buffing apparatus for use on railroad cars, and filed applications for a patent, and for patents on apparatus subsidiary to the broad invention. Shepard also claimed prior discovery of the same broad invention. After negotiation with Westinghouse the contract in suit was made, dated November 24, 1902, assigning the inventions, and all like inventions acquired by Hein, to Westinghouse, who was to pay 25 cents on each device of all friction draft and buffing apparatus made by Westinghouse, or by his licensee, the Westinghouse Air Brake Company, in consideration of the sale. Hein was to diligently prosecute his applications in the Patent Office. Payments were to be made quarterly, and considerable sums were paid until July 1, 1905, when further payment was refused on the ground that the contract conveyed nothing, and was made by mistake of fact. This suit was thereupon commenced, being an action at law on the contract. In January, 1906, Westinghouse and his company commenced a suit in equity in this court to restrain the action at law on the contract, on the same ground that they stopped payment. A demurrer to the bill was sustained by the Circuit Court, and on appeal by the Circuit Court of Appeals, on the ground that the suit was prematurely brought, in that it did not appear that Hein, whose claims for his generic invention had been rejected by the Patent Office, might not ultimately obtain a patent. 159 Fed. 936.

In his statement of facts plaintiff states the history of the negotiations leading to the contract, and all the proceedings in the Patent

Office. From such statement it appears that one Shepard had filed an application for a patent on friction draft apparatus, and the Commissioner declared an interference between Hein and Shepard. After various proceedings it was finally decided that Shepard's claims were prior to Hein's, and Shepard got a patent; Hein's claims being rejected. After final rejection Hein appealed, and was finally awarded a patent on his claims. He also obtained patents on his subordinate claims, and procured and tendered to Westinghouse, under the contract, an assignment of the Shepard patent. The statement of these alleged facts in detail occupies 37 typewritten pages. Plaintiff bases upon these alleged facts a number of defenses by way of reply to the pleas set up by defendant. These defenses are alleged estopped in pais, alleged ratification by making payments on the contract with knowledge of all the facts alleged *res judicata*, and a general defense consisting of the replication *de injuria*, to the effect that plaintiff is not to blame for defendant's alleged breach of its contract, but that it is all its own fault. The defenses are simple and easy of statement in themselves; but as the common-law system of pleading requires a replication to each plea, and that each replication must be complete in itself, it is necessary to state, in connection with each replication of estoppel in pais, all the facts relied on to establish the estoppel, so that the 37 pages, more or less, of statement would have to be repeated 21 times. The other defenses do not require so much recital of facts, but it is evident to me that plaintiff's attorney could not state these defenses in much less than 2,000 pages. My estimate of the number of replications necessary is 155. Counsel thinks that it would take 180. He has presented all these defenses in 73 pages, without repetition, and now asks to be relieved from the necessity of such repetition, required by the modified common-law procedure in force in Illinois.

The common-law system of pleading is a method of ascertaining the matters to be adjudged, and sharply separating matters of law and fact. Its whole object is logical certainty and absolute clearness. It is said to be a science of law and logic, designed to so formulate the contentions as to best develop the questions of law and fact which are involved in the controversy. If the replications, and the possible rebutters and surrebutters to follow, are to be stated according to this system, the court might possibly, with the aid of an expert and a set of double entry books, find out what the real contentions are "with logical certainty and absolute clearness." Instead of producing certainty, the application of the common-law system to a case of this complication tends to mystification, prolixity, and unnecessary repetition. The question, however, is whether the court has power to relieve the plaintiff from the plain rule of the Illinois law. If to conform to the state practice would unwisely incumber the administration of the law and tend to defeat the ends of justice, the court has power to reject the local rule. *Southern Pacific Co. v. Denton*, 146 U. S. 202, 13 Sup. Ct. 44, 36 L. Ed. 942. As said by the Supreme Court in *Mexican Railway v. Pinkney*, 149 U. S. 194, 207, 13 Sup. Ct. 859, 37 L. Ed. 699:

"The words of this section, 'as near as may be,' were intended to qualify what would otherwise have been a mandatory provision, and have the effect to leave the federal courts some degree of discretion in conforming entirely

to the state procedure. These words imply that in certain cases it would not be practicable, without injustice or inconvenience, to conform literally to the entire practice prescribed for its own courts by a state in which federal courts might be sitting."

See, also, *Shepard v. Adams*, 168 U. S. 618, 18 Sup. Ct. 216, 42 L. Ed. 604.

Section 914, then, is not mandatory in the sense of adopting every subordinate rule of the state practice. That practice as a whole is adopted; but the court may reject some subordinate rule, and exercise some degree of discretion in declining to conform absolutely and entirely to the state practice. The rule of the common-law practice that each plea or replication must be complete in itself, and state all facts necessary to support the defense set up, is one of form only, occupying an entirely subordinate position in the system, and in no way affecting such system in any substantial way. To reject it is not to refuse to be governed by the Illinois system, not to change it in substance, but merely to permit a formal departure from it in this case only, for the reason that it would unwisely incumber the administration of the law to compel strict adherence to it. I think, therefore, the plaintiff should be permitted to state the facts once for all, and file such pleas as he may be advised, which may be treated as if such statement of facts was repeated in each such plea.

Plaintiff also moves to be allowed to reply generally to all defendant's special pleas by one traverse *de injuria*. This may also be done; but the validity of such traverse, as applied to any or all the special pleas, is not in any way now passed upon or considered.

Another matter of some importance remains for discussion. From plaintiff's proposed statement of facts it appears that a number of facts which are deemed quite important by him, and which, if shown in proof, might have a vital effect on the suit, occurred after the action was brought. The chancery suit and its decision that there was no final judgment against Hein in the patent suit were long after this suit. Several months after it was begun Hein bought the Shepard patent, and on January 15, 1908, paid up in full for it, took a conveyance thereof, and gave notice of it to defendant, which became the owner of such patent under the contract in suit. In October, 1907, plaintiff appealed from the decision rejecting his claims, and on January 23, 1908, the decision was reversed, and a patent awarded to Hein, and issued to him February 18, 1908, and notice thereof given to defendant. It will be seen that these facts so occurring after suit brought may, if pleaded and proven to be true, have a great influence on the result. But as the parties are now pleading for the first time, the suit having been treated as stayed pending the hearing in the chancery suit at the circuit and on appeal, the pleading of these facts is not by way of amendment, or by way of pleading *puis darrein* continuance, but rather their recital in the first pleadings filed. The plaintiff may, with-out leave of court, plead anything he may be advised, leaving its propriety to be determined, if properly challenged by defendant.

An order may be entered permitting plaintiff to reply to two or more special pleas by one replication, to file two or more replications to the same plea, to reply several matters to one or more pleas, to reply

generally by traverse de injuria, to include therein two or more pleas, and to make a single statement of facts, without the necessity of repeating the same or any part thereof in any replication, such statement being taken as if the whole thereof were repeated in each replication, except the replication de injuria. But the defendant is not to be prejudiced by such change of form, nor its rights affected. It may demur, plead, or otherwise object in any manner, except to raise formal objections justified by the order, to the same extent as if this direction were not made.

DITTMEN v. RACINE PAPER GOODS CO.

(Circuit Court, E. D. Wisconsin. May 1, 1905.)

INJUNCTION—SUBJECTS OF PROTECTION—INJURY TO BUSINESS.

Equity has jurisdiction of a suit to enjoin injury to a manufacturing business by circulating statements that the product is an infringement of patents, and threatening suits for infringement against the manufacturer and his customers, in bad faith, for the sole purpose of injuring his trade, and without intention to sue.

In Equity. On demurrer to bill.

George B. Parkinson, for complainant.

Winkler, Flanders, Bottum & Fawsett, for defendant.

SEAMAN, Circuit Judge. The allegations of the bill state a cause of action clearly within the decisions of the Circuit Courts of Appeals in the Third and Second circuits (*Farquhar Co., Limited, v. National Harrow Co.*, 102 Fed. 714, 42 C. C. A. 600, 49 L. R. A. 755, and *Adriance, Platt & Co. v. National Harrow Co.*, 121 Fed. 827, 58 C. C. A. 163), wherein like allegations were held to state a good cause of action in equity; and in an early case in this circuit (*Emack v. Kane* [C. C.] 34 Fed. 46) Judge Blodgett sustained a similar bill upon like grounds. On behalf of the demurrant numerous cases in the state courts are cited by counsel upholding the proposition that such courts decline to restrain torts in the nature of libels on business, slanders of title, and the like, several of which are plainly applicable to this bill. They also cite decisions of Circuit Courts of the United States of like effect, including an opinion by Mr. Justice Bradley in *Kidd v. Horry* (C. C.) 28 Fed. 773, which is strongly in point. I deem it unnecessary to review these authorities, for the reason that the Circuit Court of Appeals opinions above referred to, if not decisive, impress me as upholding the true rule under the trend of modern authorities, and I am of opinion that they should be followed.

The case of *Francis v. Flinn*, 118 U. S. 385, 388, 6 Sup. Ct. 1148, 30 L. Ed. 165, while upholding the general doctrine for which the defendant contends, is not opposed to the rulings in the above-mentioned cases, and seems to me fairly distinguishable. Jurisdiction in equity is not tested alone by the fact of a remedy existing at law, but, as stated in the early case of *City of Georgetown v. Alexandria Canal Co.*, 12 Pet. 91, 98, 9 L. Ed. 1012, the jurisdiction may be sustained

“upon the principle that equity can give more adequate and complete relief than can be obtained at law,” cited in *Re Debs*, 158 U. S. 587, 15 Sup. Ct. 907, 39 L. Ed. 1092. The line of decisions cited on behalf of the complainant, upholding such jurisdiction in cases of unfair trade and unfair competition, are pertinent and instructive in this view.

I am of opinion that both reason and authority are with the complainant, and that the demurrer must be overruled. It is so ordered, with leave to answer by the next rule day.

DITTGEN v. RACINE PAPER GOODS CO.

(Circuit Court, E. D. Wisconsin. April 27, 1908.)

1. INJUNCTION — GROUNDS — SLANDER OF TITLE—PATENTS — INFRINGEMENT — THREATENING SUIT.

Complainant and defendant were competing manufacturers of individual cigar pouches made of paper in sheets, and were the only manufacturers of the same in the United States. Each manufactured under patents. During five years defendant by letters and through its salesmen represented to purchasers that complainant was infringing its patents and threatened suits against users of his product, causing customers of complainant to refuse to give him orders and to cancel orders previously given; the result being a serious injury to his trade. It was also shown that complainant submitted a sample of his goods to defendant and requested the bringing of a suit to determine the rights of the parties; but no such suit was brought, although defendant continued to make the same representations of infringement and threats of suit. *Held*, that such representations and statements were false and malicious, and that complainant was entitled to relief in equity by an injunction and accounting for damages.

[Ed. Note.—For cases in point, see Cent. Dig. vol. 27, Injunction, § 171.]

2. LIMITATION OF ACTIONS—COMMENCEMENT OF SUIT—AMENDMENT OF BILL.

Complainant brought suit against a corporation to recover damages for unfair competition in trade, alleged to have been practiced during a number of years by defendant. Both bill and answer proceeded on the theory that all the acts charged, if committed, were those of defendant; but it incidentally appeared in the proofs that during a part of the time the business had been conducted by a partnership under the same name as defendant corporation, which was organized by the partners and succeeded to the property and business and assumed the liabilities of the partnership, whereupon by consent of parties complainant amended his bill to conform to the proofs and to hold defendant liable upon its assumption. *Held*, that such amendment did not introduce a new cause of action and related back to the filing of the bill, for the purpose of arresting the running of the statute of limitations.

[Ed. Note.—For cases in point, see Cent. Dig. vol. 33, Limitation of Actions, § 545.]

In Equity. On final hearing.

This is a final hearing in equity. The bill charges that the defendants have been guilty of unfair trade and competition; that complainant is, and for more than 20 years last past has been, engaged in the manufacture and sale of paper cigar pouches; that for 15 years he has manufactured and sold individual cigar pouches connected in sheets; that for 5 years last past his cigar pouches have been made in accordance with letters patent No. 662,226, issued to him November 20, 1900, and that complainant is financially respon-

sible; that the defendant, a Wisconsin corporation, has for several years been engaged in the manufacture and sale of paper cigar pouches and is asserting certain rights under various letters patent of the United States pertaining to individual cigar pouches, granted prior to the date of complainant's patent, and of but limited scope; that complainant has encroached upon none of the defendant's patents; that the parties to this suit are the only parties in the United States engaged in the manufacture and sale of such pouches; that the defendant has been fully informed of the manufacture and sale of complainant's cigar pouches, and with full details of the construction thereof for more than 5 years, and that defendant is abundantly able financially to prosecute suits for any supposed infringement of his letters patent; that defendant, for the purpose of stifling competition, and with intent to break up and destroy complainant's business, has been systematically circulating among complainant's customers and the trade generally letters representing that the complainant's pouches infringe upon letters patent owned or controlled by the defendant, and that complainant's customers will render themselves liable in damages if they use complainant's pouches; that for five years the defendant, by its numerous agents, has been making oral representations to the trade to the same effect, and has further represented that an injunction has been secured restraining the complainant from the manufacture of paper cigar pouches; that threats have been employed that suits would be commenced against any of the trade who continued to use the complainant's pouches; that thereby the defendant has made it generally understood in the trade that the defendant owned or controlled patents which would subject customers to damages if they purchased and used the complainant's pouches; that all of said representations by the defendant are false and malicious, and made in bad faith, for the purpose of destroying the complainant's business; that complainant submitted to the defendant a sample of his cigar pouch, and requested it to commence suit against him, in order that the rights of the several parties might be judicially determined, and offered to accept service of summons in any court of competent jurisdiction, and join with defendant in bringing the respective rights of the parties to an early adjudication, all of which the defendant has failed and refused to do, but still persists in continuing said false and malicious representations, and will so continue unless restrained by the court; that the complainant's trade has been seriously injured by such unfair methods; that large orders for complainant's goods have been canceled, and other customers have been deterred from giving orders which they would otherwise have given for the complainant's goods, because of the fear inspired by the false and malicious representations of the defendant; that by reason of the premises the complainant's business has been injured to the extent of \$40,000, and will be entirely ruined, and the complainant's loss irreparable, unless the defendant is restrained from continuing such unfair methods. Prayer for an injunction and an accounting.

The answer admits that defendant and complainant are the only parties in the United States engaged in the manufacture and sale of cigar pouches; that it has been informed of the manufacture and sale of cigar pouches by complainant, and many of the details of the construction thereof, for more than five years; and that defendant is abundantly able financially to prosecute a suit for supposed infringement. The defendant denies that its representations heretofore made were false, malicious, or made in bad faith, and for the purpose of unfairly destroying complainant's business. Then follows a series of denials, which amount to a negative pregnant, denying various averments in the very language of the bill, which hardly enlarge the scope of the general denial, with which the answer closes.

After the proofs had been taken, complainant obtained leave to amend the bill in accordance with the proofs, as follows: "First. By inserting after the introductory clause thereof: 'That the defendant corporation succeeded, on or about January 1, 1902, to the business of a copartnership, consisting of Orville L. Parmenter, Lucius J. Elliott, and Richard T. Robinson, doing business at said Racine under the firm name and style of Racine Paper Goods Company, and took the assets and assumed the liabilities of said firm; that the members of said copartnership became the charter members of said corporation; and that the change was merely a merger of the copartnership into

the corporation.' Second. By inserting after the third paragraph of the body of the bill: 'And your orator further says: That the same kind of wrongful acts herein charged against the defendant were, prior to its incorporation as aforesaid, committed by its predecessor in business, the said Racine Paper Goods Company.' Third. By inserting in the second clause of the prayer of said bill, after the word 'defendant,' the words 'and its predecessor in business.'"

In like manner the defendant obtained leave to amend the answer in accordance with the proofs, by inserting the following allegation: "That none of the acts or doings complained of by the complainant in his bill herein, as against the individuals or partnership preceding the formation of the defendant corporation, were done within six years prior to the date of this amendment, to wit, the 4th day of February, 1908, and that any and all such acts and doings on the part of such partnership are thereby barred by the statute of limitations applicable thereto, the same to be incorporated in apt language in the answer of the defendant."

By consent of parties the following order was made relating to certain depositions taken by the defendant: "It is further ordered, by consent of parties, in relation to the admission of the depositions of Frank M. Haskell, Siegfried Raatz, and Benson S. Paige, a motion having been made to suppress the same by the complainant, that the same may be admitted and read in evidence in this cause; it being conceded that the complainant failed to receive actual notice of the examination of these witnesses, and if he had received such notice prior to their examination he would have attended and cross-examined, and that the testimony of Gratz as to letters moving him not to say anything against Dittgen & Co. is to be considered as relating only to the letters in evidence addressed to him."

George B. Parkinson, for complainant.

Winkler, Flanders, Smith, Bottum & Fawsett, for defendant.

QUARLES, District Judge (after stating the facts as above). A demurrer was interposed to the bill. The decision of Judge Seaman (164 Fed. 84) overruling the demurrer has settled the law of this case, following Farquhar v. National Harrow Company, 102 Fed. 714, 42 C. C. A. 600, 49 L. R. A. 755, Adriance Platt & Co. v. National Harrow Co., 121 Fed. 827, 58 C. C. A. 163, and Emack v. Kane (C. C.) 34 Fed. 46, distinguishing the case of Francis v. Flinn, 118 U. S. 385, 6 Sup. Ct. 1148, 30 L. Ed. 165. Therefore it only remains to determine whether the proofs sustain the substantial averments of the bill.

At the outset we are met by this strange situation: Although both parties claim to have been manufacturing under letters patent, and the fact that complainant's supposed infringement has been well known to defendant for more than five years before this suit was brought, no effort has been made by it to establish its monopoly or to check the alleged infringement in the usual, orderly way. No suit has been brought against Dittgen, or against any user of his product. This circumstance goes far to impeach the good faith of representations made by defendant to the trade that complainant during all these years has been encroaching upon the claims of its patents.

The proofs now before the court render this conclusion of bad faith irresistible. Defendant is brought before a court of equity to answer for alleged false and malicious representations to complainant's customers as to its monopoly, and to answer complainant's contention that he has been operating lawfully under his own patent, and that he

has not infringed any claim of defendant's patents. Under these circumstances the defendant omits to offer in evidence either its own letters patent or that of complainant. It surrenders the basic contention. Furthermore, it is admitted by Parmenter, the general manager of defendant, that he frequently discussed with the trade the effect of a certain interference in the Patent Office; but no proof is offered to show that any such interference was ever declared, or ever decided, much less what patents or points were involved therein. In this state of the record we are forced to the conclusion that whatever claims of monopoly were made by defendant, and all charges of infringement against complainant, were falsely and maliciously made.

Another significant circumstance in the same line is that under date of April 23, 1902, complainant wrote defendant complaining of its methods and of the false representations it was making to the trade. He inclosed a sample of the pouch that he was manufacturing, for its inspection, and requested defendant, if it still thought that there was an infringement, to bring suit, and he would accept service in any court having jurisdiction. He also denounced them as "bluffers" if they dared not accede to his proposition. This letter elicited no response, except that Mr. Parmenter was away from home. Therefore defendant has practically left itself in this attitude on the record: That it was seeking to secure a practical monopoly by a system of commercial compulsion; that the process of the court was unnecessary if by its own processes it could stampede the customers of its sole competitor and secure the business for itself. The only resource left for defendant seems to have been a general denial, and we have only to settle the question of fact.

Parmenter, business manager of defendant, takes the stand and practically denies everything, except that he discussed with the trade the matter of an interference in the Patent Office. He denies that he employed threats of litigation. He is confronted by a multitude of witnesses, who appear to be disinterested, who assert the truth of the statements made in a large number of letters produced in evidence, which were written in the ordinary course of business, relating conversations with Mr. Parmenter and other of defendant's salesmen, wherein they threatened suits against any users of complainant's pouches. Not only this, but he is virtually contradicted by his own letters, written to the complainant, wherein are clearly displayed the weapons and methods to be employed in the crusade against complainant. His letters, written in 1900, under date of February 26th, May 22d, 25th, and 28th, June 5th, and December 18th, are bristling with threats of litigation and "peremptory measures" unless complainant will cease to infringe the defendant's patent. His hostile purpose, thus openly avowed, would naturally give color to his efforts to influence complainant's customers. The correspondence introduced in evidence here must convince any candid person that some one has for several years carried on a vigorous campaign directed against complainant, and that it has been in large measure successful. Numerous instances are given where orders that had been placed with complainant were countermanded because of the threats of Parmenter and

other salesmen of defendant. The effort seems to have been successful so far as to disseminate a general fear among the trade and a general impression that an injunction suit had already been brought against Dittgen, so that it would be hazardous for any dealer to buy the complainant's product. A naked denial is not persuasive against such a showing as is made by complainant's proofs.

In fixing the responsibility for the wide-spread consternation of the trade, matters are simplified by the fact that there were but two competitors in the field. There was no one, aside from defendant, who is shown to have any motive for diverting the trade of complainant. For the same reason it was unnecessary for the defendant's salesmen to assail the complainant by name. The work could be more safely and effectively done by vague insinuations, exciting fear of customers lest they subject themselves to an attack by defendant, armed and equipped with a number of patents. The studied instructions to salesmen, sworn to by them, indicate the skill with which the campaign was managed so as to leave no trace of malice in the letter book, or formal instructions.

It is the settled policy of the courts to restrain the illicit use of letters patent to maliciously injure the trade of competitors, whether the methods chosen are a multiplicity of suits brought against users to inspire terror and divert the trade (*Commercial Acetylene Co. v. Avery Co.* [C. C.] 152 Fed. 642), or circulars maliciously and persistently distributed among the trade threatening suit against all users of the alleged infringement, not for the legitimate purpose of giving notice of the patentee's claims, but to terrify the customers of the alleged infringer. The same remedy is appropriate and may be necessary when the patentee avoids any adjudication and shuns the court entirely, thus denying all opportunity to attack his patents or to secure a ruling on the question of infringement, while at the same time he enforces his monopoly by a systematic crusade among the customers of his competitor, threatening suit and dire consequences unless his claims under his patent are respected.

Letters patent should not be used as the Chinese formerly employed a horrible image to frighten an enemy. If such a campaign be skillfully conducted for a series of years, as seems to have been the case here, the competitor is helpless. His orders are countermanded, old customers desert him through fear of litigation, or demand bond of indemnity as a condition for placing orders. His business is melting away. Everywhere the trade is apprehensive of "peremptory measures" if they buy goods of an infringer. He appeals to the patentee to bring suit, and offers to enter an appearance in any court having jurisdiction, but all to no purpose. Customers will not listen to his explanations or denials, and, unless he can get relief in a court of equity, his business, which represents 20 years of effort, may be entirely ruined by a competition which is malicious and unfair. These are, in brief, the considerations which underlie the ruling of Judge Seaman on the demurrer, as I understand it. See, also, *Warren Co. v. Landauer* (C. C.) 151 Fed. 130.

It remains to consider the plea of the statute of limitations, which was interposed by way of amendment after the close of the proofs, as to any alleged cause of action which arose during the period when the Racine Paper Goods Company was a copartnership, and antecedent to the formation of the defendant corporation. The question arises in this way: "The Racine Paper Goods Company" was a copartnership up to January 4, 1902, when it was converted into a corporation, retaining the same name, carrying on the same business, inheriting the same assets, consisting of the same persons, and, unfortunately, continuing the same business methods. The corporation assumed all the debts and liabilities of the copartnership. Both bill and answer, as originally framed, proceed upon the theory that the Racine Paper Goods Company had from the beginning been a continuing corporation. Proofs were taken on both sides covering the transactions anterior to 1902, without objection; but before the proofs were actually closed the real facts, as above stated, were disclosed. Thereupon complainant obtained leave to amend the bill. At the same time the defendant obtained leave by consent to amend the answer as above recited. The proofs show that the corporation assumed the liabilities of its predecessor, the partnership. The theory of the defense now is that the statute continued to run until the bill was amended.

Under the authorities the question is whether the amendment asserted a new cause of action not contemplated by the original bill, or whether it was a mere explanation or amplification of the original cause of action. The law is well settled by Judge Sanborn, speaking for the Court of Appeals of the Eighth Circuit, in *Patillo v. Allen-West Co.*, 131 Fed. 680, 65 C. C. A. 508:

"The rule of law upon this subject is that an amendment to a petition which sets up no new cause of action or claim, and makes no new demand, but simply varies or expands the allegation in support of the cause of action already propounded, relates back to the commencement of the action, and the running of the statute so pleaded is arrested at that point; but an amendment that introduces a new or different cause of action, and makes a new or different demand, not before introduced or made in the pending suit, does not relate back to the beginning of the action, so as to stop the running of the statute, but is the equivalent of a fresh suit upon a new cause of action, and the statute continues to run until the amendment is filed."

The following cases, cited by complainant's solicitor, seem to bear out the doctrine above announced: *Tremaine v. Hitchcock*, 23 Wall. 518, 23 L. Ed. 97; *Johnson v. Waters*, 111 U. S. 640, 4 Sup. Ct. 619, 28 L. Ed. 547; *Hardin v. Boyd*, 113 U. S. 756, 5 Sup. Ct. 771, 28 L. Ed. 1141; *Texas Pacific Ry. v. Cox*, 145 U. S. 593, 12 Sup. Ct. 905, 36 L. Ed. 829; *Richmond v. Irons*, 121 U. S. 27, 7 Sup. Ct. 788, 30 L. Ed. 864.

The theory of the original bill was that the defending corporation was liable for the unfair competition practiced during the entire period. This theory was acquiesced in by both parties sub silentio, in both pleading and proofs. Prior to this amendment there is not in the record any suggestion that defendant's liability was limited by reason of its former existence as a copartnership. When the fact of such former existence cropped out in evidence, the complainant saw fit to

amend and state the facts of assumption by the corporation of all liabilities of the firm. It amounted to an amplification of the averments, which, perhaps, was not necessary, but certainly was proper; but it did not change the attitude of the parties, or bring in any new cause of action within the meaning of the rule. Under the original pleadings the identity and liability of the Racine Paper Goods Company was assumed throughout. The amendment suggests circumstantially the reason why such original assumption was just and equitable. The amendment to the bill was made by consent of parties to make the bill conform to the proofs. I am persuaded, therefore, that the running of the statute was arrested by the bringing of the suit.

Without reciting the evidence more in detail, I am driven to the conclusion that defendant has been guilty of unfair competition and has thereby maliciously diverted and injured the trade of complainant; that against such unfair methods complainant could obtain no adequate remedy in the courts of law; that he has sustained substantial loss in his business, and is therefore entitled to an injunction and an accounting as prayed.

An interlocutory decree will be prepared in accordance with this opinion.

HOBBS MFG. CO. v. GOODING et al.

(Circuit Court, D. Massachusetts. June 1, 1908.)

No. 448.

COURTS—JURISDICTION OF FEDERAL COURTS—ANCILLARY SUITS.

A federal court, which has rendered a judgment in favor of a plaintiff in a suit within its jurisdiction, has jurisdiction of a creditor's bill filed by the plaintiff to set aside fraudulent conveyances of property by defendant which prevent the collection of such judgment as ancillary to the first suit, without regard to the citizenship of the parties.

[Ed. Note.—Supplementary and ancillary proceedings and relief in federal courts, see note to Toledo, St. L. & K. C. R. Co. v. Continental Trust Co., 36 C. C. A. 195.]

In Equity. On motion to dismiss for want of jurisdiction:

Edward S. Beach, for complainant.

Elder & Whitman, for defendant Sarah E. Glazier.

C. F. Weed and A. H. Weed, for defendants Geo. W. Glazier, Mary F. Lord, Charles C. Briggs, John C. Metcalf, Flora A. Tyler, J. C. Metcalf Paper Box Machine Co., George L. Metcalf Wood & Paper Box Company, and Levi C. Wade.

Wm. A. Macleod, for defendant George P. Dike.

Raymond T. Parke, for defendants Eugene H. Taylor and George E. Gooding.

Charles Warren, for defendant John T. Robinson Company.

LOWELL, Circuit Judge. The complainant, a citizen of Massachusetts, brought a bill in equity (hereinafter called the first bill) to restrain the infringement of a patent, and obtained a final decree for

the payment of the sum of \$15,000. Execution was taken out thereupon, and the officer's return was as follows:

"Pursuant hereunto I, on the 7th day of February, 1908, attached one (1) share of capital stock of the John T. Robinson Company, Massachusetts corporation, standing in the name of the within-named Eugene H. Taylor, and on the same day and at the same time I attached one (1) share of stock in the said John T. Robinson Company standing in the name of the within-named George E. Gooding, and I have given in hand to J. Albert Robinson, treasurer and clerk of said corporation, at Hyde Park, a true and attested copy of this execution for both Gooding and Taylor, and so much of my return indorsed thereon as relates to the attachment of said stocks. I also made search for any property belonging to the within-named defendants in Lynn, Salem, and Hyde Park, and was unable to find any. Therefore I return this execution into court unsatisfied.

"J. H. Waters, Deputy U. S. Marshal."

Thereupon the complainant brought a bill (hereinafter called the second bill), setting out the facts above stated, and alleging that sundry defendants to the first bill had conveyed their property for the purpose of defrauding the complainant creditor. The second bill prayed that the conveyances be set aside, and that the execution be satisfied. Some of the alleged fraudulent grantees, being citizens of Massachusetts, and others being citizens of other states, were made parties to the second bill. Some of the defendants to the second bill have moved to dismiss it, upon the ground that this court is without jurisdiction thereof, inasmuch as the complainant and some of the defendants are alike citizens of Massachusetts.

The first bill, which sought the protection of patent rights, was properly brought in the Circuit Court, inasmuch as it raised a federal question. Considered by itself, the second bill now before the court is substantially an ordinary creditor's bill, and raises no federal question. The complainant contends, however, that the court has jurisdiction of this creditor's bill, inasmuch as it is ancillary or supplemental to the first bill to restrain infringement. The complainant urges that diversity of citizenship is therefore not necessary to sustain this court's jurisdiction.

Most of the cases cited by the complainant fail to support the jurisdiction of the court. They show merely that the federal court is not without jurisdiction of an ancillary or supplemental bill to revive an original bill, to restrain a suit pending in the same court, to modify a decree or judgment therein, to dispose of a res in the court's possession, and the like. They give no support to the proposition that, because a federal court has obtained jurisdiction of a controversy in which the complainant holds an unsatisfied execution for damages, the court has therefore jurisdiction of a creditor's bill to satisfy this execution by reaching property which has been conveyed by the defendant in fraud of his creditors. To take jurisdiction of the case at bar involves the right to entertain such a bill in every case.

But in *Dewey v. West Fairmont Gas Co.*, 123 U. S. 329, 8 Sup. Ct. 148, 31 L. Ed. 179, the Supreme Court sustained federal jurisdiction in a case like that at bar. The record and briefs in that case have been examined. A., a citizen of New York, brought an action against B., a citizen of West Virginia, alleging that B., as vendee, refused

to carry out a contract of sale. The cause was removed into the Circuit Court of the United States. B. thereupon filed a bill in equity in that court, alleging that the goods delivered did not come up to sample, seeking damages, praying an injunction against further proceedings at law, and further praying that A.'s assets, fraudulently assigned to C., might be subjected to the payment of B.'s claim. C. was a citizen of West Virginia, and objected to the jurisdiction of the court, inasmuch as there was no diversity of citizenship between B. and C. The Supreme Court sustained the jurisdiction, however, and observed:

"The suit in equity was an exercise of jurisdiction on the part of the Circuit Court ancillary to that which it had already acquired in the action at law, which it might well entertain according to the rule adjudged in *Krippendorf v. Hyde*, 110 U. S. 276, 4 Sup. Ct. 27, 28 L. Ed. 145, and *Pacific Railroad Co. v. Missouri Pacific Railway Co.*, 111 U. S. 505, 4 Sup. Ct. 583, 28 L. Ed. 498." *Dewey v. West Fairmont Gas Co.*, 123 U. S. 333, 8 Sup. Ct. 148, 31 L. Ed. 179.

See *Home Ins. Co. v. Virginia-Carolina Chemical Co.* (C. C.) 109 Fed. 681, 687; *Virginia-Carolina Chemical Co. v. Home Ins. Co.*, 113 Fed. 1, 3, 51 C. C. A. 21.

The Dewey Case was referred to in *Campbell v. Golden Cycle Mining Co.*, 141 Fed. 610, 613, 73 C. C. A. 260, decided by the Circuit Court of Appeals for the Eighth Circuit, to sustain the proposition that:

"A party to an action at law may successfully exhibit a dependent bill to avoid fraudulent conveyances made to prevent the collection of his claim from his debtor, who was a party to the original action."

Moreover, in *White v. Ewing*, 159 U. S. 36, 15 Sup. Ct. 1018, 40 L. Ed. 67, the Supreme Court referred to the Dewey Case to support the proposition that a federal court, having appointed receiver of a corporation under a creditor's bill founded upon diversity of citizenship, thereby acquired jurisdiction of all suits brought by the receiver to collect the corporate assets, irrespective of the citizenship of the parties. The last-mentioned case extends far the application of the doctrine for which the complainant contends.

In *Minnesota Co. v. St. Paul Co.*, 2 Wall. 609, 633, 17 L. Ed. 886, the Supreme Court said:

"But we think that the question is not whether the proceeding is supplemental and ancillary or is independent and original, in the sense of the rules of equity pleading, but whether it is supplemental and ancillary or is to be considered entirely new and original, in the sense which this court has sanctioned with reference to the line which divides the jurisdiction of the federal courts from that of the state courts. No one, for instance, would hesitate to say that, according to the English chancery practice, a bill to enjoin a judgment at law is an original bill in the chancery sense of the word. Yet this court has decided many times that when a bill is filed in the Circuit Court, to enjoin a judgment of that court, it is not to be considered as an original bill, but as a continuation of the proceeding at law."

It has been argued that the second bill cannot be taken to be ancillary to the first, because a final decree has been entered in the first bill, and so it is completely disposed of; but here a final decree in the first bill is necessarily a condition precedent to the filing of the second,

and, in other cases where the later bill has been deemed ancillary, the first bill has first been completely disposed of. Upon the whole, though with considerable doubt, I am of the opinion that the second bill, so called, is ancillary to the first, and that this court has jurisdiction to entertain it.

Having decided that the controversy here presented is within its jurisdiction, the court must next consider the particular defenses and objections raised by the several defendants. Their several motions to dismiss for want of jurisdiction are denied. In so far as these motions are not based exclusively upon a lack of federal jurisdiction, they cannot now be considered, inasmuch as the special appearance of the several defendants limits them to this defense. It is not to be supposed that they intend the other objections which they make to the bill as having the effect of a general appearance, and so of a waiver of their objections to the jurisdiction. The demurrers of some of the defendants styled "special demurrers" are not confined to jurisdictional matters, and so cannot be considered under a special appearance. These observations dispose of the case as presented at the hearing.

Ordered: All motions to dismiss for want of jurisdiction denied.

CUSHMAN v. ATLANTIS FOUNTAIN PEN CO. et al.

(Circuit Court, D. Massachusetts. July 23, 1908.)

No. 406.

COURTS—EQUITY JURISDICTION OF FEDERAL COURTS—JURISDICTION OF ENTIRE CONTROVERSY.

A bill to restrain the infringement of a patent, which thus presents a federal question, does not draw within the jurisdiction of the Circuit Court a further issue as to unfair competition in trade, although it grows out of the same acts of defendant; the two causes of action being independent of each other.

In Equity. On motion for preliminary injunction.

William Quinby, for complainant.

Ellis Spear, Jr., for defendants.

LOWELL, Circuit Judge. This is a bill in equity, which sets out the infringement of a patent for pens and an alleged unfair use of the complainant's trade-name for the same purpose. The complainant asks a preliminary injunction, which has been issued, to restrain the infringement of the patent. Has the court jurisdiction to deal with the alleged unfair competition?

That the Circuit Court is without jurisdiction of a bill brought solely to restrain unfair competition is settled by *Elgin National Watch Co. v. Illinois Watch Case Co.*, 179 U. S. 665, 21 Sup. Ct. 270, 45 L. Ed. 365, and *Leschen Co. v. Broderick Co.*, 134 Fed. 571, 67 C. C. A. 418, the latter case decided by the Circuit Court of Appeals for the Eighth Circuit. The complainant contends, however, that a bill to restrain the infringement of a patent, which thus pre-

sents a federal question, draws within the jurisdiction of the Circuit Court the proceeding to restrain unfair competition, with which the patent in suit is connected, and of which it may be deemed a part.

That a suit properly brought in the Circuit Court sometimes brings within the jurisdiction of that court matters which would be without that jurisdiction in the absence of the original proceedings, is well established. *White v. Ewing*, 159 U. S. 36, 15 Sup. Ct. 1018, 40 L. Ed. 67; *Hobbs v. Gooding*, 164 Fed. 91. The federal jurisdiction sometimes remains after the principal controversy has been disposed of; but the scope of the rule is limited, and the case at bar is outside it. The defendant's acts complained of in the patent suit and in the suit to restrain unfair competition are doubtless the same; but their legal aspect is different from the two points of view, and the two causes of action are independent. This is the conclusion reached in *King v. Inlander* (C. C.) 133 Fed. 416.

Motion to enjoin alleged unfair competition denied for want of jurisdiction.

WHELAN v. ENTERPRISE TRANSP. CO.

(Circuit Court, D. Massachusetts. July 20, 1908.)

No. 405.

1. COURTS—FEDERAL COURTS—FEDERAL JURISDICTION.

Where federal jurisdiction attaches at law at the same time jurisdiction attaches for some purpose in equity, and vice versa.

2. RECEIVERS—CLAIMS—NATURE OF PROCEEDINGS.

Where a receiver for a corporation was appointed by a bill of equity in the federal courts, the receiver thereby did not become entitled to maintain a petition in such suit in the nature of a plenary bill in equity against a person not a party to the receivership proceedings, to recover on a purely legal demand; the receiver's remedy in the federal Circuit Court at law being adequate.

3. JURY—RIGHT TO JURY TRIAL—WAIVER—CLAIMS AGAINST RECEIVER.

That a creditor of an insolvent corporation, for which a receiver had been appointed in equity, filed a claim against the estate, did not constitute a waiver of the claimant's right to a jury trial in a proceeding brought by the receiver against the claimant, not by way of set-off, but to recover a purely money demand.

In Equity.

On plea of Holt and others to petition of receiver and on motion to dismiss.

Albion L. Millan and Morse & Friedman, for intervening creditor Van Raalte.

Brandeis, Dunbar & Nutter, for Beadleston and Woez.

Dickinson & Dickinson and Saml. Williston, for receiver.

LOWELL, Circuit Judge. The receiver, appointed by this court, filed a petition in this court which, by the stipulation of parties, may be taken to be the equivalent of a plenary suit in equity ancillary to the principal receivership suit. The petition set out that the defendant Paige, an insurance agent, had collected payment under insurance

policies for certain losses suffered by the corporation. The sums thus collected he refused to turn over to the receiver, alleging that he was entitled to keep them and apply them in satisfaction of his claim against the corporation for unpaid premiums advanced to it by him. This last-mentioned claim he has duly filed in the principal suit, seeking payment thereof from the estate. To the petition, treated as a bill in equity of some sort, he has demurred, upon the ground that the proceeding by way of petition denies him his right of jury trial. He also urges that the receiver has an adequate remedy at law. The receiver admits that his claim against Paige is not in its nature cognizable in equity. He makes the following contention in support of his petition:

That in *White v. Ewing*, 159 U. S. 36, 15 Sup. Ct. 1018, 40 L. Ed. 67, the appointment of a receiver in a proceeding of which the federal court has rightly taken jurisdiction was held to give to that court jurisdiction to collect, by way of proceedings in equity, all claims of the receiver against the corporation's debtors. In other words, that the due appointment of a receiver by a court of equity gives to that court jurisdiction to proceed in equity to collect any and all of the receiver's claims, though against persons not parties to the original bill. Counsel for Paige contends, on the other hand, that *White v. Ewing* must be taken to hold that the jurisdiction conferred upon the Circuit Court by the receiver's appointment is conferred upon that court generally, and not upon the Circuit Court only as a court of equity. Paige admits the jurisdiction of the Circuit Court to enforce this claim by way of a common-law suit, and bases his demurrer to the petition solely upon the procedure in equity sought by this petition, and upon its consequent denial of jury trial. The receiver, in effect, asserts that, as the proceedings originated in equity, they must remain equitable. He does not deny that a court of equity may frame issues for trial at law and send them to a court of law for trial. That is a well-recognized function of a court of equity. He does deny that the jurisdiction of a court of equity can extend the jurisdiction of a court of law in a manner unknown to the principles of English chancery. Hence he contends that the proceedings to collect the receiver's claims, termed ancillary in *White v. Ewing*, must necessarily be equitable.

Paige is not satisfied to seek a jury trial from the chancellor's discretion, though he is ready to meet it in a federal court. His contention, in effect, is this: If the receiver here brings an action at law against Paige, he needs no justification for the form of this action. He alleges money had and received by Paige to his use. A court of law is the proper forum for the receiver's recovery. So far all is clear. To maintain his action at law in the Circuit Court, as Paige asserts that he may, not only must the receiver have a claim enforceable in an action at law, but the federal court, as such, must have jurisdiction to entertain the action. We thus pass from the general principles of the common law and from the practice of the English Court of Chancery to the nature and limits of federal jurisdiction.

In our jurisprudence, the courts of common law and of equity are interdependent. Neither is complete without the other. Legal remedies may be ineffective or too harsh, unless strengthened or soft-

ened by the more flexible procedure of equity. The judgments of a court of law must sometimes be modified by a court of equity. Now if federal jurisdiction, once attached at law, did not at the same time attach for some purposes in equity, and vice versa, our federal courts would be less efficient instruments of justice than other courts of English speaking people. Accordingly, the Supreme Court held, in *Dunn v. Clarke*, 8 Pet. 1, 8 L. Ed. 845, that the Circuit Court had jurisdiction to restrain, without regard to citizenship, the devisee of a plaintiff from enforcing a judgment obtained by the latter at law. "The injunction bill is not considered as an original bill between the same parties as at law." 8 Pet. 3, 8 L. Ed. 845. Yet in the purview of an English Court of Chancery such a bill would undoubtedly be original. *Minnesota Co. v. St. Paul Co.*, 2 Wall. 609, 633, 17 L. Ed. 886. It was ancillary only quo ad federal jurisdiction. *Home Ins. Co. v. Virginia-Carolina Chem. Co.* (C. C.) 109 Fed. 681, 686.

The principle that, where a federal court acquires jurisdiction of a controversy by proceedings either at law or in equity, it acquires jurisdiction of the controversy for the purpose of further proceedings both at law and in equity, was further established by the cases referred to in *White v. Ewing*. Thus it was said, in *Krippendorf v. Hyde*, 110 U. S. 276, 287, 4 Sup. Ct. 27, 32, 28 L. Ed. 145:

"The form of the proceeding, indeed, must be determined by the circumstances of the case. If the original cause, in which the process has issued or the property or fund is held, is in equity, the intervention will be by petition pro interesse suo, or by a more formal but dependent bill in equity, if necessary. Relief, either in a suit in equity or an action at law, may properly be given, in some cases, in a summary way, by motion merely, supported by affidavits. In actions at law, where goods have been taken in execution after judgment, or upon attachment before, a proceeding in the nature of an interpleader might be appropriately ordered by the court, such as was given in the English practice to the officer by St. of 1 & 2 Will. IV, c. 58 (2 Lush's Pr. by Dixon, 777), and in that the respective rights of the claimants to the property could generally be tried, as in an action at law, by a jury, upon a formal issue framed for that purpose, or with the consent of the parties by the court, or, if the claim was such as that it could be determined only upon principles of equity, as administered in courts of that general jurisdiction, it would be proper to provide relief upon a bill of that nature, filed for that purpose. If the statutes of the state contained provisions regulating trials of the right of property in such cases, it might be most convenient to make them a part of the practice of the court, as contemplated by sections 914, 915, and 916 of the Revised Statutes (U. S. Comp. St. 1901, p. 684). In whatever form, however, the remedy is administered, whether according to a procedure in equity or at law, the rights of the parties will be preserved and protected against judicial error, and the final decree or judgment will be reviewable, by appeal or writ of error, according to the nature of the case."

The controversy thus brought within the federal jurisdiction, both legal and equitable, has been extended in some cases to include persons not parties to the original action at law or to the bill in equity. Here we are not concerned, as in *Hobbs v. Gooding*, 164 Fed. 91, with the limits of the controversy over which the federal court acquires jurisdiction at law and in equity. Here it is admitted that the Circuit Court, either as a court of law or as a court of equity, has jurisdiction of proper proceedings to enforce the receiver's claim

against Paige. That the collection of this claim, even against Paige, who was not a party to the original bill, is yet so far ancillary to the original bill and so far a part of the controversy with which the original bill dealt that the federal court has jurisdiction, is conceded by Paige. The court has to determine only if the proceeding which is styled by the Supreme Court ancillary to bills in equity is necessarily equitable or, in an appropriate case, may be an action at law. The cases cited establish that, in this sense, a bill in equity may be ancillary to an action at law, and the converse seems to follow. If the Circuit Court has jurisdiction of an action at law by the receiver to collect this claim, his remedy at law is adequate. The question hitherto discussed must be answered in favor of Paige.

This conclusion avoids the unpleasant consequences which Paige suggested in argument. To-day B. owes A. a sum of money. B. can be sued only at law. To-morrow C. is appointed receiver of A. and proceeds against B. in equity. B.'s right to a jury trial has disappeared. The receivership suit may have been collusive in order to oust B. of his right. B., it seems, cannot raise this objection. Instead of asserting a right, he must apply to the discretion of the chancellor.

It is urged by the receiver that in *White v. Ewing* the receiver's claim was legal in its nature, as in the case at bar, and that the receiver was allowed to proceed in equity. The Supreme Court said, however:

"No exception was taken to the form of the bill by demurrer or otherwise," and "the question certified does not, as we understand it, demand the opinion of this court as to whether a single bill against all these defendants would lie for the amounts severally due by them (upon which point we do not feel called upon to express an opinion): but whether, so far as in said suit the receiver claimed the right to recover from any one debtor a sum not exceeding \$2,000, the court had jurisdiction to render a judgment against them." 159 U. S. 38, 15 Sup. Ct. 1018, 40 L. Ed. 67.

The precise question here raised was decided by the Circuit Court of Appeals for the Sixth Circuit in *Peck v. Elliott*, 79 Fed. 10, 24 C. C. A. 425, 38 L. R. A. 616, and in *Cunningham v. Cleveland*, 98 Fed. 657, 660, 39 C. C. A. 211, and was there decided in favor of the receiver. It was also decided in *Eauclaire v. Payson*, 109 Fed. 676, 48 C. C. A. 608, in the Circuit Court of Appeals for the Seventh Circuit, and was there decided in favor of the contention here made by Paige. This court follows the latter decision for the reasons above stated, and holds that the jurisdiction over the controversy acquired by filing the original bill in equity extends to an action at law brought in the Circuit Court to enforce the receiver's claim. If this be true, both sides admit that *White v. Ewing* is not conclusive in the receiver's favor.

The court has next to consider if the fact that Paige filed a claim against the estate in the hands of a receiver appointed by a court of equity brings him within the jurisdiction of that court of equity for the purpose of the collection of the receiver's claim against him. That Paige cannot obtain as matter of right a jury trial concerning his claim against the estate may be admitted, but from this it does not follow that he waives his right to a jury trial in case of a claim brought

by the receiver against him, where that claim is made, not by way of set-off, but for the purpose of taking money out of Paige's pocket. Upon the whole, I think that Paige is right in this contention also.
Demurrer sustained.

LOTHROP et al. v. UNITED STATES.

(Circuit Court, D. Massachusetts. July 27, 1908.)

No. 236 (1,941).

CUSTOMS DUTIES—SUFFICIENCY OF PROTEST.

Under Customs Administrative Act June 10, 1890, c. 407, § 14, 26 Stat. 137 (U. S. Comp. St. 1901, p. 1933), prescribing that protests shall set forth "distinctly and specifically" the importer's objections, a protest is sufficient which, though imperfectly expressed, may be understood when read in connection with the statute referred to therein; and the fact that the collector understood the protest is relevant.

On Application for Review of a Decision by the Board of United States General Appraisers.

The decision below overruled protests by L. D. Lothrop and J. H. Rowe Company against the assessment of duty by the collector of customs at the port of Boston. The opinion filed by the Board of General Appraisers reads as follows:

Fischer, General Appraiser. The merchandise to which these protests relate consists of fishhooks made from round iron or steel wire, upon which duty was assessed at the rate of 40 per cent. ad valorem and 1¼ cents per pound under the provisions of paragraph 137 of the tariff act of 1897 (Act July 24, 1897, c. 11, § 1, schedule C, 30 Stat. 161 [U. S. Comp. St. 1901, p. 1639]). The claim in the protest is set forth in the following language:

"We (or I) claim that as the wire in said hooks is valued at less than four (4) cents per pound, that duty should only be paid under the first section of said paragraph 137, and no add-valorem duty be collected."

It is not necessary to go into the merits of the question of classification attempted to be raised by these protests, for they are fatally defective and insufficient, and, even if the assessment of duty made by the collector be erroneous, no relief can be afforded the importers.

The protests arise under the same paragraph (137), and they have substantially the same defects, with one in addition, as those which were overruled as insufficient by the Circuit Court in the case of Boker & Co. v. United States, 140 Fed. 115, T. D. 26,451, affirming the ruling of the board in G. A. 5,879 (T. D. 25,892). On further appeal, the decision of the lower court and the board was affirmed without opinion, 145 Fed. 1022, 74 C. C. A. 681, T. D. 27,192. In his opinion Judge Townsend said:

"The paragraph is a long one. The protest fails to state on what ground the objection is made, or what rate of duty is claimed. It is, therefore, insufficient within the rule that 'the importer shall set forth in his protest distinctly and specifically the reasons for his objection to the assessment.'"

These remarks apply precisely to the protests now before us. The claim is "that duty should only be paid under the first section of said paragraph 137," but there are no less than three different rates of duty prescribed in the first section. Such a protest does not apprise the collector of just what the importer's claim is.

This is not a mere captious criticism, nor is it a rigorous exaction of technical precision. The rates prescribed in the opening clause of paragraph 137 depend on the gauge of the wire, and the gauge of the wire is a fact that is peculiarly within the knowledge of the importer. It is, then, no hardship to require him to state it in his protest, for without such information the

liquidating officer would be helpless. There are before us now for decision several protests involving the rate of duty on fishhooks, which will be sustained because they point out the particular rate of duty claimed for each class of hooks, and the proof offered is sufficient to show that there was error on the part of the classifying officer, and that the importer has made the correct claim, an indication that the rule we here enunciate does not call for the performance of an impossibility. Note G. A. 6,494 (T. D. 27,764).

Another and an even more serious objection to the success of the importers' contention is that under no circumstances could fishhooks, no matter of what grade or gauge of wire, be held dutiable under this so-called first section. Fishhooks are "articles manufactured from wire," and these are specially provided for in the second proviso to paragraph 137 at a rate different from the rate imposed upon wire.

In our opinion, these protests are not a sufficient compliance with the statute (Act June 10, 1890, c. 407, § 14, 26 Stat. 137 [U. S. Comp. St. 1901, p. 1933]), and they are hereby overruled. The decision of the collector in each case will stand.

Comstock & Washburn and Searle & Pillsbury (Albert H. Washburn, of counsel), for importers.

William H. Garland, Asst. U. S. Atty.

LOWELL, Circuit Judge. The petitioner imported fishhooks which were assessed for duty at $1\frac{1}{4}$ cents per pound, and 40 per cent. ad valorem. Against the payment of this duty he protested as follows:

"I hereby protest against the payment of a duty of one and one quarter ($1\frac{1}{4}$) cents per pound and 40% add-valorem [ad valorem] on certain Fish Hooks, under paragraph 137 of the Tariff, 1897.

"These hooks were imported into Boston, Dec. 23rd, 1905, from England and brought into this district under Immediate Transportation, Entry No. 3,226, and entered for consumption here, Entry No. 70, dated Dec. 27th, 1905.

"I claim that as the wire in said Hooks cost less than four cents (4¢) per pound, that duty should only be paid under the first section of said paragraph 137, and no add-valorem [ad valorem] duty collected."

The Board of General Appraisers sustained the collector, upon the ground that the protest was insufficient. It is admitted that the goods were dutiable under paragraph 137 of the Dingley act, which reads as follows:

"Round iron or steel wire, not smaller than number thirteen wire gauge, one and one-fourth cents per pound; smaller than number thirteen and not smaller than number sixteen wire gauge, one and one-half cents per pound; smaller than number sixteen wire gauge, two cents per pound: Provided, that all the foregoing valued at more than four cents per pound shall pay forty per centum ad valorem. Iron or steel or other wire not specially provided for in this act, including such as is commonly known as hat wire, or bonnet wire, crinoline wire, corset wire, needle wire, piano wire, clock wire, and watch wire, whether flat or otherwise, and corset clasps, corset steels and dress steels, and sheet steel in strips, twenty five one thousandths of an inch thick or thinner, any of the foregoing, whether uncovered or covered with cotton, silk, metal, or other material, valued at more than four cents per pound, forty-five per centum ad valorem: Provided, that articles manufactured from iron, steel, brass, or copper wire, shall pay the rate of duty imposed upon the wire used in the manufacture of such articles, and in addition thereto one and one-fourth cents per pound, except that wire rope and wire strand shall pay the maximum rate of duty which would be imposed upon any wire used in the manufacture thereof, and in addition thereto one cent per pound; and on iron or steel wire coated with zinc, tin, or any other metal, two tenths of one cent per pound in addition to the rate imposed on the wire from which it is made."

The collector imposed a duty (1) of $1\frac{1}{4}$ cents per pound for the wire; (2) $1\frac{1}{4}$ cents per pound additional for the manufacture; and (3) 40 per cent. ad valorem. It is not disputed that (1) and (2) were correctly imposed, nor that the importation should have been admitted without payment of (3). The collector's mistake in adding (3) is conceded.

The United States contends that the protest did not set out distinctly and specifically the reasons for the importer's objections to the collector's liquidation. It contends, in effect, that the protest was unintelligible. But, if the protest be read in connection with the paragraph cited therein, its meaning is plain, notwithstanding its imperfect expression. The importer's protest was against an ad valorem duty upon fishhooks, imposed because the wire in the hooks cost more than four cents per pound. The protest alleged that the wire cost less than 4 cents per pound. If so, no ad valorem duty was payable, and the wire fishhooks were made liable only to a specific duty. If the collector had had before him nothing but the protest and paragraph 137, I believe that he could not reasonably have failed to know the grounds of the importer's objection to the liquidation.

If this is true, it is not necessary to consider how far the court may take into account that the collector knew in fact perfectly well what the protest meant. If the object of the protest be to notify the collector of the true nature and character of the importer's objection, the fact that the collector understood the protest would seem to be relevant. This view of the law appears to be borne out by the language of the opinions in *Schell v. Fauche*, 138 U. S. 562, 11 Sup. Ct. 376, 34 L. Ed. 1040; *Davies v. Arthur*, 96 U. S. 148, 24 L. Ed. 758; *Arthur v. Morgan*, 112 U. S. 495, 5 Sup. Ct. 241, 28 L. Ed. 825; *U. S. v. Salambier*, 170 U. S. 621, 18 Sup. Ct. 771, 42 L. Ed. 1167; *Burgess v. Converse*, 2 Curt. 216, Fed. Cas. No. 2,154; *In re Hagop Bogigian Co. (C. C.)* 104 Fed. 75. *U. S. v. Schefer (C. C.)* 71 Fed. 959, decided only that the collector has no authority to absolve the importer from the duty of filing a protest within the statutory period as the prerequisite of a refund of duties. The case did not decide that the collector's state of mind cannot be inquired into in order to determine if a protest is unintelligible to him. According to section 14 of the customs administrative act (Act June 10, 1890, c. 407, 26 Stat. 137 [U. S. Comp. St. 1901, p. 1933]), it is hard to see what authority the collector has to modify his liquidation after receipt of the protest, or, indeed, what he can do with the protest, except forward it immediately to the Board of General Appraisers. But undoubtedly the practice has always permitted reliquidation by the collector after the protest is received. By the customs administrative act that protest must, indeed, be filed after liquidation, but not necessarily after payment of the duties.

Whether we consider the language of the protest or the effect which it produced upon the collector's mind, the requirements of the act were met.

The judgment of the Board of General Appraisers is reversed.

In re NIAGARA RADIATOR CO

(District Court, W. D. New York. September 18, 1908.)

No. 2,591.

1. ASSIGNMENTS—RIGHTS ASSIGNABLE—EXECUTORY CONTRACTS.

An executory contract for future delivery of personal property, not dependent on future dealings with the property sold between the parties, is assignable, in the absence of any provision to the contrary, although it provides for a term of credit to be given the purchaser, provided the assignor offers to relieve the seller from giving such credit and to pay cash on delivery.

[Ed. Note.—For cases in point, see Cent. Dig. vol. 4, Assignments, § 25.]

2. BANKRUPTCY—ASSUMPTION OF CONTRACT BY RECEIVER—RIGHT TO ENFORCE.

The receiver appointed for a bankrupt manufacturing corporation was expressly authorized by the court to continue the business and to assume a contract under which the company was to receive monthly deliveries of iron ore, for which it was to have a credit of 30 days. Pursuant to such authority the receiver notified the seller that he assumed such contract and would make payment for the ore as delivered, and a similar notice was given by him after his appointment as trustee. *Held*, that he succeeded to all the rights of the bankrupt under such contract, and that the seller was liable in damages for a failure and refusal to make deliveries as required thereby.

In Bankruptcy.

This is a review of an order made by Referee Judson finding that the petitioner, Sloss-Sheffield Steel & Iron Company, was indebted to the bankrupt estate herein in the sum of \$10,296 as damages for failure to perform a contract made with the said bankrupt, Niagara Radiator Company, on September 16, 1906, for the delivery to it of 1,800 tons of iron ore in equal monthly deliveries during the first half of 1907 at the price stated in said contract, payment to be made 30 days after the shipment of each installment. Said order further provided that said amount of damages be set off against the claim of Sloss-Sheffield Steel & Iron Company of \$12,595.50 for moneys due from said bankrupt under previous contracts, and that said claim be reduced to and allowed at the sum of \$2,299. The receiver of said bankrupt, appointed by this court on January 8, 1907, was authorized to continue the business, to borrow money to conduct the business in a sum not exceeding \$25,000, and was expressly authorized to assume the contract hereinabove referred to, and to compel its performance. At the time the petition in bankruptcy was filed herein neither party to the contract was in default thereon, and the contract was in full force. On January 12, 1907, said receiver notified Sloss-Sheffield Steel & Iron Company in writing that he elected to assume and carry out said contract, and requested deliveries of the pig iron to him, and offered to pay cash on such deliveries. Said receiver was on March 9, 1907, duly appointed trustee of said bankrupt, and as such receiver and trustee made other demands for deliveries of ore as specified in the contract, but the vendor repudiated and refused to fulfill its said contract.

Kenefick, Cooke & Mitchell, Lyman M. Bass, and Edward E. Franchot, for petitioner.

Kellogg & Baker, for trustee.

HAZEL, District Judge (after stating the facts as above). The petitioner herein contends, first, that the contract is by its terms non-assignable, and any attempts by said receiver and trustee to assume the same were of no effect; and, second, admitting its assignability,

hat the contract was never assumed by said receiver, except as to the contract for the January shipment, and that the same was never assumed by the trustee.

I think the conclusion of the referee that the contract in question was assignable, and that under section 70a (5) of the bankrupt act (Act July 1, 1898, c. 541, 30 Stat. 565 [U. S. Comp. St. 1901, p. 3451]) the rights of the bankrupt under said contract passed to the trustee was correct. The insolvency of the Niagara Radiator Company did not abrogate the contract, and while the extension of 30 days' credit after delivery probably involved relationship of trust and confidence, yet at the present time contracts containing no express language prohibiting their assignment—contracts for future deliveries of personal property, and not dependent upon future dealings with the property sold between the parties—are assignable, provided the assignee stands ready to relieve the vendor from his obligation to make deliveries on credit and offers payment. Nothing is found in the stipulation of facts to indicate that the parties to the contract regarded that they had entered into a contract containing conditions specifically relating to the ore after delivery. Had it been their intention to enter into a nonassignable contract, they were called upon to provide in terms for its nonassignability, or incorporate therein words from which such intention could be reasonably implied, for the 30-day credit provision, standing alone, could not be considered as evidence of such an intention.

Importance is placed by the petitioner on the case of Arkansas Valley Smelting Co. v. Belden Mining Co., 127 U. S. 379, 8 Sup. Ct. 1308, 32 L. Ed. 246; but a careful reading of the opinion of the court convinces me that the facts of that case do not make it a controlling precedent. Indeed, the circumstances of the case clearly point out that the rights springing from the contract to deliver lead ore at the smelting works of the assignor were coupled with dealings of a personal nature, and from which it could fairly be assumed that the contracting parties, having confidence in each other, entered into the specified arrangement. Neither the price of the ore nor the time of payment was agreed upon, but one of the parties to the contract was to assay it, and in case of disagreement it was to be assayed by a third party, and to fix the price it became necessary that the proportion of lead, silver, silica, and iron in the ore first be ascertained. The pith of the decision is found in the statement of the court that the defendant had no security for the payment of the ore between the time of delivery and the ascertainment of the price, and hence there could be no substitution for the original contracting parties. Here we have an executory contract to make deliveries at a specified time, the price being stated, and 30 days' credit being given, unaccompanied by any peculiar circumstances or conditions.

I think the principle announced in the cases of Pardee v. Kanady, 100 N. Y. 101, 2 N. E. 885, and New England Iron Company v. Gilbert El. R. R. Co., 91 N. Y. 153, is applicable to the facts set forth in the stipulation. Here, as in those cases, the receiver and trustee were able and willing to assume the contract, and, notwithstanding the bank-

ruptcy of the radiator company, were in a situation to pay, and offered to pay, on deliveries of the ore pursuant to the contract. The ability and offer on the part of the receiver or trustee to perform the contract, which was not such as to oblige the radiator company to perform in person, and to pay the contract price on delivery of the ore, was, in my judgment, sufficient to prevent its abrogation. The receiver in bankruptcy, having taken possession of the assets of the bankrupt and seasonably exercised his option to adopt the contract, and having given notice that he would on delivery of the ore pay therefor, succeeded to all the rights of the bankrupt, and the seller became liable upon the agreement for its failure to deliver the ore. *United States Trust Co. v. Wabash Ry. Co.*, 150 U. S. 287, 14 Sup. Ct. 86, 37 L. Ed. 1085.

The next point is whether the assumption of the contract by the receiver was subsequently affirmed or ratified in its entirety by the trustee. The petitioner contends that the trustee in fact did not assume the contract, and that the assumption by the receiver covered only the right to have shipments of ore made in January. The receiver, on his appointment by the court, wrote the petitioner as follows:

"I hereby notify you that I assume as such receiver all the obligations of the Niagara Radiator Company under the contract, and shall expect you to perform it, hereby agreeing to pay cash on delivery if you so require."

This language is broad enough to constitute an assumption of the contract in its entirety, and is not limited to separate monthly deliveries. Unquestionably the title of the trustee, upon his appointment, related back to the filing of the petition, and the assumption of the contract by the receiver, by and with the consent of the court appointing him, in the absence of any negative intention by the trustee, must be deemed to have been ratified and confirmed by him. Moreover, his assumption of the contract appears clearly enough from the stipulation of facts, which indicates that in March and April, 1907, he in writing demanded the quotas of iron for those months under the contract. That he did not make formal demand for succeeding quotas is not thought important, as the petitioner undoubtedly understood that the contract in its entirety had been assumed by the receiver.

The order of the referee is affirmed, and the claim of the petitioner is allowed at the sum of \$2,299.50.

ST. PAUL FIRE & MARINE INS. CO. v. BIRRELL.

(District Court, D. Oregon. August 6, 1908.)

No. 4,993.

ADMIRALTY—JURISDICTION—MARITIME CONTRACTS.

A contract between a marine insurance company and an insurance broker, by which the latter agreed to procure insurance for the company on marine risks on commission, and to be responsible for all premiums due on such insurance, is not a maritime contract, and an action thereon by the company to recover such premiums is not cognizable in a court of admiralty.

[Ed. Note.—Jurisdiction as to matters of contract, see notes to *The Winslow*, 18 C. C. A. 349; *Bontin v. Rudd*, 27 C. C. A. 530.]

In Admiralty. On exceptions to libel.

Snow & McCamant, for libelant.

A. F. Flegel and Charles H. Carey, for respondent.

WOLVERTON, District Judge. Libelant seeks to recover from respondent an alleged balance for premiums on marine policies of insurance. The case made by the libel is that the parties entered into a contract, whereby, for a certain commission on all premiums, respondent agreed to negotiate insurance in the libelant company upon vessels plying the high seas and the waterways of this state, and personally bound himself to be responsible to libelant for all premiums upon all marine insurance written by it at his instance and request, or for parties introduced by respondent to libelant; that an account should be and was opened between libelant and respondent, and respondent charged with all premiums written under said agreement. Respondent excepts to the libel upon the ground that the cause of action stated is not within the admiralty jurisdiction. It is conceded that, if respondent were the insured, this action would lie, and of this there can be no doubt. A contract of marine insurance is a maritime contract. *Insurance Co. v. Dunham*, 11 Wall. 1, 20 L. Ed. 90. It has been further adjudged that an engagement to pay premiums on marine insurance is a maritime contract. *The Guiding Star* (D. C.) 9 Fed. 521, affirmed in an opinion by Justice Matthews, Id. (C. C.) 18 Fed. 263.

The difficulty with libelant's case here, however, is that respondent did not contract for insurance with libelant, but only to procure insurance to be contracted by others—respondent agreeing to be responsible for the premiums. Such a contract is not maritime. The test of a maritime contract as put by the Supreme Court in *Insurance Co. v. Dunham*, supra, and restated in numerous decisions since, is this: "The true criterion is the nature and subject-matter of the contract, as whether it was a maritime contract, having reference to maritime service or maritime transactions"—jurisdiction being made to depend upon subject-matter, and not upon locality. The contract relied upon by libelant is not a contract of insurance, but is, on the other hand, an independent undertaking on the part of respondent to pay premiums on insurance for which he was not primarily liable. He only became liable, if at all, by virtue of a separate and distinct contract, not even remotely related to service or transactions maritime, and not cognizable in admiralty. Libelant has no better right to sue respondent in admiralty on his personal undertaking alleged than respondent would have to sue libelant there for a balance due on his services for negotiating marine insurance; and, of course, he has no such right. The contract set forth in the libel is in its nature *del credere*, and the dispute involves a balance of accounts between factor and principal. The authorities, both English and American, certainly make of this a *del credere* contract. Such a contract is said by Lord Mansfield, in *Grove v. Dubois*, 1 T. R. 112, 115, to be "an absolute engagement to the principal from the broker, and makes him liable in the first instance." In *Leverick v. Meigs*, 1 Cow. (N. Y.) 645, 663, it is said that the legal effect of a *del credere* agreement is that a factor, for an additional premium beyond the usual commission, when he sells the goods of his

principal, becomes bound to pay the price at all events. Such is the situation of these parties.

Moreover, while the dividing line drawn by the authorities between contracts maritime and not maritime is not always readily perceived, it has been made clear in cases of this nature by several adjudications. Thus in *Marquardt v. French* (D. C.) 53 Fed. 603, 606, we find the following:

"The contract of insurance, indeed, is a maritime contract, and as such is within the jurisdiction of an admiralty court. But a contract or obligation to procure insurance, such as I find this obligation to have been, is not a contract of insurance, nor is it a maritime contract. It is upon the other side of the line dividing contracts which are maritime from those which are not maritime. Such a claim does not differ in principle, so far as the jurisdiction of a court of admiralty is concerned, from a suit to recover compensation for a broker's services in obtaining a charter party; or for building a ship or for soliciting freight."

In *Fox v. Patton* (D. C.) 22 Fed. 746, the libel charged a breach of contract by a ship, and an independent agreement by respondents, its agents in New York, to pay the ensuing damage. Said Brown, District Judge:

"The decision must turn wholly upon the question whether the respondents' contract was or was not a maritime contract. Nothing in the libel warrants the inference that the respondents were under any legal obligation to pay the damages sustained by the breach of the charter party. There is no allegation that the charter party was executed by the respondents, or that they were owners of the bark, or of any part of it. Their only relation to the bark appears to have been that they were her agents in New York. This did not impose upon them any liability for her previous breaches of contract. The only foundation of this action, therefore, is the new and independent promise, on their part, alleged in the libel, to pay the libelants for the previous debt of the ship and of her owners. It does not appear whether or not the debt of the ship and of her owners was discharged, or intended to be discharged, by this new and independent promise of the respondents. If it was not discharged, the libelants' remedy against them remains still available. If the former debt was discharged, then it is a case of novation, in which the only relation of the prior debt to the new obligation is that the former furnishes the consideration of the latter. This original consideration, though in itself a maritime consideration, is not sufficient to make such a new and independent contract a maritime contract."

And in *Minturn v. Maynard*, 17 How. 477, 15 L. Ed. 235, Justice Grier, in a short opinion, disposed of a case somewhat analogous in the following language:

"The libel charges that they are owners of the steamboat *Gold Hunter*, that they had appointed the libelant their general agent or broker; and exhibits a bill, showing a balance of accounts due libelant for money paid, laid out, and expended for the use of respondents in paying for supplies, repairs, and advertising of the steamboat, and numerous other charges, together with commissions on the disbursements, etc. The court below very properly dismissed the libel for want of jurisdiction. There is nothing in the nature of a maritime contract in the case. The libel shows nothing but a demand for a balance of accounts between agent and principal, for which an action of assumpsit, in a common-law court, is the proper remedy. That the money advanced and paid for respondents was, in whole or in part, to pay bills due by a steamboat for repairs or supplies, will not make the transaction maritime, or give the libelant a remedy in admiralty."

See, also, *The Centurion*, Fed. Cas. No. 2,554.

For the foregoing reasons, this court is without jurisdiction in the premises, and the exceptions to the libel should be sustained, and the libel dismissed.

BRADLEY et al. v. HEYWARD et al.

(Circuit Court, D. South Carolina. July 13, 1908.)

1. SPECIFIC PERFORMANCE—CONTRACT—CERTAINTY.

An option provided that on plaintiff's election, after examining defendant's land, defendant would convey all phosphate rock and phosphate deposit contained on or in all of the Middleton lands on Ashley river, described in a specified plat, containing 5,507 acres, for the sum of \$20,000, and also convey a right of way over defendant's other lands to a certain river, together with a site on the river for a washer. *Held*, that such option having subsequently ripened into a contract by the payment of the money, though the right of way and washer site were not located, was not so vague or uncertain as to be incapable of specific performance.

[Ed. Note.—For cases in point, see Cent. Dig. vol. 44, Specific Performance, §§ 71-82.]

2. SAME—MISTAKE.

Defendant executed a written contract to convey to plaintiffs all phosphate rock and phosphate deposit contained on or in all that portion of certain specified land lying between certain boundaries, containing about 5,507 acres, for \$20,000. Several months elapsed between the execution of the option and the payment of the price, during which plaintiffs' employes were engaged in openly prospecting the land, and new deposits were discovered of which defendant must have had knowledge. *Held*, that it was no defense to a suit for specific performance that it was defendant's intention only to sell that portion of the phosphate rock that lay within a tract of about 100 acres, already partially mined.

[Ed. Note.—For cases in point, see Cent. Dig. vol. 44, Specific Performance, § 159.]

3. SAME—UNCONSCIONABLE CONTRACT—INADEQUATE CONSIDERATION.

Defendant, aided by the advice and co-operation of her husband, who was a lawyer, contracted to sell to plaintiffs for \$20,000 all the phosphate rock underlying certain land; the right to mine, however, being subject to certain timber rights which might prevent plaintiffs from mining a large part of the land until 1923. Explorations disclosed that on the land claimed there was about 280,000 tons of phosphate rock lying at an average depth of 8.27 feet, which, at a reasonable royalty of 25 cents per ton would be worth \$70,000. *Held*, that the contract, having been voluntarily made after full opportunity for deliberation by educated persons of more than ordinary intelligence, was not so unconscionable nor based on such a grossly inadequate consideration as to warrant the imputation of fraud and justify denial of specific performance, under the rule that only such inadequacy of price as shocks the conscience and amounts to conclusive and decisive evidence of fraud will justify the denial of such relief.

[Ed. Note.—For cases in point, see Cent. Dig. vol. 44, Specific Performance, §§ 141-151.]

4. SAME—HARDSHIP.

The court in its discretion would not be authorized to deny specific performance because performance of the contract, independent of fraud, would result in hardship to defendant; there being no circumstance other than alleged inadequacy of consideration constituting such hardship.

[Ed. Note.—For cases in point, see Cent. Dig. vol. 44, Specific Performance, §§ 141-151.]

In Equity.

Von Kolnitz & Waring, for complainants.

Julius H. Heyward, Joseph W. Barnwell, and Nathaniel B. Barnwell, for defendants.

BRAWLEY, District Judge. This is a bill for specific performance of a contract for the sale of phosphate rock and phosphate deposit on the Middleton lands on Ashley river.

The plaintiffs, citizens of Massachusetts, are the owners of a large body of phosphate land in this state lying near the Middleton place. Being desirous of extending their holdings, they employed George F. Von Kolnitz, Esq., a lawyer of Charleston, in the spring of 1905, to obtain options on other lands, and it appears from the testimony that he succeeded in obtaining about 30 options. With that purpose he made a visit to Greenville in April and had an interview with Julius H. Heyward, Esq., the husband of the defendant, and commenced negotiations with him. Mr. Heyward informed him that nothing could be done without consultation with his wife, then on the Middleton place, and, Mr. Von Kolnitz offering to pay his expenses, Mr. Heyward came down, and, after conference with the defendant, agreed with the plaintiffs' attorney upon the terms, and prepared the agreement which gives rise to this controversy, Mr. Von Kolnitz adding the stipulation as to right of way, and the agreement was executed April 20, 1905. The agreement provides:

"(1) That the said Elizabeth M. Heyward, for and in consideration of the sum of \$5.00 to her in hand paid, hereby grants and conveys to the said George F. Von Kolnitz, Jr., attorney, for the period of four months from this date, the right and option to purchase all phosphate rock and phosphate deposit contained on or in all that portion of the Middleton lands on Ashley river," etc., containing about 5,507 acres more or less.

"(2) That the said George F. Von Kolnitz, Jr., attorney, hereby agrees to pay for said phosphate rock and phosphate deposits (if after examination of said land he shall elect to purchase the same) the sum of \$20,000, payable in cash on the 20th day of August, A. D. 1905, on which date this option shall expire.

"(3) That the said George F. Von Kolnitz, Jr., attorney, his agents and employes, are hereby granted all necessary rights of access to and entry upon said land during the above-limited period for the purpose of examining the same by soundings, excavations, etc., and all necessary conveyances are in due course to be executed and delivered for the purpose of completing said sale and transfer, which conveyances shall also include the right to a right of way to the Ashley river over the other lands of said Elizabeth M. Heyward, and a site upon said river for a washer, provided, however, that neither said right of way nor site shall in any way interfere with the rights granted heretofore to the United Timber Company, as shown by a lease now on record in the office of the registry of mesne conveyance, Dorchester county."

In August, 1905, Mrs. Heyward addressed a letter to George F. Von Kolnitz, attorney, saying:

"The limit of the option heretofore granted you by me for the purchase of the phosphates on the Middleton lands and rights set forth therein is hereby extended to September 1, 1905."

On the 30th of August Mr. Von Kolnitz paid to the defendant the sum of \$20,000, and shortly thereafter prepared a deed conveying to

plaintiffs all the phosphate rock and phosphatic deposits contained in the land described, and providing a right to construct and operate tramways or railways over and upon the lands for the mining or removal of the rock, and the right to occupy a site on the Ashley river for a washer, which Mr. Heyward, who throughout all the negotiations had represented the defendant, with her written authority, objected to, and, after some fruitless negotiations and correspondence, the defendant referred Mr. Von Kolnitz to her attorney, H. A. M. Smith, Esq., who, after some negotiations, prepared an instrument in writing to carry into effect the agreement of April 20, 1905, which was acceptable to Mr. Von Kolnitz, but which Mrs. Heyward refused to execute. Being unable to reach any agreement, this bill has been filed.

In the answer and in the argument numerous grounds are set up why the agreement should not be specifically enforced. The first is, as set forth in the answer, that the terms are "too vague and uncertain to be capable of reasonable construction and enforcement, inasmuch as no place is fixed for the site of the washer therein referred to, and no limits or boundaries are fixed for the right of way mentioned in said option, nor is the compensation fixed for the use of either."

It appears from the testimony that all the negotiations between the parties were conducted between Mr. Von Kolnitz, on the one side, and Mr. Heyward, on the other. Both of them are lawyers of mature age and considerable experience. The agreement was prepared by Mr. Heyward. It involves a considerable sum of money, and was prepared after full deliberation, and it is fair to assume that when he prepared a paper of this character he intended, if the other party performed its obligation, to give an enforceable contract, and not a mere option on a lawsuit, wherein the measure of damage for breach of contract would be so uncertain as to have no calculable value. I cannot agree to the contention that the terms of this contract are "too vague and uncertain to be capable of reasonable construction and enforcement." The main features of the agreement are perfectly clear, and that is that the plaintiff, if after examination of the land he shall elect to do so, shall have the right to purchase all phosphate rock and phosphate deposit contained on or in all of the Middleton lands on Ashley river described in the plat of Simons & Mayrant, containing about 5,507 acres. It is further stipulated that all necessary conveyances are in due course to be executed and delivered for the purpose of completing said sale and transfer. It is true that the location and dimensions of the right of way are not specifically designated, but it seems to me that the maxim "*Id certum est quod certum reddi potest*" applies. The testimony is that a right of way for the removal by rail or tram of phosphate rock when mined, and a washer for the purpose of cleaning it, are necessary for the reasonable use of the thing agreed to be sold, and the agreement stipulates specifically for such right of way and a site for a washer. In the nature of the case, the precise location of this right of way and washer could not be determined in advance, because it was uncertain where the phosphate rock would be found. In the timber lease referred to there was provision for a right of way not exceeding 66 feet in width, and the location was fixed because the site

of the timber was known. In this case it seems to me that there will be little practical difficulty in defining such location of right of way and site for washer as would be consistent with the proper use and enjoyment of the main thing granted—that is, the removal of the phosphate rock in the land—and, of course, with due regard to the rights of Mrs. Heyward.

The next ground stated as reason for nonperformance is that of mistake. Mr. Heyward testifies that when Mr. Von Kolnitz approached him on the subject he informed him that he knew that there was a body of phosphate deposit upon a certain tract of the Middleton land, but it was a low-grade rock and had been worked over by several parties, and that in drawing the agreement he had in mind this tract only. The testimony is that during the lifetime of the father of the defendant several parties successively had mined phosphate on this land, one after the other abandoning operations, and that it was supposed that the phosphate had been exhausted, and each succeeding party finding new deposits, but for a number of years there had been no mining upon the lands. Mr. Heyward's home is in Greenville; but his wife, the defendant, usually spends the winter and spring at the Middleton place, and Mr. Heyward is frequently there. There is no room to doubt that neither Mr. Heyward nor Mr. Von Kolnitz, when the agreement of April 20, 1905, was entered into, had any knowledge of the extent of the phosphate deposit upon these lands; nor is there any ground to believe from the testimony that the plaintiffs had any actual knowledge, although from their experience and the nature of their business they would presumably be more capable of forming a correct opinion on this subject than Mr. Heyward would be. The nature of this phosphatic deposit in the low country of South Carolina is peculiar, and has given rise to much curious speculation. It is found sometimes in pockets, and sometimes in strata, of greater or less thickness, lying at greater or less depth, in certain territory, but does not appear to be a continuous strata.

A plat was exhibited at the hearing, prepared by Simons & Mayrant from data furnished by M. E. Hertz, under whose directions the investigation was made, from which it appears that: Upon the whole tract of over 5,500 acres rock was found at 982 stations on about 560 acres; 71 pits were opened, and the rock was found at an average depth of a little over 8 feet, the average thickness of the strata being about 8½ inches. The claim now made that it was the intention of the defendant to sell only that portion of the phosphate rock lying within a tract of about 100 acres, which had already been partially mined, is utterly inconsistent with the agreement whereby is given in plain words the right to purchase "all phosphate rock and phosphate deposit contained on or in all that portion of the Middleton lands on Ashley river," lying between certain boundaries, containing about 5,507 acres, and whatever may have been the defendant's knowledge or lack of knowledge of the extent of the phosphatic deposit in April, certainly by the end of August, when she accepted the payment of \$20,000, she must have known that other deposits had been discovered, for a large number of men employed by plaintiffs had been engaged for months, with

her permission, in making soundings over the whole tract. It was the kind of work that could not be done secretly. Those who had eyes to see could see what was going on, and it appears from the testimony and from the correspondence of Mr. Heyward that he had other offers during the summer of 1905, for he was somewhat urgent that the matter be closed, expressing the belief that he could make more advantageous terms with other parties if plaintiffs declined to take, and in one of his letters he says:

"I am confident there is a quantity of rock on the land."

Neither at the time the money was paid, nor at any other time prior to the commencement of this suit, so far as appears from the record, was there any contention that there had been any mistake.

The Master of the Rolls, in *Swaishland v. Dearsley*, 29 *Beavan*, 433, says:

"The principle upon which this court proceeds in cases of mistake is this: If it appears upon the evidence that there was in the description of the property a matter about which a person might bona fide make a mistake, and he swears positively that he did make such mistake, and his evidence is not disproved, this court cannot enforce the specific performance against him. If there appear on the particulars no ground for the mistake, if no man with his senses about him could have misapprehended the character of the parcels, then I do not think it is sufficient for the purchaser to swear that he made a mistake or that he did not understand what he was about."

This case was cited in *Tamplin v. James*, 15 L. R. Chancery Division, by *Baggalay, L. J.*, who says:

"I think that the law is correctly stated by Lord Romilly in *Swaishland v. Dearsley*."

And after referring to the facts in that case, he says:

"But where there has been no misrepresentation, and where there is no ambiguity in the terms of the contract, the defendant cannot be allowed to evade the performance of it by the simple statement that he has made a mistake. Were such to be the law, the performance of contracts could rarely be enforced upon an unwilling party who is also unscrupulous. * * * I think that he is not entitled to say to any effectual purpose that he was under a mistake when he did not think it worth while to read the particulars and look at the plans. If that were to be allowed, a person might always escape from completing the contract by swearing that he was mistaken as to what he bought, and great temptations to perjury would be offered. Here the description of the property is accurate and free from ambiguity."

Fry, on Specific Performance, says (section 765):

"It seems on general principles clear that one party to a contract can never defend himself against it by setting up a misunderstanding on his part as to the real meaning and effect of the contract or any of the terms in which it is expressed."

I think there is no merit in this contention, and this brings me to the consideration of the other grounds set up as a defense and as reasons for a rescission of the contract, which the answer prays. They are that the contract is an unconscionable one, that the consideration paid is grossly inadequate, and that the enforcement of it by the court would result in injustice and hardship to the defendant.

The parties to the contract have already been named; both parties being represented by competent lawyers. It is not therefore a case of the wolf and the lamb. The fairness of it must be judged of as of the time at which it was entered into. The defendant was the owner of a large body of land upon which it was known that there was a phosphate deposit, but the extent of that deposit was not known. There is nothing in the testimony which shows that the defendant was at that time under any stress of necessity which would impel her to sacrifice her property, and there is no testimony tending to show misrepresentation or concealment on the part of the plaintiffs. The extent of the phosphate deposits could only be ascertained after thorough examination, which required time, skill, and the expenditure of a considerable amount of money. The plaintiffs were willing to make this expenditure if, after their examination, they could purchase upon terms which would be profitable to them. The defendant, after time for full deliberation, fixed those terms. Up to this point it seems clear that the contract was made fairly, without fraud or overreaching or taking any undue advantage. It was not made in haste, but after full opportunity for deliberation, by educated men, of more than ordinary intelligence, having the use of their eyes, their minds on the alert, and their interest awakened, and means of knowledge being open to both. It was known to both parties that there was rock on the land. The plaintiffs were willing to expend the time and money necessary to develop the extent of the deposit, and the defendant was willing to allow them to do so, limiting the time for such examination, and agreeing to sell all the rock upon the land for a fixed sum. All the expense of this exploitation was to be borne by the plaintiffs. This expense, according to the testimony, was something over \$2,500, and would have been a total loss to the plaintiffs if rock in paying quantities had not been found. There is nothing unreasonable or unconscionable in such a contract. In the very nature of things all mining operations are problematical and doubtful. No science can afford a sure guaranty against losses, disappointments, and reverses, and it comes to this: Shall the plaintiffs be deprived of the benefits of a contract, fair and unobjectionable at the time it was made, because it has turned out that, as the result of their enterprise and expenditure, a much larger quantity of rock has been discovered on the land than the defendant believed to be there at the time the contract was made?

Haywood v. Cope, 25 *Beavan*, 140, was a case for specific performance of a mining contract, where the mines turned out to be worthless. It appears in that case that the plaintiff had, 20 years before, worked the coal under his estate, but abandoned it as unprofitable. There were two pits on the ground, and before entering into the agreement with the plaintiff the defendant applied for leave to have one of them cleared and to examine the coal in the shaft. He went down and examined the coal, and afterwards the agreement was entered into, and the defendant went into possession. It was soon discovered that the coal was "absolutely not worth getting." Upon a bill for specific performance the defendant resisted, on the ground of the uncertainty of the contract, misrepresentation, and concealment of the plaintiff, and the hardship of being obliged to pay £100 a year during the remainder

of the lease, without receiving any benefit whatever from the mines. Although he had examined the mines before purchasing, he said that he had no knowledge of mines, and that he was wholly ignorant of these matters. The Master of the Rolls says:

"The real fact is that the speculation has turned out to be extremely bad, and this is shown by the evidence. The seams dwindled down from 3 feet to 20 inches; but if, instead of diminishing, it had increased to that extent, the court would probably have heard nothing about it. Then it is said that this is an extremely hard case, that in point of fact the plaintiff is insisting upon the defendant paying him £1,400 for a thing that has turned out to be literally worth nothing, and that according to the discretion that the court exercises in such cases it cannot compel specific performance of the contract. Upon this subject, which is one upon which I have before made several observations, I will refer again to a passage which I have always considered binding upon me, for it is most important that the profession and those who have to advise in reference to this subject should understand the rule which is adopted in this and the other courts, which is: That the discretion of the court must be exercised according to fixed and settled rules. You cannot exercise a discretion by merely considering what as between the parties would be fair to be done. What one person may consider fair another person may consider very unfair. You must have some settled rule and principle upon which to determine how that discretion is to be exercised."

Lord Eldon observes, in the case of *White v. Daman*:

"I agree with Lord Rosslyn that giving specific performance is matter of discretion, but that it is not an arbitrary, capricious discretion. It must be regulated upon grounds that will make it judicial. I also refer, as I have upon former occasions, to a passage from the celebrated argument of the Master of the Rolls in *Burgess v. Wheate*, where at the conclusion he cites a well-known passage from Sir Joseph Jekyll upon the subject of discretion of the court, and gives his own opinion. He says: 'And though proceedings in equity are said to be *secundum discretionem boni viri*, yet when it is asked *vir bonus est quis*, the answer is *qui consulta patrum qui legis jura que servat*.' And, it is said in *Rooke's Case*, discretion is a science not to act arbitrarily, according to men's wills and affections, so the discretion which is to be exercised here is to be governed by the rules of law and equity, which are not opposed, but each in its terms to be subservient to the other. This discretion, in some cases, follows the law implicitly; in others, assists it and advances the remedy; in others again, it relieves against the abuse or allays the rigor of it—but in no case does it contradict or overturn the grounds or principles thereof, as have been sometimes ignorantly imputed to this court. That is a discretionary power which neither this nor any other court, not even the highest, acting in a judicial capacity, is by the Constitution intrusted with. This description is full and judicious, and it ought to be imprinted upon the mind of every judge. If therefore, in a case of this description, I were to say that, according to my discretion, I ought to leave these persons to their action at law, upon what principle or ground could I do it, except that in a matter of speculation it has turned out very favorably to one party and very unfavorably to the other? It is obvious that in a case of a sale at auction, if the property is sold for an extremely inadequate value, it is impossible for the person to repudiate the contract. The mere principle of what might have been fair or what might have been the right thing to do between the parties, had all the elements of value been known which have since transpired, cannot be ground for exercising or regulating the discretion of the court, if all the facts which were then in existence were known to both parties. I can understand that the court will exercise the discretion and will not enforce the specific performance of a contract where to a degree the performance of the contract would be to compel a person who has entered inadvertently into it to commit a breach of duty, such as where trustees have entered into a contract the performance of which would be a breach of trust. Those are cases where by fixed and settled rule the court is enabled to exercise its dis-

cretion, but the mere inadequacy or excess of value is not in my opinion a ground for exercising any such discretion as that which is suggested in this case. That this is a very hard case there is no doubt and it may be extremely proper that the plaintiff make an abatement in respect of it; but that is a totally different matter, one which is in the forum of his own conscience, but not one which I can notice judicially. In my opinion this is a contract which was fairly entered into between the parties. There is nothing to invalidate it, and the usual decree must therefore be made for the specific performance of the contract, with costs to the present time."

Fry, on Specific Performance, says (section 389):

"The fairness of a contract, like all its other qualities, must be judged of at the time it is entered into, or at least when the contract becomes absolute, and not by subsequent events for the fact that events uncertain at the time of the contract and afterwards were in a manner contrary to the expectation of one or both of the parties is no reason for holding the contract to have been unfair. The period, says the Irish Lord Chancellor Manners, at which the court is to examine the agreement between the parties, is the time when they contracted."

The contention of the defendant which finds most support in the text-writers and in the decided cases is that a court of equity will refuse to lend its aid to the enforcement of a contract where the price paid is grossly inadequate to the real value. There is no fixed standard by which to determine this question of inadequacy which devolves upon the equity court the duty of revising men's bargains and substitutes the chancellor's opinion for that of the contracting parties as to the price which ought to be paid. Lord Chief Baron Eyre says, in *Griffith v. Spratley*, 1 Cox Ch. Cas. 388:

"The value of a thing is what it will produce and admits of no precise standard. It must be in its nature, fluctuating, and will depend upon 10,000 different circumstances. One man in the disposal of his property may sell it for less than another would. He may sell it under a pressure of circumstances which may induce him to sell it at a particular time. Now, if courts of equity are to unravel all these transactions, they would throw everything into confusion and set afloat all the contracts of mankind."

Lord Eldon says, in *Coles v. Trecothick*, 9 Vesey, 246:

"But, further, unless the inadequacy of price is such as shocks the conscience, and amounts in itself to conclusive and decisive evidence of fraud in the transaction, it is not itself a sufficient ground for refusing a specific performance."

Fry, on Specific Performance, says (section 44):

"There is an observation often made with regard to the jurisdiction in specific performance which remains to be noticed. It is said to be in the discretion of the court. The meaning of this proposition is not that the court may arbitrarily or capriciously perform one contract and refuse to perform another, but that the court has regard to the conduct of the plaintiff and to circumstances outside of the contract itself, and that the mere fact of the existence of a valid contract is not conclusive in the plaintiff's favour."

And in section 46:

"But of the circumstances calling for the exercise of this discretion the court judges by settled and fixed rules. Hence the discretion is said to be not arbitrary or capricious, but judicial. Hence, also, if the contract has been entered into by a competent party and is unobjectionable in its nature and circumstances, specific performance is as much a matter of course and therefore

of right as are damages. The mere hardship of the results may not affect the discretion of the court."

Before considering the testimony on the subject of inadequacy, I will proceed to examine those cases cited and relied on by the defendant as establishing the principle upon which it is claimed that she is entitled to be relieved of the performance of this contract. In considering these cases, it is well to bear in mind what was said by the great Chief Justice, in *Cohens v. Virginia*, 6 Wheat. 398, 5 L. Ed. 257:

"It is a maxim not to be disregarded that general expressions in every opinion are to be taken in connection with the case in which those expressions are used."

The first case cited, and one which seems to be most relied on, is *Seymour v. Delancey*, 6 Johns. Ch. (N. Y.) 222. In that case Ellison, the ancestor of the defendant, was to convey two farms containing 763 acres of land, in exchange for one equal undivided one-third part of two lots of land in the village of Newberg. The chancellor, after reviewing the testimony, fixed the one-third of the Newberg lots at \$6,000, and the farms at \$12,000. He also found that Ellison "was in the last year or two of his life rendered for a considerable part of his time unfit for business by habitual intoxication; his mind must have felt the pernicious effects of that habit, and have lost its original strength when he made the bargain in question. The proof is abundantly sufficient to render the fact of his competency to contract with the requisite judgment doubtful." The contract was made in January, and he died in August, and the chancellor says:

"This fact adds greatly to the force of the considerations growing out of the inadequacy of the price, and is clearly sufficient within the view of all the cases to render it highly discreet and just to refuse the aid of the court to the specific performance of so hard and so extravagant a bargain, gained from a habitual drunkard in the last year of his life and just before his infirmities had begun to incapacitate him entirely for business. There is another circumstance in the case which ought to be taken into consideration, when the plaintiff comes here seeking a specific performance: He was not in a condition to give a good title to the village lots, either when he contracted or when the deeds were to be executed, or at the time of the death of Ellison."

The decree of the chancellor, refusing specific performance, was reversed on appeal by the Court of Errors. *Seymour v. Delancy*, 3 Cow. (N. Y.) 445, 15 Am. Dec. 270. But the doctrine that "inadequacy of price may of itself and without fraud or other ingredient be sufficient to stay the application of the power of this court to enforce specific performance of a private contract to sell land" has the sanction of the great name of Chancellor Kent.

The next case cited is one from our own state (*Clitherall v. Ogilvie*, 1 Desaus. 250), where the court refused to decree specific performance of a contract for the sale of land, where the inadequacy was very great. In its opinion the court refers to:

"The reluctance of the defendant (a young man but just of age, ignorant of the land and its value) to determine the matter hastily, his wishing to consult with a friend whom he thought well acquainted with the land, showed plainly that he was not desirous of selling immediately and that he was not sufficiently competent to determine on the value. All these circumstances show that, though no fraud or imposition on complainant's part, yet there was

such an eagerness, such an anxiety in him to conclude the bargain, such an astuteness of conduct as do not give it all the marks of fairness, justice, and equality. * * * That the consideration is enormously inadequate here I need only refer to the testimony of Capt. Pinckney, from whence it appears that the land at the lowest valuation must be worth four times as much as was agreed to be given for it."

In a note to that case by Chancellor Desaussure, he says:

"The rule seems to be that mere inadequacy of price in a contract deliberately made between two persons consant of their rights and competent to manage their own affairs should not be a ground purely of itself to vitiate the contract; but the decided cases express a qualification which in reality is a material violation of the rule itself, for it is added that the inadequacy of price shall not vitiate the contract unless it be so gross that every good man would at once exclaim against it, and as would furnish violent presumptive evidence of fraud, imposition, or oppression in the buyer, or manifest ignorance or deep necessity in the seller."

The next case is *Butler v. Haskell*, 4 Desaus. 651, where the defendants agreed to sell for \$1,200 for each share their interest in the estate of an idiot, and the bill was to set aside these sales; the proof being that each share was worth from \$13,000 to \$14,000, and that the Butlers were uneducated and ignorant men, in necessitous circumstances, who had employed the defendant as agent to establish their claims to the property, and he being a man of ability, astuteness, and experience. In its opinion the court says:

"It has been left, perhaps wisely, to the experience of the courts of justice to apply the mere principles of equity to each case according to its particular circumstances, and thus gradually to form a practical system of pure justice, and the courts have never decided as a broad principle that mere inadequacy of price, unconnected with direct fraud or imposition or concealment, or advantage taken of extreme weakness or great necessity, should be a distinct and independent ground of vitiating contracts; but the courts have said that the inadequacy may be so gross as to furnish strong and even conclusive presumption of fraud, and in this way the grossness of the inadequacy may avoid the sale."

The next case is *Gasque v. Small*, 2 Strob. Eq. 72. In that case the court refused to enforce specific performance, and in its opinion says:

"In this case the defendant was a young man, who had arrived at the age of 21 years a few weeks before the agreement, and who from the want of sagacity, advice, and experience was unable to cope with the other party in the contract. It is manifest that his examination of the land was utterly insufficient to enable him to ascertain its value, which from the glowing descriptions of the advantage that he might derive from the purchase was, no doubt, greatly exaggerated in his imagination, and although the case does not come within the class of contracts of young heirs who are entitled to expectations, yet it approximates the principle in practice. The weight of evidence establishes such inadequacy of value that the most liberal calculation cannot resist the conclusion that Kirton (who, although apparently only the agent of Gasque, is the real party in interest) bargained the land to the defendant for double its value, and probably for three or four times as much as it would bring if sold at public auction."

Church of the Advent v. Farrow, 7 Rich. Eq. 378, was a case where one Henry agreed to give to the church a lot for the site of an Episcopal Church and for a burying ground, to contain one acre. Henry

went to the spot and pointed out the lot, but no deed was executed. After his death, his daughter objected to the use of the lot as a burial ground, and refused to sign a deed in the form demanded. The vestry brought suit for specific performance. Chancellor Johnstone, who heard the case on circuit, said:

"I do not think there is sufficient evidence, even if parol proof were admissible, to establish an agreement which this court will enforce."

Chancellor Wardlaw, speaking for the Court of Appeals, affirming the decision below, says:

"Besides, if the plaintiff had proved sufficiently an agreement, the suit is an application to the extraordinary jurisdiction of the court, where discretion is tolerated, and absolute right cannot be claimed. With every disposition to limit discretion, we should hardly be disposed to afford relief to plaintiff when the enforcement of defendant's contract (essentially voluntary), although supported by the consideration of co-subscription, will be attended with inequitable loss to defendants in impairing the value of adjoining lots."

These are all of the South Carolina cases cited by the defendant. The cases in the Supreme Court of the United States are: First, *King v. Hamilton*, 4 Pet. 328, 7 L. Ed. 869. In its opinion in that case the court says (page 329 of 4 Pet. [7 L. Ed. 869]):

"The complainants, after the lapse of 20 years seek for the specific execution of a contract which has not been performed on their part, and the execution of which will be manifestly unjust and inequitable."

The facts in that case have no possible analogy to those in the case under consideration, and it would be unprofitable to cite them in detail.

Nickerson v. Nickerson, 127 U. S. 668, 8 Sup. Ct. 1355, 32 L. Ed. 314, was, as stated in the opinion of the court on page 677 of 127 U. S., page 1359 of 8 Sup. Ct. (32 L. Ed. 314):

—"the case of a husband who prior to marriage induced in the mind of his intended wife expectations in reference to real property, which, after marriage, he failed to meet, but in respect of that property he did not enter—and perhaps intentionally refrained from entering—into any distinct and binding agreement. * * * She relied upon his honour and has been deceived, but those facts, however strongly they appeal to our sympathy, cannot justify the court in finding upon the meager evidence in this case that there was an agreement upon his part, in consideration of marriage, to settle upon her either the property in Portland, or the property purchased with the proceeds of the sale."

McCabe v. Matthews, 155 U. S. 550, 15 Sup. Ct. 190, 39 L. Ed. 253, was a case where Mrs. Montgomery entered into a written contract with Matthews for the conveyance of a tract of land containing 1,635 acres. The contract recited the consideration of \$1, and the further consideration of a tract of five acres to be planted out in orange trees, etc. The opinion of the court, on page 555, 155 U. S. and page 192 of 15 Sup. Ct. (39 L. Ed. 253), sufficiently discloses the nature of the case, where Justice Brewer says:

"So that we have presented the case of one who, investing \$1 in the proposed purchase of land and doing nothing to assist his vendor in furnishing the property or performing the work necessary to be furnished and performed by such vendor to acquire the title to the land, waits nine years after his contract has been entered into, nearly nine years after he has good reason to believe that such vendor repudiates all liability under the contract, nearly five years after notice has been given by such vendor of his acquisition of the title

by filing the deeds in the public records, two years after he receives actual notice of that fact, and then, without the tender of any money or other consideration, appeals to a court of equity to compel such vendor to deed to him an interest in land worth at the time of his contract only \$150, and now \$7,500. It seems to us to be a case of a purely speculative contract on the part of the plaintiff. Doing nothing himself, he waits many years to see what the outcome of the purchase by the defendant shall be. If such purchase proves a profitable investment, he will demand his share; if unprofitable, he will let it alone. Under those circumstances, the long delay is such laches as forbids a court of equity to interfere."

Willard v. Tayloe, 8 Wall. 557, 19 L. Ed. 501, was a bill for the specific performance of a contract for the sale of certain real property in the city of Washington, made in 1854, in the form of a lease for 10 years, giving the right or option to purchase, which was in the nature of a continuing offer to sell. The contract was not completed by the acceptance of the defendant's proposition to buy, until April, 1864, after the passage of the act of Congress making notes of the United States a legal tender, and one of the chief questions in the case was whether or not the complainant should pay the stipulated amount in gold and silver coin; the legal tender notes at the time when tendered being worth only a little more than one-half of the stipulated price. The court decided that the substitution of notes for coin could not have been in the possible expectations of the parties at the time the contract was made, and ordered the conveyance of the premises upon the payment in gold and silver coin. In considering the question whether there should be an enforcement of the contract, owing to the fact that the property had greatly increased in value, the court says:

"It is true that the property has greatly increased in value since April, 1854. Some increase was anticipated by the parties, for the covenant exacts, in the case of the lessee's election to purchase, the payment of one-half more than its then estimated value. If the actual increase has exceeded the estimate then made, that circumstance furnishes no ground for interference with the arrangements of the parties. The question in such cases always is: Was the contract at the time it was made a reasonable and fair one? If such were the fact, the parties are considered as having taken upon themselves the risk of subsequent fluctuations in the value of the property, and such fluctuations are not allowed to prevent its specific enforcement."

I have now reviewed all the cases in South Carolina and in the Supreme Court of the United States cited by the learned counsel for the defendant, and it seems to me clear that mere inadequacy of price upon a contract deliberately made between two persons consulant of their rights and competent to manage their own affairs does not of itself furnish ground to vitiate the contract; but the counsel insists that gross inadequacy is equivalent to fraud, and cites *Byers v. Surget*, 19 How. 303, 15 L. Ed. 670, quoting as follows:

"To meet the objection made to the sale in this case founded on the inadequacy of the price at which the land was sold, it is insisted that inadequacy of consideration, singly, cannot amount to proof of fraud. This decision, however, is scarcely reconcilable with the qualification annexed to it by the courts, namely, unless such inadequacy be so gross as to shock the conscience, for this qualification implies necessarily the affirmation that, if the inadequacy be of a nature so gross as to shock the conscience, it will amount to proof of fraud."

The facts in that case are a good illustration of the class of cases calculated to shock the conscience. *Byers* was a member of the firm

of W. B. Duncan & Co., which in the year 1835 bought various tracts of land in the state of Arkansas. In 1836, upon the dissolution of the firm, these lands were conveyed to Byers. In 1840, four years after the dissolution of the firm of William B. Duncan & Co., an action was instituted in the name of that firm by William B. Duncan against one Noadiah Marsh for a breach of covenant, and in that suit, under the plea of his subsequent discharge in bankruptcy, the court gave judgment in favor of the defendant, with costs of suit. This suit against Marsh was commenced and prosecuted long after the dissolution of the partnership, and, it was claimed, without their authority; all of them residing beyond the limits of the state of Arkansas. Surget, who had been Marsh's attorney in the inferior court, assumed to himself the power to tax the costs adjudged to the defendant, prepared a description of the property which he chose to have seized in satisfaction of that process, and ordered the sheriff to levy upon the whole of what he had so described, and under an execution for \$39.10 peremptorily ordered the sale of more than 14,000 acres of land, belonging to Byers, estimated by witnesses to be worth from \$40,000 to \$70,000, and as the court says:

"And, finally, under a proceeding irregular in its origin, commenced by himself and by him controlled to its consummation, of becoming the purchaser of the property estimated as above, for the sum of \$9.13½, and refused after the sale and purchase to accept in redemption of the lands so sacrificed a sum of money tendered to him much more than equal to all the costs or all the expenses incident to the judgment."

In reviewing the facts, the court says:

"They betray that *malus dolus* in which the design of the appellant was conceived, which appears to have presided over and regulated the progress of the design from its birth to its consummation, to which design the appellant has tenaciously clung, in the seeming expectation that it was beyond the corrective powers of law or justice."

The rule as stated by Fry is as follows:

"Sec. 442. With regard to it as a ground for the setting aside of transactions, the doctrine of the court is that inadequacy of consideration, if only amounting to hardship, even great hardship, is no ground for relieving a man of a contract which he has wittingly and willingly entered into, but that it may be so enormously great as to be a conclusive evidence of fraud, and that it is then a ground for setting aside a transaction affected by it.

"Sec. 443. Regarded as a ground of defense to a specific performance, the judgment of the older cases was that inadequacy of consideration was a sufficient ground; it being regarded, even where not amounting to evidence of fraud, as a circumstance of hardship which would stay the interposition of the court.

"Sec. 444. But it appears to have been established by the decisions of Lord Eldon and Grant, M. R., that mere inadequacy of consideration is no defense to specific performance unless it amount to an evidence of fraud, and so would furnish ground even for canceling the contract."

There follows the citation from *Coles v. Trecothick*, which has been already referred to.

It will be necessary now to refer to the testimony to see whether there is such inadequacy of price here as, in the words of Lord Eldon, "shocks the conscience and amounts in itself to conclusive and decisive evidence of fraud in the transaction." Mr. Hertz, who had charge of

the operations for the examination of this property, testifies that he had a plat prepared by Simons & Mayrant from the field notes, and this plat was sent on to the plaintiffs for their information. As this plat was prepared long before this litigation arose, and bears intrinsic evidence of considerable care in its preparation, there would seem to be grounds for accepting it as fairly representing the area of rock which the plaintiffs supposed to exist at the time when the contract was consummated by the payment of the purchase money. From this plat it appears that rock was found on 560.2 acres, at an average depth of 8.27 feet, and average thickness of 8.7 inches. In this area was included 126 acres which had already been mined by successive operators, but it appears from the testimony that some rock was still left in this mined area. How much is not definitely stated. The defendant, since the beginning of the hearings in this case, has had a survey made by Mr. Emerson and others, and their testimony is that there are 718.67 acres of phosphate lands, and plats prepared by Mr. Emerson were offered in evidence. These plats were criticised by witnesses for the plaintiffs, as containing no course and distances and no base lines; but it does not seem to be necessary for me to decide as to the relative accuracy of these surveys, inasmuch as Mr. Hertz, claiming to speak with authority as agent for the Bradleys, testified at the last hearing that the plaintiffs were willing to accept the plat prepared by Simons & Mayrant, and give to the defendant all outside of it, that the plaintiffs did not want anything except what that plat called for, and the counsel for plaintiffs indorsed and reiterated this statement in his argument, so the plaintiffs' rights will be limited to the area described in the plat prepared by Simons & Mayrant; that is to say, to the 560.2 acres. The preponderance of the testimony is that there is about 500 tons of phosphate rock to the acre, and, if we assume that there is the same average upon the 126 acres already mined, there would be about 280,000 tons of phosphate rock upon the land, lying at an average depth of about 8.27 feet. A good deal of testimony has been offered as to the value of phosphate rock. The price of rock is fluctuating, and it is difficult to say what is a fair market price. Since the beginning of the hearings in this case there has been a drop in the price, owing, it is said, in part at least, to the discovery of new phosphate deposits in Florida, and it appears that the greater part of the phosphate territory in this state is under the control of two companies, the plaintiffs being one, and the Virginia-Carolina Chemical Company another, and, as they are large manufacturers of fertilizers, most of the product appears to be consumed by these two companies. The testimony as to the royalty—that is to say, the price paid to the owners of lands for rock after it is mined—seems also to vary. At the Bolton mines 15 cents a ton is paid. Mr. Pinckney testifies that on the lands mined by him a royalty of 25 cents and 30 cents a ton is paid, with provision for an increase of royalty when the rock sells at a certain price, on a sliding scale. In the "flush times" of the phosphate business as much as \$1 a ton was paid. No direct testimony has been offered as to the value of the rock upon this land as it lies, except that of Mr. Pinckney, who gives it as his opinion that it is worth 25 cents a ton. If it is

worth 25 cents a ton, and there are 280,000 tons, of course it follows that this deposit upon the Middleton lands would be worth \$70,000. By the agreement between the parties the right to mine and remove this rock is subject to a timber lease, dated September 17, 1903, which gives to the lessees 15 years from date to remove the timber, with the right to five years' additional time upon certain conditions. As the value of growing timber, such as covers part of this land, is likely to increase from year to year, the probabilities are that the lessees will not remove the timber until near the time of the expiration of their lease, and the right to remove the phosphate, being subject to that lease, there is a possibility, a fair probability, in fact, that the owners of the phosphate rock may not have the right to remove it for many years to come. It is true that, according to the testimony, a good deal of this land is not covered by timber; but as a great deal of the rock lies at a depth which will require expensive machinery in its excavation, and a provision for railways and washers, it would seem likely, as a business proposition, that the owners would not provide the plant necessary until the time was near at hand when their operations would not be incumbered by the timber lease, which, as already stated, does not expire until September 17, 1923. If that is so, and the plaintiffs should not come into the enjoyment of their purchase until 15 years after the payment of the purchase money, August 30, 1905, the sum of \$20,000 already paid would at the legal rate of interest in this state be about doubled.

It is impossible for me to say with any certainty what the value of this phosphate deposit will be 10 or 15 or 20 years hence. Its value consists in the presence of bone phosphate of lime, which, treated with sulphuric acid, is converted into a commercial fertilizer. For 15 or 20 years the mining of phosphate rock in this state was considered a very profitable industry. This industry was seriously affected by the discovery of phosphate deposits in the state of Florida, and the testimony is that the Florida phosphates were of much higher grade than those in this state, and that miners there pay 10 cents a ton royalty. Some years after the discovery of the Florida deposits, valuable deposits were found in Tennessee, which at one time it was supposed would seriously affect the value of the South Carolina rock. While it is hoped and believed, and there seems reasonable ground for the hope, that the phosphate rock in South Carolina may always continue to have considerable commercial value, with the vast strides made by science in the discovery of new material for fertilizers, it is a matter of speculation as to what the value of this rock will be at the time when these plaintiffs will be permitted, under their contract, to utilize it. It appears now that they have made a very good bargain, but it may possibly turn out that what now seems to be immensely valuable may not prove to be so profitable to them. At all events, with the lights before me, I cannot say that there is that gross inadequacy which "amounts in itself to conclusive and decisive evidence of fraud in the transaction." There is nothing in the contract or in the circumstances connected with it which raises any presumption of fraud. It does not fall within the class of cases such as *McCabe v. Matthews*, 155 U. S.

550, 15 Sup. Ct. 190, 39 L. Ed. 253, or *Byers v. Surget*, 19 How. 303, 15 L. Ed. 670.

The next question to be considered is whether mere hardship alone, independently of any question of fraud, furnishes ground for refusing specific performance. Fry, on Specific Performance (section 426), says:

"The cases which have been already quoted as showing that the hardship must be judged of at the time of the contract also illustrate another obvious principle, namely, that where the hardship has been brought upon the defendant by himself it shall not be allowed to furnish any evidence against a specific performance of the contract, at least whenever the thing he has contracted to do is reasonably possible."

Now, the hardship here complained of is that the defendant should be compelled to execute conveyances for property which she sold for \$20,000, and which she has since discovered to be worth a great deal more than that. Granted that she did not know at the time that there were 560 acres of her land underlaid with phosphate rock, yet it cannot be denied that means of knowledge were as open to her as to the plaintiffs, more so in fact, for she required the consent of no one to make the examination, while the plaintiffs could not go upon her land for that purpose without her consent. Her husband, under whose advice she acted, was a gentleman of unusual intelligence. He had as good opportunity to form an opinion as to what the land contained as the plaintiffs had, for it is not to be believed that the plaintiffs would have spent over \$2,500 in making their examination if they had known beforehand where the rock was and its value; and there being a full, entire, and intelligent consent to the contract at the time it was made, and as it related to a subject the value of which was a matter of speculation, I can find no principle which has the sanction of English or American courts of respectable authority which would justify me in refusing a decree for specific performance. In the Roman Law the case is different. The Constitution of Justinian fixed the arbitrary standard of one-half the real price as that which would give the sufferer the right to the interference of the court, and under the French Code a vendor may require rescission of the contract if he suffers injury to the extent of more than seven-twelfths of the price, but such is not the law of England or of any of the United States.

Fry (section 446) says:

"The general rule that the hardship of a contract is, independently of fraud, a ground for refusing a specific performance, would seem to carry with it the particular rule that inadequacy of consideration, when amounting to hardship, but not to fraud, could yet be a defense; but there appears (notwithstanding an expression of opinion from the bench to the contrary) great good sense in refusing to adopt such a rule. To make a contract with an insufficient consideration, incapable of enforcement by the purchasers, would be practically to prevent a man from selling his property at less than its value, however impossible it might be to sell it at its value, however desirous he might be to sell it for the price actually obtained, however desirable it might be for his interest that he should do so, and however unwilling or unable the purchaser might be to purchase at its full value. The rule would, when it did not stop the sale, yet further reduce the amount receivable by the vendor, because the purchaser would in effect indemnify himself for the risk he ran by offering less purchase money than he otherwise would have done. The freedom of contract, including in it the freedom to enter into enforceable contracts, should never be infringed

without sufficient cause; but, furthermore, if inadequacy of consideration short of fraud were a bar to specific performance, the question would arise as to the amount of inadequacy which should so operate—a question not easy to answer.”

I think that I have no discretion except to decree specific performance of this contract. While there are expressions in the opinions in many cases that a court of equity will not lend its aid in the enforcement of a contract where hardship or great hardship would result, I have found no well-considered case where relief from such contract has been granted, unless there were some circumstances outside of that of inadequacy which, taken in connection therewith, justified or required the court to withhold its aid. Some such expressions are found in the older cases loosely reported, where all the facts do not appear. The remarks of the Chief Justice in *Union Pacific R. R. Co. v. C. R. I. & P. R. Co.*, 163 U. S. 600, 16 Sup. Ct. 1207, 41 L. Ed. 282, seem apposite:

“The jurisdiction of courts of equity to decree the specific performance of agreements is of a very ancient date, and rests on the grounds of inadequacy and incompleteness of the remedy at law. Its exercise prevents the intolerable travesty of justice involved in permitting parties to refuse performance of their contracts at pleasure by electing to pay damages for the breach. It must not be forgotten that in the increasing complexities of modern business equitable remedies have necessarily and steadily been expanded, and no inflexible rule has been permitted to circumscribe them. As has been well said, equity has contrived its remedies so that they should correspond both to the primary rights of the injured party and to the wrong by which that right has been violated, and has always preserved elements of flexibility and expansiveness, so that new ones may be invented or old ones modified, in order to meet the requirements of every case, and to satisfy the needs of a progressive social condition, in which new primary rights and duties are constantly arising, and new kinds of wrongs are constantly committed.”

A few words as to the form of the decree: It should provide for the conveyance of the phosphate rock and phosphate deposit upon the lands containing 560.2 acres, described in the plat of Simons & Mayrant, filed in the cause. As to the location of the right of way for the railway or tramroad and the washer, let the decree direct a conveyance substantially in the form agreed upon between Mr. Von Kolnitz and Mr. H. A. M. Smith. This form of conveyance was produced under subpoena by Mr. Smith, but upon objection of the defendant the court reserved the question as to whether it was competent evidence, and upon motion of defendant's counsel the same was sealed and deposited with the clerk. I have not examined it, but as it appears to have been satisfactory to the counsel for plaintiffs, and was prepared by Mr. Smith, a kinsman and counsel of the defendant, and an eminent lawyer, I have no doubt that it makes such provision for the location of the right of way and site for the washer as is consistent with the rights of the defendant.

BREWSTER v. GOFF LUMBER CO.

(District Court, M. D. Pennsylvania, September 11, 1908.)

No. 39, February Term, 1908.

1. BANKRUPTCY—VOIDABLE PREFERENCE—PRESUMPTION OF INTENT TO PREFER.

Where the effect of a conveyance by an insolvent to a creditor within four months prior to his bankruptcy was to give such creditor a preference over other creditors, it will be conclusively presumed that it was so intended, and the conveyance is voidable if it is shown that the creditor knew or had reason to believe such fact.

2. SAME—KNOWLEDGE OF CREDITOR.

A creditor of a partnership which obtained a conveyance of his home property from one of the partners at a time when both the partnership and its members were insolvent, and within four months prior to their bankruptcy, *held*, under the evidence, chargeable with knowledge of facts which gave it reasonable cause to believe that a preference was intended, which rendered the conveyance voidable at suit of the trustee.

In Equity. On final hearing.

Fred B. Davis, William Brewster, G. F. Lazarus, and B. W. Davis, for plaintiff.

D. A. Fell and James R. Scouton, for defendants.

ARCHBALD, District Judge. This is a bill to set aside a conveyance on the ground that it is a preference. On August 7, 1907, D. B. Moore, of the firm of G. H. Moore & Son, the present bankrupts, assigned to the Goff Lumber Company—composed of W. F. and W. S. Goff—a contract which he had for a lot of land in Forty Fort, Luzerne county, Pa., on which he had built himself a residence. G. H. Moore & Son were contractors and builders, and were extensively engaged in different building operations, for which the Goff Lumber Company, who were materialmen, had furnished lumber, the amount due them therefor at the time of the conveyance in question being \$2,679.16, of which \$963.08 was for material that had gone into the D. B. Moore residence, excepting \$78 for stairs and molding, which had been agreed to be furnished and went in afterwards. The consideration for the conveyance was \$961, and was credited on the general account of the firm. The value of the property, with the title in shape and the purchase money paid, was about \$2,500, but it was held by a somewhat dubious arrangement, there being nothing but a receipt for \$50 given the preceding January by Dr. J. R. Thompson as executor of his wife, who had owned this and other lots in that vicinity, and had willed them to her minor children, the price of the lot being fixed in the receipt at \$525, and the sale being made subject to the sanction of the orphans' court of the county. Upon the strength of this paper, however, possession was taken, and a house worth \$2,000 was built, which was not quite finished at the time of the transfer, but was completed subsequently; the Goff Lumber Company, as already stated, furnishing the greater part of the material that went into it. The transfer by D. B. Moore to the Goff Lumber Company was not contemplated at the beginning, but

was adopted as an expedient. The Goff Lumber Company were pressing for the bill which was due them, and the original idea was to borrow money on the property with which to pay it. With this in view, Moore went to Mr. D. A. Fell, attorney for the Thompson estate, to try and get a deed and straighten out the title, in order to make a loan; and this led later on to Moore and W. S. Goff meeting at Mr. Fell's office on August 7th to adjust the matter. There was talk of entering a mechanic's lien for the bill, but Mr. Fell suggested as an alternative that, as the deed to complete the title would take time to secure, Moore should assign over his receipt in satisfaction of the bill, and that course was adopted, with the understanding that Moore should be entitled to redeem the property when a deed was obtained, and he was given the right to do so at any time within a year on payment of \$961, the amount with which the firm was credited. Within four months afterwards, on November 18, 1907, G. H. and D. B. Moore, individually and as a firm, filed a voluntary petition in this court, and the same day were adjudged bankrupt; and the trustee now seeks to have this transfer set aside in consequence.

That there was a preference in fact cannot, of course, be gainsaid; the firm, as well as the individual members of it, being insolvent, and the Goff Lumber Company securing by the transaction over one-third of their bill, where other creditors will get practically nothing. This being the inevitable effect, it will be conclusively presumed that it was so intended, even though it may be that Moore had no idea in reality of treating the Goff Lumber Company any differently from or of giving them any advantage over, other creditors. *Western Tie & Timber Co. v. Brown*, 196 U. S. 502, 25 Sup. Ct. 339, 49 L. Ed. 571. But the trustee must go further to make out a case, and show that the Goffs had reasonable cause to believe that they were getting a preference; and this depends on whether they might or ought to have known that Moore & Son were insolvent, as to which they were affected with whatever put them on inquiry and would lead to a disclosure, actual knowledge not being required. *Sundheim v. Ridge Avenue Bank (C. C. A.)* 16 Am. Bankr. Rep. 863, 145 Fed. 798.

It is contended on behalf of the defendants that Moore & Son were a going concern engaged in extended operations and kept on for over three months afterwards, and, while short of money, this did not necessarily import that they were insolvent, or could not pay dollar for dollar if they went into liquidation. Their credit was not impaired, as it is claimed, nor were they pressed by other creditors; the Goffs being the only ones who were any way insistent. Furthermore, except for the failure of the Society Circus, by which they lost \$5,000, their condition would not have been doubtful, and, this having only occurred in July, the result, even to themselves, was not manifest, hopes being entertained that they would still be able to get their money through the interpleader proceedings which had been instituted. The conveyance in question, moreover, was in payment for material which went into the property, and was made at the suggestion of Mr. Fell, who did not at that time represent the Goffs, in lieu of a mechanic's lien, which it was recognized that they would have a right to enter.

And the right to redeem was reserved, which Moore professedly expected to exercise when the title was straightened out, so that he could borrow money on the property, which dispelled the idea of any permanent embarrassment.

But, on the other hand, the firm were plainly in deep water, and had come to the end of their resources. Their connection with the Society Circus was well known to the Goffs, who had refused them material for it as a losing business; the urgency for the payment of their bills being directly traceable to its failure. The building operations also in which they were engaged, could not be carried on without both money and credit, and, unless capable of being brought to a successful close, were a source of embarrassment, instead of profit. But, more than that, the means of payment adopted was so unusual and extraordinary as to suggest the extreme financial difficulty which the firm was in; parting with the roof over one's head being the last thing that a man agrees to. Neither is it material that the right to a mechanic's lien was given up, if that indeed was the case, which is not fully established. Having parted with the right, they cannot go back and make good the security which they obtained by reference to it, which must be judged by its own qualities and is none the less a preference because of that which it took the place of. Besides that, the defendants did not content themselves with what a mechanic's lien would have given them, but, subject to the payment of the purchase money, absorbed the whole property. Nor is the transaction altogether able to be separated from that which followed it, by which in a few days the defendants also took over the residence of J. H. Moore, the father, the one confirming the other, although there the facts are somewhat different and the preference perhaps plainer. Nor is it of any particular account that there were judgments which were liens on the property; these having played no part in the transfer. The case may be a close one, but, all things considered, the conclusion seems warranted that the signs of insolvency were too many and too marked not to warn the defendants that they were getting a prohibited advantage over other creditors which they cannot now maintain. It is also to be observed that the grantor having reserved to himself an undisclosed interest, while apparently making an absolute conveyance, it is a question whether it was not fraudulent as to creditors aside from its being a preference. 20 Cyc. 555, 568.

Let a decree be drawn sustaining the bill, declaring the transaction complained of to be a voidable preference and directing a conveyance to the trustee, with costs.

BREWSTER v. GOFF et al.

(District Court, M. D. Pennsylvania. September 11, 1908.)

No. 40, February Term, 1908.

1. BANKRUPTCY—VOIDABLE PREFERENCE—KNOWLEDGE OF CREDITOR.

A member of a partnership having a number of building contracts on hand, and claiming to have several thousand dollars due him, but on which he could collect nothing, to satisfy an insistent creditor, conveyed his residence for the benefit of such creditor, stating at the time that it was his only available resource. Both he and the firm were, in fact, insolvent, and became bankrupts within four months. The creditor knew that the firm had recently suffered a considerable loss, and had thereafter been persistent in urging payment, and had shortly before obtained a conveyance of the residence of the other partner. *Held*, that such facts were sufficient to give the creditor reasonable cause to believe that a preference was intended and render the conveyance voidable at suit of the bankrupts' trustee.

[Ed. Note.—For cases in point, see Cent. Dig. vol. 6, Bankruptcy, §§ 255-258.]

2. SAME—EFFECT ON THIRD PERSON PARTICIPATING.

A person who participates in a transaction by which a creditor secures a preference must abide the consequences. Where a conveyance of property was made by a bankrupt, under such circumstances as amounted to a voidable preference, to the mother of a creditor, who paid the consideration agreed on, which was applied on the bankrupt's account, such creditor acting in the transaction as the agent of his mother, a bill to set aside the conveyance and directing a reconveyance of the property to the trustee of the bankrupt will be sustained against the mother, the grantee in the deed, as well as against a third person, to whom the property was attempted to be conveyed after proceedings to avoid the transaction had been taken.

In Equity. On final hearing.

Fred B. Davis, William Brewster, G. F. Lazarus, and B. W. Davis, for plaintiff.

D. A. Fell and James R. Scouton, for defendants.

ARCHBALD, District Judge. This case was heard in conjunction with a similar one against the Goff Lumber Company (164 Fed. 124), and the evidence there taken, so far as it applies, it is agreed is to be considered here also. On August 23, 1907, about two weeks after the transaction which is there in controversy, G. H. Moore, the senior member of the firm of G. H. Moore & Son, the present bankrupts, for the recited consideration of \$3,100, made a deed of his residence in Forty Fort, Pa., to Harriet M. Goff, the wife of M. F. and the mother of W. S. Goff, comprising the Goff Lumber Company. An option in writing was given by Mrs. Goff at the same time, by which Mr. Moore was to have the right to buy back the property at any time within six months for the same amount; a lease being also executed to him for six months from September 1, at \$15.50 a month rent, which was the interest at 6 per cent. on the consideration. This conveyance was

made subject to a mortgage of \$1,500 which was on the property, and two judgments amounting to \$630, which were liens against it. These having been deducted, a check was given by Mrs. Goff to the Goff Lumber Company for \$970, the difference which was credited on the account of G. H. Moore & Son. W. S. Goff admittedly acted for his mother in the transaction, and she is therefore affected with whatever came to his notice in that connection, not only by the express terms of the bankruptcy act (Act July 1, 1898, c. 541, § 60b, 30 Stat. 562 [U. S. Comp. St. 1901, p. 3445]), but on general principles; and it is not necessary, therefore, to inquire into the good faith of the purchase by her, which, however, is more than doubtful. Within three months afterwards, on November 18, 1907, G. H. Moore & Son became bankrupt, and filed a voluntary petition in this court, on which, both individually and as a firm, they were duly adjudicated. On December 14th, Mrs. Goff made a deed of the property to W. P. Morgan, the other defendant, a brother-in-law of W. S. Goff, for \$3,200; but the deed was not delivered until December 16th before which, on December 14th a petition was presented to the referee praying for an injunction, preventing Mrs. Goff from conveying or incumbering the property, on which a restraining order was granted and served the same day, before the transaction was consummated; an injunction being ordered by the court subsequently. This is controverted; it being claimed that the deed was delivered the day it bears date. But Mr. Morgan says not, his testimony being specific that December 14th was Saturday, when he was busy, and that, while he gave his check that day to Mrs. Goff, he did not go for the papers until Monday, when he also looked up the liens on the property. He being the party to be affected, his statement is controlling, and, indeed, convincing; and, the conveyance having been made after service of the restraining order, he takes nothing in the face of it. 25 Cyc. 1450. Even if this were not so, he would not be able to maintain the position of a bona fide purchaser for value. By his own admission he bought without looking at the property on the mere say-so of his brother-in-law, and, although a shrewd business man, dealing in real estate as well as other matters, he actually agreed to pay \$100 more for it—\$3,200 being the consideration in his deed—than Moore had the right to buy it back for. It is absurd to argue in the face of this that the conveyance to him was anything more than a makeshift. The courts are not so obtuse that they cannot see through such transparencies.

That the payment secured by the Goff Lumber Company, through the conveyance to Harriet M. Goff was a preference, there can be no question. And Mrs. Goff, through W. S. Goff, being a party to it, must abide by the consequences. *Roberts v. Johnson*, 18 Am. Bankr. Rep. 132, 151 Fed. 567, 81 C. C. A. 47. The conveyance was brought about in this way. By the last of August, including the bill for the D. B. Moore house, G. H. Moore & Son were owing the Goff Lumber Company some \$3,300 or \$3,400, or, taking that out, about \$2,400, and Boyle, their collector, after the failure of the Society Circus in July, by which Moore & Son lost \$5,000, was going on an average

twice a week to get it. Moore told him they could pay nothing, and that the only thing he could do was to sell them his property. Boyle was to see W. S. Goff, which he did, and later Moore himself saw him and he agreed to look at it. Moore told him that this was their only available resource, and that he would sell if he could have an option to redeem it. Goff came and examined the property and said he would try and get a buyer; the price named being \$3,100. Goff spoke to his mother and she agreed to take it. Thereupon, at his suggestion, he and Moore met at Mr. Fell's office, and the deed was made out to Mrs. Goff, six months being given to Moore to redeem it, and 6 per cent. on the price being fixed as the rental. Goff says that Moore wanted to sell in order to get money to buy material; but considering that the Goff Lumber Company, by the arrangement, was to get all over and above the incumbrances, there clearly could have been no such purpose in it. The same day they also secured \$900 in cash, which was coming to Moore & Son on the E. J. Moore building. This money was earned, but was not yet payable, and was refused to Moore, but was paid to Goff to apply on the job. Including it, the account of the Goff Lumber Company was paid up to within about \$500.

The failure of the Society Circus was undoubtedly the cause of Moore & Son's bankruptcy. This concern was sold out by the sheriff July 31st, but Moore & Son seem still to have had hopes of realizing something out of it through the interpleader proceedings which were pending, which were not disposed of until along in the fall, after which there was little question as to what would be the outcome. The money so tied up and eventually lost, as well as that which was dependent on the finishing up of their building operations, deprived them of ready cash with which to obtain new material as well as pay their men promptly and demand corresponding service, thus hampering them seriously with their various contracts. Upon inquiry by Mr. Fell, at the time of the conveyance to Mrs. Goff, Moore went over his affairs to a certain extent, stating that he had \$11,000 or \$12,000 outstanding, which he expected to get in, in a little while, and, if he did that, he would be in easy circumstances, the Goff Lumber Company being the only ones who were pressing him. On the strength of this expectation, he also undertook to take care of the two judgments, amounting to \$630, which were liens on his property. The architects, as he claimed, were holding him up on some of his jobs, and refusing to honor his orders, or give him certificates for what was due him, but upon going to certain of them, while the parties were still together, Mr. Fell was informed that this was not so, and that certificates were not given because the times for payment had not come. The amount said by Mr. Moore to be due included that which was owing by the Society Circus, which was nearly one-half of it, which inquiry would have disclosed, but nothing was, in fact, said of it. To get the rest of this money also, Moore & Son would have had to pay out for material from \$4,000 to \$5,000 which they did not have and could not command, and which would have increased their indebtedness to about \$15,000. Under the most favorable circumstances, up-

on the completion of the several buildings under way, and getting all that was due them from the Society Circus, they would only have been \$2,000 or \$3,000 ahead, and without that they would be just about that much behindhand. This was not brought out, however, at the time of the transfer, nothing being asked that would do so; Mr. Goff and Mr. Fell, except so far as inquiry was made of one firm of architects, contenting themselves with the general declaration by Moore as to the amount that was coming to him and the effect that it would have on his affairs. But the best that could be made out of it, the outlook for the firm as so presented was anything but a promising one. As said in the other case, they were evidently in deep water, and, while still a going concern, it was clearly a question how long they would be. The Goffs knew of the failure of the Society Circus, and at least in a general way the fact that Moore & Son were involved in it. They had refused to furnish material for it, as a losing venture, and immediately after it went under their collector came twice a week for his money. As W. F. Goff told the trustee afterwards, it was this that brought about the bankruptcy. By express notice also from Moore, in taking his residence, the Goff Lumber Company were getting his last available asset. A few days before they had secured a deed from D. B. Moore, the son, for his house, and now they were taking over that of his father, in view of which, and the signs of financial distress which were otherwise manifest, they assumed whatever risk there was in doing so. In re Hines (D. C.) 16 Am. Bankr. Rep. 495, 144 Fed. 543; Wright v. William Skinner Mfg. Co. (C. C. A.) 162 Fed. 315. Indeed, the very course taken throughout the whole transaction discloses the doubt which they had with regard to it, Mrs. Goff being put forward as the purchaser at first, and the title being shifted over to Mr. Morgan so as to have it if possible at a still further remove, when a contest with creditors over it was imminent. Mrs. Goff professes to have bought for investment, but she was very quick to dispose of the property when her son thought it advisable to do so. The only possible saving thing which the defendants have to rely on is that Moore said there was considerable money coming to him within a few days, and that, if he got it, he would be in easy circumstances. But the "if" was a large one, and the inquiry made by Mr. Fell of the architects showed that the statement could not be relied upon, dispelling the assurance which otherwise might be made out of it.

It is not to be denied that, as a matter of business, a creditor has the right to take all that he can get, and collect up as closely as he is able. No one, indeed, could get along without that. But that is not to say that, if the debtor at the time is manifestly in failing circumstances and does not hold out against bankruptcy for the requisite period, the creditor may not be compelled to surrender the preference which he has secured and come in pro rata with others not so favored. In the present instance, after all has been said, the case therefore comes down to this. A contractor, with half a dozen building operations on hand, and claiming to have a good many thousand dollars due him,

but of which he cannot get a penny, his orders for money being turned down, and certificates from the supervising architects being refused him, as a last expedient, to satisfy an importunate creditor, deeds over his residence to secure a quieting credit. This so clearly shows on its face that he is not only in straits, but in extremities, as to warn the creditor so preferred that whatever is secured is secured conditionally, and that, if bankruptcy intervenes within four months, the advantage cannot be retained.

Let a decree be drawn sustaining the bill, declaring that the transaction complained of was a voidable preference, and directing a reconveyance of the property to the trustee, with costs.

In re FRIEDMAN.

(District Court, E. D. Wisconsin. September 11, 1908.)

1. BANKRUPTCY—FRAUD OF BANKRUPT—CONCEALMENT OF INSOLVENCY.

Evidence that a bankrupt merchant, when in fact insolvent, purposely falsified an inventory of his stock, largely increasing the same, and used it as a basis of statements made to commercial agencies and others, that he destroyed books, which made it impossible to ascertain his transactions, and that, having previously established a fictitious credit by borrowing money from relatives with which to discount his bills, he purchased within six months before his bankruptcy a quantity of goods largely in excess of his purchases for the entire preceding year, which goods he did not pay for, and only part of which were accounted for, justify a finding that he deliberately and fraudulently concealed his insolvency for the purpose of obtaining goods on credit which he did not intend to pay for.

2. SAME—CONTEST OF CLAIMS—EVIDENCE.

On a contest of claims filed by certain relatives against the estate of a bankrupt, where it was clearly shown that the bankrupt fraudulently concealed his insolvency for the purpose of securing a large stock of goods on credit without intending to pay for the same, and that the claimants had been closely associated with him in business transactions, evidence was admissible to show that they had previously been associated together in similar fraudulent transactions.

3. EVIDENCE—WEIGHT—DIRECT AND CIRCUMSTANTIAL EVIDENCE.

If the positive evidence of an alleged fact is inherently improbable, the court is not bound to accept it as establishing such fact, but may reach a conclusion based upon circumstantial evidence which appears more convincing.

4. CONSPIRACY—EVIDENCE TO ESTABLISH—"ACTIONABLE COMBINATION."

A mere tacit understanding between conspirators to work to a common purpose is sufficient to constitute a guilty actionable combination.

[Ed. Note.—For cases in point, see Cent. Dig. vol. 10, Conspiracy, §§ 1-5.]

5. BANKRUPTCY—PROVABLE CLAIMS—CONSPIRACY TO DEFAUD OTHER CREDITORS.

When a creditor of a bankrupt participates in a scheme to defraud other creditors, and in furtherance thereof advances money or incurs expense, the entire transaction is contaminated by the fraud, and the court

will not assist the conspirators by allowing claims for such advances against the estate.

6. SAME.

Where a creditor of a bankrupt makes a claim the larger part of which is fraudulent, he is not entitled to the allowance of any part thereof.

7. SAME.

The brother and brother-in-law of a bankrupt each filed a large claim against his estate for money lent. The bankrupt was conducting a mercantile business, which had been purchased jointly by the three; the bankrupt's interest being paid for with borrowed money. Afterwards the claimants ostensibly sold their respective interests to the bankrupt, taking his notes, which were, however, ignored thereafter until his bankruptcy. Claimants thereafter made many loans to the bankrupt to enable him to discount his bills, in many cases themselves borrowing the money. By means of such discounts the bankrupt built up a fictitious credit, and on his bankruptcy was indebted in the sum of \$56,000, and the claimants indirectly purchased his stock for \$23,000 and placed the bankrupt in charge as manager. *Held*, that such evidence was sufficient to establish a conspiracy between the three to enable the bankrupt to defraud his creditors, if not in fact a joint ownership of the business, which required a disallowance of the claims.

In Bankruptcy. On review of order of referee allowing certain claims.

This is a proceeding to review the order of the referee, who has allowed certain claims of the bankrupt, as follows: Sam. J. Weinberg, \$512.37; Tillie Friedman, \$7,782.09; Hattie Saxe, \$430; Louis Friedman, \$4,941.42; E. M. Rieselbach, \$11,550.91. The dramatis personæ are as follows: Adolph Friedman, a dealer in clothing, the bankrupt; Louis and Sol. Friedman, brothers of Adolph; Tillie Friedman, the wife of Adolph; E. M. Rieselbach, a brother-in-law; Philip Saxe, a merchant of considerable means. Adolph Friedman, Louis Friedman, and E. M. Rieselbach each married a sister of Leo and Philip Saxe. Hattie Saxe is a sister of Philip and Leo Saxe, and was from time to time employed as bookkeeper by the bankrupt. Morris, Jacob, Louis, and Henry Friedman, connected with the Friedman Mercantile Company of St. Louis, are cousins of the bankrupt.

The trustee filed objections to these claims, in substance as follows: First, generally, that such amounts are not due and owing from the estate; second, that each of these creditors has, within the four-months period, received a payment from the bankrupt which amounted to a preference, and therefore ought not to participate without first paying back the several amounts so received; third, "that at the time the indebtedness claimed to exist by said claimants was alleged to have been incurred the said claimants and the bankrupts were, and for a long time prior thereto had been, unlawfully confederated together, with the false and fraudulent purpose of defrauding the creditors of said bankrupt, and the moneys so alleged to have been advanced and loaned by said claimants to the said bankrupt were then and there so advanced and loaned in pursuance to said unlawful confederation, and for the sole purpose of aiding and abetting the said bankrupt in the fraudulent design to defraud his creditors by creating for said bankrupt a false and fictitious credit, standing, or rating, by means of which the said bankrupt would be enabled to secure a large stock of merchandise upon credit without intending to pay therefor."

The evidence shows that in 1890 Adolph and Louis Friedman and E. M. Rieselbach were each carrying on a clothing business in Kentucky. At one time Louis and Adolph were partners at Philpot, Ky. Louis sold his interest in the store to Rieselbach. In 1889 Adolph purchased Rieselbach's interest for \$12,000, and paid \$2,100 on account. Rieselbach went to St. Louis. Adolph came to Milwaukee in 1902, leaving his store at Yelvington, Ky., to be run by

an employé. Louis bought the Westphal stock at Milwaukee for \$9,000. Louis claims to have advanced \$6,000 of this and Adolph \$3,000, which sum was furnished him by his wife. Louis also claims that after remaining in partnership with Adolph for about three weeks he sold his interest to Adolph. About this time Rieselbach advanced \$3,000 to Louis and took his note for that amount, which note seems to have been ignored by both parties. Louis took Adolph's note for \$2,775, ostensibly for the balance of his purchase of Louis' interest in the Westphal stock. The trustee claims that Louis, Adolph, and Rieselbach were jointly interested in the venture, and the notes given by Louis and Adolph were intended to conceal the participation of Louis and Rieselbach, and to give Adolph the status of sole trader. Adolph then owed Rieselbach \$3,000 on the purchase price of the Yelvington stock. He also claims to have owed his wife the further sum of \$2,300, advanced long before that time, and \$3,950 for a later advance by her. So that Adolph appears to have been insolvent at the time of the Westphal purchase. In 1902 the entire stock at Yelvington was destroyed by fire, and netted by way of insurance \$8,000, with which sum Adolph paid up Rieselbach his debt, of \$3,000 and also paid other debts. In 1903 Louis set up in business on his own account in Milwaukee. In August, 1905, Adolph moved to the store on Twelfth and Walnut streets.

On August 15, 1905, Adolph took an inventory (which was the last inventory he ever took), which showed stock on hand, \$16,888.65. This inventory was doctored and padded by the bookkeeper, so that the stock on hand was raised \$11,298.60, so that the bogus inventory showed, August 20th, stock on hand, \$28,187.25. There has been introduced in evidence an itemized statement, showing in detail how this fraud was practiced, nearly every item in the inventory being arbitrarily raised; and this fraudulent inventory became the basis of financial statements made by Adolph to banks and commercial agencies. August 21, 1905, the bankrupt made a statement to the First National Bank, in which he listed his merchandise on hand at \$17,000. His liabilities he scheduled: Bills payable for merchandise, \$300; open accounts, none; loans or deposits, none. By this statement the bankrupt's net worth was \$18,000. On the 25th of October, 1905, the bankrupt made another statement to the First National Bank of Milwaukee, wherein he listed his merchandise on hand as \$26,240.50, and liabilities: Merchandise accounts, \$8,265.73; loans or deposits, none; other indebtedness, none—total liabilities, \$8,265.73, making his net worth \$19,164.77. On the 10th of January, 1907, the bankrupt gave a statement to the First National Bank of Milwaukee for the purpose of procuring credit from time to time, in which he stated that his merchandise on hand was worth \$47,465; bills payable for merchandise, \$3,700; due First National Bank, \$3,500; other bills payable, \$4,000; open accounts not due, \$4,900; due relatives and employés, nothing. This statement remained unchanged until his failure, at which time he owed the First National Bank \$2,000. Other similar statements were given out to the Dun and Bradstreet agencies.

It further appears that about July, 1907, the cash book, which would have disclosed the dealings with relatives, was destroyed, and the bookkeeper made up what she called a copy of the missing book; but it was not a copy. It was apparently made up for the purpose of confusing the true situation. Later an itemized expense book disappeared, which had been kept in the store, and which would have thrown light on the situation. To show the utter worthlessness of the cash book: The expert accountant when on the stand tabulated the monthly balances of cash for 2 years, as shown by the bank account, the account kept on the stubs of check book, and the cash book. For 12 months the cash book balance, which should show total cash in bank and in store, showed a much smaller amount than was shown in the bank account alone. The account in the check book only agreed with the bank balance in a few instances, and generally they were wide apart.

Louis Friedman and E. M. Rieselbach loaned the bankrupt large sums of money to enable him to discount his bills. The volume and frequency of such loans may be shown by the following statement:

1905.	
April 8.....	\$ 100 00
September 1 (note).....	1,500 00
1906.	
January 5 (borrowed from Marshall & Ilsley Bank).....	1,188 00
February 2.....	50 00
" 21.....	250 00
April 9.....	100 00
June 6.....	100 00
" 14.....	200 00
August 11.....	150 00
September 1.....	300 00
October 11.....	1,000 00
November 12 (Marshall & Ilsley Bank, Louis and Rieselbach)	5,000 00
" 12.....	5,000 00
December 10.....	200 00
" 15 (currency).....	300 00
May 5.....	500 00
1907.	
January 11.....	500 00
" 15.....	2,500 00
" 25.....	300 00
" 28.....	500 00
March 12 (note discounted Marshall & Ilsley Bank by Louis and Rieselbach)	1,000 00
May 2.....	1,000 00
June 1.....	1,000 00
" 6.....	200 00
" 15.....	300 00
" 21.....	300 00
July 6.....	500 00
" 6 (note paid Friedman Mercantile Company).....	1,000 00
" 31.....	500 00
August 5.....	1,000 00
" 6.....	125 00
" 20.....	200 00
" 31.....	96 04
September 5 (paid Friedman Mercantile Company).....	2,000 00
" 11	200 00
" 20	909 00

Some of these advances were repaid by check by the bankrupt from time to time. Rieselbach and Louis Friedman, both being in business on their own account, were heavy borrowers at the Marshall & Ilsley Bank. They resorted to various expedients to raise this money for Adolph. Life insurance policies were hypothecated. Money was raised by their joint indorsement at the bank, and \$2,500 was advanced by Philip Saxe, for which Rieselbach and wife gave a mortgage on their homestead. At the same time the Friedman Mercantile Company was induced, by indorsements of Louis and Rieselbach, to advance \$4,000. Wolf Friedman, a cousin in New York, contributed \$1,000. Sol. Friedman contributed \$1,000. The bankrupt himself put up his insurance policies, and resorted to the desperate recourse of reshipping goods of his creditors in the original packages to relatives, who would take them, at cost, so as to raise ready money. By these and other methods the family resources were exhausted. Adolph was able to discount his bills, and in consequence obtained credit. The best houses were eager to sell him their goods, and other concerns followed their example. He was able to procure, and did procure during the last six months of his career, about \$69,000 worth of merchandise. The expert bookkeepers testify that according to the books there should have been in the store at the time of the failure \$81,000 worth of stock, whereas the stock actually inventoried, at cost prices, \$32,597.67.

The involuntary petition was filed on the 25th of September, 1907, whereby it appeared that the bankrupt owed on merchandise account \$65,868.35 and

had no assets except his stock. During the four-months period the bankrupt distributed among his relative creditors \$7,673 in cash. Upon the appointment of a receiver an emergency order was made by the court for the speedy sale of the stock of goods. The highest bid for the stock was made by Phillip Saxe, and the stock was struck off to him for \$23,400. Thereupon Louis and Rieselbach entered into a written contract to reimburse Saxe for any losses he might incur in connection with this purchase, and Tillie Friedman hypothecated her interest in the Saxe estate. The bankrupt was reinstated as manager, and the new business is conducted in the name of E. M. Rieselbach & Co., who, by the written memorandum, are to be the owners of the business as soon as all liability of Phillip Saxe has been discharged.

The referee admitted under objection testimony tending to show that these claimants were concerned in helping Leo Saxe to conceal assets when he failed some 10 years since, and that goods were shipped by Leo Saxe to Louis Friedman at St. Louis in original packages on the eve of his failure, and that Louis made him a loan thereon, and that Rieselbach, being then in St. Louis, acted for Louis Friedman in carrying out the fraudulent scheme, and also testimony of the same general nature as to the participation of Rieselbach in another alleged fraudulent scheme of the same nature.

Bloodgood, Kemper & Bloodgood, for trustee.
Harry M. Silber, for claimants.

QUARLES, District Judge (after stating the facts as above). Concerning the claim of Tillie Friedman, the wife of the bankrupt, there is evidence tending to cast suspicion upon its genuineness; but as the referee, who heard the testimony, has allowed it, I do not find sufficient evidence to warrant a reversal of his conclusion. It is claimed, however, that as within the four-months period she received in cash from the bankrupt the sum of \$700, with sufficient knowledge that it was intended as a preference, she ought to be compelled to return such sum to the trustee as a condition to the allowance of her claim. She swears expressly that she had no knowledge of her husband's business, or of his financial condition. It may be said to be quite probable that she did have knowledge; but the burden is upon the trustee to show that she had reasonable cause to believe that the amount paid to her was intended as a preference within the meaning of the bankruptcy act. In re Pfaffinger (D. C.) 154 Fed. 523. The evidence is in my judgment insufficient to overcome her positive testimony on the subject. Therefore, as to the claim of Tillie Friedman, the finding of the referee will be affirmed.

For the same reasons the conclusion of the referee as to the claim of Sam Weinberg will be affirmed.

The case of Hattie Saxe stands on a different footing. She was for a time, in 1905 and 1907, acting as bookkeeper for the bankrupt. She admits that she knew what the books showed as to the liabilities and financial condition of the bankrupt. She was concerned in the preparation of the bogus inventory of August 20, 1905, and must have been aware that it was intended for a fraudulent purpose. The "itemized expense book" of the bankrupt disappeared while she was in charge of the books in 1907. Without reviewing the testimony in detail, I find that she had reasonable cause to believe that the payment to her of \$600 on her claim shortly before the failure was intended as a preference. She drew her own check for \$600, and got

it signed, presumably because she knew what was about to happen. I therefore reverse the finding of the referee as to this claim, and hold that Hattie Saxe should not be permitted to participate in the distribution of the estate until and unless she first pays to the trustee the sum of \$600 received by her as a preferential payment within four months of the bankruptcy.

I cannot affirm the conclusion of the referee as to the claims of Louis Friedman and E. M. Rieselbach. The theory of the trustee is that the stock of goods bought by Louis Friedman of Westphal for \$9,000 was in truth and in fact a joint purchase by Adolph, Louis, and Rieselbach; that each contributed \$3,000 toward the purchase price; that Louis remained an ostensible partner with Adolph for two weeks, and then pretended to sell out his one-third to Adolph, and took a note for \$2,775 from Adolph, due in two years; that at the same time Rieselbach advanced \$3,000 to Louis as his share, but to conceal the real transaction took back a note from Louis for the \$3,000; that the conspiracy was then entered into to conceal the connection of Louis and Rieselbach in the business, but to hold out Adolph as the sole owner of the stock of goods, and, further, to secretly advance the necessary means to Adolph to build him up and to conceal his insolvency, and thus to enable him to secure a fictitious rating in the trade, to conceal the fact that they were advancing means to him, but to take notes for the amounts so advanced for their protection when necessary; that the scheme was by such false pretenses to enable him to secure a large stock of goods on credit without any purpose to pay for the same, to use the bankruptcy court as an agency to wreck the concern, and then to come forward and bid in the stock at the bankrupt sale at the lowest price and start the business again with a handsome margin of profit.

Counsel for claimants practically demurs to the evidence, and asserts that, if all these supposed facts were true, the conclusion drawn by the trustee is unsound. Counsel's contention is rested on a line of authorities of which *Field v. Siegel*, 99 Wis. 605, 75 N. W. 397, 47 L. R. A. 433, is a leading case. This line of authority is not applicable to the instant case. This is no common-law action, brought by a general creditor for damages resulting from a conspiracy to conceal the debtor's goods and prevent a recovery. This is a proceeding in a court exercising equity jurisdiction, brought to recover money advanced to the bankrupt and alleged to have been used to perpetrate a fraud and induce dealers to part with their goods when there was no purpose to pay for the same. In *Field v. Siegel* a conspiracy is set out which is not actionable. The court is at pains to say that there the purchase was made when the vendee was solvent, and to differentiate the case from the line of authorities which must govern here. The principle of law which must rule this case is laid down by the Supreme Court in *Donaldson v. Farwell*, 93 U. S. 631, 633, 23 L. Ed. 993:

"The doctrine is now established by a preponderance of authority that a party not intending to pay, who, as in this instance, induces the owner to sell him goods on credit by fraudulently concealing his insolvency and his intent not to pay for them, is guilty of a fraud which entitles the vendor, if

no innocent third party has acquired an interest in them, to disaffirm the contract and recover the goods."

The same doctrine is held by the Supreme Court of Wisconsin in *Lee v. Simmons*, 65 Wis. 523, 27 N. W. 174:

"Where, as here, a person orders goods, knowing himself to be insolvent, without disclosing his insolvency, and with the preconceived purpose of not paying for them at all, or, at most, only a very small per cent., and with the further preconceived purpose of having them swell his assets for the benefit of those whom he intends to make his preferred creditors, the purchase is fraudulent."

Many of the cases cited by claimants' attorney are discussed in the opinion. See, also, *Consolidated Mining Co. v. Fogo*, 104 Wis. 97, 80 N. W. 103.

It is a familiar principle that when one takes an assignment or mortgage of a debtor's property, and leaves the same in the debtor's possession as the ostensible owner, and conceals such transfer or mortgage, he is guilty of a fraud as to any subsequent creditor who deals with the debtor on the strength of such assets. Our recording acts are predicated on this principle. On the hypothesis of the trustee the claimants not only concealed their loans to the bankrupt, but their joint ownership in the bankrupt's goods, and allowed Adolph to appear as the sole proprietor, doing business with his own means. This was an effectual means of concealing his insolvency. It is true, as claimed by counsel, that the purchaser of goods may remain silent as to his financial condition and commit no fraud by failing to disclose his insolvency. *Adler v. Thorp*, 102 Wis. 70, 78 N. W. 184. But it is otherwise when he takes measures to conceal his insolvency to secure goods on credit.

Let us now proceed to the facts.

First. Did the bankrupt, Adolph Friedman, deliberately set out to conceal his insolvency, and to obtain goods from wholesale houses without intending to pay for the same?

Second. Did Louis Friedman and E. M. Rieselbach, knowing of such unlawful purpose, fraudulently confederate and conspire with the bankrupt to effectuate such scheme?

The evidence conclusively establishes the first proposition, and leaves no doubt in my mind of the corrupt and fraudulent intent of the bankrupt. That he was practically insolvent in August, 1905, there can be no doubt. The methods employed to conceal insolvency were as follows:

The inventory taken August 15, 1905, showed a stock of goods of \$18,085.88, according to the footing of the bookkeeper; but by a revised footing the total is \$16,888.65. When upon the stand the bankrupt testified that much of this stock was 15 or 20 years old, and was not worth to exceed 50 per cent. of the inventory price. Thereupon, instead of making a reduction for shopworn goods, this inventory was deliberately and ingeniously padded and raised from \$16,888.65 to \$28,187.25, under date of August 20th. The bankrupt adopted this fraudulent inventory as the basis of statements to banks and mercantile agencies, which went out to the trade. The bankrupt admits upon the stand that these statements were false. In none of them was the

indebtedness to the relatives scheduled, and in one of them it was expressly stated that no liability existed in favor of his relatives or employes. This is a species of fraud severely denounced by the bankruptcy act and made a criminal offense by the statutes of Wisconsin. Furthermore, the book which would have shown more of the details of the business than any other, was purposely destroyed in July, 1907, and an alleged copy of the book substituted, which was in fact a clumsy fabrication, made to facilitate the fraudulent purpose. To show the worthlessness of this book, we find entries like this, "Borrowed \$7,500," without indicating from whom borrowed, or what became of the money; and upon the stand the bankrupt, with all the books before him, was unable to tell from whom he borrowed either or any of these sums, aggregating over \$43,000. Frequent interlineations, forced balances, and erasures occur which would of themselves render the book practically worthless.

To further discredit the bankrupt's good faith it appeared in evidence that many of the sales made at wholesale to peddlers and others were not entered in any book, and never passed through the hands of the cashier, but the proceeds of such sales were pocketed by the bankrupt. It further appears that shortly before the failure six cases of goods were shipped by the bankrupt to the Friedman Mercantile Company, of St. Louis, in the original packages of the consignors, for which that company were to pay the bankrupt the cost price in cash, to furnish him ready money. It further appears that similar shipments were made to the claimants, Rieselbach and Louis Friedman, to an amount which cannot now be ascertained. As bearing upon the extent of this back-door trade, the expert accountants testified that according to the books there should have been on hand at the time of the failure goods to the amount of \$81,000, whereas in truth and in fact such goods inventoried at cost price about \$38,000. The bankrupt can make no explanation of this deficit of over \$40,000, and the books throw no light upon the subject. The books do not show the advances made and money loaned by the several relatives of the bankrupt which are the subjects of these claims. Again, the fraudulent purpose of the bankrupt is disclosed by the fact that shortly before the failure, and when he was owing over \$56,000 to merchandise creditors, he distributed \$7,600 in cash among his relatives.

In a general way the theory of the trustee is strengthened by the reckless manner in which the bankrupt conducted his business. He took no inventory after August, 1905. He had no system, and practically no books of any value, and admits upon the stand that he had no idea at any time as to how he stood. The statement of the bankrupt on the stand is illuminating:

"The way I kept the books I don't think anybody can make head or tail of them."

From the testimony of experts the books would seem to indicate that the expense of the business reached the enormous proportions of 60 per cent. of the gross sales. The bankrupt was able during the last 6 months of his business to gather in fresh merchandise to the

amount of \$69,000, which was about \$19,000 more than the purchases of the entire preceding 12 months. It further appears from the testimony of the expert bookkeepers that of the borrowed money shown by the books over \$16,000 never reached the bank or the business, and the bankrupt is unable to give any explanation of the fact. Upon such a showing the court cannot hesitate to find that the bankrupt was concealing his insolvency, so that he might obtain a large amount of goods, for which he never intended to pay.

Second. The next proposition in order is whether the claimants, Louis Friedman and E. M. Rieselbach, were aware of the fraudulent purpose of the bankrupt, and, if so, whether they confederated with him to assist in carrying it out. Bitter complaint is made that the referee erred in admitting evidence of the participation of these claimants in similar fraudulent transactions several years ago, as tending to show the intimate association of the parties, and as bearing on the question of motive. The following authorities seem to support the ruling of the referee: *Cook v. Moore*, 11 Cush. (Mass.) 213; *Butler v. Watkins*, 13 Wall. 456, 467, 20 L. Ed. 629; *Holmes v. Goldsmith*, 147 U. S. 150, 164, 13 Sup. Ct. 288, 37 L. Ed. 118; *Williamson v. United States*, 207 U. S. 425, 451, 28 Sup. Ct. 163, 52 L. Ed. 278.

There is strong support in the evidence for the theory of the trustee that the claimants were equally interested with Adolph in the original purchase and were equal proprietors in the business throughout. The note of \$2,775, which the bankrupt gave Louis for his one-third interest, was forgotten. It remained in Louis' safe, and he swears:

"I forgot all about this note, and never thought of it until just before the failure."

If the note was purely fictitious, the testimony might be true. If it actually represented \$2,775, the story is highly improbable. No indorsement was made upon this note, although he had received many payments from Adolph sufficient in amount to extinguish it. No interest upon it was ever demanded or paid. About the time of this purchase Rieselbach advanced \$3,000 to Louis, and Louis gave him a note for that amount. This note was ignored by both parties in the same way. Checks were passed back and forth between the parties, but no indorsements were made. This note was never a factor in their mutual deals or settlements. The readiness of the claimants to respond when the business needed money, the desperate efforts they made to keep it afloat, the enormous sums that they put into it, are consistent with the theory of the trustee and incomprehensible on any other hypothesis.

Louis Friedman and E. M. Rieselbach testified unequivocally that they had no knowledge of the financial condition of the bankrupt at any time. The bankrupt corroborated them in this regard, and there was slight positive evidence to the contrary. Counsel therefore argues that the court must, as matter of law, find their contention established. But such is not the law. If the positive evidence is inherently improbable, the court may reach a conclusion based upon the circumstantial evidence in the case which proves more convincing. Quock

Ting, 140 U. S. 417, 11 Sup. Ct. 733, 851, 35 L. Ed. 501. It may be remarked in passing that Mr. Landauer, a reputable wholesale merchant, testified that Rieselbach urged him to sell the bankrupt a \$700 bill by the assurance that he (Rieselbach) knew all about the bankrupt's business; that he was all right, and was honest, etc. This was denied by Rieselbach, but seems entirely credible.

While considering the complicity of these claimants, we must bear in mind the familiar principle of the law of conspiracy that, when satisfactory evidence tending to show confederation has been received, then all the disconnected acts and declarations of either of the conspirators, contributing to the common result, will bind each of the members of the conspiracy alike. Upon this principle, if the evidence shows co-operation of these claimants with the bankrupt to conceal the true condition of the business and the insolvency of the bankrupt, then these claimants would be equally bound by the fraudulent statements and practices of the bankrupt. Confederation is not to be inferred from the mere fact of the relationship of the parties; but, as the Court of Appeals of New York hold in *White v. Benjamin*, 150 N. Y. 258, 44 N. E. 956:

"Courts scrutinize with the utmost care business transactions between husband and wife, alleged to be fraudulent as against creditors, because fraud is so easily practiced and concealed under cover of the marriage relation," etc.

See *Hoxie v. Price*, 31 Wis. 82; *Blieler v. Moore*, 88 Wis. 438, 60 N. W. 792.

Books are intended to show a correct history of all business transactions. A dishonest set of books is the surest earmark of fraud, while the destruction or mutilation of books of account amounts practically to a confession. Not only were two of the bankrupt's books destroyed, but those that remained were made to conceal the debts to the family aggregating nearly \$30,000. The books of claimants were produced, and were equally defective and unsatisfactory. There are numerous checks from the bankrupt to Rieselbach, amounting to \$2,600, that were not the subject of entry anywhere. The checks of the bankrupt to Louis, produced by the trustee, would more than balance all loans made by Louis that found their way into the bank account of the bankrupt. Yet the books on both sides omit all reference to such checks. The stubs in Rieselbach's check books covering the critical period were unfortunately destroyed, which would have thrown light upon his participation in the purchase of the original stock of goods. The volume of business thus concealed, and the number of transactions thus hidden by concerted action, leave little doubt that the parties were pursuing a common purpose. In contemplation of law this amounts to confederation. A mere tacit understanding between conspirators to work to a common purpose is all that is essential to constitute a guilty actionable combination. *Patnode v. Westenhaber*, 114 Wis. 460, 90 N. W. 467.

The inference of fraud is strengthened by systematic evasion and contradictory statements of these parties on the witness stand. Louis Friedman and E. M. Rieselbach were both shrewd men, with long experience in this same line of business, and not unfamiliar with the

shifts and devices employed to defraud creditors. They had been intimately associated with the bankrupt for many years. They knew his habits and methods. They knew that when he came to Milwaukee he had nothing, but was doing business on borrowed capital. They were both engaged in business on their own account in Milwaukee, and during the time covered by this inquiry were doing business largely on borrowed capital. It is inconceivable that, with such means of knowledge at hand, they could have been ignorant of the plans and purposes of their relative Adolph Friedman. They knew he was in financial stress. They knew that in January, 1907, the banks had declined to give him greater credit, and one bank had called upon him to reduce his line. They were demanding no security. They were practically taking the risk of the business. To proceed without investigating the soundness of that business would amount to imbecility. They were practically financing the business, and Adolph Friedman was a mere figurehead therein. It was not a case where the money was advanced from an abundant surplus; but these large sums of money had to be borrowed, to be loaned again to the bankrupt, and it was procured with great difficulty. Insurance policies were hypothecated, and in one instance Rieselbach gave a mortgage on his homestead to Philip Saxe for \$2,500, to be loaned to the bankrupt. Rieselbach and Louis Friedman indorsed paper for \$4,000 to the Friedman Mercantile Company, and for other large sums to Marshall & Ilsley Bank, for the same purpose. The ostensible basis for these large advances were brotherly love—an unselfish desire to help the bankrupt to discount his bills. We are asked to believe that Rieselbach mortgaged his home for \$2,500, paying Philip Saxe 5½ per cent. interest, to enable Adolph to save a discount of 6 per cent. for cash. This overtaxes our credulity. It is apparent that this pretext of brotherly affection was a mere subterfuge. The conclusion is irresistible that these large sums of money, raised with such difficulty, were intended to give the bankrupt a fictitious rating in commercial circles. It was to conceal his true condition, and hold him out to the public as possessed of such means that he was able to discount his bills. The manifest purpose was to enable the bankrupt to gather in a large amount of new goods, for which they knew he never intended to pay, and which would eventually fall to them as spoils. It is the general understanding in commercial circles that a trader who discounts his bills is a good risk, and first-class houses are eager to sell him goods without further assurance; and that is what happened here. Goods flowed in copiously, and the wreck was brought about by the false lights set out by the claimants. It matters not whether insolvency is concealed by means of a statement or a stratagem. It is enough that the true facts were concealed from creditors and that these two relatives knowingly participated in the scheme.

When the goods were offered for sale by the receiver, Philip Saxe, a brother-in-law of Adolph Friedman, and a man of considerable wealth, was the highest bidder. He obtained the stock of goods inventoried at cost price at \$32,599.67 for \$23,400. The evidence discloses, however, that the purchase was made in the interest of the bankrupt and these claimants. Philip Saxe, while upon the witness

stand, reluctantly produced an agreement in writing whereby Rieselbach, Louis Friedman, and Tillie Friedman indemnified Saxe against loss by reason of his connection with this purchase, and whereby the business is to belong to Louis and Rieselbach after Saxe's note is paid. While the proceeds of the new business were to be deposited in the bank to the credit of "Philip Saxe, Special," the business was to be conducted in the name of E. M. Rieselbach & Co. and Louis Friedman admits that he is the company. The time had come to throw off the mask and assert ownership. The bankrupt was installed as manager. Rieselbach and Louis Friedman are really financing the new business, as they did before, and Adolph Friedman presides over a fine new stock of goods, inventoried at \$32,597.67.

Claimants' attorney has no apology to offer for Adolph Friedman's tricky methods. He protests with great vigor that his clients were ignorant of the true condition of things, and were as much surprised and as basely deceived as the other creditors. The persuasiveness of this contention is lost when his clients promptly condone Adolph's crooked transgressions and place him in charge of the new business. Even the bookkeeper, who, to baffle the creditors, destroyed the cash book, is rewarded by a reappointment. This sudden rehabilitation of Adolph by his outraged relatives is a phenomenon. We read that Lazarus was resuscitated in a miraculous way, but that was accomplished by divine intervention. Somebody has profited by this tremendous leak, whereby nearly \$40,000 worth of goods were passed out at wholesale through the back door. The evidence does not show, but it is not difficult to conceive, who reaped the illicit harvest. This may account for the freedom with which these claimants indorsed the bankrupt's paper, whenever needed, and the nonchalance manifested by Rieselbach when he pays off the notes upon which he and Louis were joint indorsers without asking for any contribution from Louis.

It is impossible, within the scope of an opinion, to refer to all the circumstantial evidence in this voluminous record that has been woven into a chain which is strong enough to induce the court to discredit the testimony of the bankrupt and the two claimants as to their knowledge of and participation in the fraudulent plan. In the case of *Mudsill Min. Co. v. Watrous*, 61 Fed. 163, 9 C. C. A. 415, the Court of Appeals of the Sixth Circuit applied to such an investigation as this the test that science uses to ascertain the truth:

"The hypothesis gains in probability by simplicity and harmony or identity with other probable or certain presuppositions. Subject to the conditions thus stated, the hypothesis has been of great value in the extraction of scientific truth, and, says Mr. Wharton in his very scientific work on Evidence, 'is of no less value in the extraction of juridical truth.' That author vindicates in the most satisfactory way the use of the hypothesis, and sums up his conclusion by saying that: 'Juridical conviction may be, therefore, defined to be the fitting of facts to hypothesis. If, in criminal issues, there is reasonable doubt whether the facts fit the hypothesis of guilt, then there must be an acquittal. In civil issues, when there are conflicting hypotheses, the judgment must be that for which there is a preponderance of proof.'"

After a most patient investigation, I find that the hypothesis of the trustee reconciles all facts and circumstances of the case. They assemble like the wheels and springs of a watch. Every circumstance

fits into place consistently with known facts and with the motives that actuate mankind, so that any other theory is practically excluded.

It is urged, however, with great confidence that, inasmuch as the evidence shows that the several sums of money represented by the notes were in fact advanced to the bankrupt, therefore these claims must be allowed. It would be a new doctrine, indeed, if a court of equity were called upon to hand back conspirators money which they have embarked in a fraudulent scheme and by means of which the fraudulent purpose has been effectuated. It has been repeatedly held that, where a fraudulent conveyance is set aside by a court of equity, no accounting is to be taken of the money which the fraudulent grantee has actually invested to secure the fraudulent conveyance. This contention of claimants is disposed of by the following authorities: *Ferguson v. Hillman*, 55 Wis. 181, 190, 12 N. W. 389, is a leading case, where a large number of authorities to the same effect are collated and cited in the opinion. This doctrine was adhered to in *Bank of Commerce v. Fowler*, 93 Wis. 241, 245, 67 N. W. 423. See, also, *In re Flick* (D. C.) 105 Fed. 503, *Burt v. Gotzian*, 102 Fed. 937, 43 C. C. A. 59, and *Lynch v. Burt*, 132 Fed. 417, 67 C. C. A. 305, both of which were decisions of the Circuit Court of Appeals of the Eighth circuit. The theory of these cases is that when a creditor participates in a scheme to defraud other creditors, and in furtherance thereof advances money or incurs expense, the entire transaction is contaminated by the fraud, and a court of equity will not practically pay a bonus upon the fraud by returning such advance or expense.

It may be claimed that the note of Louis for \$2,775 antedates the conspiracy, and on that account ought to be allowed. No one can tell exactly when this conspiracy was entered into. There are certainly several suspicious circumstances connected with the sale by Louis to Adolph of his share of the Westphal stock, out of which this note originated. It is highly probable that this note was fictitious, to be used or concealed according to circumstances. At all events, sufficient money has been paid by the bankrupt to Louis from time to time to discharge this debt. Louis claims to have forgotten about this note; which was in his safe, and he did not remember it until the time when it might be serviceable, and therefore failed to indorse upon it several sums paid by Adolph. No specific application having been made by either party, the court is at liberty to apply such payments upon this claim, which is the oldest in point of time, which payments would extinguish it. But the rule seems to be that where a creditor has interposed a claim, the larger portion of which is fraudulent, he is not entitled to any recovery, because the fraud permeates the entire account. *Levy v. Hamilton*, 68 App. Div. 277, 74 N. Y. Supp. 159; *Byrnes v. Vols*, 53 Minn. 110, 54 N. W. 942; *Fairfield v. Baldwin*, 12 Pick. (Mass.) 388. This last case was cited with approval in *Sommermeier v. Schwartz*, 89 Wis. 66, 71, 61 N. W. 311.

For these reasons I am constrained to reverse the finding of the referee as to the claims of Louis Friedman and E. M. Rieselbach, and direct the referee to disallow each of said claims.

The record will be returned to the referee for further proceedings in accordance with this opinion.

JOLINE et al. v. METROPOLITAN SECURITIES CO.

(Circuit Court, S. D. New York. September 22, 1908.)

1. PLEDGES—PLEDGE DISTINGUISHED FROM SALE.

A street railway company leased all of its lines and property for a long term. The lease provided, among other things, that on an agreement that extensions or additions to the property were required the lessee should furnish the money therefor, for which the lessor should issue its approved securities. A contract was subsequently made between them by which the lessee agreed to furnish \$8,000,000 in cash to make certain extensions and pay certain indebtedness of the lessor, which on its part agreed to issue its improvement notes for the amount to defendant, a trust company. On the same date a contract was made between the lessee and defendant, by which defendant agreed "as and when required on reasonable notice, and in any event before January 1, 1909," to furnish to the lessee such sums as might be required by it to carry out its contract with the lessor, whose notes defendant received. All of such companies were intimately related; the officers and directors being largely the same, and defendant being the owner of all of the stock of the lessee. *Held* that, construing the lease and the several contracts together, the last contract constituted a purchase by defendant of the notes of the lessor, and not a receipt of the same as collateral to an indebtedness of the lessee, and that receivers appointed for the lessee were entitled to recover from defendant the unpaid portion of the purchase money.

2. CONTRACTS—RIGHT OF ACTION—DEMAND OF PERFORMANCE.

After demand of part of the amount by the receivers and an absolute refusal by defendant to pay, no further demand beyond the bringing of suit was necessary to fix the liability of defendant.

3. SAME—CONSTRUCTION—WORDS OF DESCRIPTION.

The provision of the contract that defendant should furnish to the lessee such sums as might be required by it to carry out its contract with the lessor, a copy of which contract was attached, were words of description and not of condition, and so far as defendant was concerned it had nothing to do with the purpose to which the money due from it was applied.

In Equity. On motion for preliminary injunction.

Masten & Nichols (Joseph H. Choate, Arthur H. Masten, and Joseph D. Beatty, of counsel), for plaintiffs.

Cravath, Henderson & De Gersdorff (Paul D. Cravath and Joseph P. Cotton, Jr., of counsel), for defendant.

WARD, Circuit Judge. This is an action at law, tried before me without a jury, arising out of the following transactions:

February 14, 1902, the New York City Railway Company (then called the "Interurban Street Railway Company") leased the properties of the Metropolitan Street Railway Company for 999 years, agreeing: (1) To maintain and operate the properties; (2) to pay all taxes and assessments against the properties or against the lessor or its franchises or business; (3) to pay all rents under leases of subsidiary properties to the lessor and all lessor's fixed charges; (4) to pay 7 per cent. per annum on the lessor's capital stock, \$52,000,000, and such additional capital as should be thereafter issued with the consent of the lessee; (12 and 16) to furnish to the lessor in exchange for certain securities the sum of \$23,000,000 for the purpose of paying its floating indebtedness and providing for certain contemplated expenditures; (15) after

the \$23,000,000 has been exhausted, money for expenditures chargeable to capital account, that is, not properly chargeable to current maintenance and operation, to be provided by the lessee, the lessor issuing its securities therefor to the lessee. If the parties cannot agree that the expenditures proposed by the lessee are advisable and chargeable to capital account, and upon the nature and amount of securities to be issued by the lessor to provide for them, these questions to be determined by arbitration.

February 14, 1902, the Metropolitan Securities Company (hereinafter called the "Securities Company") subscribed for \$12,500,000 of the New York City Railway Company's (hereinafter called the "City Company") stock at par and for \$15,000,000 par of its debentures at a price to make the aggregate amount due \$23,000,000, agreeing to pay the same in such installments as should be necessary to enable the City Company to pay \$23,000,000 to the Metropolitan Street Railway Company (hereinafter called the "Metropolitan Company") as required by the lease.

May 22, 1907, the Metropolitan Company, lessor, and the City Company, lessee, at meetings of their boards settled their accounts as of May 1st as follows: The lessor admits that the lessee has paid \$23,000,000 to it, and the lessee admits that it has received the securities from the lessor, as required by the lease. The lessor admits owing \$2,574,487 (afterwards corrected to \$2,834,484.31) to the lessee for construction, for which the latter is entitled to the lessor's securities. The lessor's indebtedness, including the foregoing item, amounts to \$4,125,262 (with the above correction \$4,385,258.51), and the estimate for contemplated construction to January 1, 1909, amounts to \$4,000,000 more, to meet which it is proposed that the lessor shall issue its improvement notes to the amount of \$8,000,000 secured by certain named collateral. It will be noticed that the notes were to be issued to raise money to pay, among other things, this specific indebtedness of \$2,834,484.31.

The Metropolitan Company, lessor, and the City Company, lessee, thereupon entered into the following contract, called throughout the trial "Schedule A":

"Agreement made this twenty-second day of May, 1907, between the Metropolitan Street Railway Company, party of the first part (hereinafter called the 'Metropolitan Company'), and the New York City Railway Company, party of the second part (hereinafter called the 'City Company'):

"Whereas, the parties entered into a certain agreement of lease, dated the 14th day of February, 1902, under which the Metropolitan Company leased to the City Company for the term of nine hundred and ninety-nine years all its lines of street surface railroad owned and leased on certain terms therein more particularly stated, in which it was provided that the City Company should furnish the Metropolitan Company the sum of \$23,000,000 for the purposes therein named, and further provided that if, after the expenditure of such part of said sum of \$23,000,000 so to be paid as should be available for additional equipment, improvements, and extensions of the Metropolitan Company, it should be deemed expedient by the City Company to extend the lines of railroad demised by said lease or the lines of railroad of any subsidiary company (as therein defined), or to construct any branches of any such lines, or to provide any additional and increased equipment for, or to make any change in motive power upon, or any radical change of construction, location, or character of, any such lines, then such expenditures should be pro-

vided for by the issue of securities of the Metropolitan Company in accordance with said agreement of lease; and whereas, the \$23,000,000 so to be paid under said lease has been paid by the City Company to the Metropolitan Company, and no part thereof is available for additional equipment, improvements, and extensions, and certain other advances have been made and are to be made to or for the Metropolitan Company, for which and to provide for certain other indebtedness the Metropolitan Company is likewise obligated to issue its securities under the terms of the lease above described; and whereas, the Metropolitan Company and the City Company also entered into agreements dated February 14, 1902, and March 20, 1902, providing further terms for the payment of said sum of \$23,000,000 payable under said lease, and all the conditions of said agreements have been fully carried out and the accounts between the two companies have been stated and approved:

"Now, therefore, in consideration of the premises and the mutual covenants of the parties, it is agreed: (1) The City Company shall, as and when required, on reasonable notice, and in any event before January 1, 1909, furnish the Metropolitan Company eight million dollars in cash. (2) The Metropolitan Company shall forthwith issue and deliver to the Metropolitan Securities Company or its order its three-year five per cent. improvement notes to the face amount of \$8,000,000. Said notes shall mature July 1, 1910, and shall bear interest from July 1, 1907, at the rate of five per cent. per annum, payable semiannually on the first days of January and July in each year (with the option to the holder to declare the principal due on default in any payment of interest), and shall be payable to the Mercantile Trust Company, or bearer, as the City Company may require. For the security of said notes the Metropolitan Company assigns, transfers, and sets over to the Securities Company all claims, notes, and accounts of every kind, nature, and description which the Metropolitan Company now has and in the future may have against any of its subsidiary companies. The Metropolitan Company shall, on the reasonable demand of said Securities Company and the City Company, obtain obligations in such form as may be mutually agreed upon representing such claims, notes, and accounts, and deliver the same to the Securities Company or its nominees as additional security for said improvement notes issued in accordance with this agreement, and the Metropolitan Company shall, from time to time, for its said improvement notes, at the request of the City Company, substitute 'collateral improvement notes' of the same terms and amounts and secured by such collateral. Subsidiary companies under the terms of this agreement shall be construed to mean such companies as are leased to or operated by any of the parties hereto, or of which the majority of the capital stock is owned or held at the date of this agreement by the parties hereto or said Securities Company. (3) Said Securities Company shall have the right to pledge and hypothecate said improvement notes of the Metropolitan Company, accompanied by all the collateral therefor delivered hereunder, and to allow the pledge and hypothecation of the same for obligations of the Interborough-Metropolitan Company issued for the purpose of raising moneys to be advanced to said Securities Company, such pledge and hypothecation to be in such amounts and on such terms as the Interborough-Metropolitan Company in its discretion may see fit."

On the same day the City Company, lessee, entered into the following contract with the Securities Company, called throughout the trial "Schedule B":

"Agreement made this 22d day of May, 1907, between the New York City Railway Company, party of the first part (hereinafter called the 'City Company'), and the Metropolitan Securities Company, party of the second part (hereinafter called the 'Securities Company'):

"The parties hereto entered into a certain agreement, dated February 14, 1902, providing for the furnishing of certain sums by the Securities Company to the City Company, and the issue therefor by the City Company to its stock and its ten-year debentures therein described. The accounts between the parties thereunder have been stated and approved, and the Securities Company has fulfilled all its obligations for subscription of stock of the City

Company thereunder, and is the holder of certain of ten-year debentures of the City Company issued thereunder, and is obligated thereunder to subscribe and pay for additional ten-year debentures. The City Company has entered into an agreement of even date with the Metropolitan Street Railway Company (a copy of which is hereto attached), under which the Metropolitan Street Railway Company has, at the request of the City Company, delivered, or is about to deliver, to the Securities Company, its three-year five per cent. improvement notes to the face amount of \$8,000,000, as in said agreement described:

"Now, therefore, in consideration of the premises and the mutual covenants of the parties hereto, it is agreed: (1) Said agreement of February 14, 1902, and all obligations hereunder are canceled with the consent of both parties, and all ten-year debentures of the City Company received under said agreement and now held by the Securities Company shall be forthwith redeemed by the City Company at the same rates as the same were delivered under said agreement. (2) The Securities Company shall, as and when required, on reasonable notice, and in any event before January 1, 1909, furnish to the City Company such sums as may be required by it to carry out the attached agreement by it with the Metropolitan Street Railway Company, and will also advance to it such other sums as may be required by the City Company before January 1, 1909, against the issue of demand notes of the City Company therefor of the same face amount as such advances, payable to the Securities Company, or its order, or its nominees, as it may require, and bearing interest at the rate of six per cent. per annum. (3) The City Company agrees to assign, transfer, and deliver, and hereby assigns, transfers, and delivers, to the Securities Company all the shares of stock and securities set out in Schedule A hereto attached at the values therein stated; payment to be made forthwith by the canceling of obligations of the City Company held by the Securities Company to the same aggregate face amount as to the aggregate of such values set out in Schedule A. (4) The amount of interest on the improvement notes of the Metropolitan Company issued and delivered to the Securities Company shall be adjusted on each half-yearly interest day on the basis of such amounts as may from time to time have been advanced hereunder to the City Company for the fulfillment of its obligations to the Metropolitan Company under the annexed agreement between said companies."

On the same day the Securities Company entered into a contract with the Interborough-Metropolitan Company (hereinafter called the "Inter-Met Company"), whereby the latter agreed to advance \$15,000,000 to the former against its 6 per cent. demand notes secured by the Metropolitan Company's improvement notes and certain other securities. On the next day the Inter-Met Company entered into an agreement with the Mercantile Trust Company, as trustee, whereby the latter agreed to certify the former's three-year collateral trust notes to the amount of \$15,000,000 against securities, including, among others, improvement notes of the Metropolitan Company, deposited with it. June 4, 1907, the Metropolitan Company approved a scheme of contemplated construction submitted by the general manager of the City Company, estimated at \$4,000,000.

These companies, except the Mercantile Trust Company, were all closely related to each other and interested in the same general operation. The Inter-Met Company owned 96 per cent. of the stock of the Securities Company, and the Securities Company owned the entire capital stock of the City Company. Copies of the contracts of May 22d between the Metropolitan Company and the City Company (Schedule A) and between the City Company and the Securities Company (Schedule B) were annexed to the originals of each, respectively, and to the contract between the Securities Company and the Inter-Met

Company. The same person was president of the Metropolitan Company and of the City Company. Each company had a board of nine members, and four persons were directors on both boards, and all the directors of the Securities Company were directors of one or both of the other companies. The effect of the documents executed on May 22, 1907, was to settle accounts between the Metropolitan Company and the City Company and between the City Company and the Securities Company, and to provide funds to pay for the indebtedness of the Metropolitan Company, described as accrued and to accrue, to an amount exceeding \$8,000,000.

September 24, 1907, the plaintiffs were appointed by this court receivers of the City Company, and on October 1st receivers of the Metropolitan Company. October 11, 1907, the plaintiffs, as receivers of the City Company, called upon the defendant for \$1,245,754.33 under its contract (Schedule B), to which the defendant answered October 18th that it was advised by counsel that, the Metropolitan Company and City Company having become insolvent, it was under no obligation to make further advances to the City Company or its receivers. March 7, 1908, this suit was brought to recover \$4,964,000, the whole balance of \$8,000,000 unpaid by the defendant.

The kernel of the controversy is the construction of article 2 of the agreement of May 22, 1907 (Schedule B), between the City Company and the Securities Company. The plaintiffs contend that it shows a purchase by the Securities Company of the Metropolitan Company's notes, and a promise to pay over to the City Company, on reasonable notice, before January 1, 1909, the sum of \$8,000,000, and, only \$3,036,000 having been so paid over, they bring this suit to recover the balance. The defendant, on the other hand, insists that it shows an agreement of the Securities Company to lend the City Company up to \$8,000,000, the Metropolitan Company's notes being collateral to the obligation of the City Company, either expressed or to be implied, to repay, and therefore it makes a claim against the City Company for the amount actually advanced, \$3,036,000 and interest, for which it holds the Metropolitan Company's notes as collateral, with no obligation to make further advances because of the insolvency of the Metropolitan Company and the City Company.

Neither construction is free from difficulty. If the transaction was a sale of the Metropolitan Company's notes to the Securities Company, there was no necessity for article 3 in the contract between the Metropolitan Company and the City Company (Schedule A), authorizing the Securities Company to hypothecate the notes with the accompanying collateral and to permit the Inter-Met Company to do the same thing. The owner of a note accompanied by collateral has a right to sell or hypothecate it with the collateral, though he cannot hypothecate the collateral separately for any other indebtedness. Whereas, if the notes were held as collateral to the obligation of the City Company to repay, the Securities Company could not pledge them except as accompanying that obligation. Therefore the provision may be either an attempted limitation of the ordinary rights of the Securities Company, if a purchaser of the notes, or a privilege to it, if a lender to

the City Company with the notes as collateral. In the latter case the privilege should have been given by the City Company in its agreement with the Securities Company (Schedule B), and not by the Metropolitan Company, in Schedule A, as it has no contract with the Securities Company. On the other hand, if the notes were delivered as collateral, who was the principal debtor? For the expenditures themselves, evidently, the Metropolitan Company, as between itself and the City Company. That being the case, there is no apparent reason why the latter should assume any personal liability for them, although, being the lessee and operator of the property, it was natural that it should secure and apply the funds to be raised on the credit of the lessor. Article 2 of Schedule B calls for no promise to repay the \$8,000,000 from the City Company, although it expressly provides that advances other than the \$8,000,000 are to be made against the City Company's demand notes. In the very next of this series of contracts, viz., that between the Securities Company and the Inter-Met Company, made on the same day, the Inter-Met Company agrees to advance against the Securities Company's demand notes; and, although over \$3,000,000 was paid by the Securities Company to the City Company, no note or acknowledgment was asked from or given by the City Company.

I think these contracts were intended to effectuate the provision of article 15 of the lease that the lessor would deliver its securities, in a form and amount to be agreed upon or determined by arbitration, to the lessee, to enable it to raise money for expenditures chargeable to capital account. The Metropolitan Company had under article 15 the right to issue its securities with the consent of the City Company for so much of the indebtedness as the City Company was not liable for. The unnecessary provision of article 3 of Schedule B as to hypothecation is not sufficient, merely because more consistent with a loan, to overcome the otherwise plain intent of the parties. I therefore find that this was a sale by the City Company of the Metropolitan Company's notes to the Securities Company, and not an agreement by the Securities Company to lend money to the City Company with the notes as collateral. Insolvency of the Metropolitan Company and the City Company, each of which has performed its contract obligations, would be no defense to the defendant for nonperformance of its obligation to pay for what it had received.

I will now briefly mention some other considerations discussed by counsel, to show that they have not been overlooked.

The journal entries in the books of each company are a bookkeeper's form of expressing what took place, and I think can be read consistently with the theory of either party.

The conduct of the defendant in filing claims against the companies seems to me consistent with its theory. November 29, 1907, it filed its claim against the City Company for \$3,036,000, the amount actually paid out, and this must have been on the theory that it was lending to the City Company. February 1, 1908, it filed its claim for the whole \$8,000,000 of improvement notes against the Metropolitan Company. This was exactly what a holder (which, however, the de-

fendant was not) of the notes as collateral should have done. No one could tell, in the condition of the Metropolitan Company, whether the notes would produce \$3,036,000, and, if they did produce more, the surplus would go to the Metropolitan Company. May 23d it modified its notice of February 1st by limiting its claim to the amount actually advanced.

The provision of article 4 of Schedule B seems to me consistent with a sale by the City Company of the notes to the Securities Company, because it is liable under article 3 of the lease to pay the interest on the notes as a fixed charge.

I do not think that the exception pointed out in *Roehm v. Horst*, 178 U. S. 1, 20 Sup. Ct. 780, 44 L. Ed. 953, to the doctrine of *Hochster v. De la Tour*, 2 El. & Bl. 678, viz., that it does not apply to contracts for payment of money merely, has any application to the contract (Schedule B) because it was not a promise to pay upon a fixed future date, but upon reasonable notice before January 1, 1909, and reasonable notice was given by the plaintiffs October 1, 1907, for \$1,245,754.33, and after the defendant's absolute refusal to pay reasonable notice was given for the whole balance by the institution of this action March 8, 1908.

The defendant further insists that under any circumstances it is not bound either to loan or to pay a definite sum, but only such moneys as may be required by the City Company to fulfill its contract with the Metropolitan Company; i. e., construction expenditures incurred after May 22, 1907, subsequently formulated in the report of the general manager of the City Company to the board of the Metropolitan Company and adopted by resolution June 4, 1907—the amount of money so required not to be more than \$5,165,516.79, the balance after deducting from \$8,000,000 the \$2,834,483.21. It is said that the plaintiffs, not having shown any such expenditures in excess of \$3,036,000, the sum already paid, are entitled to recover nothing. No doubt, as between the Metropolitan Company and the City Company, the latter had to furnish after May 22d only \$5,165,516.79, because it had already furnished \$2,834,483.21; but it was the expressed intention of both the Metropolitan Company and the City Company that the latter should be reimbursed out of the Metropolitan Company's \$8,000,000 improvement notes delivered to the Securities Company, and that was the requirement of the lease. I think the Securities Company has no standing to say the contrary, or to offset the City Company's payment before May 22, 1907, against its promise to pay the City Company \$8,000,000 on demand.

The language relied upon, viz., that the Securities Company shall "furnish to the City Company such sum as may be required by it to carry out the attached agreement by it with the Metropolitan Street Railway Company," are words of description, and not of condition. It is another way of saying that the Securities Company is to pay \$8,000,000, and has nothing to do with the application of the money. The City Company and the Metropolitan Company might alter as they chose the nature of the expenditures. It can hardly be supposed that in this large operation they intended to submit the character of the improvements to be made to the Securities Company. Whatever the

Metropolitan Company agreed upon as a capital charge was to be a capital charge. The parties could change and rechange the character of the expenditures as much and as often as they pleased without in any way affecting the liability of the Securities Company. When the plaintiffs became receivers of both properties, they took the places of the lessor and lessee, which had fully executed the obligations under the contracts of May 22, 1907. Being disinterested officers of the court, they can, under the direction of the court, call as receivers of the City Company upon the defendant for the payment of the money and apply it in accordance with the lease to such expenditures upon the property of the Metropolitan Company as they find are necessary and chargeable to capital account as distinguished from maintenance and operation. I find that they have done so with reasonable notice to the defendant.

Finally, the defendant contends that under the contract, even construed as an absolute promise to pay, it is entitled to a credit of \$503,-833.33. Part of the indebtedness of the Metropolitan Company intended to be covered by the proceeds of its \$8,000,000 of notes consisted of an indebtedness due by it to the Central Crosstown Railroad Company. This indebtedness the defendant, without consulting the plaintiffs, as receivers of the City Company, voluntarily paid directly to the Metropolitan Company, as far as I can make out from the somewhat contradictory documents and testimony, under the following circumstances:

The Metropolitan Company had in the Morton Trust Company a special account, called "The Metropolitan Street Railway Company, Central Crosstown Railroad Company Special Construction Fund," being \$814,931.12, proceeds of sale of the Central Crosstown Railroad Company's securities. This fund the Metropolitan Company held under article 12 of the lease of the Central Crosstown Railroad Company's property, dated February 12, 1904—

"to be applied to the payment of the construction debts and unfunded liabilities of the lessor as of the date when this lease goes into effect, and to defray the expense of acquiring such additional equipment and other property, real or personal, and doing such construction as in the opinion of the lessee shall be necessary or proper in the management and operation of the leased railroads, including the lines of the said Christopher & Tenth Street Railroad Company leased to the lessor hereunder as hereinabove set forth."

The Metropolitan Company lent \$500,000 out of this fund to the Securities Company and \$300,000 to the City Company. The Securities Company repaid the loan to the Metropolitan Company, and the Metropolitan Company kept the amount as borrowed by itself. Mr. Moorehead, the secretary and treasurer of the Metropolitan Company, says that he received a check from the Securities Company for \$800,000, dated September 25, 1907, which was deposited in the Metropolitan Company's general account in the Morton Trust Company, and that on the same day he delivered the check of the Metropolitan Company for \$814,931.32 to August Belmont & Co., to be held as a special deposit to the credit of the Central Crosstown Railroad Company.

No doubt this was what was done, though the day on which it was done is by no means clear. The letter of the Securities Company, in-

closing the check to the Metropolitan Company to be deposited in the special construction fund of the Central Crosstown railroad Company, is dated October 1st while the letter of the Metropolitan Company to August Belmont & Co., inclosing check for \$814,931.32, is dated September 24, 1907. I am compelled to infer that the payment, whenever made, was made to protect the Metropolitan Company in respect to this use of the Crosstown Company's construction fund, and that it was intentionally made, without consulting the receivers of the City Company, so as to insure payment to this special account out of the funds due from the Securities Company. I do not think that the Securities Company is entitled to any credit for this payment under the contract of May 22d, against the plaintiffs' objection.

The defendant's motion to dismiss the complaint on the merits is denied, and judgment may be entered for the plaintiffs in the sum of \$4,964,000, with interest at 6 per cent. per annum on \$1,245,754.33 thereof from October 18, 1907, and on \$3,718,245.67 from March 8, 1908.

UNITED STATES ex rel. FUNARO v. WATCHORN.

(Circuit Court, S. D. New York. August 14, 1908.)

1. HABEAS CORPUS—FEDERAL COURTS—VERIFICATION OF PETITION.

Where, because of infancy, incompetency, or lack of time, a petition for a writ of habeas corpus in a deportation case cannot be verified by the applicant as required by Rev. St. § 754 (U. S. Comp. St. 1901, p. 593), it may be verified by his attorney.

2. ALIENS—IMMIGRATION LAWS—CONSTRUCTION OF DEPARTMENT RULES.

The language of rule 4 of the regulations of the Bureau of Immigration and Naturalization relating to the admission and exclusion of aliens that "the provisions of the immigration act do not apply to aliens who have once been duly admitted to the United States, or to any waters, territory, or other place subject to the jurisdiction thereof, proceeding to or from the continental territory of the United States," applies only to aliens who have been admitted to the United States or its dependencies, and are proceeding either from the dependencies to the continent, or from the continent to the dependencies, and has no application to an alien arriving from a foreign country, although he has been previously admitted.

3. HABEAS CORPUS—PROCEEDINGS REVIEWABLE—DECISIONS OF IMMIGRATION OFFICERS—CONCLUSIVENESS.

Under Immigration Act Feb. 20, 1907, c. 1134, § 25, 34 Stat. 906 (U. S. Comp. St. Supp. 1907, p. 405), the decision of the appropriate immigration officers adverse to the admission of an alien is conclusive, unless reversed on appeal by the Secretary of Commerce and Labor, and cannot be reviewed by the courts on writ of habeas corpus.

Habeas Corpus.

Giuseppe Maggio, for relator.

Felix Frankfurter, for respondent.

WARD, Circuit Judge. The petitioner came originally to this country in 1901, and lived for six years at Pittsburg, in the state of Pennsylvania, where he established his domicile. In December, 1907, he went to Italy for a visit, and upon his return to this country May 8,

1908, was detained by the immigration inspector as a person "not clearly and beyond a doubt entitled to land." Act Feb. 20, 1907, c. 1134, § 24, 33 Stat. 906 (U. S. Comp. St. Supp. 1907, p. 404). At the hearing before the board of special inquiry the petitioner admitted that two years before his first arrival in this country he had stabbed a man with a knife who had slapped his face, and that he was convicted of this crime and sentenced to imprisonment for three months. The board unanimously decided to exclude him from admission, under section 2 of the act, as having been convicted of "a crime involving moral turpitude" before his arrival. Thereupon his attorney signed and verified a petition for a writ of habeas corpus on the ground that the act does not apply to an alien who has previously been admitted to this country and established his domicile here. This writ was dismissed, and the petitioner remanded, under the case of *In re Kleibs* (C. C.) 128 Fed. 656, but an opportunity was afforded to permit an appeal. Instead of appealing, the petitioner's attorney, thinking that the original petition was irregular under section 754, Rev. St. U. S. (U. S. Comp. St. 1901, p. 593), because signed and verified by him, filed the present petition, duly signed and verified by the alien himself, and setting up as additional grounds for his discharge rule 4 of the regulations of the Bureau of Immigration and Naturalization of the Department of Commerce and Labor, and the further objection that the crime of which the alien was convicted did not involve moral turpitude.

Notwithstanding the language of section 754, it has been the frequent practice in this district to present habeas corpus petitions in deportation cases signed and verified by others than the person detained. In such cases, often for lack of time, as well as because of infancy or incompetency, it would be impossible to present a petition signed and verified by the person detained, and the language of section 760 plainly contemplates petitions so executed. Rule 4, relating to the admission and exclusion of aliens, reads as follows:

"Rule 4. Application of Immigration Act.—The provisions of the immigration act apply to all aliens seeking to enter the United States, except accredited officials of foreign governments, their suites, families, and guests. The act also prescribes the conditions of their admission to or exclusion from the United States, or any waters, territory, or other place subject to the jurisdiction thereof, except the Isthmian Canal Zone. The act becomes effective when such aliens arrive from any foreign country, or other place without the jurisdiction of the United States, or from the Canal Zone. The provisions of the immigration act do not apply to aliens who have once been duly admitted to the United States, or any waters, territory, or other place subject to the jurisdiction thereof, proceeding to or from the continental territory of the United States, except aliens coming from the Canal Zone, and except Japanese or Korean laborers coming from Hawaii, with passports limited to Hawaii, Mexico, or Canada. The admission of aliens coming from the Canal Zone is governed by the regulations applicable to aliens generally. The admission of Japanese or Korean laborers to the continental territory of the United States is governed by the provisions of the executive order of the President embodied in rule 21 hereof."

The words relied upon by the petitioner are:

"The provisions of the immigration act do not apply to aliens who have once been duly admitted to the United States, or any waters, territory, or other place subject to the jurisdiction thereof, proceeding to or from the continental territory of the United States, except aliens coming from the Canal Zone, and

except Japanese or Korean laborers coming from Hawaii, with passports limited to Hawaii, Mexico, or Canada."

This language is certainly exceedingly obscure, but I think it must be intended to apply to a different class of aliens than those mentioned in the previous sentence as arriving "from any foreign country or other place without the jurisdiction of the United States or from the Canal Zone." It must apply to aliens (with certain immaterial exceptions) who have been admitted to the United States or its dependencies, and are proceeding either from the dependencies to the continent, or from the continent to the dependencies. Accordingly this provision does not apply to the petitioner, who arrived from a foreign country, and not a dependency.

Act Aug. 18, 1894, c. 301, § 1, 28 Stat. 390 (U. S. Comp. St. 1901, p. 1303), provides:

"In every case where an alien is excluded from admission into the United States under any law or treaty now existing or hereafter made, the decision of the appropriate immigration or customs officers, if adverse to the admission of such alien, shall be final unless reversed on appeal to the Secretary of the Treasury."

The jurisdiction of the Secretary of the Treasury was subsequently transferred to the Secretary of Commerce and Labor.

The Circuit Court of Appeals of the Third Circuit in *Rodgers v. United States*, 152 Fed. 346, 81 C. C. A. 454, and of the Sixth Circuit in *United States v. Nakashima*, 160 Fed. 842, have made it clear that their construction of the act of 1903 accords with that of the petitioner, viz., that an alien who has been admitted to the United States and established a domicile here is not subject to exclusion upon his return to this country. But in the first case the alien was discharged on the ground that he had not been afforded an appeal, and in the second an appeal upon this particular question to the Secretary of Commerce and Labor. For these reasons the courts held there was no final decision in those cases. If upon such an appeal the Secretary had affirmed the board in the one case, or the collector in the other, it is plain that the courts would have considered the decisions as final. And this appears to follow necessarily from the cases of *Lem Moon Sing v. United States*, 158 U. S. 538, 15 Sup. Ct. 967, 39 L. Ed. 1082, and *United States v. Ju Toy*, 198 U. S. 253, 25 Sup. Ct. 644, 49 L. Ed. 1040, and *Pearson v. Williams*, 202 U. S. 281, 26 Sup. Ct. 608, 50 L. Ed. 1029.

In the *Case of Gonzales*, 192 U. S. 1, 24 Sup. Ct. 177, 48 L. Ed. 317, to which the petitioner refers, the question was one of law as to the citizenship of the petitioner, going to the foundation of the jurisdiction of the immigration officers.

In this case, however, it being admitted that the petitioner is an alien, their jurisdiction is not open to dispute, and the only question is whether they have given an erroneous construction to the act in relation to this alien.

What has been said is equally true of the construction put by the board upon the words "crimes or misdemeanors involving moral turpitude." Such a crime of violence as described by the petitioner,

which was provoked by an unjustifiable assault, does not seem to involve moral turpitude; but the board may have inferred from the fact that the Italian courts sentenced him to imprisonment that they found his act to have been willful and wrongful.

The writ is dismissed, and the petitioner remanded; but, to give an opportunity for appeal, let the United States attorney give five days' notice of the entry of an order hereafter.

HARRISON SUPPLY CO. v. UNITED STATES.

(Circuit Court, D. Massachusetts. July 27, 1908.)

No. 110 (1,756).

1. CUSTOMS DUTIES—CLASSIFICATION—"IRON SAND"—"IRON MANUFACTURED."

So-called "iron sand," a completed article produced by a series of manufacturing processes from cast iron and steel scrap, is not within the provision for "all iron in * * * forms less finished than iron in bars, and more advanced than pig iron," in Tariff Act July 24, 1897, c. 11, § 1, Schedule C, par. 124, 30 Stat. 159 (U. S. Comp. St. 1901, p. 1636), but is dutiable as "iron manufactured," under paragraph 193, 30 Stat. 167 (U. S. Comp. St. 1901, p. 1645).

2. SAME—"UNWROUGHT METALS."

Iron sand, a completed article manufactured from cast iron and steel scrap, is not dutiable as "unwrought metals," under Tariff Act July 24, 1897, c. 11, § 1, Schedule C, par. 183, 30 Stat. 166 (U. S. Comp. St. 1901, p. 1645).

[Ed. Note.—For other definitions, see Words and Phrases, vol. 8, p. 7221.

Interpretation of commercial and trade terms in tariff laws, see note to Dennison Mfg. Co. v. United States, 18 C. C. A. 545.]

On Application for Review of a Decision by the Board of United States General Appraisers.

Searle & Pillsbury and Hatch & Clute (Walter F. Welch, of counsel), for importers.

William H. Garland, Asst. U. S. Atty.

LOWELL, Circuit Judge. This was an importation of material variously called "iron sand," "iron shot," "iron grit," "steel shot," or "diamond steel." It is used for sawing and polishing granite and stone, and for like purposes. The method of its manufacture is thus described by the manufacturer:

"It is manufactured by melting together in a furnace a mixture of cast iron and steel scrap, which, while in the furnace, is decarburized by the action of an air blast, thereby converting it into steel of about 1.55 per cent. carbon. The liquid steel is then allowed to flow out of the furnace onto a stream jet, which scatters it in a shower of particles of various sizes into a pond of cold water. The water is then run off, and the particles of steel are collected, dried, and separated into the various grades by passing them through riddles or sieves. The material is then put up in bags and labeled according to the various grades, which range from about the size of buckshot down to fine dust."

Notwithstanding this statement, it is admitted that the material is chemically iron, and not steel; the proportion of carbon being not less than 2.33 per cent., a percentage too high for steel.

By proper protest the importers set up that the importation was dutiable under paragraph 124 of the Dingley tariff act (Act July 24, 1897, c. 11, § 1, Schedule C, 30 Stat. 159 [U. S. Comp. St. 1901, p. 1636]), or, in the alternative, under paragraph 183. The Board of General Appraisers affirmed the decision of the collector, holding the importation dutiable under paragraph 193. The material parts of these paragraphs read as follows:

Paragraph 124: "Provided, that all iron in slabs, blooms, loops, of other forms less finished than iron in bars, and more advanced than pig iron, except castings, shall be subject to a duty of five-tenths of one cent per pound." 30 Stat. 159.

Paragraph 183: "Metallic mineral substances in a crude state, and metals unwrought, not specially provided for in this act, twenty per cent. ad valorem; monazite sand and thorite, six cents per pound." 30 Stat. 166.

Paragraph 193: "Articles or wares, not specially provided for in this act, composed wholly or in part of iron, steel, lead, copper, nickel, pewter, zinc, gold, silver, platinum, aluminum or other metal, and whether partly or wholly manufactured, forty-five per centum ad valorem." 30 Stat. 167.

For earlier statutes, see 22 Stat. 497; 26 Stat. 574; 28 Stat. 515.

The merchandise in question is not specifically described in any paragraph of the Dingley act. Its classification must be sought in the more general language of the tariff. If it can fairly be brought within the iron schedule, it belongs there, being iron unmixed with any other metal. This consideration points to paragraph 124, as paragraphs 183 and 193 are both outside the iron schedule; but it is hard to find a place for the importation within that schedule. The first paragraphs of the schedule begin with iron in its earliest state, and proceed with increasing duties through the stages of manufacture. Thus paragraph 121 deals with iron ore, dutiable at \$1 a ton; paragraph 122 with pig iron, etc., dutiable at \$4 a ton; paragraph 123 with bar iron, etc., dutiable at \$12 a ton; paragraph 124 with round iron, etc., dutiable at \$16 a ton. Paragraph 124, however, has ill-arranged provisos harking back to earlier stages of manufacture, and imposing duties of \$10 and \$12 a ton. Two of the importer's witnesses, Little and Billings, whose evidence was not before the Board of General Appraisers, testified that the importation was "more advanced than pig iron" and "less finished than iron in bars." This testimony does not impress me strongly. Little twice denied that the material was more advanced than pig iron (interrogatories 12, 13), though he asserted the contrary immediately afterwards (interrogatories 17, 22). He had never seen the material. Billings was so little informed concerning it that he called it an alloy. The government introduced no testimony to meet this inconclusive evidence; but even if the importation be capable of classification with reference to pig iron and bar iron, its price and the nature of its manufacture appear to put it not lower in the scale of development than the latter. I agree, however, with the Board of General Appraisers that the importation cannot be treated as comparable with iron ore, pig iron, bar iron, round iron, etc., in

the advancing manufacture of iron. It is rather a separate manufacture, aside from the ordinary line of development. Paragraph 183 is out of the question, and the decision of the Board of General Appraisers holding the importation dutiable under paragraph 193 is affirmed.

UNITED STATES v. GRODSON et al.

(District Court, N. D. Illinois, E. D. September 28, 1908.)

CONSPIRACY—CONSPIRACY TO COMMIT OFFENSE AGAINST UNITED STATES—CONCEALMENT OF PROPERTY BY BANKRUPT.

An indictment against a bankrupt and others, charging a conspiracy to conceal property of the bankrupt from his trustee in violation of the bankruptcy act, does not charge an offense under Rev. St. § 5440 (U. S. Comp. St. 1901, p. 3676), where it shows that the conspiracy was formed and the property removed and concealed by defendants prior to the bankruptcy, but does not aver that it was in contemplation of bankruptcy, or that any overt act was committed after the bankruptcy, although it charges a further conspiracy thereafter to continue the concealment.

On Demurrer to Indictment.

Edwin W. Sims, Dist. Atty., and Charles L. Abbott, for the United States.

Blum & Blum, for defendants.

SANBORN, District Judge. Demurrer to indictment for conspiracy. It is made an offense by the bankrupt law for the bankrupt to conceal property from the trustee. The act applies only to the bankrupt, and does not make it criminal for any other person to conceal the bankrupt's property for the purpose of preventing the trustee from receiving it. *Field v. U. S.*, 137 Fed. 6, 69 C. C. A. 568. The indictment is challenged because, as it is argued, it does not allege a conspiracy to aid the bankrupt to conceal his property, but alleges a conspiracy, formed before the bankruptcy, that all the three defendants should so conceal.

From the first count it appears that the defendant Frederick Craber was adjudged bankrupt on July 6, 1907, on involuntary petition, and his trustee was appointed July 30, 1907. In April and May, 1907, Craber was in the retail clothing business in Chicago, and became insolvent, and the defendants Grodins and Grodson knew of such insolvency. Thereupon the three defendants arranged to have a large amount of Craber's stock, of the value of \$4,164, shipped from his store to the defendant Grodins, and they were so shipped, and remained concealed until June, 1908, not being given up by Grodins or the other defendants to the trustee in bankruptcy. No overt act of concealment occurred after the bankruptcy. All that was done was for defendants to fail to discover the goods, or inform the trustee of their existence or place of concealment, and to fail to turn them over. Section 5440, Rev. St. (U. S. Comp. St. 1901, p. 3676), provides that if two or more shall agree together to commit an offense against the United States, and one of them shall do any act to effect the object

of the conspiracy, all of them shall be punished. Under this statute there must be an agreement to commit an offense, and then some overt act to carry it out. *Dealy v. United States*, 152 U. S. 539, 14 Sup. Ct. 680, 38 L. Ed. 545. If the defendants had agreed, before the bankruptcy, to combine in order to enable Craber to go into bankruptcy, and then to secrete property from his trustee, a criminal conspiracy might appear. *Cohen v. U. S. (C. C. A.)* 157 Fed. 651. But all that is charged is that on May 10, 1907, two months before the bankruptcy, defendants agreed to commit the acts made an offense by section 29b of the bankrupt act (Act July 1, 1898, c. 541, 30 Stat. 554 [U. S. Comp. St. 1901, p. 3433]) by advising Craber, with knowledge of his insolvency, to pack and send away from his place of business the goods aforesaid; and pursuant thereto he, for the purpose of defrauding his creditors, did so pack and send away and secrete such goods, which were received and secreted by the defendant Grodin, and that Craber afterwards became bankrupt, and a trustee was appointed, etc. There is no charge that bankruptcy was contemplated, or that the secreting of the goods was done to enable Craber to secrete the goods from a trustee to be afterwards appointed. Probably nothing more than a forced settlement with creditors or a fraudulent division of the spoils was anticipated. Certainly no crime is charged to have been either intended or committed.

It is also charged by the first and third counts that after Craber was adjudged bankrupt the defendants conspired to knowingly conceal from the trustee the aforesaid goods, and that in pursuance of the conspiracy and to effect the object thereof the defendants concealed the property from the trustee, and have at no time turned it over to him, nor has any other person done so, and that the defendants still continue to conceal such property. In other words, it is charged that defendants, after they had concealed the property, conspired to continue to conceal it, and did no act in furtherance thereof. They simply failed to act. Had they moved the property, or sold any part of it, the charge that they conspired to conceal it might possibly be sustained, although two of them could not commit the offense of concealment. But in the absence of this the indictment must be held bad and the demurrer sustained. Overt acts committed before the formation of the conspiracy are not admissible. *Wilson v. People*, 94 Ill. 299; *State v. Moberly*, 121 Mo. 604, 26 S. W. 364; *Dealy v. United States*, 152 U. S. 539, 14 Sup. Ct. 680, 38 L. Ed. 545. In the *Cohen Case*, *supra*, the significance of negative acts of concealment is discussed with reference to their unlawfulness per se; but in that case numerous positive acts, committed after the conspiracy, were stated in the indictment.

UNITED STATES v. BOLOGNESI et al.

(Circuit Court, S. D. New York. August 18, 1908.)

POST OFFICE—MONEY ORDERS—LIABILITY OF RECIPIENT.

Whoever deals with an agent of the United States must assure himself of the agent's authority, and one in whose favor a postmaster or postal clerk issues a money order, without first receiving an application and payment therefor as required by law, is liable to the United States for its value, although he may have paid such agent in good faith in other ways the full value of the order.

On Demurrer to Answer.

Felix Frankfurter, for the United States.
Mayer & Gilbert, for defendants.

WARD, Circuit Judge. The United States seeks to recover from the defendants the amount of postal money orders fraudulently issued by one Marone, the clerk in charge of station 102 of the Brooklyn post office, to them as payees; Marone not having first received any applications or payments therefor, as required by the statutes of the United States and the regulations of the Post Office Department. The answer of the defendants contains a separate defense, which admits the foregoing facts, but alleges that they paid Marone in good faith in the regular course of business the full value of the money orders in foreign money, having no knowledge that he had fraudulently issued the same. The United States demurs to this defense as insufficient in law on the face thereof and not stating facts sufficient to constitute a defense.

It will be noticed that the defense avers no inquiry by the defendants, or any affirmative action whatever. It must, therefore, be construed as alleging only that they had no knowledge of or complicity in Marone's unfaithfulness. But the transaction set forth was so unusual as to require active inquiry on their part as to Marone's authority. An agent of the government was giving to them its promises to pay, executed by him, in settlement of his individual debts. On what theory could they have supposed that he would prefer to pay the United States for money orders in their favor, rather than to pay them in cash? The defense states what was done, and even in an action between individuals on a negotiable instrument, if such a state of facts were proved at the trial, it would be the duty of the court to direct a verdict for the plaintiff. *Rochester & Charlotte Company v. Paviour*, 164 N. Y. 281, 58 N. E. 114, 52 L. R. A. 790; *West St. Louis Savings Bank v. Shawnee Company*, 95 U. S. 557, 24 L. Ed. 490.

But the government stands in a more favorable position as to the actions of its agents than does an ordinary principal. Whoever deals with its agent must assure himself of the agent's authority. This arises out of public policy, protecting it against the tremendous responsibilities that might be imposed on it by faithless agents, whom it cannot oversee as individuals can oversee their agents. Judge Brewer discusses this subject in *United States v. Stockgrowers' Na-*

tional Bank (C. C.) 30 Fed. 912, in relation to post office money orders. It is true that he holds them to be nonnegotiable, but what he says in this regard is as true of negotiable instruments. A bona fide holder of a government negotiable instrument is not protected against want of authority of its agent to execute it. The Floyd Acceptances, 7 Wall. 666, 19 L. Ed. 169. In that case bona fide holders without notice of acceptances of the Secretary of War were held not entitled to recover against the government because of his want of authority to accept.

Section 4030, Rev. St. U. S. (U. S. Comp. St. 1901, p. 2742), makes any postmaster who issues a money order without first having received the money therefor guilty of a misdemeanor. This is notice of the limitation of his authority. Besides, the defendants admit in the defense demurred to that Marone's authority was to issue money orders "upon properly prepared application therefor and upon previous receipt of proper sums of money therefor," and that he "fraudulently neglected and failed to so comply with the laws and regulations governing the issuance of money orders, and appropriated to his own use the moneys paid him in good faith by the defendants, as above set forth."

But the defendants contend that the government, in issuing money orders, has entered into the domain of commerce, and therefore, under the Case of Cooke, 91 U. S. 389, 23 L. Ed. 237, is bound in respect to the money orders exactly as an individual would be. In the Cooke Case the subject of inquiry was the government's own negotiable notes issued to raise money. The transaction was purely commercial, and it was held that if the notes in question were genuine—that is, had been properly executed by authorized officers—they would be good in the hands of bona fide holders, even if wrongfully issued by government officials. This does not apply to the money orders under consideration, which were not genuine in this sense at all, because Marone had no authority to execute them.

Besides, I think that the money order system is not a business in a commercial sense, but a branch of the governmental function of carrying mails. It does not contemplate borrowing money for the benefit of the government, and is not carried on for a profit, but solely for the convenience of the public, to enable credits, not exceeding \$100, to be transmitted through the mails instead of inclosing money, for loss of which the government would not be responsible.

The demurrer is sustained.

LYNCH, Collector, v. UNION TRUST CO. OF SAN FRANCISCO et al.

(Circuit Court of Appeals, Ninth Circuit. October 5, 1908.)

No. 1,507.

1. STATUTES—RULES OF CONSTRUCTION—STATUTES IMPOSING SPECIAL TAXES.

In the construction of statutes imposing taxes, and especially burdens of special or unusual nature, in cases of doubt or ambiguity, every intendment is to be taken against the taxing power.

[Ed. Note.—For cases in point, see Cent. Dig. vol. 44, Statutes, § 326.]

2. INTERNAL REVENUE—LEGACY TAXES—CONTINGENT INTERESTS—"LEGACY"—"DISTRIBUTIVE SHARE."

The right given to a beneficiary by a will to receive a stated share of the net income from the entire residuary estate of the testator, left in trust until the time fixed for its distribution, is not a "legacy" or "distributive share," within the meaning of such terms as used in War Revenue Act June 13, 1898, c. 448, § 29, 30 Stat. 464 (U. S. Comp. St. 1901, p. 2307); and, under Act June 27, 1902, c. 1160, § 3, 32 Stat. 406 (U. S. Comp. St. Supp. 1907, p. 652), which provides that no tax shall be assessed under said section 29 in respect of any contingent beneficial interest which shall not become absolutely vested in possession or enjoyment prior to July 1, 1902, the only interest of the legatee in such income which was subject to taxation was the amount thereof actually received by him prior to said July 1, 1902, provided such amount was \$10,000 or more.

[Ed. Note.—For other definitions, see Words and Phrases, vol. 3, pp. 2135-2136; vol. 5, pp. 4054-4057; vol. 8, p. 7703.]

3. SAME—"ACTUAL VALUE"—"CLEAR VALUE."

The terms "actual value," as used in section 29, and "clear value," in section 30, War Revenue Act June 13, 1898, c. 448, 30 Stat. 464, 465 (U. S. Comp. St. 1901, pp. 2307, 2308), considered, and held to convey the idea of definite or certain value, something in no sense speculative.

[Ed. Note.—For other definitions, see Words and Phrases, vol. 1, p. 171; vol. 2, p. 1222.]

In Error to the Circuit Court of the United States for the Northern District of California.

For opinion below, see 148 Fed. 49.

This is an action to recover from the government the amount of certain taxes imposed and collected by it under the supposed sanction of Act June 13, 1898, c. 448, 30 Stat. 464 (U. S. Comp. St. 1901, p. 2286), entitled "An act to provide ways and means to meet war expenditures and for other purposes," commonly referred to as the "War Revenue Act." The material facts upon which the action arises are these:

Richard H. Follis, a resident of the city and county of San Francisco, died May 31, 1900, leaving a last will whereby, after certain provisions with which we are not concerned, he left the entire residue of his estate to trustees, in trust to receive the rents, issues, and profits thereof, and, after necessary expenditures for care, maintenance, insurance, taxes, alterations, reconstruction, etc.: "(6) To pay the net proceeds of the income, rents, issues and profits of said trust quarterly, upon the first day of each and every quarter of the year equally, share and share alike, to all of my children, Margaret, James, Richard, Mary and George up to and until such time as each of them shall respectively attain to the ages following, that is to say: Until said Margaret E. Follis, now wife of Dr. De Vecchi, shall attain the age of thirty-nine years, until said James H. Follis shall attain the age of thirty-three years, until said Richard H. Follis, Jr., shall attain the age of thirty-one years, until said Mary Lilly Follis shall attain the age of twenty-nine years, and until said George Clarence Follis shall attain the age of twenty-seven years." The will then provides for the turning over to each legatee as he reaches the age designated

of the one-fifth of the corpus of the estate. The will was duly admitted to probate, and thereafter in due course the residue of the estate was distributed to the trustees named therein, under and in strict accord with the trust clause above set forth. In proper time, and prior to such distribution, the executors, as provided by said act, made to the collector of internal revenue for the district a schedule and return, showing the facts required for the purposes of assessment, from which it appeared that the value of the personal estate remaining for distribution to the trustees, after payment of all expenses, and from which the devisees in the will would each be entitled to receive one-fifth of the net income for the period prescribed in said will, was \$778,491.28. It further showed that the period during which said beneficiaries would respectively be entitled to receive such income before payment over of his or her share of the corpus was as to three of them a fraction over four years, and as to the other two a fraction over five years, and that the present worth or value of the respective rights of the legatees to receive such income during such period, as estimated by the collector in accordance with mortuary or annuity tables upon a four per cent. basis, was: Margaret E. De Vecchi, \$23,068.83; James H. Follis, \$23,778.52; Richard H. Follis, \$30,759.41; Lillian Mary Griffin, \$28,574.43; Clarence George Follis, \$29,424.53.

The rights of the devisees, as shown by such schedule, were separately assessed; the tax upon such several rights aggregating a total of \$1,349.88. This amount was subsequently paid to the collector under protest; and a proper demand that it be refunded having been thereafter denied, this action ensued to recover that sum with interest. It was stipulated by the parties, for the purpose of judgment, that the right of the legatees to receive such income was capable of a present clear valuation, and that the valuations in said schedule and return were correct clear valuations of said rights, and "that the present clear value of the rights to the beneficial enjoyment of the bequest passing to each of said legatees by reason of the said will creating said legacies, derived from said personal property, thus computed, was in each case over \$10,000." It was further stipulated "that the total amount received by each of said beneficiaries to said trust hereinbefore mentioned, as income from said trust property, on the legacies which they will ultimately receive, if they live to the date referred to in the decree of distribution, aggregated in amount prior to July 1, 1902 [the date when the repeal of the act took effect], the total sum of \$8,750 in each case, and no more, and that no other sums were due and payable from the trustees to the legatees prior to July 1, 1902."

The Circuit Court held that the tax was illegally collected, upon the ground that the rights passing to the devisees, upon which the tax was levied, were not subject to the tax, and awarded judgment in favor of the plaintiffs below, the defendants in error here, for the recovery of the amount sued for; and this judgment is now here for review.

Robert T. Devlin, U. S. Atty., and George Clark, Asst. U. S. Atty. Heller & Powers (E. S. Heller, Frank H. Powers, and Sidney M. Ehrman, of counsel), for defendants in error.

Before GILBERT and ROSS, Circuit Judges, and VAN FLEET, District Judge.

VAN FLEET, District Judge (after stating the facts as above). No question is made as to the propriety of the amount of tax paid if the interest was subject thereto; the sole question presented for consideration being whether the right or interest passing to the legatees, and upon which the tax was assessed, was of a character to subject it to the burden imposed by the act. That question, to employ the language of counsel for the government, is:

"Whether a tax may be imposed, under the provisions of the war revenue act, upon the right to receive the income from personal property left in trust for a certain period, which period terminated after the repeal of the war revenue act."

Upon this question he states his position thus:

"It is to be noted that the tax was not imposed upon moneys or personal property to be actually received by or passing into the hands of the legatees. The tax was imposed upon the right of each legatee to enjoy the income from the corpus of the trust estate, which was delivered to the trustees for the benefit of the various legatees. The property is to be managed by the trustees for the sole use and benefit of the legatees. The legatees receive the whole of the income therefrom. They are the true owners for a stated term."

And further:

"The position of the government in the case is that each of the legatees virtually received an equitable estate for a term in a portion of the trust estate."

And that:

"The action of the collector amounted to the levying of the tax upon an equitable estate for a term of years; the legal title to the term being in the trustees, but the enjoyment of the property being vested entirely in the beneficiaries."

This fairly presents the attitude of the government in the controversy, and is, perhaps, as strong a statement of the case as the facts would warrant. Was such an interest a proper subject of taxation under the act?

This inquiry is to be answered from a consideration of the provisions of the act in the light afforded by certain adjudicated cases wherein these provisions have been under review. Primarily in this connection it is necessary to keep in view a cardinal principle, to be applied generally to the interpretation of legislation whereby the government seeks to impose a duty or burden upon the property or rights of the citizen in the nature of taxation, and more especially applicable to statutes such as this, seeking to impose a burden of a special or unusual character, and that is that, in all cases of doubt or ambiguity arising on the terms of such a statute, every intendment is to be indulged against the taxing power. This principle has been aptly stated in two cases involving the application of the statute under consideration: *Eidman v. Martinez*, 184 U. S. 578, 583, 22 Sup. Ct. 515, 46 L. Ed. 697; *Disston v. McClain*, 147 Fed. 114, 116, 77 C. C. A. 340.

The feature of the act more immediately involved is found in section 29, which, so far as material to be stated, is as follows:

"That any person or persons having in charge or trust, as administrators, executors or trustees, any legacies or distributive shares arising from personal property, where the whole amount of such personal property as aforesaid shall exceed the sum of ten thousand dollars in actual value, passing, after the passage of this act, from any person possessed of such property, either by will or by the intestate laws of any state or territory, or any personal property or interest therein, transferred by deed, grant, bargain, sale, or gift, made or intended to take effect in possession or enjoyment after the death of the grantor or bargainer, to any person or persons, or to any body or bodies, politic or corporate, in trust or otherwise, shall be and hereby are, made subject to a duty or tax, to be paid to the United States, as follows," etc. Act June 13, 1898, c. 448, 30 Stat. 464 (U. S. Comp. St. 1901, p. 2307).

This section was repealed, to take effect July 1, 1902 (Act April 12, 1902, c. 500, § 7, 32 Stat. p. 97 [U. S. Comp. St. Supp. 1907, p. 649]),

but all taxes or duties imposed thereby and the amendment thereto, prior to the taking effect of the repeal, were reserved from the operation thereof. Subsequently, on June 27, 1902 (Act June 27, 1902, c. 1160, § 3, 32 Stat. 406 [U. S. Comp. St. Supp. 1907, p. 652]), Congress passed an act, commonly known as the "Refunding Act," which authorized and directed the refunding by the Secretary of the Treasury, upon proper application, of all such taxes "as may have been collected on contingent beneficial interests which shall not have become vested prior to July first, nineteen hundred and two," and provided that no tax should thereafter be assessed or imposed, under said war revenue act, "upon or in respect to any contingent beneficial interest which shall not become absolutely vested in possession or enjoyment prior to said July first, nineteen hundred and two." This was the state of the legislation at the time the present action arose.

But three cases have been cited as bearing in any wise directly upon the particular question involved. The first or leading case is that of *Vanderbilt v. Eidman*, 196 U. S. 480, 25 Sup. Ct. 331, 49 L. Ed. 563, where the act and its amendments, as affected by the provisions of the refunding act, were under consideration by the Supreme Court, and its general scope and purpose and the rules of interpretation to be applied in ascertaining its limitations were very thoroughly gone into. In that case the testator gave the residue of his estate to his executors, to hold in trust for the support, maintenance, and education of his son, to accumulate the surplus and pay such accumulation to the son at the age of 21, and thereafter to pay him the net income of the whole estate until he should arrive at the age of 30 years, when he was to be put in possession of one-half the corpus, and the net income from the remainder to be paid him thereafter until reaching the age of 35 years, when he was to receive the remaining half of the estate; and the question arose as to the power to tax under the act the rights or interests of the son under the residuary clause of the devise. It was there held that, for the purposes of the duty or tax imposed by the act on legacies or distributive shares passing by death, such rights were intended to be placed in the same category as to the limitation of possession and enjoyment as the second class of interests referred to in the act—that is, property or interests therein transferred by deed, gift, etc., to take effect after death—and that the intent of the statute was, as to both classes, to tax only interests which were actually vested in possession or enjoyment of the beneficiary, and not an interest the title to which had merely vested in a technical sense, with the possession or enjoyment remaining contingent. In that connection, after a careful review of the provisions of section 29 of the act, it is said:

"In view of the express provisions of the statute as to possession or enjoyment and beneficial interest and clear value, and of the absence of any express language exhibiting an intention to tax a mere technically vested interest in a case where the right to possession or enjoyment was subordinated to an uncertain contingency, it would, we think, be doing violence to the statute to construe it as taxing such an interest before the period when possession or enjoyment had attached; and such is the construction which has been affixed to some state statutes, the text of which lent themselves more strongly to the construction that it was the intention to subject to immediate taxation mere-

ly technical interests without regard to a present right to possess or enjoy." *Matter of Curtis*, 142 N. Y. 219, 222, 36 N. E. 887; *Matter of Roosevelt*, 143 N. Y. 120, 38 N. E. 281, 25 L. R. A. 695.

It is further said, in discussing the effect of the refunding act:

"In view of the provision for refunding, we see no escape from the conclusion that this statute was in a sense declaratory of what we hold was the true construction of the act of 1898, and which, as we have seen, had prevailed prior to the amendment of March 2, 1901, and which was only departed from by the administrative officers under a misconception of the import of that amendatory act. * * * It is, we think, incontrovertible that the taxes which the third section of the act of 1902 directs to be refunded and those which it forbids the collection of in the future are one and the same in their nature. Any other view would destroy the unity of the section and cause its provisions to produce inexplicable conflict. From this it results that the taxes which are directed in the first sentence to be refunded, because they had been wrongfully collected on contingent beneficial interests which had not become vested prior to July 1, 1902, were taxes levied on such beneficial interests as had not become vested in possession or enjoyment prior to the date named, within the intendment of the subsequent sentence. In other words, the statute provided for the refunding of taxes collected under circumstances stated, and at the same time forbade like collections in the future."

This case was followed by that of *Herold v. Shanley*, 146 Fed. 20, 76 C. C. A. 478, decided by the Circuit Court of Appeals of the Third Circuit. In that case the question presented was essentially the same as in *Vanderbilt v. Eidman*, and the decision, being rested upon the authority of that case, does not call for further comment.

It will be observed that in neither of these two cases was the precise question presented in the case at bar involved; the only question being, as above suggested, the right to tax the residuary interest passing to the legatees. The cases are valuable, however, as furnishing an authoritative declaration of the scope and purpose of the act and the rules to be observed in its application.

The case of *Disston v. McClain*, above referred to, is more nearly analogous to the present, if, indeed, it may not be said to be exactly on all fours. In that case the will of the testator gave the residue of his estate to trustees, to keep the same invested, and—

"from the income arising from all my said estate to pay first to my beloved friend, Rachael Asch, the sum of fifteen thousand dollars per year during all the term of her natural life—such payment to be made to her by them in quarterly installments of three thousand seven hundred and fifty dollars each, and the first installment to be paid to her three months after my decease and thereafter quarterly, as aforesaid."

It was sought, as in this case, to tax this legacy or income as a life estate, and for that purpose its value was attempted to be ascertained by the employment of life or annuity tables. The opinion is written by Judge Gray, and is very full and exhaustive. After adverting to the rule of strict construction above referred to, it is said, with reference to the terms of the act as bearing upon the interest of the legatee:

"In the first place, it is to be noticed that the tax is imposed in general terms upon legacies and distributive shares. These words possess a definite meaning, and no confusion or difficulty need arise as to the subjects with reference to which taxation is imposed. Legacies and distributive shares are classed together, and as a distributive share is a definite portion in money of the residue of the personal estate of an intestate, so a legacy is a definite gift by will of

personal property, either general and pecuniary, or specific. As such, a legacy is of a specific article, or of specific articles, of personal property, or of an ascertained and definite pecuniary amount, and may be readily valued by the executor or trustee having it in charge. It is the corpus to which the legatee is entitled in possession or enjoyment. The legacy in question, under the will of the testator, is not a sum certain, given once for all to the legatee, but a yearly sum of \$15,000, to be paid to Rachael Asch in stated quarterly payments during the term of her natural life out of the income of the whole estate, real and personal, of the testator, devised and bequeathed to trustees for the purposes of his will. The natural meaning of such a provision, and of the language used, would seem clearly to be a series of legacies or bequests vesting in possession or enjoyment at stated intervals, but each contingent, before vesting, on the legatee's being alive when it became due, the tax on which is not to be paid, as we shall see presently from the authoritative opinion of the Supreme Court in the *Eidman Case*, until and as it takes effect in possession or enjoyment."

And, after an elaborate discussion of the case of *Vanderbilt v. Eidman* and the principles of construction there announced, it is said:

"By confining ourselves to what the statute plainly says, and avoiding unauthorized and artificial constructions, we can find only as a subject of taxation thereunder a series of payments to be made quarterly, each contingent, as to possession and enjoyment, upon the happening of an event named in the will, to wit, that the legatee should be alive when the payments are to be made. The statute nowhere refers in express terms to the interest or income of a legacy, nor does it impose any tax in respect thereto, before it is actually received. If the act had intended that the interest in a fixed and definite income for life, payable out of the total income of the whole residuary real and personal estate, should be taxed, this intention would not be left to inference, but would be clearly expressed, and a mode of estimating such an interest would be prescribed, as, for example, has been done in the collateral inheritance tax laws of the states of New York and New Jersey. In this statute there is no mode provided for valuing such an income given to a person for life. The mode adopted by the collector in this case is entirely unauthorized by the statute, for he did not estimate by life tables the value of a life estate in a designated and ascertained fund, but by an exercise of his arbitrary judgment proceeded to ascertain or create the fund that would produce the income, though it had not been ascertained or designated by the testator, and then proceeded to value it by the use of the life tables."

Applying the principles announced in these cases to the facts here presented, it would seem to be obvious that the interest sought to be taxed under the will of *Follis* did not fall within the terms of the statute. Confessedly the only present right passing to these beneficiaries was that of receiving the income from the corpus of the estate in the hands of the trustees. Such an interest does not, for the reasons aptly stated by Judge Gray in *Disston v. McClain*, fall within the definition of either a legacy or a distributive share, in the sense in which those terms are employed in the act. It matters not that this right to the income may, as contended by counsel for the government, constitute an equitable interest in the trust fund, the present beneficial enjoyment of which is in the beneficiaries. It may, indeed, be conceded that this is a correct characterization of the estate conferred. But the question is: Does the act undertake to impose any burden upon such an interest? Very clearly it does not in express terms; and under the doctrine of strict construction, heretofore referred to, the application of those terms is not to be extended by implication beyond their plain, usual, and ordinary sense. As suggested by Judge Gray,

the act says nothing about taxing the mere right to an income before that income is actually received; and, had such been the intention, it would have been a very easy matter to express the purpose. Instead, Congress has contented itself, in designating the estates that shall be burdened with the tax, by employing terms having general and well-understood significations, and by those terms must its purpose be limited.

Moreover, as held in *Vanderbilt v. Eidman*, the purpose of the act was to subject to taxation only beneficial interests, which by reason of being absolutely vested in possession or enjoyment have a value capable of being definitely ascertained—"actual value" as expressed in section 29, or "clear value" as expressed in section 30. The estate or interest here sought to be taxed was very clearly not of that character. While the right to receive the income was vested, it was a right the enjoyment of which, as with the legatee in *Disston v. McClain*, was contingent upon the beneficiaries living to receive it; and, furthermore, as in that case, this income was to be derived from the entire residue of the estate of the testator, real and personal alike. It was necessary for the collector, therefore, under the limitations of the act, which taxes personal property alone, in order to reach his basis of value for the assessment, to first segregate the real from the personal property, and then resort, not only to the use of life or mortality tables, but to employ an arbitrarily assumed rate of interest in making the computation. We are entirely satisfied that, whether the employment of mortality or life tables under any circumstances is contemplated by the act, the mode resorted to in this case was not such as to produce the "actual" or "clear" value therein specified. In using those terms Congress must be deemed to have meant something more definite and certain than would be attached to the bald term "value," without the qualifying adjectives. A thing may have value in a general sense, although that value may not be susceptible of ready or definite ascertainment. It may depend upon some uncertainty or contingency. So that, when Congress employed the expressions "actual value" and "clear value," it very evidently intended to convey the idea of definite or certain value—something in no sense speculative. Here it is at once apparent that the result reached as a basis for the tax through the method adopted was at most an approximation or merely speculative; and it could be nothing else. Life or annuity tables are never employed to ascertain definite or actual results, but only as guides to a reasonable approximation. *Vicksburg, etc., R. R. Co. v. Putnam*, 118 U. S. 545, 7 Sup. Ct. 1, 30 L. Ed. 257, and cases there cited.

We have not overlooked in this connection the stipulation in the record on the subject of value; but we do not read that stipulation as meaning anything more than that the result reached was the admitted value of the interests as that value was shown by the method of computation adopted—not that the employment of such a method was authorized by the act. If it was intended by the stipulation to convey the latter idea, it must be disregarded, since the parties can-

not be permitted to bind the court as to the proper construction of the statute.

Without pursuing the analogies further, we are satisfied that in no essential particular are the rights of the legatees involved in this case to be distinguished in their legal aspects from those involved in *Disston v. McClain*, and that, in accord with the conclusion reached in that case, it must be held that the only interest these legatees received under the will of the testator which could properly have been subjected to taxation under the act in question was the amount of income actually received and enjoyed prior to the date when the repeal of the act took effect; and, as that sum as to no one of them reached the amount of \$10,000, there was nothing to which the tax could attach.

The contention of the government that the right to tax such an interest was implicitly upheld by the Supreme Court in *Vanderbilt v. Eidman* is very fully met and refuted in *Disston v. McClain*, and need not be further noticed.

These considerations are conclusive of the propriety of the judgment of the Circuit Court, and it is accordingly affirmed.

MILLS v. VIRGINIA-CAROLINA LUMBER CO.

(Circuit Court of Appeals. Fourth Circuit. July 24, 1908.)

No. 734.

1. BANKRUPTCY—PREFERENCE—DELIVERY OF PROPERTY UNDER CONTRACT OF SALE.

Where a bankrupt, who operated a lumber mill, made a contract for the sale of the entire output of his mill and secured from the purchaser advance payments thereon, the purchaser, by insisting on and obtaining delivery of sufficient lumber which was then on hand to cover the advances within four months prior to the bankruptcy and when the seller was insolvent, did not thereby secure a preference as a creditor which it was required to surrender before proving a secured debt against the estate.

2. SAME—SECURED CREDITOR—LIABILITY FOR GENERAL COSTS.

A mortgage creditor of a bankrupt, who proves his claim solely for the purpose of enforcing his lien on the proceeds of the mortgaged property, which has been sold by the trustee, does not thereby become liable for his proportionate share of the costs of the general administration of the estate.

[Ed. Note.—For cases in point, see Cent. Dig. vol. 6, Bankruptcy, § 882.]

Appeal from the District Court of the United States for the Eastern District of North Carolina, at Raleigh, in Bankruptcy.

Addison L. Holladay (R. N. Simms, on the brief), for appellant.
James H. Pou and G. E. Caskie (Caskie & Coleman, on the brief), for appellee.

Before PRITCHARD, Circuit Judge, and WADDILL and BOYD, District Judges.

BOYD, District Judge. This is an appeal from an order of the District Court of the United States for the Eastern District of North Carolina, sitting in bankruptcy, made in the matter of J. R. Franklin, bankrupt, allowing the Virginia-Carolina Lumber Company to prove a debt against the estate of the said bankrupt amounting to the sum of \$750 and interest, the payment of which said debt was secured by deed in trust executed by Franklin to the said Virginia-Carolina Lumber Company within four months preceding the adjudication in bankruptcy. John A. Mills, the trustee of the bankrupt, filed objections to the proof of this debt on the ground that shortly before the adjudication in bankruptcy the Virginia-Carolina Lumber Company had received a preference in the distribution of the bankrupt's estate by taking into its possession \$1,000 worth of lumber, property of the bankrupt, and applying it to the payment of another debt which the said lumber company held, or claimed to hold, against Franklin.

The facts, in substance, are these: J. R. Franklin was a manufacturer of lumber, engaged in operating a planing mill in the Eastern district of North Carolina. On the 4th day of January, 1905, Franklin borrowed from the Virginia-Carolina Lumber Company, of Lynchburg, Va., \$750 in cash and executed therefor two notes, each for \$375, and each bearing that date, the one payable at four months and the other at six months, and at the time of the said loan the said Franklin executed to one Henry M. Sackett, as trustee, a deed in trust conveying certain of his property to secure the payment of the two said notes. On the 8th day of February, 1905, following the date of the loan, the said lumber company and the said Franklin entered into an agreement by which the former agreed to purchase from the latter and the latter agreed to sell to the former the entire output of Franklin's planing mill at certain prices, which were set forth in the agreement and which was in writing; the lumber to be delivered free on board cars at Chalybeat Springs, N. C., where the planing mill was located. The terms of payment for the lumber under this agreement were that the lumber company was to pay 80 per cent. on each shipment, upon receipt of the invoice therefor accompanied by bill of lading, and the remaining 20 per cent., less 2 per cent. discount on the entire bill for cash, when the shipment was received and accepted by the purchaser. During the month of February following the contract of purchase the lumber company advanced thereon to Franklin various sums of money, amounting in the aggregate to \$950. This amount was advanced on open account under the contract for the output of the mill, and the lumber company held no security therefor. Franklin filed his voluntary petition and was adjudged bankrupt upon the 10th of March, 1905, and a few days prior thereto the president and another officer of the lumber company called upon Franklin and discussed with him the status of his business and his financial affairs. At this time Franklin stated to them that he was insolvent. Thereupon the lumber company, through these officers, demanded of Franklin the delivery to the company of about \$1,000 worth of lumber, then upon the millyard, which had been manufactured by the planing mill, and which Franklin, after some hesitation, delivered to them. After this, on the 21st of September, 1905, the lumber company filed with the

referee its proof of debt of the \$750 hereinbefore referred to, together with the deed in trust upon the property of Franklin, executed as security therefor. The trustee in bankruptcy objected to the proof of this claim, and an allowance therefor in the distribution of the estate of the bankrupt, on the ground that within a few days before the adjudication the said lumber company had obtained from Franklin a transfer of \$1,000 worth of lumber, and had seized and taken away the said lumber belonging to Franklin, in order to enable the said lumber company to obtain a greater percentage of its debt against said Franklin than other creditors of the same class would obtain. It may be further stated that in the meantime the trustee of Franklin's estate in bankruptcy had proceeded, without notice to Sackett, the trustee, or to the lumber company, the cestui que trust, and had sold the property conveyed in the trust, which brought something over \$700; the proceeds being still in the hands of the trustee.

The order of the bankrupt court was to the effect that by reason of the taking of the \$1,000 worth of lumber, under the circumstances detailed, the lumber company had not secured a preference in the distribution of the bankrupt's estate, such as contemplated by the bankruptcy law, that would have the effect to defeat the right of the company to prove its \$750 debt for money loaned and to assert its right to the proceeds of the property which had been conveyed in the deed in trust as security for the payment of said loan. We are of the opinion that there was no error in this ruling. The \$750 debt was for a present loan, and the mortgage upon the property of Franklin, who was afterwards adjudged bankrupt, was given at the time of the loan to secure its payment. It is therefore not affected by the adjudication within the four months from the date of the transaction. In fact, there is no controversy, so far as this record shows, about that proposition, the sole question being that raised by the trustee in his objection to the proof of the \$750 debt against the estate of the bankrupt; the objection being that by reason of an alleged preference secured as to another debt by taking the \$1,000 worth of lumber a few days before the adjudication the lumber company had deprived itself of the right to prove the \$750 debt. In our opinion, the transaction in which the lumber was taken does not constitute an advantage in the distribution of the bankrupt's estate, such as to create a preference under the bankruptcy laws.

There was no suggestion that the contract made between the lumber company and Franklin for the purchase of the entire output of Franklin's mill was not a fair one, and one that the law would enforce. The contract was still existing at the time of the adjudication, and whatever lumber was on hand as the product of the mill the lumber company had a right to claim, provided it complied with the terms which had been agreed upon. If there had been no payment upon the contract of purchase in advance, the lumber company would have been entitled to require the trustee to surrender to it the lumber produced at the mill, provided it complied with the terms of purchase. Having advanced money upon the contract of purchase, the lumber company thereby became entitled to at least as much of the product of the mill as it had paid for, and it could have recovered so much from the trus-

tee, even after the bankruptcy. It is our opinion that, at most, the taking of the \$1,000 worth of lumber under a claim by the lumber company that it was entitled to that specific property by virtue of the contract of purchase cannot be construed into a payment upon an existing debt, such as to constitute a preference under the bankruptcy law. If the trustee shall conclude that the \$1,000 worth of lumber was wrongfully taken by the lumber company, he has his right of action either to the recovery of the lumber or the value of it, and this right he is entitled to assert in the proper court whenever he elects to do so; our decision only going to the extent of determining that the transaction about the lumber does not operate to estop the lumber company from proving the \$750 debt, with the security which had been given therefor.

While we think, therefore, that the judgment of the District Court, allowing the proof of the \$750 debt, should be affirmed, we feel constrained to modify the judgment with respect to cost. In the order which was filed by the District Court from the report of the referee, we find the following:

"It is further ordered and adjudged that, as the creditor (meaning the Virginia-Carolina Lumber Company) voluntarily came into court and filed its claim for allowance, said claim must bear its pro rata part of the costs of the administration under the proceedings in bankruptcy."

Aside from the mere costs incident to the proof of the claim, we do not see how this creditor should be required to pay any part of the costs of the administration of this bankrupt's estate. The lumber company had its claim secured by deed in trust on the property of the bankrupt, and it was entitled to have its claim paid in full, provided the property so conveyed would bring enough. The trustee in bankruptcy elected to sell this property and has the proceeds of the sale in hand. The lumber company, in our opinion, is entitled to have of the proceeds of the sale sufficient to pay its debt and interest, provided there is enough. If the property did not bring enough to pay the debt and interest in full, then the lumber company is entitled to have the whole of the proceeds. In other words, this creditor, which has simply come into a bankrupt court and established a debt that is a lien upon specific property of the bankrupt, should not be charged, so as to reduce the security, by making the fund arising from such specific property liable for the costs of the general administration of the bankrupt's estate. With this modification, the judgment of the District Court for the Eastern District of North Carolina, sitting in bankruptcy, is affirmed.

Affirmed.

NOTE.—The following is the opinion of Purnell, District Judge, affirming the opinion of the referee:

PURNELL, District Judge. Claim of the Virginia-Carolina Lumber Company. The allowance of this claim was objected to by the trustee, and after hearing the matter fully the referee finds the following facts, which are certified in due form, to wit:

"(1) J. R. Franklin was duly adjudicated a bankrupt on March 10, 1905, upon the petition filed March 6, 1905.

"(2) On the 4th day of January, 1905, prior to the filing of the petition in bankruptcy, the bankrupt obtained from the Virginia-Carolina Lumber Company a promise to advance the sum of \$750 with which to buy a certain tract of timber known as the 'Pearson timber tract,' and in the transaction promised to give the Virginia-Carolina Lumber Company a mortgage upon said timber to secure the said loan. On January 4, 1905, the Virginia-Carolina Lumber Company advanced the money to the bankrupt, and on the same day he executed to the said company two notes, of \$375 each, secured by deed of trust of even date, conveying to the said Virginia-Carolina Lumber Company the identical timber rights for which the purchase money had been advanced. Although the bankrupt had signed the deed of trust on January 4, 1905, he did not acknowledge the same until January 14th, 10 days after the signing of the same, and the said deed of trust was not registered in Harnett county until January 16, 1905, 12 days after the same was signed.

"(3) It appears from the evidence, and is found as a fact, that the bankrupt used \$400 of the money so advanced by the Virginia-Carolina Lumber Company in paying for said timber rights, and that the balance, \$350, the bankrupt put to his own personal use in his business, but that 10 or 15 days after the receipt of the money from the Virginia-Carolina Lumber Company the bankrupt paid the balance due on the said timber rights to the vendors, J. D. and W. M. Pearson.

"(4) The timber rights described in the deed of trust to the Virginia-Carolina Lumber Company and as set out in its proof of claim, is the identical tract of timber which the said lumber company advanced the money to the bankrupt to buy, and said timber rights, under the adjudication in bankruptcy, passed into the possession of the trustee of bankrupt, and was sold by him, and the proceeds arising from said sale are now in the possession of the said trustee, subject to the orders of court, under the proof of claim filed thereto.

"(5) During the month of February following the execution of the deed of trust in January, the bankrupt entered into a contract with the Virginia-Carolina Lumber Company to sell to the said lumber company the entire output of his sawmill, which contract is filed as an exhibit in this proceeding, and upon this contract the bankrupt obtained during the month of February from the Virginia-Carolina Lumber Company advances in money amounting to \$950. The amount so advanced was advanced on open account under the contract for the output of the mill, and the Virginia-Carolina Lumber Company held no security therefor. Within a week before the bankrupt filed his petition in bankruptcy the president and another officer of the Virginia-Carolina Lumber Company came to the city of Raleigh, as appears from the evidence, and discussed the status of the bankrupt's business with him fully. At that time the bankrupt was insolvent, and was aware of this fact, and so informed the said officers of the Virginia-Carolina Lumber Company. He further swears, as appears in the evidence, that he told the said officers of the company that his creditors were pressing him and that he must have money, or he would have to suspend operation of his sawmill plant. Thereupon the said officers of the said Virginia-Carolina Lumber Company refused to advance to said bankrupt any more money and demanded that he surrender to them the lumber he had on hand, and the bankrupt swears that upon his hesitating to do so said officers of the lumber company threatened him, and by such threats obtained from him his consent to the removal of a large quantity of lumber, then in possession of the said bankrupt, at Chalybeate Springs, N. C. After obtaining the consent from the bankrupt, the said Virginia-Carolina Lumber Company thereupon seized and took possession of and carried away and converted to its own use a large amount of lumber, of the value of about \$1,000, belonging to the said bankrupt, and that in so doing the said Virginia-Carolina Lumber Company obtained a greater percentage of its claim against said J. R. Franklin than the other creditors of the same class; that at the time this preference was obtained upon the unsecured claim against the bankrupt the said Virginia-Carolina Lumber Company not only had reasonable cause to know, but did know, as appears from the evidence, that Franklin was insolvent, and that the said transfer and seizure of said lumber were made in contemplation of the bankruptcy of the said Franklin, and the transfer of the said lumber to the Virginia-Carolina Lumber Company was done, and in fact

It appears from the evidence it was done, in fraud of the other creditors of said bankrupt, other than the said Virginia-Carolina Lumber Company, and that the said transfer of the property by the bankrupt to the said Virginia-Carolina Lumber Company was under duress of the threats made to the bankrupt by the said Virginia-Carolina Lumber Company; that said property was seized and obtained by the Virginia-Carolina Lumber Company within four months of the filing of the petition in bankruptcy—in fact, within one week prior to the filing by the bankrupt of his petition in bankruptcy; that after said property had been so seized and carried away by the said Virginia-Carolina Lumber Company and converted to its own use said Franklin repeatedly demanded statements from them as to the amount of the said lumber carried away, but said Virginia-Carolina Lumber Company refused to furnish same; that similar demands were made upon them by the trustee in bankruptcy after his appointment, and these demands were also refused. Said Virginia-Carolina Lumber Company has filed no proof of claim upon this transaction with the bankrupt, and has not surrendered or made any account or payment to the trustee in bankruptcy on account of the said lumber transferred to and seized by it from the bankrupt, to the value of about \$1,000.

“(6) The said Virginia-Carolina Lumber Company has voluntarily come into this court and proven its claim for the \$750 and interest, the same being money advanced for the purchase of the Pearson timber tract, claiming its right to receive the proceeds of the sale of this tract by the trustee in bankruptcy.

“From the foregoing facts the referee is of the opinion that the secured claim of the Virginia-Carolina Lumber Company should be allowed, and the same is allowed; and it is adjudged that the said creditor is entitled to be paid the sum of \$750 and interest on said claim from January 4, 1905, until paid, out of the proceeds of the sale, now in the hands of the trustee, arising from the sale of the securities mentioned in the deed of trust, provided the amount realized from the sale of said securities is sufficient to meet the principal and interest. It is further ordered and adjudged that, as the creditor voluntarily came into court and filed its claim for allowance, the said claim must bear its pro rata part of the cost of administration under the proceedings in bankruptcy. The referee is of the further opinion that the transaction under the deed of trust and under the contract for the purchase of the output of the bankrupt's sawmill plant are two separate and distinct transactions; the one under the deed of trust being a security given for a present consideration, and the other being wherein money was advanced on open account to the bankrupt under a contract to purchase the output of the mill, no security being given.

“In considering the rights of the creditor, to wit, the Virginia-Carolina Lumber Company, the referee is of the opinion that the validity of its secured claim cannot be attacked for invalidity on account of the fraudulent preference, which was knowingly obtained by the said creditor in trying to make itself secure against loss on its unsecured claim, which was for money advanced under the contract for the purchase of the output of the sawmill. The two transactions are separate and distinct. If the creditor should attempt to prove its claim for the money advanced under the contract, it could not be allowed until it should surrender to the trustee the preferential payment, to wit, the value of the lumber, which it knowingly and fraudulently obtained as a payment from the bankrupt on the very eve of the filing of the petition in bankruptcy. The referee is of the opinion that the proper course to be pursued by the trustee in obtaining from the Virginia-Carolina Lumber Company the preferential payment made to it by the bankrupt as herein stated would be by suit entered against the said lumber company in the District Court of Virginia.”

The report of the referee, the cleverness with which he finds the facts and states his conclusions of law, is highly commendable. While he does not pretend to cite all the decisions upon which his conclusions are based, he does cite ample to show such conclusions are sound, and his decision on this claim is in all respects affirmed.

The second debt was contracted for the purchase of the property set aside and appropriated under the mortgage for the payment thereof. This class of

debts is of a high order, and under the state Constitution (article 10, § 2), exempting from sale under execution the homestead of a debtor, it is provided, "But no property shall be exempted from sale for taxes or for payment of obligations contracted for the purchase of said premises," thus providing for what may be termed a constitutional mortgage or lien for purchase money. The debt allowed was purchase money, and the especial property appropriated for the payment of the debt seems to be a proper contract, in compliance with the constitutional provision referred to. The trustee could acquire no better title than the bankrupt had; he succeeds to the bankrupt's title—no more, and no less; and he takes subject to liens good against the bankrupt at the time. This is well settled, and the receipt of a preference on a separate and distinct transaction could not divest a creditor of his vested rights to the property or the proceeds thereof.

Exceptions to the allowance of this claim are overruled, and the report of the referee, both as to findings of fact and conclusions of law, affirmed.

ROBINSON et al. v. DENVER CITY TRAMWAY CO.

(Circuit Court of Appeals, Eighth Circuit. September 5, 1908.)

No. 2,601.

1. MASTER AND SERVANT—EVIDENCE—ACTION FOR NEGLIGENCE OF SERVANT—PRIOR CONDUCT.

In an action against an employer, where the sole charge is that an employé was negligent on a particular occasion, it is irrelevant to prove that he, or some other employé, had been negligent on other occasions.

2. SAME—MUNICIPAL ORDINANCE NOT AVAILABLE UNLESS PLEADED.

A municipal ordinance is not a public statute, but a mere municipal regulation, and to make it available in establishing a charge of negligence it must be pleaded, like any other fact of which judicial notice will not be taken.

3. APPEAL AND ERROR—ERRONEOUS CHARGE NO GROUND FOR REVERSAL, IF WITHOUT PREJUDICE.

Whilst questions of fact may not be retried on a writ of error, errors in the charge to the jury may be disregarded, if, upon all the evidence properly admitted, a verdict in favor of the unsuccessful party could not lawfully be sustained, and there be no erroneous exclusion of evidence offered by him.

4. TRIAL—QUESTION FOR COURT OR JURY—DIRECTION OF VERDICT.

When the evidence is undisputed, or is so clearly preponderant that the court, in the exercise of a sound judicial discretion, could give effect to but one verdict, the case may, and should, be withdrawn from the jury, and their verdict directed.

(Syllabus by the Court.)

In Error to the Circuit Court of the United States for the District of Colorado.

Sterling B. Toney (Henry V. Johnson and R. Burge Toney, on the brief), for plaintiffs in error.

Howard S. Robertson (Charles J. Hughes, Jr., and Gerald Hughes, on the brief), for defendant in error.

Before SANBORN and VAN DEVANTER, Circuit Judges, and PHILIPS, District Judge.

VAN DEVANTER, Circuit Judge. Mary A. Robinson, a passenger upon a street car, sustained fatal injuries when alighting or

preparing to alight therefrom while it was in motion, and her heirs brought an action against the street car company to recover for her death, alleging that it was caused by the negligence of the company's servants. The injuries were sustained in the city of Denver, at the intersection of Twelfth avenue and Steele streets, where the company maintains a Y upon which to turn its cars; that being the end of one of its lines of railway. The main track is in Twelfth avenue, and the Y is in Steele street. Outbound cars, on reaching the Y, pass around its first arm to a stopping place on its stem, and then move backward around the second arm to another stopping place on the main track. In that way they are completely turned preparatory to making the return trip across Steele street and along Twelfth avenue. The two stopping places are a little more than 100 feet apart, and passengers are permitted to leave and enter at both. The cars have an inclosed section and an open one; the former being in front. At the side of the open section, near the middle of the car, is an open doorway, with a step or footboard below it, and in the center of the doorway is an upright post or bar, which passengers can grasp to assist themselves in entering and leaving. Mrs. Robinson was in the inclosed section of an outbound car which reached Steele street in the evening shortly after it became dark. The car passed around the first arm of the Y and stopped on the stem for a brief interval, as it had to do, so that the switch might be thrown and the movement of the car reversed. It then moved backward around the second arm of the Y, and as it passed the middle of the curve Mrs. Robinson fell to the ground in front of the doorway in the side of the open section. One of her legs passed under the car and was crushed by the wheels; death resulting therefrom in a few days. Before the stop on the stem of the Y she gave no signal and made no request indicative of a purpose to leave the car at that place. She had used that car line many times before, had entered and left the cars at both stopping places, was familiar with the surroundings, was of mature years and in full possession of her faculties, and was carrying nothing more cumbersome than a small hand bag.

Thus far the facts were conceded, and so the controlling question was: How did she come to fall at the side of the moving car as it passed around the curve in the second arm of the Y? The complaint charged that when the car stopped on the stem of the Y she arose from her seat in the inclosed section and advanced to the open section, intending to alight therefrom; that as she stepped into the open section the car suddenly moved backward toward the other end of the second arm; that she took hold of the upright post or bar at the doorway in the side of the car; and that, while she was holding to this post or bar and "waiting for the car to stop" at the other stopping place, which "was but a few yards" away, the motorman or conductor "carelessly, recklessly, and negligently backed" the car around the curve "at such a reckless, violent, and rapid rate" as to break her hold on the upright post or bar, "and threw her" through the open doorway "with great violence." The answer denied what was so charged, and alleged that her injuries were due to contributory negligence on

her part, without which they would not have been sustained. The issues so presented, with such evidence as was admitted in that connection, were submitted to the jury, and they returned a verdict for the defendant, which the court declined to disturb on a motion for a new trial.

A reversal of the judgment is now sought because of rulings whereby evidence was excluded, and because of alleged errors in the charge to the jury. As some of the former were not excepted to, they must be held to have been acquiesced in. *Newport News, etc., Co. v. Pace*, 158 U. S. 36, 15 Sup. Ct. 743, 39 L. Ed. 887; *Stewart v. Wyoming Ranch Co.*, 128 U. S. 383, 390, 9 Sup. Ct. 101, 32 L. Ed. 439; *Rodriguez v. United States*, 198 U. S. 156, 165, 25 Sup. Ct. 617, 49 L. Ed. 994.

One ruling to which an exception was reserved was the rejection of an offer to prove by a woman living in that locality that on other occasions she had seen cars move around the same curve "at a very rapid rate." The ruling was right. The offer fell within the rule that in an action against an employer, where the sole charge is that an employé was negligent on a particular occasion, it is irrelevant to prove that he, or some other employé, had been negligent on other occasions. 1 *Wharton Ev.* (3d Ed.) § 40; *Maguire v. Middlesex R. Co.*, 115 Mass. 239; *Harriman v. Pullman Palace Car Co.*, 29 C. C. A. 194, 85 Fed. 353; *Delaware, etc., Co. v. Converse*, 139 U. S. 469, 476, 11 Sup. Ct. 569, 35 L. Ed. 213; *Louisville, etc., Co. v. McClish*, 53 C. C. A. 60, 68, 115 Fed. 268, 276; *Pueblo Building Co. v. Klein*, 5 Colo. App. 348, 38 Pac. 608.

Another ruling to which an exception was taken was the exclusion of a purported ordinance of the city laying certain duties upon the defendant which it was said were violated on this occasion. This ruling was also right. An ordinance is not a public statute, but a mere municipal regulation; and, to make it available in establishing a charge of negligence, it must be pleaded, like any other fact of which judicial notice will not be taken. Here it was not pleaded, and so could not be proven. *City of Greeley v. Hamman*, 12 Colo. 94, 96, 20 Pac. 1; *Weiss-Chapman Drug Co. v. People*, 39 Colo. 374, 378, 89 Pac. 778; *Fay v. City of Ft. Collins*, 40 Colo. 262, 90 Pac. 512; *Garlich v. Northern Pac. Ry. Co.*, 67 C. C. A. 237, 131 Fed. 837; *Horn v. Chicago, etc., Co.*, 38 Wis. 463; *Watt v. Jones*, 60 Kan. 201, 56 Pac. 16; *Austin v. Walton*, 68 Tex. 507, 5 S. W. 70; *Illinois Cent. R. Co. v. Ashline*, 171 Ill. 313, 49 N. E. 521; *Gardner v. Detroit St. Rv. Co.*, 99 Mich. 182, 58 N. W. 49; 4 *Elliott on Railroads* (2d Ed.) § 1698; 6 *Thompson on Negligence* (2d Ed.) § 7470; 28 *Cyc.* 393. And it may be observed in passing that the terms of the ordinance were such that its application to the case was at least very questionable.

The objections to portions of the charge to the jury are earnestly and forcefully pressed upon us, but it will not be necessary to consider them, if, as is contended by the defendant, the verdict was right as matter of law; for, whilst we may not retry the questions of fact, we may disregard any errors in the charge, there being no erroneous exclusion of evidence offered by the plaintiffs, if, upon all the evidence properly admitted, a verdict in their favor could not lawfully

have been sustained. In such cases we but apply the familiar rule that errors which could not have prejudiced the unsuccessful party give no right to a reversal. *Cook v. Foley*, 81 C. C. A. 237, 152 Fed. 41; *Ætna Indemnity Co. v. Coal Co.*, 83 C. C. A. 431, 154 Fed. 545; *Brobst v. Brock*, 10 Wall. 519, 18 L. Ed. 387; *McLemore v. Louisiana State Bank*, 91 U. S. 27, 23 L. Ed. 196; *West v. Cambden*, 135 U. S. 507, 10 Sup. Ct. 838, 34 L. Ed. 254.

We turn, then, to the evidence to ascertain whether that bearing on the issues of fact before stated, particularly the alleged actionable negligence of the defendant, was such that a verdict for the plaintiffs could not lawfully have been sustained; or, putting it in another way, whether the evidence which made against the plaintiffs was undisputed, or so clearly preponderant that the Circuit Court, in the exercise of a sound judicial discretion, should have withdrawn the case from the jury and directed a verdict for the defendant. If so, that court rightly declined to disturb the verdict on the motion for a new trial, and we should decline to disturb it now. *Patton v. Texas & Pacific Ry. Co.*, 179 U. S. 658, 21 Sup. Ct. 275, 45 L. Ed. 361; *Commissioners v. Clark*, 94 U. S. 278, 284, 24 L. Ed. 59; *Southern Pacific Co. v. Pool*, 160 U. S. 438, 16 Sup. Ct. 338, 40 L. Ed. 485; *Patillo v. Allen-West Co.*, 65 C. C. A. 508, 131 Fed. 680; *Swift & Co. v. Johnson*, 71 C. C. A. 619, 626, 138 Fed. 867, 874, 1 L. R. A. (N. S.) 1161.

In addition to the conceded facts before stated, there was this evidence: Euphemia I. Haskill, a married daughter of Mrs. Robinson, was the only one of plaintiffs' witnesses having any personal knowledge of the accident. She had gone to the car line to meet her mother, and was in Steele street near the front end of the car when it stopped on the stem of the Y. She testified that "just as the car was making its stop" her mother rose from a seat in the inclosed section and walked to the open section, "but before she got to" the side doorway the car began its backward movement; that she then took hold of the upright bar with her left hand, having her hand bag in the other; that she was still in that position when the doorway, which was on the same side of the car as the witness, passed out of sight around the curve; that the witness was near enough to have spoken to her mother when the latter was at the doorway, but she did not do so, and she thinks her mother did not see her; that "the car backed very swiftly" and "was going very rapidly"; that as the car moved backward the conductor was at the rear end of it, facing in the direction it was moving; that the witness followed the car, and when she found her mother at the side of the track in an injured condition the latter said, "Oh! why did they not stop that car, and why did they go around there so fast?" Two of her answers given on cross-examination were somewhat confusing in the light of her other testimony. They were:

"Q. Had your mother started to arise before the car started back? A. No."

And also:

"Q. Where was the car when you saw your mother step out from the inclosed car into the open portion? A. It was where it should stop, had it stopped on Steele street."

She did not know, and therefore did not say, how her mother came to fall; nor did she describe her mother's attitude in holding to the upright bar as that of one who was having some difficulty in maintaining her hold. And it is of some significance in that connection that there was a seat immediately at the mother's right which she could have taken, if there was occasion to do so.

Upon the part of the defendant there were three witnesses having some personal knowledge of the accident. One, the motorman, could not see what took place in the car, because of the curtains at the front end of the inclosed section; but he testified that the stop on the stem of the Y was of short duration, about 10 or 15 seconds, that he then received a bell signal to back the car, and that he gave it "just one point," which he explained in this way:

"One point is the first point to start her; that is, you get half the current with all the resistance in the car, and she starts very slow on one point. There are nine points altogether on the switch. The first point starts very easy, the second point gives a little more, and so on up to nine, until you get full speed."

He further said that the maximum speed attained in rounding the curve could not have been more than three or four miles an hour, and that he stopped the car promptly and readily when he realized that an accident had occurred. Another witness, the conductor, testified that the car came to a full stop on the stem of the Y; that there were then three passengers on the car, all being in the inclosed section; that he looked into that section, and none of them gave any indication of a purpose to leave the car there, all remaining in their seats; that he then signaled to the motorman to back the car, and himself took a position at the rear end of it, facing in the direction of its movement, as it was his duty to do; that the car moved "about as fast as a man or a horse would walk," or about three or four miles an hour; and that about half way around the curve he heard a scream, and, on running to the doorway and alighting, he found Mrs. Robinson lying at the side of the track near the front end of the car. The third witness, Miss Baumgartner, was a passenger, and had the best opportunity of knowing what actually occurred, because she was sitting in the inclosed section, near the door leading to the open section and on the opposite side of the car from the side doorway. She testified that the car stopped on the stem of the Y for a short time, she did not "know how long, just for a second or so"; that no one arose or gave any signal then; and that after the car began moving backward Mrs. Robinson arose, walked to the side doorway, and "stepped off" the car, it being then about half way around the curve. We quote the following from her cross-examination:

"Q. You don't know whether she stepped off the car, or whether she fell off, or was thrown off? A. She stepped off. Q. How do you know that? A. Because I was watching her. Q. Why were you watching her? A. Because I wondered if she was going to get off. I thought she was going to stop at the door until the car got around, and instead she walked right off. Q. You were sitting in the front, closed car? A. I was not sitting in front. I was sitting by the door [meaning the door between the two sections]. Q. And had been sitting by her coming up? A. Yes."

It should be said of this witness that she appears to have been entirely disinterested and without any acquaintance with Mrs. Robinson, the motorman, or the conductor. The third passenger was also a woman, and was not called as a witness; her identity being undiscovered. The evidence included several photographs, admitted to be correct, illustrating the various positions of the car, its division into sections, and some other matters bearing upon the inquiry. In so far as effect has not already been given to them, they tended to show that one in Mrs. Haskill's position could not have had as full or as continuous a view of her mother's movements and position as is indicated in her testimony; that one in Miss Baumgartner's position could have seen all she claims to have seen, if it actually occurred; and that at the place where Mrs. Robinson fell, which was on the convex side of the curve, the side line of the car midway between its ends is nearly above the rail, so that one falling directly to the ground at that place would be in closer proximity to the rail than if the track were straight.

It is apparent that the only evidence having any tendency to sustain the negligence charged as the cause of the accident—that is, that the car was negligently backed around the curve at a recklessly rapid rate, thereby breaking Mrs. Robinson's hold of the upright bar and throwing her through the open doorway—was the testimony of Mrs. Haskill that her mother was standing at the doorway holding to the bar with her left hand, that the car was backing "very swiftly," or "very rapidly," and that her mother said, after the accident, "Oh! why did they not stop that car, and why did they go around there so fast?" and also the conceded fact that the mother fell to the ground in front of the doorway about midway of the curve, which was about 50 feet from where Mrs. Haskill stood and about 25 feet from where the doorway passed out of her sight. Without now considering whether, if there were no other testimony, this would have justified a jury in finding that the car was backed at a negligently excessive speed, considering the place, thereby breaking Mrs. Robinson's hold on the bar and throwing her through the doorway, we are of opinion that, in the presence of the other evidence, such a finding would have been without any reasonable justification. The statements of Mrs. Haskill respecting the speed, as also the one attributed to her mother, were quite indefinite, gave but little idea of the rate referred to, and related to a subject upon which their opinions were of little value. Besides, the statement attributed to the mother indicated that she thought the car had not stopped, when all agree that it had.

Opposed to that testimony were the definite statements of the motorman and conductor, whose experience and closer observation enabled them to speak with precision and made their opinions of real value. In addition, their testimony was strongly sustained in different ways. Mrs. Robinson fell immediately at the side of the car, as would likely have been the case if she incautiously stepped from it when it was moving moderately, and not away from it, as would likely have been the case if her hold had been broken and she had been thrown through the doorway by any excessive speed. Again, the distance from one stopping place to the other was only a little over 100 feet, or about

three car lengths, and it is more than improbable that the car would have been moved at an immoderate rate in going so short a distance. Lastly, Mrs. Robinson's fall is accounted for, consistently with the moderate movement of the car, by Miss Baumgartner, whose testimony was positive and contained nothing to suggest that it was not disinterested and credible. These considerations make it plain, as we think, that the evidence upon the question of the defendant's negligence, which was charged as the cause of the accident, preponderated so clearly against the plaintiffs as to have entitled the defendant to a directed verdict.

The judgment is accordingly affirmed.

PORTLAND GOLD MINING CO. v. DUKE.

(Circuit Court of Appeals, Eighth Circuit. September 21, 1908.)

No. 2,510.

1. MASTER AND SERVANT—DUTIES DISTINGUISHED—NEGLIGENT DEPARTURE FROM REASONABLY SAFE METHOD OF WORK.

As between master and servant, the duty of so using a reasonably safe place, of so operating reasonably safe machinery, and of so conforming to an established and reasonably safe method of work, that injury will not be inflicted negligently, is the duty of those to whom the work is intrusted, and is no part of the positive duty of the master.

[Ed. Note.—For cases in point, see Cent. Dig. vol. 34, Master and Servant, §§ 266, 267.]

2. STATUTES—ENACTMENT—CONSTITUTIONAL REQUIREMENTS—ENTRY OF FINAL VOTE IN COLORADO.

The provision of Const. Colo. art. 5, § 22, that "no bill shall become a law * * * unless on its final passage the vote be taken by ayes and noes, and the names of those voting be entered on the journal," as construed by the Supreme Court of the state, is mandatory, and a failure to comply with it is fatal.

[Ed. Note.—For cases in point, see Cent. Dig. vol. 44, Statutes, § 20.]

3. SAME—EXISTENCE OF PUBLIC STATUTE IS QUESTION OF LAW, AND CANNOT BE MADE AN ISSUE OF FACT BY THE PLEADINGS.

Whether or not a purported public statute is a law or is not a law is a question of law, which may be presented and determined in like manner as any other question of law is presented and determined, and it cannot be made an issue of fact by the pleadings.

4. SAME—COLORADO FELLOW SERVANT ACT OF 1901 NEVER BECAME A LAW.

The purported act of the Legislature of Colorado approved March 28, 1901 (Sess. Laws 1901, p. 161, c. 67, abrogating the fellow servant rule of the common law, never became a law, because, as held by the Supreme Court of the state in *Rio Grande Sampling Co. v. Catlin*, 40 Colo. 450, 94 Pac. 323, and as shown by the published legislative journals, of which judicial notice must be taken, the constitutional mandate relating to the entry of the vote upon the final passage of a bill was not observed in its enactment.

[Ed. Note.—For cases in point, see Cent. Dig. vol. 44, Statutes, § 20.]

(Syllabus by the Court.)

In Error to the Circuit Court of the United States for the District of Colorado.

Charles W. Waterman (Joel F. Vaile and Henry McAllister, Jr., on the brief), for plaintiff in error.

James A. Orr, Louis W. Cunningham, C. M. Hawkins, and H. M. Mason, for defendant in error.

Before SANBORN and VAN DEVANTER, Circuit Judges, and PHILIPS, District Judge.

VAN DEVANTER, Circuit Judge. This was an action to recover for personal injuries, and the principal question presented to us is whether the Circuit Court erred in refusing to direct a verdict for the defendant at the close of the evidence.

The injuries were sustained in a reduction mill which the defendant was operating in the state of Colorado, and in which the plaintiff was an employé. One of the appliances in the mill was a belt, with metallic cups thereon, whereby crushed ore was conveyed from a pit in the lower part of the mill to a higher part. Motion was communicated to this conveyor by the upper of the two pulleys around which it traveled, and near that pulley was a driving wheel, carried by the same shaft and driven by a power belt connecting with another shaft. The conveyor traveled very rapidly and when it became choked at the lower end, as was sometimes the case, it stopped suddenly and caused the power belt to slip off the driving wheel. On such occasions it was necessary to place the power belt upon the wheel again; and it was also the practice to stop the other machinery, loosen whatever was choking the conveyor, and start the machinery slowly, upon a signal from one of the workmen, while others lifted upon the conveyor to get it in motion. When this practice was followed the act of lifting upon the conveyor was not dangerous. It was while the plaintiff, in the proper discharge of his duties, was lifting upon the conveyor, in an attempt to get it in motion, that his injuries were sustained. The negligence charged against the defendant, so far as it needs to be here noticed, was stated in the complaint in this way:

"While plaintiff was discharging the duties of said employment, and while he was on the third floor or landing of said building, he was ordered and directed by the defendant to help start the elevator, which had become clogged and stopped, and while endeavoring to comply with said order, and while having hold of said elevator, and of the belt and buckets or cups constituting the same, and while endeavoring to loosen it, the said elevator was by the defendant, its officers, agents, servants, and employés, negligently started with great force and velocity, and without any notice or warning to, and without the knowledge of, plaintiff, whereby plaintiff was caught by said elevator, and by the buckets and cups and belt thereof, and was thrown and dragged with great force and violence upon, into, and through said elevator, thereby receiving the injuries hereinafter specified."

The plaintiff had assisted in this work on several occasions, in all of which the practice before recited was followed, and on this occasion he conducted himself as he had always done before. But the established practice was not followed this time. An employé in the lower part of the mill attempted to stop the other machinery in the usual way, but the rope provided for that purpose broke when he pulled it; and while the other machinery was moving at high speed other employés replaced the power belt upon the driving wheel without warn-

ing the plaintiff that the conveyer would start with unusual suddenness and rapidity, thereby making his position one of danger. They knew that the other machinery was moving at high speed; but its movement was not known to him, and was not readily observable by one in his position. He was acting in the belief that the established practice was being followed, and he had no reason to think otherwise. When the power belt was replaced, the rapid motion of the other machinery was instantly communicated to the conveyer, and it quickly caught him and inflicted serious injuries upon him. There was no evidence of any negligence in respect of the rope which broke, or in respect of any matter other than the replacing of the power belt, when the other machinery was moving at high speed, without any warning to the plaintiff of his peril. One of the men participating in and directing this work was a foreman in the mill; but there was no evidence tending to show that he was other than a fellow servant, within the proper definition of that term. See *Baltimore & Ohio R. R. Co. v. Baugh*, 149 U. S. 368, 384, 13 Sup. Ct. 914, 37 L. Ed. 772; *Alaska Mining Co. v. Whelan*, 168 U. S. 86, 18 Sup. Ct. 40, 42 L. Ed. 390; *Westinghouse, etc., Co. v. Callaghan*, 83 C. C. A. 669, 155 Fed. 397; *Vilter Mfg. Co. v. Otte*, 84 C. C. A. 673, 157 Fed. 230. Such was the case made by the evidence, if the conflicts therein and in the inferences reasonably to be drawn from different portions of it be resolved in favor of the plaintiff, as must be done in considering whether the case should have been taken from the jury.

This statement makes it plain that the only negligence shown was that of the plaintiff's fellow servants. Any other conclusion would contravene the settled rule that, as between master and servant, the duty of so using a reasonably safe place, of so operating reasonably safe machinery, and of so conforming to an established and reasonably safe method of work, that injury will not be inflicted negligently, is the duty of those to whom the work is intrusted, and is no part of the positive duty of the master. *American Bridge Co. v. Seeds*, 75 C. C. A. 407, 144 Fed. 605, 11 L. R. A. (N. S.) 1041; *Kinnear Mfg. Co. v. Carlisle*, 82 C. C. A. 81, 152 Fed. 933.

By the common law the master is not responsible for injuries sustained by a servant through the negligence of a fellow servant, and so we are brought to the question whether the common-law rule had been abrogated in Colorado. A purported act of the state Legislature approved March 28, 1901 (Sess. Laws 1901, p. 161, c. 67), which, if it be valid, may have had that effect, is relied upon by the plaintiff, but its validity is questioned by the defendant upon the ground that in its enactment a mandatory requirement of the state Constitution was not observed. Section 22 of article 5 of the Constitution of the state declares:

"And no bill shall become a law except by a vote of a majority of all the members elected to each house, nor unless on its final passage the vote be taken by ayes and noes and the names of those voting be entered on the journal."

The defendant asserts, and the plaintiff does not deny, that the requirement respecting the entry of the vote upon the final passage

was not observed, and to sustain its assertion the defendant calls attention to the pertinent portions of the published legislative journals, which a law of the state declares—

“shall be taken and held as prima facie evidence of the original records.”
Sess. Laws 1899, p. 240, c. 109.

Whether the requirement respecting the entry of the vote on final passage is directory or mandatory, and whether a failure to comply with it, if shown by the legislative journals, prevents the act from becoming a law, are questions relating to the construction and application of the state Constitution, upon which the decision of the Supreme Court of the state is controlling. *Town of South Ottawa v. Perkins*, 94 U. S. 260, 24 L. Ed. 154; *Post v. Supervisors*, 105 U. S. 667, 26 L. Ed. 1204; *School District v. Chapman*, 82 C. C. A. 35, 152 Fed. 887. These questions were presented to that court in the case of *Rio Grande Sampling Co. v. Catlin*, 40 Colo. 450, 94 Pac. 323, wherein the validity of the act now before us was in question, and in a decision en banc, adhered to upon a petition for a rehearing, it was held that the requirement is mandatory; that a failure to comply with it, if shown by the legislative journals, is fatal; that it appears from the published journals that it was not complied with in respect of this act; and that an attempt made by a succeeding session of the Legislature to correct the error was ineffectual. In this situation, and especially as there is no claim that the published journals are not correct or complete reproductions of the original records, and as an inspection of the published journals shows that they sustain the decision of the Supreme Court of the state, it would seem that our duty is altogether plain.

But it is urged by the plaintiff that the existence of the act is not in question in this case, because it was not put in issue by the defendant's answer. It is true that the answer is silent in that regard, but that is also true of the plaintiff's complaint. Possibly the silence of the answer may be accounted for on the theory that there was no occasion for the defendant to controvert what was not affirmed by the plaintiff; but a better explanation of the silence of the pleadings of both is that the question of the existence of a public statute is one of law and cannot be made an issue of fact by the pleadings. It must be conceded, however, that the plaintiff's contention has support in decisions of the Supreme Court of Colorado, which follow and apply like decisions of the Supreme Court of Illinois; but as this practice in the state of Colorado is not grounded upon any constitutional or statutory provision, it is not obligatory upon the federal courts. Such is the rule of decision in the Supreme Court of the United States, where the question has been much considered in cases taken to that court on error to the federal courts in Illinois. *Town of South Ottawa v. Perkins*, 94 U. S. 260, 24 L. Ed. 154; *Post v. Supervisors*, 105 U. S. 667, 26 L. Ed. 1204. In the first of these cases it was said:

“That which purports to be a law of a state is a law, or it is not a law, according as the truth of the fact may be, and not according to the shifting circumstances of parties. It would be an intolerable state of things if a document purporting to be an act of the Legislature could thus be a law in one

case and for one party, and not a law in another case and for another party; a law to-day and not a law to-morrow; a law in one place and not a law in another, in the same state. And whether it be a law, or not a law, is a judicial question, to be settled and determined by the courts and judges. * * * But the law under consideration has been passed upon by the Supreme Court of Illinois, and held to be invalid. This ought to have been sufficient to have governed the action of the court below. In our judgment it was not necessary to have raised an issue on the subject, except by demurrer to the declaration. The court is bound to know the law, without taking the advice of a jury on the subject. When once it became the settled construction of the Constitution of Illinois that no act can be deemed a valid law unless by the journals of the Legislature it appears to have been regularly passed by both houses, it became the duty of the courts to take judicial notice of the journal entries in that regard. The courts of Illinois may decline to take that trouble, unless parties bring the matter to their attention; but, on general principles, the question as to the existence of a law is a judicial one, and must be so regarded by the courts of the United States. This subject was fully discussed in *Gardner v. Collector*. After examining the authorities, the court in that case lays down this general conclusion: "That whenever a question arises in a court of law of the existence of a statute, or of the time when a statute took effect, or of the precise terms of a statute, the judges who are called upon to decide it have a right to resort to any source of information which in its nature is capable of conveying to the judicial mind a clear and satisfactory answer to such question, always seeking first for that which in its nature is most appropriate, unless the positive law has enacted a different rule." 6 Wall. 511, 18 L. Ed. 890. Of course, any particular state may, by its Constitution and laws, prescribe what shall be conclusive evidence of the existence or nonexistence of a statute; but, the question of such existence or nonexistence being a judicial one in its nature, the mode of ascertaining and using that evidence must rest in the sound discretion of the court on which the duty in any particular case is imposed. Not only the courts, but individuals, are bound to know the law, and cannot be received to plead ignorance of it."

The controlling character of that decision is not weakened, but strengthened, by the fact that there was a dissenting opinion, in which the dissenting justices, while conceding that the view of the majority was probably more logical, took the position that the decisions of the Supreme Court of Illinois had made the question of the existence of the statute one of fact, and not of law. A later case recognizing the same general rule is *Jones v. United States*, 137 U. S. 202, 214, 216, 11 Sup. Ct. 80, 84, 85, 34 L. Ed. 691, where it is said:

"All courts of justice are bound to take judicial notice of the territorial extent of the jurisdiction exercised by the government whose laws they administer, or of its recognition or denial of the sovereignty of a foreign power, as appearing from the public acts of the Legislature and executive, although those acts are not formally put in evidence, nor in accord with the pleadings."

And again:

"In the ascertainment of any facts of which they are bound to take judicial notice, as in the decision of matters of law which it is their office to know, the judges may refresh their memory and inform their conscience from such sources as they deem most trustworthy. *Gresley, Eq. Ev.*, pt. 3, c. 1; *Fremont v. United States*, 17 How. 542, 557, 15 L. Ed. 241; *Brown v. Piper*, 91 U. S. 37, 42, 23 L. Ed. 200; *State v. Wagner*, 61 Maine, 178. Upon the question of the existence of a public statute, or of the date when it took effect, they may consult the original roll or other official records. *Spring v. Eve*, 2 Mod. 240; 1 Hale's *Hist. Com. Law* (5th Ed.) 19-21; *Gardner v. Collector*, 6 Wall. 419, 18 L. Ed. 890; *South Ottawa v. Perkins*, 94 U. S. 260, 267-269, 277, 24 L. Ed. 154; *Post v. Supervisors*, 105 U. S. 667, 26 L. Ed. 1204. As to international

affairs, such as the recognition of a foreign government, or of the diplomatic character of a person claiming to be its representative, they may inquire of the Foreign Office or the Department of State. *Taylor v. Barclay*, 2 Sim. 213; *The Charkieh*, L. R. 4 Ad. & Ec. 59, 74, 86; *Ex parte Hitz*, 111 U. S. 766, 4 Sup. Ct. 698, 28 L. Ed. 592; *In re Baiz*, 135 U. S. 403, 10 Sup. Ct. 854, 34 L. Ed. 222."

The rule so stated is now also the prevailing one in the state courts, as is shown in *Sutherland on Statutory Construction* (2d Ed.) §§ 57-59, where the cases are collected. It will suffice to refer to one in which Mr. Justice Marshall, speaking for the Supreme Court of Wisconsin, uses this concise language:

"It must be understood that, when the existence or the contents of a statute are called in question, no issue of fact is presented for a trial upon the evidence; but the court, whether one of original or appellate jurisdiction, must necessarily decide the question the same as it decides any other question of law." *Milwaukee County v. Isenring*, 109 Wis. 8, 26, 85 N. W. 131, 137, 53 L. R. A. 635.

We conclude that, notwithstanding its failure to put the existence of the act upon which the plaintiff relies in issue by its answer, the defendant was entitled to raise that question, and to invoke a decision thereof, in like manner as it was entitled to raise, and invoke a decision of, any other question of law necessarily involved in a determination of its asserted right to a directed verdict at the close of the evidence. Rightly considered, the second ground of its request for such a direction contained two propositions: One, that there was no right of recovery, unless there was negligence on its part; and the other, that there was no evidence of any such negligence. By that request the plaintiff's right to recover for injuries sustained solely through the negligence of his fellow servants was as effectually challenged as it would have been if the facts had been correctly stated in the complaint and the defendant had challenged its sufficiency by a demurrer. The adverse ruling upon that request involved an affirmation of the existence of a law giving a right of recovery in such a case quite as certainly as would a like ruling upon such a demurrer. But, as we have seen, there was no such law in existence; the act relied upon by the plaintiff never having become a law, because not enacted in conformity with the constitutional mandate. We cannot give effect to the enrolled and published act, to which our attention is directed by the plaintiff, and refuse to give effect to the legislative journals, to which our attention is directed by the defendant, when both are properly within our judicial notice and when the journal entries are made by the Constitution, as interpreted by the Supreme Court of the state, the controlling criteria in determining whether the act became a law.

As there was no evidence of any negligence to the part of the defendant, and as there was no law of the state abrogating the fellow-servant rule of the common law, it follows that a verdict for the defendant should have been directed, as was requested.

This conclusion renders it unnecessary to consider other questions discussed in the briefs, namely, whether it was admissible for the plaintiff to so state his cause of action in a single count as to ground it upon both the common law and the statute—that is, upon the negligence of both the defendant and the plaintiff's fellow servants; whether the

allegations of the complaint were sufficiently specific and full to state a cause of action under the statute; and whether the irregularities and infirmities, if any, in the complaint, were waived by a failure to take timely advantage of them.

The judgment is reversed, with a direction to grant a new trial.

POLAND v. LOVE.

(Circuit Court of Appeals, Eighth Circuit. September 21, 1908.)

No. 2,664.

ASSIGNMENTS—EQUITABLE ASSIGNMENT—BANK CHECK—GARNISHMENT.

The mere giving of a check on an ordinary deposit account in a bank, in the usual course of business, in payment of a past indebtedness, does not amount to an equitable assignment, even though the drawer makes a deposit expressly to cover the check; and a garnishment of the bank, after other deposits have been made and checks given, but before such check has been presented, creates a lien on the deposit superior to the rights of the payee.

[Ed. Note.—For cases in point, see Cent. Dig. vol. 4, Assignments, § 90.]

In Error to the United States Court of Appeals in the Indian Territory.

Potter, Bowman & Potter, for plaintiff in error.

W. O. Davis and R. E. Thomason, for defendant in error.

Before HOOK and ADAMS, Circuit Judges, and PHILIPS, District Judge.

HOOK, Circuit Judge. This is a controversy over money on deposit in the First National Bank of Ardmore. Love, the defendant in error, claims it by virtue of a garnishment of the bank in an action against the depositor, and Poland, the plaintiff in error, because of a check given him by the depositor about two weeks before, but not presented to the bank for payment until two days after the garnishment. A judgment in favor of Poland, who interpleaded in Love's action, was reversed by the Court of Appeals in the Indian Territory. 5 Ind. T. 202, 82 S. W. 721, 67 L. R. A. 617. At the next trial Love had judgment, it was affirmed by the Court of Appeals, and Poland prosecuted this writ of error.

The common debtor of the two litigants was W. D. Peake. Through one O'Mealey, as manager, he conducted a brokerage and commission business at Ardmore under the name of the Ardmore Stock Exchange, and also as W. D. Peake & Co. When Love's action was begun the Stock Exchange alone was named as defendant in the complaint and in the writ of garnishment, and Poland contends the garnishment is invalid, because the Stock Exchange was not a corporation suable in its corporate name, or the firm name of a partnership, or the trade-name of an individual. But the proof shows it was the trade-name used by Peake's manager in the transaction out of which Love's demand arose and in similar transactions with others, and when the ob-

jection was interposed Love made appropriate amendments, with leave of the trial court, exhibiting the actual situation. Neither Peake, the debtor, nor the bank, as garnishee, appealed from the judgment sustaining the garnishment.

We therefore proceed to Poland's next contention, that by the check given him by Peake's manager and the attendant circumstances there was an equitable assignment to him of the money in the bank, and it was therefore no longer subject to garnishment at the suit of a creditor of the depositor. Reliance is placed on *Fourth Street Bank v. Yardley*, 165 U. S. 634, 17 Sup. Ct. 439, 41 L. Ed. 855, in which it is held that, whilst an equitable assignment or lien will not arise against a deposit solely by reason of a check drawn against it, yet if, in connection with the delivery of the check, it was the understanding and agreement of the parties that an advance about to be made should be a charge on and be satisfied out of a specified fund, a court of equity will lend its aid to carry the agreement into effect as against the drawer of the check, mere volunteers, and persons charged with notice.

We are of opinion, however, that the case at bar does not fall within the principle there announced. Peake's account, kept by his manager in the bank at Ardmore, was an ordinary customer's account, subject to check. It was the custom not to keep on deposit a large sum of money, and when any considerable demand arose upon settlement with a customer the manager would wire Peake, or Peake's bank, at Ft. Worth, Tex., for a remittance. Upon receipt of a favorable answer, the amount asked for would be credited to the manager's account. When settlement was made with Poland it was found there was due him \$364.41. Shortly before this there had been deposited in the bank which was garnished \$100 received from another customer, so the manager wired to Ft. Worth and secured credit for an additional \$265. Poland was informed of this when his check was given him; but, as already observed, he did not present it for payment until after the bank had been garnished, about two weeks later. In the meantime other deposits were made and other checks given, and when the garnishment writ was served the credit balance was less than the amount of Poland's check. The check was given in an ordinary settlement of a prior transaction. Poland did not extend credit upon the faith of it, or upon the faith of money being placed in the bank, and it does not appear that the bank was advised of the existence of the check until after the garnishment.

The case is the common one of a man fortifying his bank account to stand a check given against it, and the essential features of an equitable assignment are lacking. The mere giving of a check, and its receipt in the ordinary, usual way, does not amount to an equitable assignment; and this is so, even though the check is drawn for the exact amount of the drawer's balance. *Shand v. Du Buisson*, L. R. 18 Eq. 283.

The judgment is affirmed.

LEONA GARMENT CO. v. JENKS et al.

(Circuit Court of Appeals, Seventh Circuit. July 22, 1908.)

No. 1,448.

PATENTS—INFRINGEMENT—WOMEN'S UNDERGARMENT.

The Critcher patent, No. 781,635, for a combination undergarment for women, construed, and held valid and infringed.

Appeal from the Circuit Court of the United States for the Eastern Division of the Northern District of Illinois.

For opinion below, see 160 Fed. 693.

The appellant, Leona Garment Company, as complainant below, filed its bill for infringement of patent No. 781,635, issued to Leona J. Critcher, February 7, 1905, and assigned to such complainant. On final hearing the validity of the patent was upheld, and infringement adjudged and enjoined in respect of one exhibit device made by the defendants; but a subsequent manufacture, referred to as "Defendants' Garment No. 2," was adjudged not an infringement, with denial of relief thereupon. From final decree accordingly this appeal is brought to review such ruling of noninfringement. The patent is for a "combination undergarment," and thus describes the object of invention:

"This invention relates to nether garments, and has for its object the production of a combination undergarment for ladies' use, consisting of two complete articles, skirt and drawers, so combined and arranged with relation to each other that, while each article is in itself complete, yet each article forms a part of the other; the combination undergarment avoiding fullness around the waist and yet giving ample fullness about the hips and around the legs. By the particular arrangement hereinafter described the garment is adjustable to figures of widely-varying waist measure, and also to stout and slender figures, setting perfectly and draping gracefully equally well on all figures."

Drawings appear, of which figure 3 is referred to as a plan view "spread out, showing one of the drawers legs turned up," as follows:

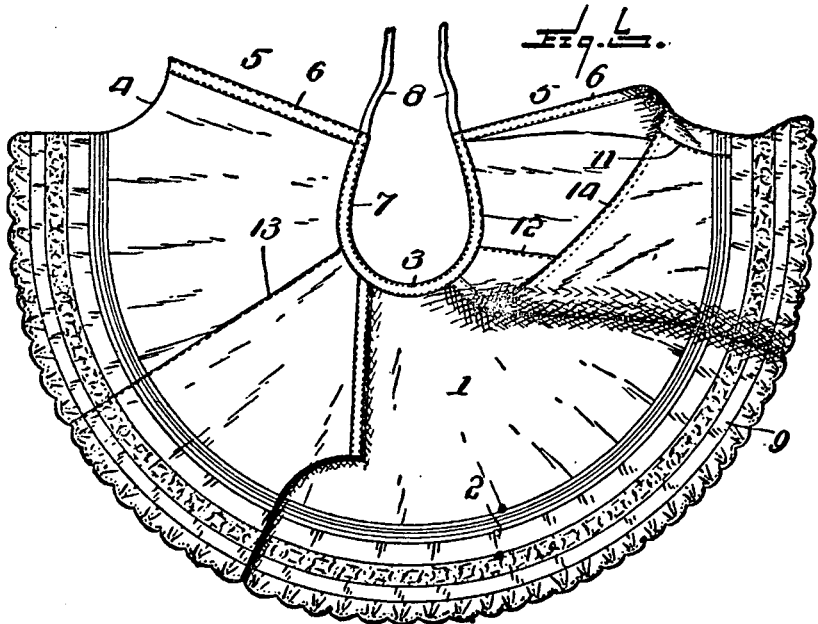

The specifications contain the following descriptions and references:

"The combination undergarment contemplated in this invention embodies three main pieces, which for convenience of description may be termed the 'body' or 'skirt' piece and the 'drawers leg pieces'; the latter constituting essential portions of the drawers. The combination skirt and drawers comprise a skirt having secured thereto upon its inner face upon each of the opposite sides thereof a drawers leg consisting of two wing portions extending from the upper edge of the skirt to the bottom thereof at a suitable distance apart, each wing being gored at the top to form an opening from the waist to the crotch and united together from the crotch to the bottom of the skirt, whereby the drawers leg upon each side of the skirt comprises for its outer wall that portion of the skirt extending between the two wings. The skirt or body piece (indicated at 1), when first cut out and laid flat, is in the form of the segment of a circle or disk, and is preferably made nearly equal to a complete circle, as shown in Fig. 3, thereby giving the requisite fullness about the hips when the garment is made up. The outer or longer curved edge, 2, forms the bottom of the body of the skirt and drawers, the inner or shorter curved edge forms the top or waist line of the skirt, and the short curved and divergent edges, 4, mark the inside seams of the drawers legs of the garment, while the edges, 5, which are subsequently faced, as shown at 6, form the front flap or fly of the drawers; the latter, as well as the skirt, being open at the front similar to ladies' drawers now in use. The upper and shorter edge, 3, is faced, as at 7, coextensive with the length thereof and by preference provided with tie strings or a tape, 8, run through the facing, so that the front edge portions of the garment may be lapped by each other to any desired extent to adapt the garment to varying waist measurements. To the longer bottom edge, 2, is attached the trimming, 9, which may be of any suitable or desired design; said trimming extending also around the bottoms of the drawers legs, as shown. The drawers leg pieces, 10, are counterparts of each other, each being substantially triangular in shape, with one of the lower angles cut off on the line, 11, to correspond in length and curvature with the adjoining edge, 4, of the skirt piece; the edges, 4 and 11, being joined to form the inside seam of the leg portion of the drawers. One of the longer side edges, and what may be termed the 'vertically-attached' edge, 12, of the leg piece, is united to the skirt or body piece, 1, along the line, 13, throughout the whole length of the skirt, as well as the drawers, while the other side edge, 14, of the leg piece, extends obliquely and should be properly hemmed or bound throughout its length from the waistband to the upper extremity of the inside leg seam. The extreme upper part of the leg piece is secured firmly to the waistband, 7, and in fact constitutes a stay for the leg of the drawers, in that by means of said extended stay portion or piece the drawers leg is supported directly from and by the waistband. Another very important feature resides in the fact that the side edges, 12 and 14, of the leg piece are crossed intermediate of their ends, thereby causing the outer side of the leg and stay piece to lie against the inner side of the skirt or body piece of the garment."

It is further stated: "The body of the garment may also be cut from two pieces of material, instead of one, to better adapt the garment to extra large figures," and "various changes may be made in the form, proportion, and minor details without departing from the" invention.

The claim is: "The herein-described combined skirt and drawers comprising a skirt and wings secured to the inner face thereof extending from top to bottom of the skirt and forming portions of the drawers legs, each drawers leg consisting of one wing and the adjacent side edge portion of the skirt, each wing being gored at the top to form an opening from the waist to the crotch and united to the extreme side edge of the skirt from the crotch to the skirt bottom; the forward edges of the drawers forming the front of the skirt and being adapted to overlap each other."

The defendants' production, which was found to be an infringement, appears to have been copied from the patent specifications. In their later manufacture, involved in this review, variations appear which are described in our opinion.

W. Clyde Jones and Arthur B. Seibold (Keene H. Addington and Robert Lewis Ames, of counsel), for appellants.

Genevieve Sutherland, pro se.

Before GROSSCUP, BAKER, and SEAMAN, Circuit Judges.

SEAMAN, Circuit Judge (after stating the facts as above). The patent in suit, No. 781,635, is for a combination undergarment for women, which unites in one garment an underskirt and drawers, with each complete in itself, and the device for such combination is plainly described in the specifications and embraced in the single claim of invention. While various means and forms of combination garments were in use and well known prior to the application for this patent—including combined skirt and trousers for riding and bicycle habits—and two prior patents appear for combined skirt and drawers, the novelty of this patentee's device for such combination is not impeached, as we believe, by any of the patents introduced or other evidence in the record, and its utility is well established. The validity of the patent is upheld by the decree appealed from, but one of the combination skirt and drawers made by the appellees, under the name of "Ideal"—referred to in the record as "Defendants' Garment No. 2"—is adjudged to be no infringement of the patent. This ruling upon the issue of infringement is assigned as error, and the solution is not free from difficulty, as it rests on interpretation of the monopoly granted, in the light of the prior art, without the aid of expert testimony on behalf of the appellees, or representation by counsel at the bar of this court. We have considered, however, the careful opinion of the trial court, together with the brief there submitted by counsel on the part of the appellees (as certified to this court), and an intelligent oral explanation of the respective garments in question, made by one of the appellees at the bar of this court, on leave granted, for want of representation by counsel.

The purpose of the invention, as stated in the patent, was to make such combination of skirt and drawers in one garment that the function of each was preserved, with ready adjustment to various figures, "draping gracefully," and eliminating the double thickness of material at the waist and hips imposed upon the wearer of two garments. It clearly appears that each of these functions was desired in a combination garment for women, and that the want was not satisfactorily met by either of the prior patent combinations in evidence—Burgard's, No. 700,477, or Chittenden's, No. 765,556—as both failed to provide the needful skirt effect in covering the openings in drawers, front and rear, in various movements of the wearer, aside from other defects.

The combination garment of the patent, as therein specified, "embodies three main pieces, which for convenience of description may be termed the 'body' or 'skirt' piece and the 'drawer leg pieces.'" The body piece is cut from the material into segmental shape, "nearly equal to a complete circle (as shown in figure 3 of the drawings), to give the requisite fullness about the hips when the garment is made up"; and the longer periphery forms the bottom of skirt and drawers, while "the inner or shorter curved edge forms the top or waist line." The two leg pieces for drawers (shown in figure 3) are cut triangular in shape and attached as wings to the face of the skirt piece, extending from

top to bottom, "each wing being gored at the top to form an opening from the waist to the crotch, and united to the extreme side edge of the skirt from the crotch to the skirt bottom; the forward edges of the drawers forming the front of the skirt and being adapted to overlap each other." These parts united form "a ready-made" garment, which appears to possess all of the qualities above stated as the objects of the invention, and all due to the novel devices of segmental shape for the basic skirt piece, with the triangular shape of the two wing pieces, gored and arranged thereon to make the drawers, and the overlapping provision for the front of the drawers, so that they close "in coatlike manner," thus giving both complete skirt effect at the front and adjustability to the garment.

These elements in combination are distinctly set forth in the single claim of the patent, and their patentable novelty in such combination is established by the testimony. In the appellees' garment (the "Ideal"), as we understand its structure, every element of the patent combination is employed, substantially, for like purpose and with like result. The alleged distinctions are: (a) That the skirt portion is made of three pieces, instead of a single piece, of material; (b) that the wing pieces are "formed integrally with a part of the skirt portion," instead of cutting them out separately to be sewed thereon, as specified in the patent; and (c) that such severance of the skirt affords advantage in the fit of the garment, because the bias of the material can be placed at the rear, instead of sides. Nevertheless, the skirt portion enters into the combination in segmental form, and each part is shaped and arranged therein as devised by the patentee. These changes, therefore, due to the first-mentioned expedient of laying out the segmental form of skirt in three pieces—while the patent suggests merely two pieces as an alternative method—furnish no escape from infringement, as we believe, although they may improve the fit, as alleged.

We are of opinion, accordingly, that error is well assigned for denial of relief against such infringement, and the decree of the Circuit Court is reversed, with direction to grant relief in conformity herewith.

DAVIS & ROESCH TEMPERATURE CONTROLLING CO. v. NATIONAL
STEAM SPECIALTY CO.

(Circuit Court, N. D. Illinois, E. D. August 4, 1908.)

No. 27,519.

1. JUDGMENT—PATENTS—SUIT FOR INFRINGEMENT—DEFENSE OF ANTICIPATION
—RES JUDICATA.

In a suit for infringement of a patent, the question of priority of invention is not *res judicata* because of a decision in favor of the patent in interference proceedings in the Patent Office between the same parties; the question whether the patent is void for anticipation being one in which the public has an interest, as well as the parties.

2. PATENTS—ANTICIPATION—ABANDONMENT BY PRIOR INVENTOR.

The making of an invention and its reduction to practice, without any public use or other act placing the public in possession of the invention,

although the inventor may by delay in applying therefor lose his right to a patent, does not constitute an abandonment of the invention to the public, which will invalidate a patent subsequently granted to another therefor.

[Ed. Note.—Abandonment of invention, see note to *Hayes-Young Tie Plate Co. v. St. Louis Transit Co.*, 70 C. C. A. 6.]

3. SAME—THERMOSTAT.

The Roesch patent, No. 759,472, for a thermostat, *held* valid as against the defense of anticipation.

In Equity. On plea.

William O. Belt (James C. Chapin, of counsel), for complainant.

Bulkley, Durand & Drury (Charles C. Bulkley, of counsel), for defendant.

KOHLSAAT, Circuit Judge. Complainant brings suit to restrain infringement of patent No. 759,472, granted to complainant, as assignee of Alfred Roesch, May 10, 1904, for an improvement in thermostats, and patent No. 764,822, granted July 12, 1904, to complainant, as assignee of said Roesch, for an improvement in air-vents. Defendant filed a plea to the bill, so far as it applies to the patent first set out, limited to the defense of anticipation, upon which the cause went to hearing. The facts are as follows, viz.:

Complainant's assignor, Roesch, filed his application for the patent in suit on January 27, 1903, and defendant's assignor filed his application on March 4, 1904. On interference declared, the invention was awarded to Roesch. The defendant claims to have invented and reduced to practice the subject-matter of the patent in suit several years prior to the filing of complainant's application. The examiner disregarded this contention. While interference proceedings were pending, this suit was instituted. By stipulation, the record of the interference proceedings constitutes the evidence here, so that no new question is presented, except such as may be deduced from the action of the examiner.

It is complainant's contention that defendant, who was admittedly privy to the interference proceedings, is precluded thereby from again raising the question of priority. On the other hand, defendant insists that complainant could only avail itself of the doctrine of *res adjudicata* by properly pleading the prior judgment. It must be borne in mind that the question here presented is one in which, as Judge Putnam says, in *Automatic Weighing Machine Co. v. Pneumatic Scale Co.* (C. C.) 158 Fed. 415, the whole public is interested, as against whom no estoppel can be predicated upon the decision in an interference case. While that decision would be very persuasive, it is not, for the purposes of this case, decisive. If, as a matter of fact, Brissenden had publicly reduced the invention to practice prior to the date of Roesch's alleged invention, then, as a matter of course, that being established, the plea of anticipation would be sustained, and the rights of the public would attach.

The plea does not rest upon section 4915 or 4916, Rev. St. (U. S. Comp. St. 1901, pp. 3392, 3393), providing for a hearing on questions

of priority, notwithstanding the decision of the Patent Office, but upon section 4920 (U. S. Comp. St. 1901, p. 3394), which makes anticipation a matter of defense. It may be that, were defendant now seeking to have the invention accorded to him, *res adjudicata* would arise. That need not here be determined. For the first time the public rights are in issue. They have never been adjudicated. The defense of *res adjudicata* is not sustained. It thus becomes unnecessary to dispose of defendant's claim that the pleadings do not admit of that defense to the plea.

Does the evidence establish the defense of anticipation? The patent (No. 759,472) in suit relates to automatic control of devices for heating by means of a thermostat, the operation of which is secured by the application of heat to a valve controlled by some expansible substance, which is made to open and close it automatically, as the heat increases or diminishes. The special feature of the said patent relates only to a metallic tube, which incases the expansible member and is rigidly fastened to it at one point only, to reinforce it and prevent its so-called creeping, while at the same time it permits it to expand and contract freely in performing its work.

The examiner held, first, that the device for which Brissenden filed an application, and which was before him in the interference proceeding, was different from that of 1898 and 1899, and that, under the rule laid down in *Warner v. Smith*, 84 O. G. 311, and in *Quist v. Ostrom*, 108 O. G. 2147, Brissenden's early work amounted merely to an abandoned experiment; and, second, assuming that Brissenden did reduce the invention to practice in 1898, then, under the decisions in *Mason v. Hepburn*, 84 O. G. 147, and *Thomson v. Weston*, 99 O. G. 864, and *Matthes v. Burt*, 114 O. G. 764, the decision must still go to Roesch—these latter cases holding that:

"The first to reduce to practice subordinates or forfeits his rights to a patent, by reason of long and unexcused delay, lack of diligence, and failure to disclose his invention to the public, in favor of a later inventor who has been diligent in putting his invention into use and disclosing it to the public, and has filed his application or obtained his patent."

Undoubtedly there is some difference of opinion in the decisions upon the point of delay in applying for a patent. In *Coffin v. Ogden*, 18 Wall. 120, 21 L. Ed. 821, and *Gayler v. Wilder*, 10 How. 496, 13 L. Ed. 504, the Supreme Court seems to hold that the right to a patent is not thereby lost. While in *Kendall v. Winsor*, 21 How. 322, 16 L. Ed. 165, the same court, speaking of one who designedly delayed application with a view of securing his own advantage, says:

"And with a very bad grace could he appeal for favor or protection to that society which, if he had not injured, he certainly had neither benefited nor intended to benefit. Hence if, during such a concealment, an invention similar to or identical with his own should be made and patented, or brought into use without a patent, the latter could not be inhibited nor restricted upon proof of its identity with a machine previously invented and withheld and concealed by the inventor from the public."

In *Universal Adding Machine Co. v. Comptograph Machine Co.*, 146 Fed. 982, 77 C. C. A. 227, the Circuit Court of Appeals held the invention of the complainant to have been either an inoperative ex-

periment or an abandoned, though practical device, through what is termed "eight years of inaction." In that case the machine was widely advertised and placed in the Census Department's offices, and publicly experimented with, and then laid aside for eight years. In the meantime another inventor had taken out a patent for the same invention. This patent the Comptograph Machine Company sought to have set aside, and the invention awarded to it. It would seem clear that, if the invention was perfected and abandoned, it went to the public.

In the case at bar, six exhibits are introduced to establish reduction to practice, dating back to 1898 and 1899. Claims 1, 2, and 4 of Brissenden's application seem to fairly cover the device of Roesch, as well as describe the device of exhibits of 1898 and 1899, though some of the details are not so clearly shown as could be desired. The examiner says:

"It seems not improbable that Brissenden obtained knowledge of the manufacture and sale of the Roesch device, and was stimulated thereby to again take up his device and to file an application therefor."

And he cites the close resemblance of Brissenden's application to that of Roesch, rather than to those of the exhibits, and adds:

"When Brissenden finally perfected his invention a year later than his rival, it was in different form from those of his early experiments."

About six years intervened the date of Brissenden's alleged reduction to practice and the filing of his application. At the time of filing defendant's application, complainant's device was on the market, and had been for about a year. More than 1,000 had been sold, and it had been extensively advertised. Brissenden had abundant opportunity to appropriate it. The attempt to excuse delay by showing poverty was justly disregarded by the examiner upon the record presented.

As to what the examiner terms "Count 3": The date of invention does not antedate the original application of 1904, and therefore it need not be here further considered.

It is clear that Brissenden, under the facts of the case, could not himself secure a patent at this time. Whatever interest in the invention he may have had must be treated as lost through his delay and the subsequent discovery of Roesch. *Bates v. Coe*, 98 U. S. 31, 25 L. Ed. 68; *Eck v. Kutz* (C. C.) 132 Fed. 758; *Western Elec. Co. v. Sperry Elec. Co.*, 58 Fed. 186, 7 C. C. A. 164. This he seems to recognize by his plea setting up abandonment to the public and consequent anticipation. The facts, however, as they appear in the record, fail to sustain this contention. Mere reduction to practice, without any public use or other act placing the public in possession of the invention, does not constitute abandonment. Abandonment will not be lightly presumed, but must be fully proved. *Mast, Foss & Co. v. Dempster Mill Mfg. Co.*, 82 Fed. 327, 27 C. C. A. 191.

The Brissenden experiments do not seem to have been attended by any public use, or publicity of any kind. They were tested in the office of his employer. One was placed on trial in the office of

one Bruch. No movement was made, calculated to advise the public. While the tests seem to have been fairly satisfactory, it does not appear that they were in any way made public. There is no attempt to show that Roesch ever knew of them. It seems likely that, but for Roesch's supposed discovery of the invention, the public might never have received the benefit of it. It was not in possession of sufficient knowledge thereof to enable it to put it into practice. It was not prejudiced by the award to Roesch, and is not entitled to relief as against him. The plea is therefore overruled.

TURNER BRASS WORKS et al. v. APPLIANCE MFG. CO.

(Circuit Court, N. D. Illinois, E. D. August 4, 1908.)

No. 28,979.

PATENTS—SUIT FOR INFRINGEMENT—PRELIMINARY INJUNCTION—PRIOR ADJUDICATION.

Ordinarily a decision of the Patent Office in interference proceedings, awarding a patent to one of two applicants, does not constitute a prior adjudication of the validity of the patent, which will warrant the granting of a preliminary injunction to restrain its infringement even against the unsuccessful applicant, nor estop him from contesting its validity, except on the ground of his own priority of invention.

[Ed. Note.—For cases in point, see Cent. Dig. vol. 38, Patents, § 486.

Grounds for denial of preliminary injunctions in patent infringement suits, see note to *Johnson v. Foos Mfg. Co.*, 72 C. C. A. 123.]

In Equity. On motion for preliminary injunction.

George T. May, Jr. (Frederick W. Moore, of counsel), for complainants.

Dyrenforth, Lee, Chritton & Wiles (William B. Davies, of counsel), for defendant.

KOHLSAAT, Circuit Judge. This cause is now before the court on motion for a preliminary injunction. The bill seeks to restrain defendant from infringement of patent No. 873,544, granted to Harroun, December 10, 1907, for an automobile fender. The defense rests upon want of validity alone. The following facts are relied on by complainants to bring the cause within the requirements of the courts in cases where a preliminary injunction is sought: Both Harroun and one Schureman were applicants in the Patent Office for patents covering substantially the device of the patent in suit. An interference being declared, Schureman abandoned all further effort, and his claims, so far as pertinent, were awarded to Harroun. Thereafter Schureman organized the defendant company and proceeded to manufacture the device of his original application, in substance, paying no regard to the rights granted to Harroun.

Both complainant and defendant, respectively, claim to have established a fair business. There was, so far as shown, no contest in the Patent Office; nor does it appear that Schureman knew what matters were urged by Harroun in support of his application. There is no

sufficient ground shown for charging him with bad faith in asserting the invalidity of the patent in suit, in view of the prior art, as defendant now does assert; so that the cause does not come within those decisions which deal with that question. No continued public acquiescence is claimed. Unless the action of the Patent Office in awarding priority on interference amounts to the prior adjudication contemplated in *Standard Elevator Co. v. Crane*, 56 Fed. 718, 6 C. C. A. 100, the court would seem to be without authority to enjoin defendant in limine.

Primarily, the only question raised in interference proceedings is that of priority. Of course, should the examiner discover indubitable nonpatentability in the subject-matter of the applications, it would be his duty to reject both applications, as not presenting any matter or rights upon which he could act; but, generally speaking, the only vitality a patent so issued could possess, as to validity, in the absence of matters creating an estoppel, even against the defeated party, would be that bare presumption which attaches to a grant of the Patent Office. Ordinarily, the decision on interference does not raise the presumption of validity required. *Newhall v. McCabe Hanger Mfg. Co.*, 125 Fed. 919, 60 C. C. A. 629, and cases cited; *Automatic Weighing Machine Co. v. Pneumatic Scale Corp.* (C. C.) 158 Fed. 415; *Reed Mfg. Co. v. Smith & Winchester Co.*, 107 Fed. 719, 46 C. C. A. 601, and cases cited; *Empire State Nail Co. v. American S. L. Button Co.* (C. C.) 61 Fed. 650.

It is urged that defendant is estopped from attacking the validity of the patent in suit for the reason that Schureman was in the Patent Office asserting patentable novelty. In the absence of proof that he was then fully advised of the condition of the prior art and is now acting in bad faith, the position is not tenable. Both by statute and decisions, defendant is entitled to contest the finding of the Examiner of Patents upon every question at a final hearing. *Walker on Patents* (4th Ed.) § 142, and cases cited. For the purpose of this motion, he would, under the rule laid down by Judge Quarles in *Laas v. Scott* (C. C.) 145 Fed. 195, and affirmed 150 Fed. 764, 80 C. C. A. 500, be precluded from raising the question of priority. This defendant does not seek to do at the present time.

It will be noted that the Court of Appeals, in affirming, reassert the principle of law that on an application for an injunction pendente lite the presumptions arising from the grant of a patent must be "reinforced by the decision of a competent court upholding the invention upon issues duly raised and fairly litigated." The validity of the patent is vigorously assailed, so strenuously, indeed, that the court is not able unhesitatingly to say that there is unquestioned patentable novelty upon the record now presented—novelty so clear and convincing as to justify a prejudgment of the case. Nor are the circumstances of the case such as to take it outside the requirements of the *Elevator Case* above cited.

The motion for a preliminary injunction is denied.

BROWNING et al. v. FUNKE.

(Circuit Court, S. D. New York. May 27, 1908.)

1. PATENTS—INFRINGEMENT—MAGAZINE FIREARM.

The Browning patent, No. 580,925, for a magazine firearm, claim 14, if conceded invention and validity, *held* not infringed.

2. SAME—INVENTION.

The Browning patent, No. 730,870, for a magazine firearm, claims 37, 38, and 39, are void for lack of invention.

In Equity. On final hearing.

Redding, Greeley & Austin (William A. Redding, of counsel), for complainants.

Grafton L. McGill (J. Nota McGill and Frederic D. McKenney, of counsel), for defendant.

HOLT, District Judge. This is a suit in equity to enjoin the alleged infringement of two letters patent—one No. 580,925, dated April 20, 1897, and the other No. 730,870, dated June 16, 1903—granted to John M. Browning, one of the complainants. Both patents relate to recoil-operated magazine firearms. The bill alleges infringement of claim 14 of patent No. 580,925, and of claims 37, 38, and 39 of patent No. 730,870.

Claim 14 of patent No. 580,925 is as follows:

"14. In a firearm, the combination of a sliding breech-bolt, a hammer cocked by the movement of the breech-bolt, a sear having a point to engage said hammer, a trigger to operate said sear, a latch freely movable to engage said sear-point and prevent its release from the hammer and to release said sear-point, and a spring acting upon said latch to hold it normally in engagement with the sear-point and yielding to permit its release."

This claim was originally claim 15, in the application originally filed, and then read as follows:

"15. In a fire-arm, the combination of a sliding breech-bolt, a hammer cocked by the movement of the breech-bolt, a sear having a point to engage said hammer, a trigger to operate said sear, and a latch to engage said sear point to prevent its release from the hammer."

This claim was rejected by the Patent Office on a reference to the patent to Borchardt, No. 571,260. The applicant thereupon amended the claim so as to read as it appears in the patent. The points introduced by the amendment, it will be perceived, consist in specifying the latch as being freely movable so as to engage said sear point, and the addition of the following element:

"A spring acting upon said latch to hold it normally in engagement with the sear-point and yielding to permit its release."

This claim relates to an arrangement for the purpose of locking the pistol, so that it cannot be fired without unlocking the pistol before the trigger is pulled. The latch has a projection which protrudes a little at the rear of and beyond the handle of the pistol. When the pistol is grasped in the hand for firing, the latch is moved in by the grip of the hand, and then by pulling the trigger the pistol is fired. Unless

the latch is moved in at the same time that the trigger is pulled, the pistol cannot be fired; the result being that the pistol cannot be accidentally discharged by dropping it, or by any ordinary accident.

I agree with the view of the Patent Office that the original claim as filed was anticipated by the patent to Borchardt. The only real difference between the safety device in the Borchardt patent and the safety device in the Browning patent consists in the fact that in the Borchardt patent the safety device is moved into a locking or unlocking position by a sliding latch situated on the side of and above the handle, in a position to be moved up and down by the thumb before or after firing. The practical difference between the two pistols, therefore, is that, in the Browning pistol, the unlocking of the safety latch is done automatically by the grip of the hand in the act of firing, and as soon as the hand is removed from the handle of the pistol the latch returns on a spring to its previous position; whereas, in the Borchardt pistol, there must be an intentional movement of the safety latch before firing in order to permit it to be fired, and after firing in order to lock the pistol again. Mr. Livermore, the complainants' expert, admits that:

"The substantial and important difference between the safety mechanism or device of the Borchardt pistol on the one hand, and the pistol of the Browning patent or defendant's pistol on the other hand, is that the Borchardt safety device is of the nonautomatic class."

It is obvious, and the evidence shows, that for certain uses there are great advantages in having the unlocking action automatic, so that the pistol, by the mere grip upon it in the act of firing, is made ready to fire. But claim 14 makes no claim of invention in or reference to the fact that the complainants' device acts automatically. Automatic devices of the kind are old. Various guns and pistols have arrangements for unlocking the gun by the grip of the hand in firing, as in the patents to Wesson, Dufour, Schluter, and others. In the Smith & Wesson patent, for instance, there is the same device for automatic action by the grip of the pistol that there is in the complainants' pistol, and all that would be necessary, in the Borchardt pistol, instead of having the safety device moved up and down by the thumb before or after firing, would be to have the safety device moved by the Smith & Wesson projection coming out at the rear of the handle. In my opinion, there is no invention involved in such a combination. If there had been, it was not claimed in claim 14.

The only addition to the claim made by its amendment consists in the statement that the latch was freely movable, and in the added element of a spring acting upon said latch to hold it normally in engagement with the sear point and yielding to permit its release. I see no point in the statement that the latch is freely movable. All the latches in such devices are. I think it doubtful whether the use of the spring amounts to invention. All such devices use springs. The only possible novelty in the Browning spring is that one spring acts at once upon the sear and the latch, instead of a separate spring acting upon each. But in any event, if the spring in the complainants' pistol is a novelty, the defendant does not use it, and does not infringe it.

Claims 37, 38, and 39 of patent No. 730,870 are as follows:

"37. In recoil-firearms having movable barrels, the combination of the rearward-moving barrel with linked levers, a stud or projection at the bending or 'knee' point of the linked levers and a curved guide-surface of the casing located in the path of the said projection, which in consequence of the recoil after firing is pressed against the said surface, substantially as shown and described.

"38. In a recoil-operated magazine-gun, the combination, with the receiver or casing, of a recoiling or sliding barrel, a breech-closing instrumentality, and two upwardly-breaking toggle-links connecting the said instrumentality with the recoiling or sliding barrel; the rear link of the two toggle-links being provided at a point forward of its rear pin with a surface for engagement with a surface upon the receiver or casing for lifting and unlocking the links during the rearward excursion of the recoiling or sliding barrel.

"39. In a recoil-operated magazine-gun, the combination, with the receiver or casing, of a recoiling or sliding barrel, a breech-closing instrumentality, and two upwardly-breaking toggle-links connecting the said instrumentality with the recoiling or sliding barrel; one of the said links being provided at a point forward of the rear pin of the rear link with a surface for engagement with the said surface upon the receiver or casing, for lifting and unlocking the links."

All the things referred to in these claims are admittedly old, except the particular point at which the force is applied for breaking the linked levers or toggle-joints. Recoil firearms are old. Such firearms having movable barrels are old. The combination of the rearward-moving barrel with linked levers or toggle-links is old. In the complainants' gun, the arrangement for breaking the toggle-links consists of a stud or projection at a point forward of the rear pin of the rear link, with a curved guide-surface for engagement with it upon the receiver or casing, for the purpose of lifting or unlocking the toggle-links. The use of toggle-links, for the purpose of opening the breech and enabling the shell of the exploded cartridge to be ejected and a new cartridge to be inserted in the gun for firing, is old. The Borchardt pistol shows the precise operation of the toggle-links in the complainants' gun, with the exception that, in the Borchardt pistol, the leverage for breaking the toggle-links is applied in the rear of the rear pin, instead of at a point forward of the rear pin. But the application of a breaking force at or near a point forward of the rear pin appears in various other designs for toggle-links, as, for instance, in the Smith & Wesson patent, the Von Skoda patent, and others. A great many methods of applying the leverage to break the toggle-links appear in the evidence, and in the state of the art at the time of the Browning application it involved no invention, in my opinion, to apply the force for the purpose of breaking the toggle-links at any particular point of them.

My conclusion is that there should be a decree in favor of the defendant, dismissing the bill on the merits, with costs.

FAIRCHILD v. DEMENT et al.

(Circuit Court, N. D. Illinois, E. D. August 4, 1908.)

No. 27,857.

1. CANCELLATION OF INSTRUMENTS—FRAUD—SUFFICIENCY OF EVIDENCE.

Evidence considered, and held insufficient to authorize a decree for the cancellation of written contracts on the ground of fraud, under the rule that in such case it must be sufficient to sustain a verdict convicting defendant of obtaining property by false pretenses.

2. SPECIFIC PERFORMANCE—CONTRACTS ENFORCEABLE—CONTRACT TO ASSIGN INVENTIONS.

A written contract by which the assignor of a patent agreed to convey to the assignee any future inventions made by him relating to the device of the patent or to improvements thereon is not in violation of public policy, and may be specifically enforced, where necessary to secure to the assignee the value of the patent purchased.

In Equity.

Selden Bacon and Arthur W. Underwood, for complainant.

L. W. James and Charles Turner Brown, for defendant Dement.

Walter Ayer, for defendant American Mechanical Cashier Company.

KOHLSAAT, Circuit Judge. This is a bill for specific performance of certain contracts by which, it is alleged, defendant Isaac S. Dement became bound to assign to complainant, Fairchild, certain inventions and improvements in the device of patent No. 618,932, granted February 7, 1899, for mechanical cashier. Defendant denies complainant's right to the relief prayed, and files a cross-bill, alleging want of consideration, fraud, imposition, and misrepresentation in the procurement of said contracts, and prays for their rescission and cancellation, and that the court may decree the reconveyance of certain patents and inventions transferred by him thereunder to Fairchild, and through Fairchild to the American Mechanical Cashier Company, codefendant.

Although the main issues are simple, the case is somewhat complicated, and the record voluminous, owing to the number of contracts and dealings of the parties covering a period of several years. The following facts are uncontroverted:

In 1895 defendant and cross-complainant, Isaac S. Dement, with one Charles F. Bassett, having invented a mechanical cashier, applied for a patent, and while their application was pending, in order to handle their invention commercially, caused to be organized the Mechanical Cashier Company (of Michigan), to which they assigned all their rights to the application and invention, covenanting by the same instrument to sell and transfer to said company any and all further, other, and different improvements and devices of or in regard to mechanical cashiers which they or either of them might from time to time invent or devise. In consideration of this assignment and contract Dement and Bassett each received \$48,000 of the stock of the Michigan Company, and Messrs. Tower, Sinclair, and McGarry, who had organized the company, received \$32,000 of stock, making a total issue of that

company's stock of \$128,000. Nearly four years afterward, in the spring of 1899, negotiations were entered into by Dement and his associates, through a broker by the name of W. C. Johnson, for the sale of the rights of the Michigan Company under its assignment and contracts, and on June 20, 1899, these negotiations culminated in a contract for the purchase of the patent by Fairchild, and a collateral agreement for the employment of Dement to work on the production of a perfected machine under the patent as an employé of complainant. By this contract Fairchild simply stepped into the shoes of the Michigan Company, succeeding to all its rights in the patent; it being provided in the contract that the assignment to be made to Fairchild should—

“cover and include all the right, title, and interest of [the Michigan Company] in and to any other, further, or different improvements, extensions, or reissues relating to mechanical cashiers which it has acquired or may hereafter acquire.”

The purchase price agreed to be paid by Fairchild was \$135,500 and a royalty of \$10 on each machine manufactured. During negotiations which led up to this sale, the broker, Johnson, exhibited to Fairchild what purported to be a contract between himself and the Michigan Company, by which the Michigan Company authorized Johnson to sell the patent for \$125,000 net to the company, Johnson to receive as his compensation everything obtained for the patent above the \$125,000, and this contract with Johnson was annexed as an exhibit to the contract of sale to Fairchild of June 20, 1899. It now appears that this supposed contract with Johnson was not the true agreement between the parties, but that it was one prepared to show to Fairchild. The real agreement was that Johnson should have everything above \$75,000, instead of \$125,000. About this time it appears that McGarry and Dement, then president and secretary of the Michigan Company, entered into an agreement with Johnson by which the price paid by Fairchild was to be divided as follows: \$75,000 to the Michigan Company; \$10,500 to A. L. Barber, in satisfaction of certain claims asserted by him; \$10,000 to Johnson; and some small amounts to Foster and Lynn. The rest of the cash was to be divided as follows: One half to Johnson, one fourth to McGarry, and one fourth to Dement; and the royalty reserved in the contract was to be given one third to Johnson, one third to McGarry, and one third to Dement.

The collateral agreement between Fairchild and Dement, made at this time, provided for the employment of Dement by Fairchild at a salary of \$100 per week during the construction of the sample machines, and also during the further construction of 1,000 machines by Fairchild, and for the further employment of Dement for 10 years at a salary of \$6,000 per year. Dement, besides agreeing to perform the required services, agreed to pay the entire expense of constructing the sample machines above his own salary and \$2,500, which he undertook to do within four months, and it was also agreed by him that he—

“would give to said Fairchild or his assigns in the construction of said sample machines, and said 1,000 machines, the benefit of all improvements, inventions,

and discoveries made by said Dement of recording and registering devices for use in connection with said mechanical cashiers" and "that all improvements, inventions, and discoveries made by him during every period of such employment upon or relating to mechanical cashiers or attachments thereto, or upon or relating to machinery for their manufacture or construction, shall be the property of his employer at the time of making such improvement, invention, or discovery, and that he will upon demand of his employer, but at such employer's expense and cost, take out patents thereon, which patents shall be duly assigned to and be the property of such employer."

Dement thereupon entered upon the manufacture of the 10 sample machines. He was not able to put together a satisfactory machine in 4 months as agreed by him; in fact, at the expiration of 21 months there was no such machine. About this time Mr. Bacon, counsel for Mr. Fairchild, had an interview with Dement on Fairchild's behalf, which resulted in a modification of the provision for a 10-year employment of Dement. This contract is in writing, dated April 6, 1901, and was signed by Dement. Fairchild paid in the neighborhood of \$30,000 in the endeavor to get a satisfactory model machine, but without entire success.

During 1900, 1901, and 1902 Dement separately, and also in conjunction with Arthur D. King and with Foster J. Hull, made a number of inventions relating to mechanical cashiers. These were all assigned to Fairchild. Immediately after the purchase of the patent by Fairchild, in June, 1899, he had caused to be organized the National Mechanical Cashier Company (of West Virginia), to which he assigned all his rights. Other companies were organized in the endeavor to dispose of the patent, all of which were afterwards abandoned, and their rights transferred to the codefendant in the present case, the American Mechanical Cashier Company (of New Jersey).

Prior to the organization of the New Jersey Company Fairchild had entered into negotiations with Dement (in April and May, 1901) to secure all his interests in the royalty and in the Michigan Company. The result was an agreement, dated May 25, 1901, that Dement should assign these interests to a representative of Fairchild in consideration of the transfer to him of \$40,000 of the stock of the then proposed corporation. Some time during the summer of 1901 Fairchild employed Dement to negotiate with McGarry for the interests of McGarry in the Michigan Company and the royalty, and for the interests of Sinclair and Tower. These negotiations resulted in an agreement with McGarry, and another with Sinclair and Tower, similar to that made by Dement. On the 4th of January, 1902, Dement signed a contract conveying to Fairchild the rights to his invention and improvements for all countries outside of the United States of America.

Dement now claims that his contract of April 6, 1901, by which he released his right to a 10-year term of employment, was without consideration. Fairchild says it cost him \$30,000 during this employment of Dement, and even then he did not get the sample machine promised. He worked 21 months, instead of 4 months. These undisputed circumstances, and the contract itself, seem to be a sufficient answer to this contention. Moreover, Dement seems never to have questioned the validity of this contract until this suit was commenced. There

seems to be no shadow of evidence that he was in any way imposed upon. The parties were dealing at arm's length, and he was, so far as the record shows, as well advised and as capable of taking care of his interests as Fairchild.

The principal dispute in the present case, however, is in regard to what the new company was to hold; Dement contending that it was to have, not only the rights as transferred originally by the Michigan Company to Fairchild, but also the royalties which were reserved at that time, and which were afterwards acquired by him, as well as the foreign rights which he acquired by the contract of January 4, 1902—in fact, everything that was transferred to Fairchild or his representatives during the negotiations, extending over a period of several years—while Fairchild insists that it is entitled only to the original rights of the company, subject to a royalty (which he had personally acquired and transferred to his wife).

Fairchild bases his right to the royalties and foreign rights, which he or his assigns hold apart from the company, by virtue of several contracts in writing signed by Dement. These on their face give him a clear title to the rights he is now asserting. These contracts did not, except in a few instances, show the consideration, and Dement testifies that they were signed upon the representations that the royalties and foreign rights were to be transferred by Fairchild or his representatives to the new company. Dement swears that conversations were had in which Fairchild told him that everything was to go to the new company. Fairchild flatly denies that any such conversations were had. The question presented is, therefore, one principally as to the veracity of these two witnesses. In many particulars Fairchild is corroborated by his counsel, Mr. Bacon, also a witness. The contracts on their face are clear, and, if Dement is to be charged with knowledge of everything contained in the papers he has signed, it is difficult to believe that such conversations were actually had.

Dement was a practical business man. There is no evidence of want of mental capacity or undue influence. That he had considerable skill in negotiating is abundantly proven. In his first connection with Fairchild he prepared a pretended contract to be "shown to the purchaser," and another real contract "to be settled by." No satisfactory explanation is made of his division of the original purchase price paid by Fairchild. The transaction looks very much like a diversion of the Michigan Company's assets. With the rightness or wrongness of these dealings the court is not now concerned. But it is difficult to consider this evidence without feeling strongly that Dement was not a man who would be likely to sign contracts recklessly without considering their effect. Moreover, Dement was a court reporter of many years' experience. He must have seen many cases fail for want of evidence. He must have known the weakness of such evidence as now produced on his behalf to establish a contract. He says he signed arms' full of papers for Fairchild—almost got in the habit of signing every time he saw Fairchild's attorney. Why he did not insist that some of these papers should show that Fairchild was to hold for the new corporation is hard to understand.

Cross-complainant's case thus rests almost entirely upon his own testimony, and his story is in every material particular denied by complainant. On this showing he asks a decree of cancellation and rescission of contracts conveying his foreign rights and royalties. He also asks that certain assignments of patents or applications may be set aside and reconveyance decreed. The rule as to what showing should be made to warrant the court in granting such relief is clearly laid down in *Atlantic Delaine Co. v. James*, 94 U. S. 207, 24 L. Ed. 112, and the same language is repeated in *Union Railroad Co. v. Dull*, 124 U. S. 174, 8 Sup. Ct. 437, 31 L. Ed. 417:

"Canceling an executed contract is an exertion of the most extraordinary power of a court of equity. The power ought not to be exercised, except in a clear case, and never for an alleged fraud, unless the fraud be made clearly to appear; never for alleged false representation, unless their falsity is certainly proved. * * *

And it has been held that, in order to authorize a court of equity to set aside a contract for fraud, such a case must be made out as would authorize a jury to convict the defendant of obtaining property under false pretenses. 18 Enc. Pl. & Pr. p. 75, citing *Henshaw v. Bryant*, 5 Ill. 97, and *Lloyd v. Brewster*, 4 Paige (N. Y.) 541, 27 Am. Dec. 88. Under this rule the evidence in the present case is manifestly insufficient to authorize the court to grant a decree of rescission and cancellation.

The bill prays the specific enforcement of the contract to convey future inventions, some of which have been made the subject of patents or applications for patents. That there is no public policy forbidding such contracts is well settled. *Westinghouse Air Brake Co. v. Chicago Brake & Mfg. Co.* (C. C.) 85 Fed. 787, and cases cited. In a case like the present one damages would be wholly inadequate. If the contract of purchase of the original patent is to be of any value to the purchaser, he must have what he bargained for. The contracts on their face give him the rights he asks. In the opinion of the court they have not been successfully attacked.

Defendant insists that the transactions were unconscionable in character, and that Dement is not only deprived of his inventions, but is now prevented from earning a living at his profession by persons who cannot and will not give him employment themselves. But a court cannot make contracts for the parties. How much of an advantage Fairchild has by his contracts does not clearly appear. If the manufacture of the machine cannot be made successful, his contracts will do him little good. In parting with his various rights, Dement was just as capable, so far as the evidence discloses, of judging their prospective value as Fairchild. It is very likely that Dement contemplated future employment by the new company, and that conversations were had about the matter as Dement testifies; but it is beyond reason to suppose that either of the parties contemplated such employment unless the new company could be made a commercial success; indeed, his contract of April 6, 1901, left this an open question. So that the court cannot seize upon the fact that Dement is not given employment as a ground for withholding the relief prayed. The case

is not one where there is such a shocking inadequacy of consideration that the court may presume fraud.

A decree may be prepared granting the prayer of the bill.

UNITED STATES v. GRASER-ROTHE.

(Circuit Court, S. D. Ohio. August 21, 1908.)

No. 6,266 (1,977).

1. CUSTOMS DUTIES — CLASSIFICATION — GRANITO — "WASTE" — "CRUDE MINERAL."

So-called granito or terrazo, produced by crushing the waste of marble quarries and sifting or sorting it into various sizes, is subject to classification as an unenumerated manufactured article, under Tariff Act July 24, 1897, c. 11, § 6, 30 Stat. 205 (U. S. Comp. St. 1901, p. 1693), rather than as "waste," under section 1, Schedule N, par. 463, 30 Stat. 194 (U. S. Comp. St. 1901, p. 1679), or as minerals "crude," under section 2, Free List, par. 614, 30 Stat. 199 (U. S. Comp. St. 1901, p. 1685).

[Ed. Note.—For other definitions, see Words and Phrases, vol. 8, pp. 7406-7408, 7833.]

2. WORDS AND PHRASES—"MANUFACTURED."

Where marble waste, a comparatively valueless material, has been converted into a commodity of use and value by a special manufacturing process, whereby it has acquired a new name and use, it ceases to be a "crude" mineral, and becomes a "manufactured" one.

[Ed. Note.—For other definitions, see Words and Phrases, vol. 5, pp. 4344-4346; vol. 8, p. 7716.]

On Application for Review of a Decision by the Board of United States General Appraisers.

The decision of the Board of General Appraisers (G. A. 6,631; T. D. 28,289) sustained the protest of M. A. Graser-Rothe against the assessment of duty by the surveyor of customs at the port of Cincinnati. The opinions filed by the board read as follows:

Fischer, General Appraiser. The merchandise consists of crushed marble, upon which duty was assessed at the rate of 10 per cent. ad valorem, under the provisions of Tariff Act July 24, 1897, c. 11, § 1, Schedule N, par. 463, 30 Stat. 194 (U. S. Comp. St. 1901, p. 1679), as waste not specially provided for. The importer in his protest contends that the merchandise should be admitted free of duty under section 2, Free List, par. 614, 30 Stat. 199 (U. S. Comp. St. 1901, p. 1685), as "minerals, crude, or not advanced in value or condition by refining or grinding, or by other process of manufacture, not specially provided for." The invoices describe it as "terrazosteine," and we find that it is also called "terrazo" and "granito." It is the waste from marble quarries, crushed in a machine and sifted or sorted into various sizes.

This merchandise has merely been crushed, and not ground. "Crushing," as defined by the Standard Dictionary, consists of breaking into bits by pressure, whereas the same authority defines "grinding" as a reduction to fine particles or powder by crushing or friction; the first being simply a reduction in size, while the other is reducing to a powder or pulverizing. Stone which has simply been crushed by machinery or otherwise has been repeatedly held not to be manufactured; and the board has held in numerous decisions that this article is entitled to free entry under paragraph 614 of the present act and similar provisions under previous acts. Note G. A. 5,573 (T. D. 24,938); G. A. 2,785 (T. D. 15,391); G. A. 2,343 (T. D. 14,551); Abstract 4,091 (T. D. 25,867); Abstract 7,773 (T. D. 26,655); Abstract 10,547 (T. D. 27,223); Abstract 12,634 (T. D. 27,572).

The classification of this merchandise as waste is a stultification of the government's contention; for, if the article be waste it is clearly not a manufactured article, and clearly cannot be an article advanced in value or condition by a process of manufacture. The sifting or sorting is merely an operation similar to that of jigging in the case of ores, and it does not change the crushed stone from its unmanufactured state. This crushed stone is therefore not a manufactured article, and has not been advanced in value or condition by refining, by grinding, or by other process of manufacture.

Following the rulings above cited, we sustain the protests and reverse the decision of the collector in each case.

Howell, General Appraiser (concurring). Inasmuch as the commodity here in question has been the subject of decision by this board on several occasions during the past three years, and has in every instance been held to be entitled to free entry under the provisions of paragraph 614, I am constrained to concur in the conclusion of my colleagues that these protests should be sustained. Unembarrassed by the previous rulings, I should reach a different conclusion.

In my judgment it is unnecessary to discuss the question as to whether or not there be any such distinction as that which my colleagues attempt to make between grinding and crushing, though I think there is very little difference between them, for one of the definitions of "grinding" is to crush into small fragments. If it be admitted, however, that the article has not been advanced in value and condition by grinding, it certainly has been so advanced by "a process of manufacture," which is sufficient to take it out of paragraph 614.

The article is produced from the waste of marble quarries. The testimony shows that this waste, which is practically valueless commercially, is ground or crushed in a machine specially made for the purpose, and that it is assorted or separated into sizes by passing the crushed marble through sieves or screens of various sized mesh. In this condition, which is the condition in which it is imported, it is known as "granito" or "ferrazo," and is worth from \$10 to \$12 per ton. It is used with cement in making mosaic floors. The merchandise as imported has therefore been converted from a comparatively valueless article into a commodity of use and value by a process of manufacture specially designed for the purpose. Labor and machinery have been used in producing it, and because of the manufacturing process it has acquired a new name and new use. It is therefore no longer a crude mineral, but is a manufactured article. *Hartman v. Wiegmann*, 121 U. S. 609, 7 Sup. Ct. 1240, 30 L. Ed. 1012; *Schriefer v. Wood*, 5 Blatchf. 215, Fed. Cas. No. 12,481; *Stockwell v. U. S.*, 3 Cliff. 284, Fed. Cas. No. 13,466; *Erhardt v. Hahn*, 55 Fed. 273, 5 C. C. A. 99; *In re Gardiner (C. C.)* 72 Fed. 494.

In the *Erhardt* Case, *supra*, the Circuit Court of Appeals for the Second Circuit said: "It has been repeatedly decided under the tariff acts that where an article has been advanced through one or more processes into a complete commercial article, known and recognized in the trade by a specific and distinctive name other than the name of the material, and is put into a completed shape designed and adapted for a particular use, it is deemed to be a manufacture."

The *Gardiner* Case, *supra*, also seems to me to be directly in point. In that case the court held that bones which had been crushed and screened were no longer crude bones, which were specially provided for in paragraph 511 of the act of 1890 (Act Oct. 1, 1890, c. 1244, § 2, Free List, 26 Stat. 604), but were to be regarded as a manufactured article. The pertinent portion of the paragraph under consideration in that case reads as follows: "Bones, crude, or not burned, calcined, ground, steamed, or otherwise manufactured." The court (McKenna, Circuit Judge), in referring to this paragraph, said: "It appears to regard bones which are burned, calcined, or ground as manufactured. If so, the words 'otherwise manufactured' would include those crushed and screened; and it is conceded that the bones in controversy are crushed and screened."

In the case at bar the marble has been ground or crushed in a machine specially made for the purpose, and then screened, and by these processes a comparatively valueless article has been converted into an article of con-

siderable value, with a distinct name and use in the trade and commerce of the country. This, I think, clearly takes the merchandise out of the purview of paragraph 614, which, under the decision in the Erhardt Case, is to be limited "to minerals in a state of preparation for manufacturing uses before they have reached the condition of a manufactured article." The commodity in question is certainly advanced beyond the stage of a crude mineral. It is marble advanced from a crude state through the application thereto of skilled labor. It is, however, still "marble," and not an article "made up of marble" (United States v. Dudley, 174 U. S. 670, 19 Sup. Ct. 801, 43 L. Ed. 1129), and is therefore not dutiable as a manufacture of marble under paragraph 115 (Tide-Water Oil Co. v. United States, 171 U. S. 210, 18 Sup. Ct. 837, 43 L. Ed. 139).

In my opinion the article is properly dutiable at 20 per cent. ad valorem under the provision in section 6, 30 Stat. 205 (U. S. Comp. St. 1901, p. 1693), for "all articles manufactured, in whole or in part, not provided for in this act." *Worthington v. Robbins*, 139 U. S. 337, 11 Sup. Ct. 581, 35 L. Ed. 181; G. A. 4,921 (T. D. 23,028).

Sherman T. McPherson, U. S. Atty.

THOMPSON, District Judge. I agree with General Appraiser Howell that:

"The merchandise as imported has been converted from a comparatively valueless article into a commodity of use and value by a process of manufacture specially designed for the purpose. Labor and machinery have been used in producing it, and because of the manufacturing process it has acquired a new name and a new use. It is therefore no longer a crude mineral, but is a manufacturéd article."

It is dutiable at 20 per cent. ad valorem under the provision in section 6, for "all articles manufactured, in whole or in part, not provided for in this act." See *Tariff Act July 24, 1897, c. 11, 30 Stat. 205* (U. S. Comp. St. 1901, p. 1693).

ROYAL SALES CO. v. GAYNOR et al.

(Circuit Court, S. D. New York. September 22, 1908. On Rehearing,

October 6, 1908.)

1. COPYRIGHTS—SUBJECT OF COPYRIGHT—MONOGRAM.

Defendant copyrighted a book describing a monogram used on a campaign badge, which was sold pinned to the book, and assigned the copyright, which was subsequently acquired by complainant. *Held*, that the copyright did not cover the monogram, which was not a subject of copyright.

[Ed. Note.—Matter subject to copyright, see note to *Cleland v. Thayer*, 58 C. C. A. 273.]

2. COURTS—FEDERAL COURTS—JURISDICTION.

Where plaintiff sues to enjoin the infringement of an alleged copyright by the person who assigned the same to him, but the matter was not subject to copyright, he cannot claim that defendant, as assignor, was estopped from alleging that the federal court had no jurisdiction because the copyright which he sold did not cover the matter in question, and where there is no requisite diversity of citizenship his bill will be dismissed.

On Rehearing.

3. SAME.

Where the jurisdiction of a federal court in a suit depends entirely upon the alleged infringement of a copyright, and the thing so alleged to be infringed is not within the copyright laws, no estoppel on the part of defendant to deny such fact can confer jurisdiction.

Duncan & Duncan, for the motion.
Robert W. Hardie, opposed.

WARD, Circuit Judge. September 14, 1908, an order to show cause why a preliminary injunction should not issue in this case was granted, returnable on the 15th, and on that day the defendant filed a demurrer to the bill, and also answering affidavits. The demurrer and motion were argued together, and as the question in dispute will cease to be of the slightest importance to either party after election day, November 3d, it is desirable to determine their rights at once. I will not discuss the many questions arising under the demurrer, because the disposition which I feel compelled to make of the motion would be the same, were the bill amended to cover all objections.

The bill is filed solely upon the copyright assigned by the defendant Gaynor to the complainant's assignor. It is for a book entitled which describes a monogram composed of the letters "T A F T," and explains the many names, words, phrases, and ideas associated with Mr. Taft which are abbreviated in it, of which a list is given; that it also contains the initials of Mr. Roosevelt; the cross, the emblem of Christianity; the mystical number, 7; and the important words, "You" and "I." Badges of the design of the monogram are sold pinned to the booklet.



Taft
Four Years

The defendant Gaynor after this sale copyrighted another booklet, called "Republican Platform Planks," and is selling pinned with it a badge in the form of the monogram described in the first copyrighted booklet. I am satisfied from the affidavits that Gaynor, who is a registered attorney in the Patent Office, assured the complainant and its assignor that the copyright which he was selling did cover the making and selling of this monogram; that all parties understood the chief, if not the sole, value of the transaction was in the exclusive right to make, use, and sell the monogram in the present presidential campaign; and that Gaynor, in making and selling a similar badge with his subsequent copyrighted booklet, is acting in bad faith.

The complainant contends that Gaynor, as assignor, is estopped from alleging that the copyright which he sold does not cover the monogram and the making of the badges in question, citing *Marvel Co. v. Pearl* (C. C.) 114 Fed. 946, and *Hurwood Manufacturing Co. v. Wood* (C. C.) 138 Fed. 835. In those cases the patents expressly covered the subject in dispute, and the court held that the defendant, as assignor, was estopped from saying in the first case that the patent did not, and in the second from so narrowly construing his own specifications as to destroy or impair what he had sold.

But the copyright under consideration is for the book, and not for the monogram, and I think the monogram is not a subject within the

copyright law. If it were, any one could get, by means of a copyright, what would be substantially a patent for a design for a longer term and upon payment of less fees than Rev. St. U. S. 4929-4933 (U. S. Comp. St. 1901, pp. 3398, 3399), prescribes in the case of design patents. Therefore the estoppel upon Gaynor depends, if at all, upon general principles of equity, and cannot give the court jurisdiction in this case, in the absence of the requisite citizenship of the parties. It is as if one were to ask the court, in a suit brought upon a patent for a machine, to enjoin because of his assignor's bad faith in the publication of a book. The complainant's remedy, if any, must be sought in the courts of the state.

The motion is denied.

On Rehearing.

At the request of complainant's counsel I have received additional briefs from the parties and have reconsidered the case, but without coming to a different conclusion. The complainant has cited many decisions relating to estoppel upon assignors of patent rights, but in every one the subject-matter involved was within the patent law. In this case the booklet was copyrighted, which no doubt covered everything it contained which was a subject-matter of the copyright law. The validity of the copyright is not questioned; but the monogram was not a "cut, print, or engraving," the only words of the copyright law appropriate to it, because it was not a pictorial illustration "connected with the fine arts," as required by Act June 18, 1874, c. 301, § 3, 18 Stat. 79 (U. S. Comp. St. 1901, p. 3412). If a copyrighted book contained a cut of an ordinary coffee mill or kitchen range, it would be no infringement to reproduce the cut or actually to make the article. The jurisdiction of the court depends solely upon copyright, and no estoppel upon defendants can extend its jurisdiction to a subject not within the copyright law.

Motion for rehearing denied.

In re GLICKMAN & PISNOFF.

(District Court, E. D. Pennsylvania. September 22, 1908.)

No. 2,755.

BANKRUPTCY—DISCHARGE—EXTENSION OF TIME FOR FILING APPLICATION.

A petition filed by a bankrupt more than a year after the adjudication, asking an extension of time for filing an application for discharge on the ground that he was unavoidably prevented from filing it within the year allowed therefor, is not evidence of the facts therein alleged, and on a reference of such petition they must be sustained by proof, although no formal answers may be filed thereto.

In Bankruptcy. On report of referee on petition to extend time for filing application for discharge.

Bernard Harris and William F. Berkowitz, for bankrupts.
Charles F. Stilz and Wessel & Aarons, for creditors.

J. B. McPHERSON, District Judge. The adjudication in this case was entered on March 11, 1907, but no application for a discharge was made until June 29, 1908. On that day a petition was presented to the court setting forth that the bankrupts had been—

“* * * unavoidably prevented from filing an application for discharge within 12 months from such adjudication, for the following reasons:

“(1) That on the 26th day of October, 1907, they signed a petition for discharge at the office of their attorney, said copy being hereunto attached, but at that time being unable to pay for the costs of advertising said notices of application for discharge, and of paying the postage necessary to send notice of the application for discharge to the various creditors, the matter remained in abeyance until the 22d day of June, 1908, when your petitioners appeared at the office of their attorney, and it was then discovered that the application for discharge had not been filed; and it was due in a great measure to oversight on the part of counsel for the petitioners that their attention had not been called to the necessity of filing said application within the 12 months from the date of the adjudication; and, furthermore, your petitioners were not in a position to pay the necessary costs prior to the 22d day of June, 1908.”

The court thereupon sent the petition to the referee, instructing him to give at least 10 days' notice to all known creditors of the application of the bankrupts for leave to file their petition for discharge, and report to this court the action of the creditors thereon, and his recommendation at his earliest convenience. The action of the referee in obedience to the order of the court will appear by the following extract from his report, which was filed on August 12, 1908:

“Pursuant to said reference, I gave 10 days' notice to all known creditors of the bankrupts that a meeting would be held at my office, No. 701 Arcade Building, Philadelphia, on the 23d day of July, 1908, at 3 o'clock p. m. The above-named meeting was held at the time and place mentioned in said notice, and at the said meeting I was attended by one creditor and by two attorneys; one representing two firms of creditors, and one representing a single creditor. The creditor who appeared in person was indifferent, but was, however, willing that the application should be granted. One of the attorneys, representing two firms of creditors, opposed the application, and the other attorney stated he was not authorized to take any stand either for or against the application. The bankrupts themselves failed to appear. Their counsel asked for a continuance on the ground that he had not expected any opposition, and the bankrupts were without the jurisdiction. The referee did not consider that a legal ground for continuance, and therefore, refused the same.

“With respect to applications, the bankrupts were apprised more than 10 days in advance of the date set for the meeting of the time, place, and purpose for which the meeting was to be held. It was their duty to have been present and to have submitted themselves to examination with respect to the averments contained in their application. They had no right to anticipate that there would be no opposition, and to absent themselves. Meetings should not be multiplied without proper cause, thereby consuming unnecessarily the time both of the referee and the creditors. In addition to this, it does not appear from the petition that the petitioners were unavoidably prevented during the whole of the period in which the application for discharge should have been made. The ground alleged therefor is that on the day on which they signed the petition for discharge they were unable to pay the costs of advertising. The petition could have been filed without any payment whatever, and it does not appear from the petition that the bankrupts were unavoidably prevented from paying the costs of advertising on any other than 26th day of October, 1907. The petition is therefore defective. In re Harris and Algor (D. C.) 15 Am. Bankr. Rep. 705, 117 Fed. 575.

“And inasmuch as no testimony has been offered by the bankrupts, or either of them, to supply the above deficiency, the referee respectfully recommends that the prayer of the petition be refused.”

This recommendation of the referee is objected to by the bankrupts on the ground "that the petition filed should have been taken as a verity, unless an answer was filed by opposing creditors, and that there was no necessity for the bankrupts to appear or give testimony unless such an answer were filed, and the prayer of the petition should have been granted." In my opinion the objection is not well taken. The petition required no answer. It merely asks the court for an extension of time within which to file the bankrupts' application for discharge, and it did no more than furnish a basis for the court's order, committing the subject-matter of the petition to the referee for examination and report. When the referee notified all parties to appear at a specified time and place, it became the duty of the bankrupts to obey the notice, and to sustain the burden that rested upon them, and this required proof that they had been unavoidably prevented from asking for a discharge within the year. Upon this subject the ex parte averments of their petition were not competent evidence.

Having failed, therefore, to establish the only statutory ground upon which an exception of time can be granted, the recommendation of the referee was fully justified. The petition of the bankrupts is accordingly refused.

In re GREEK MFG. CO.

(District Court, E. D. Pennsylvania. September 23, 1908.)

No. 2,971.

BANKRUPTCY—ORDERS OF REFEREE—MODE OF REVIEW.

Under general orders in bankruptcy No. 27 (89 Fed. xl, 32 C. C. A. xxvii), which provides for review of an order of a referee by the district judge on petition filed with the referee setting out the error complained of, such mode of review is exclusive, and a referee has no authority to review his own orders on exceptions thereto, nor is a party entitled to a review by the judge, except on a petition filed in accordance with such rules as may be adopted by the court.

In Bankruptcy. On certificate of referee concerning claim of National Cash Register Company.

George Wentworth Carr, for National Cash Register Co.
T. Henry Walnut, for objecting creditor.

J. B. McPHERSON, District Judge. At a meeting on April 20, 1908, the referee decided a dispute concerning the ownership of a fund produced by the sale of a cash register, and entered an order awarding the money to the bankrupt's trustee. It appears from the certificate that counsel for the National Cash Register Company was not present, and that the order was made without a full examination of the authorities. The certificate goes on to state that:

"Shortly after the entry of the order, the referee received a brief filed by the attorney for the cash register company, and upon its receipt and after a reargument entered the order complained of."

This second order, which is now under review, was entered on May 29th, and is attacked upon the ground that it was entered without au-

thority; the argument being that, as no petition to review the order of April 20th had been presented within the period required by the rule of court that applies to this subject, that order had become final. This objection raises a question of practice that should be settled.

General order 27 (89 Fed. xi, 32 C. C. A. xxvii) is in the following language:

"When a bankrupt, creditor, trustee, or other person shall desire a review by the judge of any order made by the referee, he shall file with the referee his petition therefor, setting out the error complained of, and the referee shall forthwith certify to the judge the question presented, a summary of the evidence relating thereto, and the finding and order of the referee thereon."

This method of reviewing an order is exclusive; but it will be observed that no time is fixed within which the petition must be filed with the referee. How long the time shall be is therefore left to be regulated by the courts as they may think proper, and they have agreed that unless a rule upon this subject has been adopted a reasonable time is sufficient. In this district the practice since December 10, 1904, has been governed by the following rule:

"Unless the petition be afterwards allowed by a judge of the District Court for cause shown after notice to opposing interests, a review of any action or order of a referee must be asked for by petition presented to him before the expiration of the tenth day after such action is taken or order is made, with this exception, namely: A review of the admission or rejection of evidence, if such admission or rejection has been duly objected to at the time, may be asked for within ten days after the referee has filed his decision in the proceeding wherein the evidence was offered. Referees are instructed to disregard petitions for review when presented after the expiration of the period named, unless accompanied by an order of allowance from a judge of the District Court. Prompt notice of filing of decisions upon any subject shall be given by the referee to counsel interested."

The meaning of this rule seems to be sufficiently clear. Taken in connection with general order 27, it provides that an order once entered by a referee may only be reviewed by petition, and that such petition must be presented within the period specified by the rule, or afterwards upon special allowance by one of the judges. Otherwise the referee's order (unless, perhaps, when it is obviously beyond his jurisdiction) is no longer subject to review when the ten days thus limited has expired. It follows, also, that an order once entered is not subject to be reviewed or altered by the referee himself. To permit this would be to enlarge general order 27 so as to include what the Supreme Court did not see fit to insert, namely, "the referee," as well as "the judge"; and I need not say that such enlargement is beyond the power of a District Court. The practice (which has, to some extent, grown up in this district) of filing exceptions to a referee's order, which are thereupon argued and determined at such time as may be fixed, is merely a method of having the referee review his own ruling, and finds no warrant either in the general order or in the rule of the District Court. The general order requires that the petition for review shall "[set] out the error complained of," and by this means the same result is reached as by filing exceptions. Occasionally such practice may conveniently afford the referee the opportunity of correcting an inadvertence or a plain mistake; but, even when this is

true, the correction may ordinarily be made by the judge with as much convenience and as little loss of time. In the great majority of cases the filing of exceptions is followed by a rehearing that does not change the referee's opinion, and a review by the court is therefore delayed, without any corresponding advantage; but in any event the practice appears to be irregular, and should be discontinued.

The order of May 29th was entered without authority, and is hereby stricken off.

BARNES et al. v. PIERCE.

(Circuit Court, S. D. New York. September 23, 1908.)

TRADE-MARKS AND TRADE-NAMES — UNFAIR COMPETITION — INJUNCTION — GROUNDS—INJURY TO BUSINESS.

The manufacturer of an antiseptic, to which he gave the artificial name "Argyrol," held entitled to an injunction to restrain defendant, a jobbing druggist, from placing argyrol on his price list and supplying customers who called for the same with a different and cheaper preparation in its place.

Robinson, Biddle & Benedict (Mr. Benedict, of counsel), for complainants.

Herbert H. Maass, for defendant.

WARD, Circuit Judge. This is a motion for preliminary injunction. The affidavits show that the complainants manufacture an antiseptic under the artificial name "Argyrol," which has attained considerable popularity. It is not complained that the defendant, who is a jobbing druggist, imitates this name or the complainant's package.

March 25, 1908, one Caton having presented a written order for "argyrol" at defendant's store, his clerk said: "We don't keep argyrol. We keep nucleinate of silver, which is the same thing"—and he handed the purchaser a price list, on which was printed "\$1.20 oz. argyrol."

March 28, 1908, one Bagg presented a prescription at the defendant's store which called for "one oz. argyrol." The clerk handed him a bottle marked "1 oz. silver of nucleinate." Bagg asking him whether he had not made a mistake, the clerk replied, "Well, you can take it or leave it," whereupon Bagg said, "I want to be sure this is argyrol, because I don't want to have to come downtown again." The clerk replied, "That is probably what the doctor wants," and made out a receipt for "1 oz. S. Arg." Bagg said: "You have billed this wrong. You have written it '1 oz. S. Arg.,' and it should be 'Silver of Nucleinate,' as labeled on the bottle." The clerk replied: "It doesn't make any difference. We used to bill it differently, but now we bill it 'Silver Arg.'"

March 11, 1908, Richard D. and Marcie Dunn presented an order blank from a Brooklyn chemist for "argyrol." The clerk said: "I can give you 'silver of nucleinate.'" Dunn asked: "Is this the same stuff as 'argyrol,' which the order calls for?" The clerk replied: "I don't know. I don't put it up. We have it in the hands of the lawyer now, but we have the right to call it 'argyrol'. Argyrol is \$1.85, and

this is \$1.20; and you will save money by buying this. You can take it to the druggist, and if it isn't right you can bring it back." He signed a receipt: "1 oz. Silver Nucleinate. \$1.20."

June 3, 1908, one Rourke called for "2 oz. of argyrol." The clerk gave him a bottle labeled "Silver Nucleinate." The defendant personally entered the office, and the clerk remarked to Rourke and explained to defendant that Rourke was a New Jersey druggist. Rourke picked up the bottle and said: "What is this?" The clerk replied: "This is the same thing as 'argyrol.' That is the chemical name. That is 'argyrol.' It is the same thing."

The defendant states in his verified answer and in his affidavit that he has never carried argyrol or offered the same for sale. The fact that he does print it on his price list as sold for \$1.20 an ounce, much lower than argyrol is sold, seems consistent only with his intention to do the very thing the complainant alleges, viz., to offer the public argyrol at less than the market rates and then deliver to purchasers nucleinate of silver as argyrol.

The affidavits show that the chemical composition of the two articles is not the same, and, even if it were, the defendant would have no right to deliver nucleinate of silver to a purchaser asking for argyrol without an explanation. It is true that explanations were made to Dunn, Bagg, and Rourke; but they had demurred, and, if they had not, I think none would have been made. If the defendant were selling nucleinate of silver, saying that it was as good or better than argyrol, or that it was the same as argyrol, if that were the fact, the complainants would have no ground for objection.

The cases relied upon by the defendant (*Goodyear's India Rubber Glove Manufacturing Co. v. Goodyear Rubber Co.*, 128 U. S. 604, 9 Sup. Ct. 166, 32 L. Ed. 535; *Canal Co. v. Clark*, 13 Wall. 327, 20 L. Ed. 581; *French Republic v. Saratoga Springs Vichy Co.*, 191 U. S. 427, 24 Sup. Ct. 145, 48 L. Ed. 247; and *Saxlehner v. Wagner* [C. C. A.] 157 Fed. 745) only hold that words which are public either in their nature, as (with certain qualifications) geographical names, and names which, though private property, have become public by abandonment or laches, such as "Goodyear's Rubber," "Hunyadi," and "Vichy," cannot be monopolized by any one. This does not apply to the artificial word "Argyrol," or justify the defendant in inviting the public to buy argyrol of him and delivering nucleinate of silver in its place. *Enoch Morgan's Sons Co. v. Wendover* (C. C.) 43 Fed. 420, 10 L. R. A. 283.

Motion granted.

UNITED STATES v. DELAWARE & H. CO.

(Circuit Court, E. D. Pennsylvania. September 10, 1908.)

Nos. 85, 87, 89, 91, 95, and 97, in Equity.

Nos. 202, 204, 206, 208, 212, and 214, at Law.

1. CONSTITUTIONAL LAW — INTERSTATE COMMERCE — POWER OF CONGRESS TO REGULATE.

The power of Congress under the commerce clause of the Constitution to regulate interstate and foreign commerce is limited by the other provisions of the Constitution, and among them that of the fifth amendment, that no person shall be deprived of life, liberty, or property without due process of law; and the validity of a statute enacted in the assumed exercise of such power may be challenged on the ground that it is in violation of such provision.

2. SAME—CONSTITUTIONALITY OF STATUTE—COMMODITY CLAUSE OF INTERSTATE COMMERCE ACT—"REGULATION OF INTERSTATE COMMERCE."

The "commodities clause" of the interstate commerce act (Act Feb. 4, 1887, c. 104, 24 Stat. 379 [U. S. Comp. St. 1901, p. 3154]), as amended by Act June 29, 1906, c. 3591, 34 Stat. 584 (U. S. Comp. St. Supp. 1907, p. 894), which makes it unlawful for any railroad company to transport in interstate or foreign commerce any article or commodity, "other than timber and the manufactured products thereof, manufactured, mined or produced by it or under its authority, or which it may own in whole or in part, or in which it may have any interest, direct or indirect, except such articles or commodities as may be necessary and intended for its use in the conduct of its business as a common carrier," is not a regulation of interstate commerce, within the commerce clause of the Constitution, but entirely excludes from such commerce a certain class of persons, and is unconstitutional and void as applied to railroad companies which, under the sanction and encouragement of state laws, had more than 50 years before its enactment become the owners of coal lands in such state, and by themselves, or subsidiary companies of which they owned the stock, developed mines thereon, and constructed railroad lines thereto at great expense, and engaged extensively in the mining of coal, a large part of which was necessarily marketed in other states, and which could not practically be transported, except over their own lines, nor marketed within the state, as depriving such companies of their liberty and property without due process of law, in violation of the fifth constitutional amendment.

3. COMMERCE—POWER OF COURTS TO DETERMINE VALIDITY OF STATUTE.

The power to regulate interstate commerce is a distinct and substantive power granted to Congress by the Constitution, subject to the limitations thereof, and is not the equivalent of the reserved police powers of the states, which must always remain indefinite in character and incapable of classification or definition; but an enactment in the assumed exercise of such power, like one by a state under its police powers, is reviewable by the courts to determine whether it is within the power granted as so limited by the Constitution itself, and a legitimate and reasonable exercise thereof.

4. SAME—LIMITATION OF POWER OF CONGRESS.

The power of Congress under the commerce clause of the Constitution to regulate interstate commerce does not include the power to entirely exclude from such commerce an article or commodity which is a legitimate and useful subject of commerce, and not inimical to public safety, health, or morals, save when, and because, it is the property of a certain class of owners.

Buffington, Circuit Judge, dissenting.

Bills in equity and petitions for mandamus on behalf of the United States against the Delaware & Hudson Company, the Erie Railroad Company, the Central Railroad of New Jersey, the Delaware, Lackawanna & Western Railroad Company, the Pennsylvania Railroad Company, and the Lehigh Valley Railroad Company. Bills dismissed, and petitions for writs of mandamus denied.

Charles J. Bonaparte, Atty. Gen., and T. C. Spelling, and L. Allison Wilmer, Sp. Asst. Attys. Gen., for the United States.

James H. Torrey, James M. Beck, and Wm. S. Opdyke, for Delaware & H. Co.

George F. Brownell and Adelbert Moot, for Erie R. Co.

Jackson E. Reynolds and Robert W. de Forest, for Central R. R. of N. J.

John L. Seager and W. S. Jenney, for Delaware, L. & W. R. Co.

Francis I. Gowen, George V. Massey, and John G. Johnson, for Pennsylvania R. Co.

Frank H. Platt and J. F. Schaperkotter, for Lehigh Valley R. Co.

Before DALLAS, GRAY, and BUFFINGTON, Circuit Judges.

GRAY, Circuit Judge. There have been filed in this court on behalf of the United States, by the Attorney General thereof, six bills in equity against the railroad corporations, defendants respectively, as named in the cases set forth in the caption—the Delaware & Hudson Railroad Company and the Erie Railroad Company being corporations by and under the laws of the state of New York; the Central Railroad Company a corporation by and under the laws of the state of New Jersey; and the Delaware, Lackawanna & Western Railroad Company, the Pennsylvania Railroad Company and the Lehigh Valley Railroad Company, corporations by and under the laws of the state of Pennsylvania. There were also filed at the same time, on behalf of the United States, at the relation of the said Attorney General, under the authority of the act of Congress, entitled "An act to regulate commerce," approved February 4, 1887, and of acts amendatory thereof, petitions for mandamus against the said defendants respectively. Both the bills in equity and the petitions for mandamus are founded upon the same acts in alleged violation, or threatened violation, by the defendants respectively, of one of the provisions of section 1 of the said act to regulate commerce, approved February 4, 1887 (Act Feb. 4, 1887, c. 104, 24 Stat. 379 (U. S. Comp. St. 1901, p. 3154)), as amended June 29, 1906 (Act June 29, 1906, c. 3591, 34 Stat. 584 [U. S. Comp. St. Supp. 1907, p. 894]), the said provision being as follows:

"From and after May first, nineteen hundred and eight, it shall be unlawful for any railroad company to transport from any state, territory, or the District of Columbia, to any other state, territory, or the District of Columbia, or to any foreign country, any article or commodity, other than timber and the manufactured products thereof, manufactured, mined, or produced by it, or under its authority, or which it may own in whole, or in part, or in which it may have any interest direct or indirect except such articles or commodities as may be necessary and intended for its use in the conduct of its business as a common carrier."

These charges of violations of this so-called "commodities clause" are, as we have said, the same in the bill in equity as in the petition for mandamus against each defendant. It is, in substance, charged in the bill and petition against each defendant, that it operates, and has been operating, long prior to the said 8th day of May, 1906, a railroad or railroads in and through the anthracite coal fields of the state of Pennsylvania, and into New Jersey, New York and other states, and, as a common carrier through all said period, has been engaged in interstate transportation of the article or commodity known as anthracite coal, from the mines and mining lands in the state of Pennsylvania to the said other states; that as to some of said defendants, the coal so transported has been in large measure owned, in whole or in part, by them, either through purchase, or as being the product of their own mines and coal lands. It is also charged in each of said bills and petitions, that the defendant has been engaged during the period aforesaid in the interstate transportation of coal, in which it had an interest, direct or indirect, by reason of its ownership of the stock of other companies owning or mining and producing the coal; and generally, that by continuing such interstate transportation of said coal, as aforesaid, each defendant has acted in violation of the said "commodities clause," by so transporting an article or commodity, other than timber and the manufactured products thereof, owned by said defendant in whole or in part, or in which it has or will have an interest, direct or indirect, or which has been mined or produced by it or under its authority, and which article or commodity is not necessary or intended, and will not be necessary and intended "for its use in the conduct of its business as a common carrier."

Each bill seeks to enjoin the defendant therein from further transporting in interstate commerce the anthracite coal, which it alleges it is the purpose of said defendant to transport, as thereinbefore stated, and each petition for mandamus prays for the issuance of an alternative writ, commanding and directing the defendant therein to forthwith and hereafter comply with the provisions of the law hereinbefore quoted, by forthwith and thereafter ceasing and refraining from transporting in interstate commerce, as therein alleged, the anthracite coal which, as is alleged, it is the purpose of the defendant to transport, or to appear and show cause, etc.

To these several bills and petitions, answers have been filed by the defendants therein, respectively. In these answers, it is admitted, generally, by the defendants, that the allegations in the bills and petitions as to their corporate existence, are true, and that they own or operate railroads engaged in the interstate transportation of coal from the anthracite region of Pennsylvania. They also admit that this transportation has been carried on by the several defendants long prior to the 8th day of May, 1906, and in the case of some of them, for a period varying from a quarter to more than half a century prior thereto. In addition to these general admissions, detailed statements are made by the defendants, respectively, of the character and extent of the ownership or other interest possessed by them in the coal so trans-

ported, or in the lands or mines from which it is produced. It is only necessary to briefly summarize these statements:

(1) The Delaware & Hudson Company alleges that it directly owns its coal lands as it does its railroad; that it was incorporated by an act of the Legislature of the state of New York, April 23, 1823 (Laws 1823, p. 305, c. 238), and was "authorized to construct a canal or water navigation from the anthracite coal district in Pennsylvania to the Hudson river in New York; to purchase lands in Pennsylvania containing stone or anthracite coal; and to employ its capital in the business of transporting to market coal mined from such lands." That this authority was also expressly conferred by acts of the Legislature of the state of Pennsylvania, between the years 1823 and 1871, and that these acts of the state of Pennsylvania resulted from the desire and policy of said state to create and foster the industry of mining such coal and developing the transportation thereof; that under the authority of these statutes of Pennsylvania and of New York, the said defendant, beginning as early as the year 1825, invested its capital in the purchase of a large quantity of coal lands in the state of Pennsylvania and in the construction of canal navigation in Pennsylvania from the Delaware river to the Hudson river; that later, under statutes of both states, it invested additional capital in the construction of railroads in the state of Pennsylvania, and in the construction and acquisition of railroads and leasehold estates in the state of New York, for the same general purpose of transporting coal from the coal lands owned by it; that it has invested large sums of money, not only in the acquisition of coal property, but in the erection of structures for mining and terminal facilities; that some of its coal properties were acquired under leases upon royalties payable to the lessors for each ton of coal mined, the leases fixing large minimum amounts by way of rent; that large fixed rentals are required to be paid, not only for those mining lands but for railroads acquired for the purpose of transporting coal; that there are three coal companies whose shares are practically all owned by it, viz., the Northern Coal & Iron Company, the Jackson Coal Company, and the Hudson Coal Company; that its mining lands thus owned and acquired are located upon or contiguous to the railroads of defendant; that said railroads are the only reasonable, practical, and conveniently available avenues of transportation whereby the coal by it produced can be transported in interstate commerce and the coal mined by the defendant and by said coal companies upon its lines of railroad amounts approximately to 70 per cent. of the entire transportation by it, or to about 4,300,000 gross tons, its daily shipments averaging about 12 trains of 37 coal cars each; that the coal lands so acquired by the defendant and by said three coal companies would have little, if any, value, except for the mining of coal therefrom and its sale as a commercial commodity, and that if it is deprived, by virtue of the said act of Congress, of the right to transport said coal, it will be deprived of the only possible enjoyment of its property. It further avers that it is not a "railroad company" within the meaning of the act of Congress, but that it is a coal company, and that since the year 1870 it has become, incidental-

ly to its business as a coal mining company, a common carrier by railroad of passengers and property.

It is further averred, as a special ground of defense by the said Delaware & Hudson Company, that this said "commodities clause" does not apply to it, because all the coal mined by it upon its own lands, and upon the lands of the said three coal companies (except as to steam sizes, as thereafter stated) "is sold, before transportation thereof begins, by said company to third persons at the mines in Pennsylvania from which such coal has been produced, and that said company does not, at the time when the same is so transported by it in interstate commerce, own the same nor any interest therein, direct or indirect, apart from its obligation and rights as a common carrier in the transportation thereof, and that it carries said coal for the account of the purchaser thereof, who is the consignor and owner of said coal."

(2) The answer of the Erie Railroad Company states that it was originally organized under the laws of the state of New York, in 1832 (Laws 1832, p. 190, c. 129); that it has been reorganized from time to time under mortgage foreclosure, and finally, in November, 1895, under a foreclosure sale, it was reorganized under the statutes of New York, whereby it "became the lawful owner of the property, rights, privileges, immunities and franchises of all its predecessors aforesaid, including the shares of capital stock of coal companies and of railroad companies, as well as the railroads theretofore held and possessed by said predecessor companies, the railroads so owned by it and its said subsidiary companies having an aggregate mileage of over 2,100 miles in the states of New York, Pennsylvania, New Jersey, Ohio, Indiana and Illinois"; that the Pennsylvania Coal Company was created a corporation by the laws of Pennsylvania, in 1838 (P. L. 1837-38, p. 434, § 14), its charter giving it the right of "transacting the usual business of companies engaged in mining, transporting to market and selling coal and the other products of coal mined," and for that purpose, it was given the power to purchase or lease coal lands in Pennsylvania; also the power to construct railroads with one or more tracks. In 1853 (Act March 15, 1853 [P. L. 196]) the said Pennsylvania Coal Company was authorized to extend its railroad to connect with the New York & Erie Railroad. The right of said Pennsylvania Coal Company to buy coal lands and build railroad connections was continued by acts of the Legislature of Pennsylvania, in 1857 (Act March 10, 1857 [P. L. 72]), 1864 (Act April 14, 1864 [P. L. 430]), 1867 (Act April 2, 1867 [P. L. 670]), and 1868 (Act April 14, 1868 [P. L. 1082]); that in pursuance of these various acts of the Legislature, the Pennsylvania Coal Company obtained capital, issued stock therefor, acquired coal lands, developed coal mines, produced, transported to markets, and sold coal, built and operated railroads, made railway connections, as authorized, and did other like acts to promote the business of supplying all persons needing the same with anthracite coal. The Hillside Coal & Iron Company was organized by an act of the Legislature of the state of Pennsylvania, in 1869 (Act April 12, 1869 [P. L. 1312]), for the purposes and with powers similar

to those of the Pennsylvania Coal Company. Under authority of acts of the Legislature of Pennsylvania, the said Erie Railroad Company, long prior to the passage of the said amendment to the interstate commerce act, acquired substantially all the capital stock of said Pennsylvania Coal Company, the Hillside Coal & Iron Company, the Jefferson Railroad Company and Erie & Wyoming Railroad Company, and a small minority of the stock of the Temple Iron Company, and has pledged the same under various mortgages, pursuant to which have been issued and are now outstanding, bonds for large sums, aggregating many millions of dollars, which bonds are held by purchasers in good faith and for value throughout the world; that for many years prior to May 1, 1908, it has been engaged in transporting the coal of said corporations to markets outside the state of Pennsylvania, many of which can only be reached from the railroad lines of this defendant; that the coal so transported amounts annually to several millions of tons and constitutes 22 per cent. of the entire freight tonnage of this defendant, the Erie Company. It also denies that it is, by reason of the ownership of said stock in said companies, the owner in whole or in part of the coal transported by it in interstate commerce, or that it has or had any interest, direct or indirect, therein, and therefore has not violated or failed to comply with the so-called "commodities clause" of the interstate commerce act.

(3) The Central Railroad Company of New Jersey avers that it was organized under the laws of the state of New Jersey, and by these laws was authorized to purchase and hold the stock or securities of any other corporation, of New Jersey or elsewhere, and that it was also so authorized by two acts of Assembly of the state of Pennsylvania, one of which, approved April 15, 1869 (P. L. 31), was entitled "An act to authorize railroad and canal companies to aid in the development of coal, iron, lumber, and other material interests of this commonwealth"; that pursuant to the authority of these several acts, it had, long prior to the said act of Congress, become the owner of a majority of the shares of the capital stock of the Honeybrook Coal Company and of the Wilkes-Barre Coal & Iron Company, both companies now being merged into the Lehigh & Wilkes-Barre Coal Company, a large majority of whose shares are owned by it; that it also owns a minority of the shares of the Temple Iron Company; that in 1871, it became the lessee of the Lehigh & Susquehanna Railroad, a Pennsylvania corporation, which it has ever since operated under an obligation to pay a yearly rental of not less than \$1,414,400 and not to exceed \$2,043,300 per annum; that its gross earnings from the transportation of coal amounted, for the year ending June 7, 1907, to \$9,312,268.04, being 48 per cent. of its entire freight receipts, and that a large part of its earnings from freight and miscellaneous passenger traffic is incident to and dependent upon the operation of the mines and collieries of said coal companies, and that the greater part of its earnings from transportation of coal comes from its carriage of the coal mined by the Lehigh & Wilkes-Barre Coal Company, and that large sums of money have been expended by it in extending its

lines and in constructions to enable it to transport said coal in interstate commerce.

(4) The Delaware, Lackawanna & Western Railroad Company, like the Delaware & Hudson Company, admits that it is the owner of coal lands, and mines coal which it sells; that it was organized under an act of the Legislature of Pennsylvania in 1849 (Act Feb. 19, 1849 [P. L. 79]); that all the lines of railroad owned by it, are wholly within the state of Pennsylvania, extending from the Delaware river, at the boundary line of the state of New Jersey, in a northwesterly direction across the state of Pennsylvania, to the boundary line between the state of Pennsylvania and the state of New York, with a branch line extending from Scranton, in the state of Pennsylvania, to Northumberland in said state. Said defendant also admits and alleges that, under express authority of acts of the Legislatures of the states of Pennsylvania, New Jersey and New York, it, as lessee, now operates, and long prior to May 1, 1908, had operated, various lines of railroad in the two last mentioned states, by which it has direct traffic connection with the city of Buffalo and other cities in the said states. Defendant also admits that for many years it has owned, in fee, extensive tracts of coal land in the state of Pennsylvania; that it has also leased large tracts of coal land in the said state, and is now engaged, and for many years last past has been engaged, in mining coal from the lands so owned and leased by it; that the holding of said lands, whether in fee or by lease, and the mining, manufacture and interstate transportation of the coal therefrom, has been and continues to be under and by virtue of the authority of the laws of the state of Pennsylvania; that in addition to the foregoing, certain coal companies, organized from time to time under acts of assembly of the said state of Pennsylvania, have been merged into said defendant corporation; that by an act of the General Assembly of the state of Pennsylvania, approved April 15, 1869, entitled "An act to authorize railroad and canal companies to aid in the development of the coal, iron, lumber, and other material interests of this commonwealth," the defendant was authorized to aid corporations authorized by law to develop coal, iron, lumber, and other material interests of Pennsylvania, by the purchase of their capital stock or bonds, or either of them. The answer of said defendant also alleges that, by reason of its ownership of said coal lands and coal, and the revenues derived from the transportation of the same to market, it has been enabled to expend millions in the betterment of its general transportation facilities for both goods and passengers, and give to the public the benefits of a well constructed and equipped modern railroad. That by virtue of leases of railroads, to enable it to transport coal in interstate commerce, it has become bound to pay yearly, in interest charges, the sum of \$5,155,697, and for taxes \$1,163,916. That out of a total of about 8,700,000 tons of coal produced by it in the year 1907 from its land owned in fee and leased, upwards of 6,700,000 tons were transported over its lines of railroad in interstate commerce; that from 40 per cent. to 60 per cent. of its annual transportation earnings, from the operation of leased lines, has been derived from the carriage of its own coal thereover. That

it uses, in the conduct of its business as a common carrier, approximately 1,700,000 tons of anthracite coal, of pea size or smaller, annually, and will require more for such use in the future; that to obtain this coal in these economic sizes, it is necessary to break up coal, leaving the larger sizes which must be disposed of otherwise; that great waste would result if it were forbidden to transport to market in interstate commerce these larger sizes thus resulting. That defendant's rights to acquire its holding of coal land, its rights to own and mine coal and to transport the same to market in other states as well as in Pennsylvania, and its leases of other railroads, were acquired many years prior to the enactment of the so-called "interstate commerce act," and of the said amendment thereto known as the "commodities clause."

(5) The answer of the Pennsylvania Railroad Company avers that it was incorporated under the laws of the state of Pennsylvania April 13, 1846 (P. L. 312); that as early as 1871, under authority of two general statutes of the state of Pennsylvania, it became the owner of all the shares of the Susquehanna Coal Company, of all the shares of the Summit Branch Mining Company, and of one-third of the shares of the Mineral Railroad Mining Company, corporations of the state of Pennsylvania; that since the last mentioned year, and up to the present time, it has carried the coals produced from the mines of the said coal companies, at lawfully established schedule rates, over its lines of railroad; that approximately 65 per cent. of the coal so mined has been carried to destinations outside the state of Pennsylvania; that it mines no coal, but that the coal it carries is mined by the said coal companies, and that it has no interest therein within the meaning of the said act of Congress, either direct or indirect; that the most largely producing of the properties belonging to these coal companies are located either directly upon, or so contiguous to the system of railroads operated by said defendant, as to render transportation by any other railroads not reasonably practicable.

(6) The answer of the Lehigh Valley Railroad Company states that it was originally incorporated September 20, 1847, under the laws of the state of Pennsylvania. Under the authority of various acts of assembly of the said state, other railroad and coal companies, prior to the year 1874, have been merged into it, some of which railroads were expressly authorized to construct railroads and to carry on the business of mining, transporting and vending coal. It is also the lessee of railroads in Pennsylvania; that by means of its own and of said leased lines of railroad, it conducts, and for many years has conducted, an interstate transportation of coal; that since 1872, pursuant to authority conferred by the laws of Pennsylvania, it has also owned the majority of the capital stock of the New York & Middle Coal Field Railroad & Coal Company, a corporation of the state of Pennsylvania; also the entire capital stock of Coxe Bros. & Co., a corporation of said state; a minority interest in the capital stock of the Highland Coal Company; a majority of the stock of the Locust Mountain Coal & Iron Company; a minority interest in the capital stock of the Packer Coal Company, and of the Temple Iron Company, all corporations of the state of Pennsylvania, organized for the pur-

pose of mining coal, some of them more than half a century ago; that it has constructed lines of railroad and branch railroads and terminal facilities, for the purpose of transporting to market, in interstate commerce, the coal of the companies whose shares it owns, and this business has been conducted by it for many years; that practically said coal can be transported to market only by its railroads; that the capital stock of two of the coal companies owned by said defendant has been transferred to a trustee, to hold under a general mortgage executed by defendant, under which mortgage bonds to the amount of \$23,539,000 have been issued by said defendant and are now outstanding in the hands of the public; that the capital stock of Coxe Bros. & Co., Incorporated, owned by this defendant as aforesaid, has been transferred and assigned to, and is now held by, a trustee under a collateral trust agreement executed by said defendant, dated November 1, 1905, for the purpose and upon the terms expressed in said agreement, a copy of which is annexed to said answer, and that bonds to the amount of \$18,000,000 have been issued under said agreement and are now outstanding in the hands of the public; that said defendant transports, annually, in interstate commerce, upwards of 7,600,000 tons of anthracite coal, shipped by the said coal companies whose stock is owned by said defendant, in whole or in part as aforesaid, and transports, annually, for said coal companies, wholly within the state of Pennsylvania, upwards of 1,500,000 tons; that nearly 42 per cent. of its gross annual earnings of \$36,068,431, for the last fiscal year, or \$15,110,899, were derived from coal freights, which represented over 51 per cent. of its entire freight tonnage; that the greater part of its gross earnings from coal transportation was received from the coal companies whose shares are by it owned; that the mines and collieries of said coal companies are all so located in the portions of the coal fields tributary to its lines of railroad, that no means of transporting their product can be made available, except by defendant's railroads; that the railroad lines of this defendant have been from time to time extended, the control of other railroads acquired, and its facilities and equipment increased at enormous expense, in reliance upon the rights and franchises conferred by the statutes of Pennsylvania aforesaid; that a very large part of defendant's earnings is derived from the freight and passenger traffic incidental to and dependent upon the operation of the mines and collieries of said coal companies, and that if said defendant were deprived of the earnings derived from the transportation of the coal of said coal companies, its business could not be continued, except at a net loss of many millions of dollars per annum.

These cases have all been submitted to the court upon the bills and answers in the cases in equity and the petitions and answers in the mandamus proceedings; the statements of fact, therefore, contained in these answers, must be taken to be true. There is no disagreement, however, as to any of the material facts, whether stated in the bills and petitions or in the answers, or as to those general facts of economic and industrial history of which judicial notice can be taken. The questions of law arising out of these facts, in each of the cases,

are of such a character that they were heard, and will now be considered, together. Some of the questions raised and stated in the answers are in a measure special and peculiar to individual cases, and arise out of the extent and character of the ownership, or of the interest, direct or indirect, existing as to the coal, which of course is the commodity here in question transported in interstate commerce.

The fundamental and underlying question, however, which presents itself at the threshold of all the cases for our consideration, is, whether the so-called "commodities clause," amendatory of the act to regulate commerce, passed June 29, 1906, so far as its scope applies by the universality of its language to the cases here presented, is in excess of the legislative authority granted to Congress by the Constitution. This question must be considered with reference to the Constitution as a whole, and in relation to the concrete facts of the several cases. It is therefore necessary to keep in mind the situation as presented by these defendants, the facts set forth in their individual answers, as above briefly summarized, and the relevant industrial conditions which, being matters of common knowledge, may be judicially noticed.

The general situation is, that for half a century, or more, it has been the policy of the state of Pennsylvania, as evidenced by her legislative acts, to promote the development of her natural resources, especially as regards coal, by encouraging railroad companies and canal companies to invest their funds in coal lands, so that the product of her mines might be conveniently and profitably conveyed to markets in Pennsylvania and in other states. Two of the defendant corporations, as appears from their answers, were created by the Legislature of Pennsylvania, one of them three-quarters of a century ago and the other half a century ago, for the expressed purpose that its coal lands might be developed and that coal might be transported to the people of Pennsylvania and of other states. It is not questioned that, pursuant to this general policy, investments were made by all the defendant companies in coal lands and mines, and in the stock of coal producing companies, and that coal production was enormously increased, and its economies promoted, by the facilities of transportation thus brought about. As appears from the answers filed, the entire distribution of anthracite coal in and into the different states of the Union and Canada, for the year 1905 (the last year for which there is authoritative statistics), was 61,410,201 tons; that approximately four-fifths of this entire production of anthracite coal was transported in interstate commerce over the defendant railroads, from Pennsylvania to markets in other states and Canada, and of this four-fifths, from 70 per cent. to 75 per cent. was produced either directly by the defendant companies or through the agency of their subsidiary coal companies. It also appears from the answers filed, that enormous sums of money have been expended by these defendants, to enable them to mine and prepare their coal and to transport it to any point where there may be a market for it. It is not denied that the situation thus generally described is not a new one, created since the passage of the act in question, but has existed for a long period of years prior thereto, and that the rights and property interests acquired by

the said defendants in the premises have been acquired in conformity to the Constitution and laws of the state of Pennsylvania, and that their right to the enjoyment of the same has never been doubted or questioned by the courts or people of that commonwealth, but has been fully recognized and protected by both.

To this situation, the complainant contends the fifth paragraph of the first section of the act to regulate commerce, as amended by the act of June 29, 1906, applies, and strikes with illegality the conduct by the defendants of this enormous business, as above described—a business harmless in itself, and of immense importance to the consumers of coal. We again quote this so-called “commodities clause”:

“From and after May first, nineteen hundred and eight, it shall be unlawful for any railroad company to transport from any state, territory, or the District of Columbia, to any other state, territory, or the District of Columbia, or to any foreign country, any article or commodity, other than timber and the manufactured products thereof, manufactured, mined, or produced by it, or under its authority, or which it may own in whole, or in part, or in which it may have any interest direct or indirect except such articles or commodities as may be necessary and intended for its use in the conduct of its business as a common carrier.”

The legislative will could hardly be expressed more unequivocally. There is no room for doubt as to the meaning and practical effect of the clause in question. By it, each of the defendants is forbidden to transport in interstate commerce any of the coal (a) “mined or produced” by it; (b) “mined or produced under its authority;” or (c) “which it may own in whole or in part;” or (d) “in which it may have any interest, direct or indirect; except such as is necessary or intended for its own use in the conduct of its own business.”

It results, therefore, that the coal described in the foregoing categories is outlawed in interstate commerce, and must remain so, unless the defendants can divest themselves of all title or interest in the coal, coal lands, or coal companies, from which the markets in other states have been so largely supplied. The enforcement of the act must, of necessity, result, either in the defendants holding their coal properties and refraining from transporting coal to other states, and confining themselves to the mining of such coal as may be used in the state of Pennsylvania, or in their divesting themselves of all title or interest, direct or indirect, in said properties, by sale or surrender thereof, as they may be able to accomplish the same. The population of the region outside of Pennsylvania, absolutely dependent upon the use of anthracite coal for domestic or industrial purposes, is very large, and has been, no doubt moderately, estimated at from 12,000,000 to 15,000,000. The adoption of the former alternative, therefore, would entail, while it continued, an amount of suffering and deprivation that it is hard to forecast or appreciate, while the forced resort to the other would necessarily inflict upon the defendants and their stockholders, a most disastrous sacrifice and pecuniary loss.

That the enforcement of a law should result in loss and inconvenience to individuals, few or many, does not, of course, impugn the legislative authority to enact such law, but it may well serve to challenge the serious consideration, not only of the legislative body which enacts

it, but, of courts who are required to pass upon the question, whether indeed it be a valid law or not.

Congress, of course, is vested only with such legislative powers as are specifically enumerated in the Constitution, together with such as are necessary and proper to carry the same into execution, and it is admitted that, if constitutional sanction exists for the passage of the law in question, it must be found in that clause of the eighth section of article 1 of the Constitution, declaring that Congress shall have power "to regulate commerce with foreign nations, and among the several states, and with the Indian tribes."

Upon several grounds, counsel for defendants contend that the said "commodities clause" of the act of June 29, 1906, was not a valid exercise of the power conferred upon Congress by this clause of the Constitution. No other part of the Constitution has been the subject of more judicial consideration and discussion, and no other grant of power has been more frequently invoked to sustain legislation by Congress upon subjects affecting the conduct and business of the citizens of a state, and which theretofore had been left exclusively to state control. Much of this legislation has not only passed the scrutiny of the Supreme Court, but has been admittedly beneficial in its results. The importance and influence of the commerce clause of the Constitution has not only been felt in the direct legislation by Congress which it has authorized, but also in the restraint that it has placed upon state legislation, which has tended to affect or control interstate or foreign commerce.

It is not surprising, therefore, that with the growth of population and the increasing importance of the interstate business of the country, there should be an increasing frequency in the exercise by Congress of the power thus conferred, and the legislative records of Congress show a still greater frequency in the proposals for such enactments, which have failed to receive legislative sanction. These considerations serve to emphasize the importance of the duty devolved upon the courts, as well as upon Congress, to carefully compare every such enactment with the scope and intent of the constitutional power invoked therefor.

Fully appreciating the serious responsibility that is imposed upon the court in these cases, and recognizing fully the presumption of validity accorded to legislative acts, we turn to the question raised by defendants, as already stated, viz., whether the so-called "commodities clause," amendatory of the act to regulate commerce, passed June 29, 1906, is, so far as its scope applies by the universality of its language to the cases here presented, a constitutional and valid enactment,—one within the legislative authority granted to Congress by the Constitution.

Ample as is the scope of legislative power granted by the language of the commerce clause, and far as the Supreme Court has undoubtedly gone in sustaining the validity of legislation under it, we think it may be safely said that no assertion of this power hitherto, by Congress, has been so far-reaching, or affected in so serious a degree the individual liberty and property rights enjoyed under the Constitution

and laws of a state, as the enactment we are here considering. It is not to be denied that the right to carry in interstate commerce coal which they own in whole or in part, or which is mined or produced by them or under their authority, or by coal companies in which they are stockholders, was, until the passage of the act in question a lawful right of these defendants; that it was a common right of property, neither denied nor disputed by the common or statute law of Pennsylvania; that it was a most important property right, the enjoyment and exercise of which was neither criminal nor immoral, and subject only to any restraints imposed upon its possessors by the common or statute law of the state, or by the then existing statutes of the United States, so far as they were engaged in interstate commerce. If in any manner and to any extent whatever, they have actually violated the latter, surely they could be restrained, or otherwise made amenable to the legal penalties in such behalf, without crippling or destroying a business in which they are profitably and usefully engaged. We must, however, assume for the purposes of this discussion, in the absence of any assertion to the contrary, that these defendants have regularly complied with and conformed themselves to all the legal requirements of the interstate commerce law, touching the business in which they are engaged.

To these defendants, thus innocently and lawfully engaged in transporting coal which they own, or are interested in to the extent and under the circumstances hereinbefore set forth, comes this act of Congress, and declares that this whole business is unlawful, and that the future exercise of a vested right of ownership, which they have heretofore and for long periods of years enjoyed, under the belief that it was an ordinary right of property enjoyed innocently by all citizens of the state alike, and inviolable as such, is a crime, and punishable as such. That this legislation is drastic and harsh, does not, of course, dispose of the question of power on the part of Congress to enact it. Many laws, clearly within the legislative power to enact, may result incidentally in loss or inconvenience to individuals and to particular interests. The first inquiry to be made, therefore, is as to whether this legislation is a regulation of commerce, within the true meaning of the commerce clause of the Constitution. It is contended that the power to regulate commerce assumes the continued existence of the thing to be regulated, and does not include the power to destroy or inhibit it, at least if the commerce inhibited is not criminal, immoral, or injurious to public health, morals, or safety. If we pass for the present this contention, the question remains, whether this power is an absolute one, and without any limitation upon its exercise, other than the will of the legislative branch of the government.

It is impossible to consider this question, without recurring to the often quoted language of Chief Justice Marshall, in *Gibbons v. Ogden*, 22 U. S. 1, 6 L. Ed. 23, that:

"This power, like all others vested in Congress, is complete in itself, may be exercised to its utmost extent, and acknowledges no limitations other than are prescribed in the Constitution."

Further on, the Chief Justice, in speaking of the plenary character of the specific powers granted to Congress, said:

"The wisdom and discretion of Congress, their identity with the people, and the influence which their constituents possess in elections, are the sole restraints on which they have relied to secure them from their abuse."

This language is repeatedly quoted in the arguments and briefs on behalf of the government, in support of the contention that this power to regulate, etc., is in effect an unlimited and absolute one. But surely it would be unreasonable to suppose that the Chief Justice had in mind, as subject to abuse, any unlimited or absolute power, but only such power as it existed under the grant of the Constitution, carrying with it such limitations as might be inherent in its nature or be prescribed in the Constitution itself. "Plenary power" may exist within such limitations, and though clearly liable to abuse within its permitted bounds, such abuse can only be corrected through the control possessed by the people at the elections. To deduce from the language quoted, authority for this contention of the government, is to attribute to the great Chief Justice opinions contrary to his expressed understanding of our dual scheme of government, and constitute him a champion of an absolutism abhorrent to the genius and character of our institutions. The contention also ignores the qualifying language contained in the description of the power to regulate commerce, above referred to, where it says that "it acknowledges no limitations other than are prescribed in the Constitution." This extreme contention must also ignore the like qualifying language, when it quotes, as it does with great emphasis, from the same opinion, the statement that:

"The power over commerce * * * among the several states is vested in Congress as absolutely as it would be in a single government *having in its Constitution the same restrictions on the exercise of power as are found in the Constitution of the United States.*"

We have italicized these concluding words, because they express a clear recognition by Chief Justice Marshall of the fact that the Constitution itself places limitations on the power to regulate commerce, granted by it to the Congress. But, recognizing, as he does, that these limitations exist, he says in this connection, that they do not affect the questions then before the court, and for that reason they were not further considered, the sole question for consideration in that case being, whether the power given to Congress to regulate commerce was exclusive, or concurrent with a like power in the state of New York, by which it assumed to deprive citizens of other states of the right to navigate the navigable waters within the jurisdiction of said state.

We may assume, therefore, that the commerce clause of the Constitution is no exception to the general doctrine, that unlimited power has no place in American governmental institutions, and that there are rights of liberty and property that are secure against hostile legislative action. As has been well said:

"In a constitutional government, limitation is the abiding principle, exhibited in its highest form in the Constitution, as the deliberative judgment

of the people, moderating every claim of right or use of power." Prentice on Police Power.

No one can read the history of the formation of the Constitution, and of the conditions from which it sprang, without being impressed with the fact that the desire to preserve the individual right of the citizens of each state, to enjoy, untrammelled, that right of property which consisted in the ability to transport it into other states, free from the inhibitions and harassments that might theretofore have been imposed by the regulations of such other states, was one of the most important, if not the principal, of the impelling causes that brought about the Convention of 1787. In contemplating this history, the thought cannot be avoided that, in conferring upon Congress, and in denying to the states, this power of interstate regulation, it was meant to preserve, and not to destroy or impair, this important right of property so essential to its full enjoyment, and to the individual liberty of which it is a part.

These reflections are pertinent as a preparation for the inquiry, does the Constitution prescribe any limitation on the power of Congress, as asserted by the enactment in question, of which these defendants can lawfully avail themselves?

The first ten amendments to the Constitution were admittedly intended to prevent abuse of the powers granted to the general government, and of these, the fifth, among other things, provides:

"Nor shall any person * * * be deprived of life, liberty or property without due process of law, nor shall private property be taken for public use without just compensation."

These inhibitions serve as a limitation upon the exercise of federal power, whether legislative, executive or judicial, and it is not surprising that they should be invoked as a protection against any action of the federal government, supposed to be injurious or destructive of the rights thus protected. No more serious and responsible duty can be imposed upon this or any court, than of determining whether, as to any given assertion of its legislative will, Congress has or has not transcended the limitations of the Constitution. In the opinion of this court, the enactment in question is not a regulation of commerce, within the proper meaning of those words, as used in the commerce clause of the Constitution, and therefore not within the power granted by that clause. It never has been decided that the power conferred upon Congress to regulate interstate commerce may be so expanded by construction as to warrant the prohibition of such commerce under all circumstances; and to us it does not seem to be reasonably possible that it should be. Moreover, this power, whatever its scope, certainly is subject to the limitations contained in the Constitution, and this can be said with especial emphasis as to those limitations found in amendments adopted after the ratification of the Constitution. *Carroll v. Greenwich Ins. Co.*, 199 U. S. 401-410, 26 Sup. Ct. 66, 50 L. Ed. 246.

It seems perfectly plain, then, that Congress cannot, in the exercise or pretended exercise of any legislative power conferred upon it, deprive any person within its jurisdiction of his liberty or property, without due process of law, nor can it be questioned that, with the

possible exception of the war power, this is true, no matter under color of what power such deprivation is sought to be accomplished. No argument should be necessary, therefore, to show that this cannot be accomplished by an enactment in assertion of power under the commerce clause of the Constitution. Counsel for the government, however, contend that any enactment of Congress which purports to regulate interstate commerce, and which actually does control, restrain or prohibit the same, or some part thereof, is such an exercise of power under the commerce clause of the Constitution as is subject to no limitation whatever, and cannot be challenged by any person, on the ground that it is violative of the inhibitions contained in the fifth amendment. In other words, if it be on its face a regulation of commerce, no right of personal liberty or property can stand in the way of its enforcement, but, on the contrary, every such right is only held and enjoyed, subject to the will of Congress in the exercise of its power to regulate interstate commerce.

This is a startling proposition, but is, as we think will appear, a necessary premise to the conclusion contended for by the government. It is admitted, by counsel for the government, that it has never yet been directly asserted in any decision of the Supreme Court, but they contend that it is deducible from certain judgments of that court, and is necessary to that fullness and completeness of control over commerce, which, begging the question, they say it was the intention of the Constitution to grant. It may avail nothing to say that it has never heretofore been imagined that a power so formidable as this lay dormant in the Constitution, ready to be aroused and exercised at the arbitrary will or caprice of Congress, because it is true that, in the development of our modern life, clearly existing powers that have lain dormant, or have only been partially exercised, have been made applicable to conditions unforeseen by those who framed the Constitution, but in these cases, the powers invoked have clearly existed, and were not predicated upon the supposed exigencies for their exercise. The consequences of establishing such a proposition as one of constitutional law, may well be considered, if they be of such a character as to throw light on the intention of those who framed the Constitution, or to render it improbable that they ever meant to grant in the premises the absolute and unlimited power contended for.

It may be safely said, and we have before remarked, that the legitimate exercise of no legislative power granted by the Constitution, is capable of touching at so many points, and in such a variety of ways, the every day life and business of the citizen. It is easy to see, therefore, that if it be subject to none of the limitations of the Constitution, and especially if the constitutional guaranty of life, liberty and property are of no avail to the citizen, rights which we have considered as most sacred and most secure may be overthrown and destroyed wantonly or arbitrarily by the will of Congress, provided that will is manifested by a regulation of commerce. It is small comfort to those who hate arbitrary or despotic power, to say that when Congress, by an enactment, has deprived the citizen of liberty or property without due process of law, it was but expressing the will of their constituents.

We have, since the foundation of the government, rested secure in the belief that there are rights which the people themselves have placed beyond the power of governmental agencies, or of the majorities for the time being behind them, to impinge upon or destroy. The provision in the fifth amendment, declaring that no person shall be deprived of life, liberty or property without due process of law, would be a mere "rhapsody of words," without force or meaning, if so far-reaching and important a legislative power as the one we are discussing can be exercised without regard to its inhibition.

It does not detract from the force of these observations to recognize that, in the consideration and enforcement of these limitations, and of those on the states in the fourteenth amendment, the Supreme Court, as we shall presently see, has given to them that wise and common sense application to concrete cases, as they arose, as makes them consistent with, and not destructive of, the practical efficiency of the powers granted by the Constitution or reserved to the states. The Constitution of the United States was intended for the common understanding of the people. The plain and obvious meaning of the words employed are to be accepted, unless plain reason to the contrary appears in the text of the Constitution itself. Life, liberty and property are ranked together under the protection of the fifth amendment, and by the exigence of its command, a person can no more be deprived of his property than he can be deprived of his life or his liberty, without due process of law.

But, if the contention of the government be sustained, that, in regulating interstate commerce all the consequences, direct as well as indirect and incidental, that injuriously affect the property of a citizen, may be disregarded without respect to their character, the same must be true as to those consequences that affect his liberty. Indeed, the property rights of the citizen are a part of his personal liberty. So that, a regulation of interstate commerce, not merely affecting the mode or manner of transportation, but excluding from interstate transportation altogether certain classes of persons, or imposing conditions on such transportation as would wantonly and arbitrarily affect personal liberty, would have to be sustained, and even life itself might be put in peril without redress. Here again, it is not enough to say, as does the counsel for the government, either that it is an impossibility that Congress would proceed to such an extreme, or that those who so legislated would be thereafter rejected at popular elections. The amendment we are considering, makes it impossible for either Congress or their constituents to do any of these things, and the deprivation of life, liberty or property, without due process of law, is placed by the Constitution beyond the reach of majorities, as well as beyond the power of governmental agencies.

It is not denied that corporations are persons, within the provisions of the fifth, as well as of the fourteenth, amendment (*Gulf, C. & S. F. Ry. Co. v. Ellis*, 165 U. S. 150, 154, 17 Sup. Ct. 255, 41 L. Ed. 666), and in the cases before us, it is claimed that the enforcement of the provisions of the so-called "commodities clause" will violate this inhibition of the fifth amendment, as to these defendants, and that its

enactment is therefore invalid. The facts set forth in the several answers become pertinent and necessary to the proper consideration of this claim, and to them we must again refer.

We need not dwell upon the enormous aggregate of the property to be affected by this amendment. Each individual defendant is either the direct owner, or interested, directly or indirectly, in coal or coal lands to a very large extent, and it has owned these lands and possessed these interests, as we have seen, for long periods of years prior to the enactment of the clause in question. We need not repeat what we have already said, in regard to the harmless character of this ownership and these interests, but we can refer to the fact that some, if not all, of these defendants were invited and encouraged by the Legislature of the state of Pennsylvania to invest their funds in the coal land through which their respective railroads ran, and in the coal companies who owned and operated mines contiguous to such railroads, and that two of the corporations defendant were brought into existence by the Legislature of Pennsylvania—one of them three-quarters of a century ago and the other half a century ago—for the express purpose of developing the coal lands of the state, so that coal might be transported to the people of Pennsylvania and of other states. It is the interstate transportation of the property thus acquired and owned, that the enforcement of this act in the present proceeding seeks to enjoin and prevent.

The facts, set forth in the several answers of these defendants, abundantly show that no right of property of these defendants, in or to the coal owned by them, is so valuable or important as the right to transport it over their own roads. Every incident of this ownership and of this interest, as set out in the answers of the defendants, tends to enhance the value of this right. It must be accepted as a fact, that the coal from the mines thus owned or controlled, or in which these defendants have an interest, direct or indirect, is so situated as not to be capable of transportation, without enormous loss, by any other roads than those of the defendant owning it or interested therein. As we have before said, the exigence of the act will compel the defendants to cease mining and transporting such coal, while still retaining their ownership or interest therein, to the incalculable injury of the great populations depending upon the marketing of such coal, or, they will be compelled to surrender and divest themselves of title thereto by a compulsory sale of these coal lands and stock in coal companies. When we consider the magnitude of the sacrifice that must certainly attend such a sale, from throwing upon the market at once these properties, whose enormous aggregate value we have already referred to, it will be manifest that either alternative means a deprivation of property of enormous value by the mere command of the statute, without process of law or just compensation therefor. No refinement of argument or legal casuistry, if it were permissible in such a case, can conceal the loss directly inflicted by the enforcement of this statute, or make it anything else than a practical and substantive violation of the letter and spirit of the fifth amendment. To forbid the right to transport this commodity under the circumstances set forth in these cases,

is to deprive the larger part of the property owned or controlled by these defendants of a market, and therefore of its chief value. In such a situation, it boots little to say that the owner is not deprived of his mere title to the coal, when it has been stripped of its chief value in his hands.

Further argument is hardly needed to establish the conclusion that the necessary result of enforcing the "commodities clause" of the interstate commerce act will be to deprive the defendants of property, and likewise of their liberty as to transportation and disposition of a useful and harmless article of property—a liberty which they have always enjoyed in common with all the citizens of Pennsylvania, and under the protection of that commonwealth, and in accordance with the usages of its people and its public policies.

The gravamen of the argument on behalf of the government, as we apprehend it, may be stated as follows: Inasmuch as the same inhibition, as to depriving any person of life, liberty or property without due process of law, as is applicable by the fifth amendment to the federal government, is made applicable also to the states by the adoption of the recent fourteenth amendment, it follows that the decisions of the Supreme Court, which have exempted in certain cases the exercise of their police powers by the states from the inhibition of the fourteenth amendment, as being outside of the scope thereof, are in point, as showing that a like exemption from limitation should be accorded to the power of Congress to regulate interstate commerce. It is further argued that this power of Congress is the equivalent of the police power, as exercised by the states with reference to subjects within their jurisdiction.

The power to regulate commerce is a distinct and substantive power, granted to Congress by the Constitution, subject as we have seen to the limitations thereof. "It is complete in itself," like the other granted powers, while the police powers comprise that indefinite mass of powers reserved to the states and which inhere in all civil societies for the protection of the lives, health, morals, and public interests of their members. They have their origin in the law of necessity. There is no equivalency between them and the power to regulate commerce, which does not pertain to the other granted powers. The police powers reserved to the state must always remain indefinite in character and incapable of classification or definition, from the very variety and multiplicity of the matters with which they are concerned. As said by Mr. Justice Grier in the License Cases, 5 How. 632, 12 L. Ed. 256:

"As subjects of legislation, they are, from their very nature, of primary importance; they lie at the foundation of social existence; they are for the protection of life and liberty, and necessarily compel all laws on subjects of secondary importance, which relate only to property, convenience, or luxury, to recede, when they come in conflict or collision. * * * The exigencies of the social compact require that such laws be executed before and above all others. It cannot be supposed that the states intended, by adopting that amendment (the fourteenth), to impose restraints upon the exercise of their powers for the protection of the safety, health, or morals of the community."

See, too, *Mugler v. Kansas*, 123 U. S. 623, 8 Sup. Ct. 273, 31 L. Ed. 205.

When lawfully and properly enacted, their practical efficiency will not be interfered with, because they incidentally affect private property or interests. Their legitimate exercise cannot be brought within the purview of the life, liberty and property guaranties, either state or national. To do so, would tend to destroy the very foundations upon which the security of those inestimable rights of the citizen must rest. Of necessity, therefore, the courts have, from the beginning, been compelled in each case as it arose, to determine what was or was not a legitimate exercise of its police power by a state, and in doing so, to consider whether it was enacted in good faith and was calculated reasonably to accomplish any one or more of the objects within the purview of that power.

Of necessity, too, the courts must, in determining the challenged validity of any given exercise of its police powers by a state, consider the reasonableness of such exercise, in the light of the essential character of those powers, as above described, and determine whether they have "appropriate and direct connection with that protection to life, health and property which each state owes to her citizens." *Patterson v. Kentucky*, 97 U. S. 501, 506, 24 L. Ed. 1115. If not in direct collision with constitutional restraints, state or federal, courts will not allow indirect and incidental consequences of such exercise of the police power, to personal or property rights, to affect adversely the validity of the enactments. If, on the contrary, they are in such direct collision, or constitute a "palpable invasion of rights secured by the fundamental law, it is the duty of the courts to so adjudge and thereby give effect to the Constitution."

If this be so, it is apparent that the argument for the unlimited character of the power conferred upon Congress to regulate commerce, is not advanced by comparing it to the police powers reserved to the states. It would still be the duty of the courts to determine whether any challenged restriction of commerce by Congress, was a reasonable exercise of the power to regulate it, or constituted "a palpable invasion of rights secured by the fundamental law." The cases in the Supreme Court, involving such a consideration of the police powers reserved to the states, have been frequent, and some of those cited by counsel for the government require a brief consideration at our hands.

It is hardly necessary to do more than refer to the full discussion of the principles to which we have above alluded, contained in the elaborate opinion delivered by Mr. Justice Harlan, for the Supreme Court, in the comparatively recent case of *Mugler v. Kansas*, 123 U. S. 623, 8 Sup. Ct. 273, 31 L. Ed. 205, because the court in that case went as far as it has ever gone, in recognizing the rights of the states in the exercise of their police powers, by recognizing the right of Kansas to entirely prohibit the sale or manufacture of intoxicating liquors, and thereby, as was alleged, to destroy the value of the brewery of the plaintiff in error, notwithstanding the due process provision of the fourteenth amendment. But, in order to uphold the validity of the law of Kansas in this behalf, the court deemed it necessary to show that it did not invade the rights secured by the fourteenth

amendment, because it was a reasonable exercise of the police powers of the state. In demonstrating its reasonableness in this respect, this language of Mr. Justice Grier, in the License Cases, is quoted with approval:

"The true question presented by these cases, and one which I am not disposed to evade, is whether the states have a right to prohibit the sale and consumption of an article of commerce, which they believe to be pernicious in its effects, and the cause of disease, pauperism and crime."

After stating at some length the well-known facts in regard to the pernicious character of the traffic in intoxicating drinks, Mr. Justice Harlan says:

"There is no justification for holding that the state, under the guise merely of police regulations, is here aiming to deprive the citizen of his constitutional rights; for we cannot shut out of view the fact, within the knowledge of all, that the public health, the public morals, and the public safety, may be endangered by the general use of intoxicating drinks; nor the fact established by statistics accessible to every one, that the idleness, disorder, pauperism, and crime existing in the country are, in some degree at least, traceable to this evil."

And it cannot be supposed, he says, that the states intended by the fourteenth amendment to impose restraints upon the exercise of their powers for the extirpation of such evils. While it belongs to the legislative department of the states to determine primarily what are appropriate or needful exercises of their police powers, it belongs to the courts to finally determine on the reasonableness of such exercise. Though the Kansas law in question was properly found by the court, for the reasons stated, to be a valid exercise of its police powers, Mr. Justice Harlan says that the following principles must be kept in view, "as governing the relations of the judicial and legislative departments of government with each other":

"It does not at all follow that every statute enacted ostensibly for the promotion of these ends, is to be accepted as a legitimate exertion of the police powers of the state. There are, of necessity, limits beyond which legislation cannot rightfully go. While every possible presumption is to be indulged in favor of the validity of a statute (*Sinking Fund Cases*, 99 U. S. 700, 718, 25 L. Ed. 496), the courts must obey the Constitution rather than the law-making department of government, and must, upon their own responsibility, determine whether, in any particular case, these limits have been passed. 'To what purpose,' it was said in *Marbury v. Madison*, 1 Cranch, 137, 176, 2 L. Ed. 60, 'are powers limited, and to what purpose is that limitation committed to writing, if these limits may, at any time, be passed by those intended to be restrained? The distinction between a government with limited and unlimited powers is abolished, if those limits do not confine the persons on whom they are imposed, and if acts prohibited and acts allowed are of equal obligation.' The courts are not bound by mere forms, nor are they to be misled by mere pretenses. They are at liberty—indeed, are under a solemn duty—to look at the substance of things, whenever they enter upon the inquiry whether the Legislature has transcended the limits of its authority. If, therefore, a statute purporting to have been enacted to protect the public health, the public morals, or the public safety, has no real or substantial relation to those objects, or is a palpable invasion of rights secured by the fundamental law, it is the duty of the courts to so adjudge, and thereby give effect to the Constitution."

There can hardly be a fuller recognition of the necessity of establishing the reasonableness of a given exercise of the police power,

than is exhibited in this case, and of the authority of the courts, when properly invoked, to determine the same. So in *Barbier v. Connolly*, 113 U. S. 27, 5 Sup. Ct. 357, 28 L. Ed. 923, a municipal ordinance, prohibiting washing and ironing in public laundries and wash houses, from 10 o'clock at night to 6 in the morning, was decided to be within the scope of the police powers conferred upon the board of governors of San Francisco by the Legislature of the state, and that the fourteenth amendment did not interfere with the exercise of the same. Here again the court was at pains to consider the particular facts of the case presented, as bearing upon the reasonableness of this exercise of police power.

The power and duty of the court to determine the reasonableness of an exercise of the police power by a state, and the constitutional limitations which may be applicable thereto, is, on the other hand, affirmatively shown in the case of *Yick Wo v. Hopkins*, 118 U. S. 356, 6 Sup. Ct. 1064, 30 L. Ed. 220. In that case a municipal ordinance to regulate the carrying on of public laundries within the limits of the municipality was decided not to be a legitimate exercise of the police power of the state, because it conferred upon the municipal authorities arbitrary power to give or withhold consent as to persons or places for the carrying on of the business, and thus was inimical to the letter and spirit of the fourteenth amendment. In this case, clearly the constitutional provision, as to the deprivation of personal liberty or property, was applied by the court because, in its judgment, the regulation in question was not a reasonable, and therefore not a legitimate, exercise of the police power.

Anything like a general review of the cases in which the Supreme Court has dealt with the limitations upon the exercise of the police power of the states, by the provisions of the fourteenth amendment, or by the exclusive character of the power conferred upon Congress by the commerce clause itself, would unduly prolong this opinion. We will not refrain, however, from quoting the admirable statement made on this subject, contained in the opinion delivered for the court by Mr. Justice Day, in *Dobbins v. Los Angeles*, 195 U. S. 223, 25 Sup. Ct. 18, 49 L. Ed. 169. That was a case in which a municipal ordinance had fixed the limits within which gas works might be erected. A subsequent ordinance was adopted, amending the former one, by which latter the territory in which the works were in course of erection, was excluded. This ordinance was held to be void as an arbitrary and discriminatory exercise of the police power of the state, which amounted to an impairment of property rights protected by the fourteenth amendment. Recognizing the doctrine, that every intendment is to be made in favor of the lawfulness of the exercise of the police powers of a state, Mr. Justice Day proceeds as follows:

"But notwithstanding this general rule of law, it is now thoroughly well settled by decisions of this court, that municipal by-laws and ordinances, and even legislative enactments undertaking to regulate useful business enterprises, are subject to investigation in the courts with a view to determining whether the law or ordinance is a lawful exercise of the police power, or whether under the guise of enforcing police regulations there has been an unwarranted and arbitrary interference with the constitutional rights to

carry on a lawful business, to make contracts, or to use and enjoy property. In *Lawton v. Steele*, 152 U. S. 133, 137, 14 Sup. Ct. 499, 501, 33 L. Ed. 385, Mr. Justice Brown, speaking for the court, said upon this subject: "To justify the state in thus interposing its authority in behalf of the public, it must appear, first, that the interest of the public generally, as distinguished from those of a particular class, require such interference; and, second, that the means are reasonably necessary for the accomplishment of the purpose, and not unduly oppressive upon individuals. The Legislature may not, under the guise of protecting the public interests, arbitrarily interfere with private business or impose unusual and unnecessary restrictions upon lawful occupations. In other words, its determination as to what is a proper exercise of its police powers, is not final or conclusive, but is subject to the supervision of the courts." And again, in *Holden v. Hardy*, 169 U. S. 366, 398, 18 Sup. Ct. 383, 390, 42 L. Ed. 780, the same justice, again speaking for the court, said: "The question in each case is, whether the Legislature has adopted the statute in exercise of a reasonable discretion, or whether its action be a mere excuse for an unjust discrimination, or the oppression or spoliation of a particular class."

The learned justice then quotes with approval from the opinion of the Supreme Court of California, in the case of *In re Smith* (decided May 31, 1904) 143 Cal. 368, 77 Pac. 180, the following language:

"But, running current with this principle [that the courts will not interfere with state laws within the scope of their legislative power], and to be read with it, is one of equal importance, namely, that when the police power is exerted to regulate a useful business or occupation, the Legislature is not the exclusive judge as to what is a reasonable and just restraint upon the constitutional right of the citizen to pursue any trade, business or vocation, which in itself is recognized as innocent and useful to the community. It is always a judicial question if any particular regulation of such right is a valid exercise of police power, though the power of the courts to declare such regulation invalid will be exercised with the utmost caution, and only where it is clear that the ordinance or law declared void passes the limits of the police powers, and infringes upon rights guaranteed by the Constitution."

These cases, in regard to the police power of the states and the restraints imposed thereon by the fourteenth amendment, are exceedingly pertinent, as that power is at least as broad as the power of Congress to regulate commerce.

The cases cited by the government, from *Gibbons v. Ogden* down to the present time, which recognize the doctrine of that case, that the power granted by the commerce clause of the Constitution is exclusive of any like power remaining in the states, have manifestly no bearing upon the question we are now considering, viz., whether the power of Congress under the commerce clause is unlimited, as contended for by counsel for the government, or is subject to those "restrictions on the exercise of the power" which Chief Justice Marshall says "are found in the Constitution of the United States." No further reference need be made to them, except to point out that, by the recognition of the exclusiveness of this power, a further and distinct limitation is placed upon the exercise by the states of their police powers.

But it is further said, in the argument for the government, that the unlimited power of Congress over interstate commerce is illustrated in the embargo cases, and the question, whether Congress could prohibit all commercial intercourse between the states, and thus destroy what it was only empowered to regulate, is answered by saying that the question supposes an impossibility, and the authority of Chief Justice

Marshall is again invoked for the proposition which they formulate, as follows:

"That the policy of Congress, in the enactment of a law, is not within the judicial cognizance, that though all power granted to any department was liable to be abused, the remedy must be found at the ballot box."

We have already quoted Chief Justice Marshall's precise language in this respect, and have shown that he was speaking of the abuse of the power, as it existed under the grant of the Constitution, subject to those limitations inherent in its nature, or prescribed by the Constitution itself, and that if abused within its permitted bounds, such abuse could only be corrected by the people at the polls.

We need not enlarge upon the argument derived from the acquiescence in the embargo and nonintercourse acts. It is true, that both the power conferred to regulate commerce with foreign nations and with the Indian tribes, and the power to regulate the same among the states, are conferred in the same clause and by the same terms, and while the one is as complete as the other, each is complete with reference to the peculiar nature of its own subject-matter. The power to prohibit foreign commerce, in part or in whole, may in one aspect of it be part of the war power, and in another result from the inherent and necessary power recognized by international law in an independent nation, to control its intercourse with foreign nations to any extent, by treaty or otherwise, even to the extent of prohibiting all intercourse therewith. We hazard nothing in saying that the power to regulate commerce among the states could not be exercised to this extreme limit. The fundamental principles lying at the foundation of the Union of states, and the purposes for which such Union was formed, as well as the whole scheme of our constitutional government, insure the perpetuity of the freedom of commercial intercourse between the states, subject only to the legitimate control of Congress under the power to regulate the same. No case yet decided by the Supreme Court asserts the unlimited power of Congress, under the commerce clause, that is here contended for. On the contrary, the court has frequently asserted, in varying language, that the power to regulate commerce is subject to all the limitations imposed by the Constitution, and among them, that of the fifth amendment. The language of the court in *Monongahela Nav. Co. v. U. S.*, 148 U. S. 336, 13 Sup. Ct. 630 (37 L. Ed. 463) expresses the position assumed in all the cases touching this matter. It is as follows:

"Like the other powers granted to Congress by the Constitution, the power to regulate commerce is subject to all the limitations imposed by such instrument, and among them is that of the fifth amendment we have heretofore quoted."

All the argumentation of counsel for the government, in support of the validity of this legislation, would be equally applicable to any assertion of the power of Congress to regulate commerce, however arbitrary it might be, or to whatever extent, by prohibition or otherwise, it might affect the liberty or property of the citizen. If, as the Attorney General contends, the power of Congress to prohibit interstate commerce is as absolute as that exercised over foreign commerce in

the embargo and nonintercourse acts, Congress may, for any reason or no reason, prohibit, in whole or in part, the interstate transportation of necessary and harmless commodities and restrain the liberty of the citizens of the several states, or of certain classes of them, from engaging in interstate commerce therein. If the propositions laid down by the Attorney General are sound, it is hard to conceive upon what ground legislation could be challenged which arbitrarily prohibited farmers from carrying their own corn, by their own teams, to market across the boundary line between their own and another state. Such a power would be a mockery of the purposes for which the Constitution was formed, and destroy that freedom of interstate trade which it was intended to secure.

Counsel cite the so-called "Lottery Case," 188 U. S. 321; 23 Sup. Ct. 321, 47 L. Ed. 492, in support of their extreme contention, but even a cursory reading will show how far short of answering this purpose was the judgment in that case. The court decided that, though the power to regulate lotteries, and to permit or prohibit the sale of lottery tickets, was exclusively within the jurisdiction of the police power reserved to the states, yet lottery tickets, in view of their essential character as written certificates, were articles of value in the hands of the holder thereof, were the subjects of traffic, and therefore of commerce, and the regulation of the carriage of such tickets from state to state was a legitimate regulation of commerce among the states. The court, then, in addressing itself to the question, whether Congress, under the power of regulation, could prohibit the carriage of such articles entirely from state to state, in the exhaustive and erudite opinion written by Mr. Justice Harlan, said (the italics being ours):

"In determining whether regulation may not under *some* circumstances properly take the form or have the effect of prohibition, the nature of the interstate traffic which it was sought by the Act of May 2, 1895, to suppress cannot be overlooked. When enacting that statute Congress no doubt shared the views upon the subject of lotteries heretofore expressed by this court. In *Phalen v. Virginia*, 8 How. 163, 168, 12 L. Ed. 1030, after observing that the suppression of nuisances injurious to public health or morality is among the most important duties of government, this court said: 'Experience has shown that the common forms of gambling are comparatively innocuous when placed in contrast with the widespread pestilence of lotteries. The former are confined to a few persons and places, but the latter infests the whole community; it enters every dwelling; it reaches every class; it preys upon the hard earnings of the poor; it plunders the ignorant and simple.' In other cases we have adjudged that authority given by legislative enactment to carry on a lottery, although based upon a consideration in money, was not protected by the contract clause of the Constitution; *this, for the reason that no state may bargain away its power to protect the public morals*, nor excuse its failure to perform a public duty by saying that it had agreed, by legislative enactment, not to do so. *Stone v. Mississippi*, 101 U. S. 814, 25 L. Ed. 1079; *Douglas v. Kentucky*, 168 U. S. 488, 18 Sup. Ct. 199, 42 L. Ed. 553.

"If a state, when considering legislation for the suppression of lotteries within its own limits, may properly take into view the evils that inhere in the raising of money, in that mode, why may not Congress, invested with the power to regulate commerce among the several states, provide that such commerce shall not be polluted by the carrying of lottery tickets from one state to another? In this connection it must not be forgotten that the power of Congress to regulate commerce among the states is plenary, its complete in

itself, and is subject to no limitations except such as may be found in the Constitution. What provision in that instrument can be regarded as limiting the exercise of the power granted? What clause can be cited which, in any degree, countenances the suggestion that one may, of right, carry or cause to be carried from one state to another that which will harm the public morals? We cannot think of any clause of that instrument that could possibly be invoked by those who assert their right to send lottery tickets from state to state, except the one providing that no person shall be deprived of his liberty without due process of law. We have said that the liberty protected by the Constitution embraces the right to be free in the enjoyment of one's faculties; to be free to use them in all lawful ways; to live and work where he will; to earn his livelihood by any lawful calling; to pursue any livelihood or avocation, and for that purpose to enter into all contracts that may be proper.' *Allgeyer v. Louisiana*, 165 U. S. 578, 589, 17 Sup. Ct. 427, 41 L. Ed. 832. But surely it will not be said to be a part of any one's liberty, as recognized by the supreme law of the land, that he shall be allowed to introduce into commerce among the states an element that will be confessedly injurious to the public morals. * * *

"As a state may, for the purpose of guarding the morals of its own people, forbid all sales of lottery tickets within its limits, so Congress, for the purpose of guarding the people of the United States against the 'widespread pestilence of lotteries' and to protect the commerce which concerns all the states, may prohibit the carrying of lottery tickets from one state to another. In legislating upon the subject of the traffic in lottery tickets, as carried on through interstate commerce, Congress only supplemented the action of those states—perhaps all of them—which, for the protection of the public morals, prohibit the drawing of lotteries, as well as the sale or circulation of lottery tickets, within their respective limits. It said, in effect, that it would not permit the declared policy of the states, which sought to protect their people against the mischiefs of the lottery business, to be overthrown or disregarded by the agency of interstate commerce."

Here, as in the cases in relation to the exercise by the states of their police powers, in view of the "due process" provision of the fourteenth amendment, the Supreme Court has felt itself compelled to consider the reasonableness of this particular exercise of the power of Congress to regulate interstate commerce, in view of the nature of that power and of the "due process" clause of the fifth amendment. If this power of regulation is as absolute as contended for by the Government, and acknowledges none of the limitations prescribed by the Constitution, of which Chief Justice Marshall speaks in defining that power, the elaborate and convincing argument of the opinion in the Lottery Case, to show that interstate commerce should not be made available for the promotion of a pestilential form of gambling, destructive alike of the morals and material interests of the people, was wholly unnecessary. It would have been sufficient to say that the power was absolute and free from any limitation except the will of Congress, and that the reasonableness of its exercise was not a matter for judicial discussion or determination.

This harmful character of lotteries was judicially recognized as far back as 1833, by the Court of Errors and Appeals of Delaware (*Vanini v. Paine*, 1 Har. 65), in a case from which the following language is quoted and approved by the Supreme Court, in *Patterson v. Kentucky*, 97 U. S. 508, 24 L. Ed. 1115. The Delaware court said:

"At the time Yates and McIntyre made contracts for the lottery privileges set forth in the bill, we had in force an act of assembly prohibiting lotteries, the preamble of which declares that they are pernicious and destructive to

frugality and industry, and introductive of idleness and immorality, and against the common good and general welfare. It therefore cannot be admitted that the plaintiffs have a right to use an invention for drawing lotteries in this state, merely because they have a patent for it under the United States. A person might, with as much propriety, claim a right to commit murder with an instrument, because he held a patent for it as a new and useful invention."

That this was the particular ground upon which the decision in the Lottery Case, was based, is emphasized by the reference made in the opinion of the court to Act Cong. May 29, 1884, c. 60, 23 Stat. 31 (U. S. Comp. St. 1901, p. 299), prohibiting railroad companies or steam or sailing vessels from receiving, for interstate transportation, any live stock affected with contagious or infectious diseases, and especially the disease known as pleuro-pneumonia. This act was referred to in the case of Reid v. State of Colorado, 187 U. S. 137, 23 Sup. Ct. 92, 47 L. Ed. 108, in which it was decided that the act of that state, forbidding the introduction of cattle with infectious or contagious diseases, was constitutional, the court saying in its opinion:

"It is said that the defendant has a right under the Constitution of the United States to ship live stock from one state to another state. This will be conceded on all hands. But the defendant is not given, by that instrument, the right to introduce into a state, against its will, live stock affected by a contagious, infectious, or communicable disease."

It should not escape observation and comment, that the traffic in lottery tickets, as prohibited by Congress, was regarded as *malum in se*. It was pernicious and immoral in those who received those tickets in interstate transportation, as well as in those who issued and consigned them. The extirpation of such a traffic was, as said by Mr. Justice Harlan, a legitimate exercise, both of the police power of the state and of the like power of Congress in aid thereof under the commerce clause. Nothing like this is true of the case before us. The traffic sought to be here prohibited was admittedly, up to the time of the enactment in question, lawful, moral and innocent at both ends thereof. The one who bought the coal from the owner who delivered the same over his own road, was innocently enjoying a liberty of buying where he could buy to his own advantage, a liberty characteristic of healthy business activities everywhere. No reproach attaches or has ever attached to such conduct; indeed, the commodities clause itself refrains from denouncing it as a crime. It will be seen from the case just cited, that the reasonableness of a regulation of commerce, which amounts to a prohibition of any of the commodities which may form the subject-matter of interstate commerce, must be inquired into by the courts when the validity thereof is challenged, and it is also seen upon what grounds such validity can be sustained.

The practical wisdom of such an exercise of the judicial function is vindicated by its necessity. In no other way can the exercise of this vast and complete power conferred on Congress by the Constitution, be kept within the limitations imposed by that instrument itself, or its salutary efficiency be maintained.

The case of United States v. 43 Gallons of Whiskey, 93 U. S. 188, 23 L. Ed. 846, cited by the government, might have been placed upon

the same ground. But the court thought it necessary to place it upon the peculiar situation of the Indians, as quasi wards of the government, and upon the treaty-making power which was exercised by a stipulation in a treaty with an Indian tribe, that, within the territory thereby ceded, the laws of the United States, then or thereafter enacted, prohibiting the introduction of spirituous liquors in the Indian country, shall be in full force and effect.

We do not think the cases referred to under the anti-trust act (Act July 2, 1890, c. 647, 26 Stat. 209 [U. S. Comp. St. 1901, p. 3200]), such as *United States v. Joint Traffic Association*, 171 U. S. 571, 19 Sup. Ct. 25, 43 L. Ed. 259, and *Addystone Pipe Co. v. United States*, 175 U. S. 211, 20 Sup. Ct. 96, 44 L. Ed. 136, and *United States v. Trans-Missouri Freight Association*, 166 U. S. 290, 17 Sup. Ct. 540, 41 L. Ed. 1007, are at all applicable to the question here at issue. They deal with the illegality of contracts or combinations made in violation of the act of Congress, sometimes called the "Anti-Trust Law," and it is decided that that act refers to all contracts of every description, whether reasonable or unreasonable, and that courts have no right to discriminate in that regard, but, under the express language of the act, any contract in restraint of trade was within its purview. But it is well to refer for a moment to the grounds upon which the decisions in these cases are placed. In *United States v. Trans-Missouri Freight Association*, *supra*, after deciding that the statute was intended to apply to common carriers by railroad, the court, through Mr. Justice Peckham, says:

"The next question to be discussed is as to what is the true construction of the statute, assuming that it applies to common carriers by railroad? What is the meaning of the language as used in the statute, and that 'every contract, combination in the form of trust, or otherwise, or conspiracy in restraint of trade or commerce among the several states, or with foreign nations, is hereby declared to be illegal'? Is it confined to a contract or combination which is only in unreasonable restraint of trade or commerce, or does it include, what the language of the act plainly and in terms covers, all contracts of that nature?"

In reply to the contention that the statute should be so construed as to interdict only those contracts which were in unreasonable restraint of trade, the court replied, that its express language covered all contracts in restraint of trade, and that it was not permitted to the court to read into the statute a qualifying word, which made it apply to less than all such contracts. The plain intention of the law was to protect the freedom of trade, and it thus carried out what must be admitted to be the underlying purpose of the commerce clause of the Constitution. No question was raised as to the right of Congress to thus declare unlawful all contracts in restraint of trade. In a certain sense, the statute is declaratory of the common law, by which for centuries, such contracts have been denounced as illegal.

United States v. Joint Traffic Association, and *Addystone Pipe Co. v. United States*, *supra*, were decided upon the authority of the case just quoted from. They concern the enforcement of the same provisions of the anti-trust law, and declare that private agreements between persons or corporations, tending directly, and not indirectly or incidental-

ly, to restrain trade among the states, were unlawful. It is no longer contended that the interdiction of such contracts is not a valid exercise of the power to regulate interstate commerce. The decisions in these cases, and others of the same class, plainly have no bearing upon the questions we have here to consider.

It is unnecessary to discuss in detail the numerous decisions of the Supreme Court, which recognize, directly or impliedly, the duty of the court to inquire into and determine the reasonableness of legislation, purporting to be a regulation of commerce under the commerce clause of the Constitution, as to its being properly such, or as to whether it contravenes the inhibition of the fifth amendment, by depriving any person of life, liberty or property without due process of law. Among the cases relied upon by the Attorney General, in support of the "commodities clause," is the case of *New Haven Railroad Co. v. Interstate Commerce Commission*, 200 U. S. 361, 26 Sup. Ct. 272, 50 L. Ed. 515. A brief review of the facts in that case, and its ratio decidendi, we think will show that, far from supporting the contention made by the learned Attorney General, it distinctly fails to do so. The charge was that the Chesapeake & Ohio Railroad was engaged in the carriage of coal, as interstate traffic, between a district of West Virginia and Newport News, Va., for delivery thence to the New Haven, in Connecticut, and that the traffic was being moved at less than the published rates, and in such a way as to produce a discrimination in favor of the New Haven road, as against others, in violation of the act to regulate commerce, and the amendments thereto. The Chesapeake & Ohio had made a verbal agreement with the New Haven to sell to that road 60,000 tons of coal, to be carried from the Kanawha district to Newport News, and thence by water to Connecticut, for delivery to the buyer at \$2.75 per ton, and that a considerable portion had already been delivered, and the remainder was in process of delivery. It was charged that, in order to comply with this contract, the Chesapeake & Ohio bought the coal at the mines, and that the price paid and the cost of transportation from Newport News to Connecticut would aggregate \$2.47 per ton, thus leaving to the Chesapeake & Ohio only about 28 cents a ton for carrying the coal to Newport News, whereas, the published tariff for like carriage from the same district was \$1.45 per ton. The petition alleged that the Chesapeake & Ohio asserted that, although the total price which it received for the coal covered by the verbal agreement, was less than the total outlay in delivering the coal, including its published rates, such fact did not amount to a departure from the published rates, and was not a discrimination, for two reasons: First, because, if such difference existed, it was a loss suffered by the Chesapeake & Ohio, not from taking less than its published rate, but because it had received less as a purchaser than the coal had cost; second, that, even if it had not the lawful right thus to impute the payment of the price of the coal, the Chesapeake & Ohio had, in fact, received much more for the coal than the price in money agreed on, because, at the time of the verbal agreement to sell, the New Haven had a claim of \$100,000 against the Chesapeake & Ohio, which was to be extinguished by the completion

of the delivery of the coal, and in this way caused the price thereof largely to exceed the cost of the coal to the Chesapeake & Ohio, including its published rates. With his usual perspicuity, Mr. Justice White brushed aside the sophistry of the contention, that by purchasing the coal at the mines the Chesapeake & Ohio could avoid the requirement of the act, that it should not carry coal for less than its published rates; and held that, where the difference between the price paid for the coal at the mines and that for which it was sold was not sufficient to cover the published freight rates for carrying the same, the charging of the full rates for the freight, and entering up in their books the difference between those rates and the prices at which the coal was to be delivered in New Haven, as the price actually received, was a mere device in fraud of the law, and was a palpable violation thereof. Accordingly, it was decreed that the contracts made by the Chesapeake & Ohio with the New Haven were contrary to public policy, and void, because in conflict with the prohibitions of the act to regulate commerce, and the Chesapeake & Ohio was perpetually enjoined from taking less than the rates fixed in its published tariff, by means of dealing in the purchase and sale of coal.

The question, as put by the learned justice, is this:

"Has a carrier engaged in interstate commerce the power to contract to sell, and transport in completion of the contract, the commodity sold, when the price stipulated in the contract does not pay the cost of purchase, the cost of delivery, and the published freight rates?"

Further on, it is said:

"Now in view of the positive command of the second section of the act, that no departure from the published rate shall be made 'directly or indirectly,' how can it in reason be held that a carrier may take itself from out the statute in every case, by simply electing to be a dealer, and transport a commodity in that character?"

The opinion is a most interesting one, and completely demonstrates the futility of any attempt to avoid the inhibitions of the act against discriminations in freight rates by one who deals in or owns the coal to be transported, if such attempt, like any other violation of the law, is prosecuted in the courts having jurisdiction of the same. It is true that, in the opinion, the duality of ownership and transportation of commodities is animadverted upon as presenting a temptation to avoid thereby the requirements of the act. But conditions or situations may not be destroyed by the mere fiat of an act of Congress, because they may create temptations for violating the law. It was one thing to say, as was said by Mr. Justice White in this case, that it did not matter, so far as it affected the power to enforce the requirements of the interstate commerce act in the case before the court, that its enforcement might make it difficult or impossible for a railroad company to transport its own coal in interstate commerce, but quite a different thing for Congress to say, in the first instance, that such coal could not be so carried at all. In one case, the regrettable inconvenience to the public, and injury to a private property right merely incidental to the enforcement of a valid regulation of commerce, were not allowed to obstruct the same, while, on the other hand—the case we are

now considering—these regrettable results are sought to be brought about directly by legislative enactment, independently of any other asserted regulation of commerce. It is perfectly clear that in the application of this well-settled doctrine as to the incidental loss or injury that may result from the enforcement of valid laws, Mr. Justice White is not to be taken as, even by way of obiter dictum, sanctioning the validity of the act here in question. When he speaks of “proper rules and regulations for the segregation of the business of producing, selling and transporting, as presented in the Haddock and Coxe Cases (before the Interstate Commerce Commission), as not being confiscatory,” the meaning is evident that, in the business of carrying its own coal by a railroad carrier, there should be a “segregation” of the same into such departments as would make plain in any case, whether a fraud upon the law against discrimination was being practiced. The course so pointed out would have fully regulated commerce in anthracite coal, without at all restraining it or depriving the carriers in question of the full enjoyment of their corporate powers, and of the properties lawfully and innocently acquired thereunder. With this remedy for the supposed evil in the hands of Congress, the unreasonableness of the statute under consideration as a regulation of commerce, becomes still more apparent. It extirpates and destroys an entirely lawful business, in order to stamp out the evils which may be practiced in its conduct.

Applying the philosophy of this case to those before us, it is obvious that, instead of a competent and efficient regulation of commerce, directly dealing with the evil of the situation, by explicitly forbidding and penalizing all such discriminations in freight rates as were possible of commission under guise of the ownership of the commodity carried, the enactment in question has excluded from interstate commerce all commodities owned by the carrier, whether their transportation be carried on in conformity with the legal requirements against discrimination, or not. Such an exclusion can only be justified by the assumption that a carrier, who transports his own coal, as well as that of others, must discriminate. It could hardly be more unreasonable to forbid the burning of coal on the locomotives, and compel a resort to wood for fuel, because the carriage and distribution of such coal might furnish the opportunity for the attempt to discriminate in freight rates, as to the coal necessarily remaining after the preparation of coal for their own steam purposes.

It has long been settled that, because the products of domestic enterprises in agriculture, manufactures, or the arts, may ultimately become the subjects of interstate or foreign commerce, the control of the means or the encouragements by which they are fostered and protected, are not on that account within the regulative power of Congress. *Veazie v. Moor*, 14 How. 573, 14 L. Ed. 545; *Kidd v. Pearson*, 128 U. S. 1, 9 Sup. Ct. 6, 32 L. Ed. 346. A fortiori, that power cannot be extended, in the guise of regulation, to the destruction of property interests which only indirectly affect interstate commerce, and this, we think, is true independently of any consideration of the effect of such a regulation as an arbitrary spoliation of property rights, within the protection of the fifth amendment.

Counsel for the government have dwelt much upon the case of *Union Bridge Co. v. United States*, 204 U. S. 364, 27 Sup. Ct. 367, 51 L. Ed. 523, to show the unlimited character of the power to regulate commerce. The complete control of Congress under this power, over the navigable waters of the United States, as highways of interstate or foreign commerce, for the purpose of keeping them clear and unobstructed for navigation, has long been recognized. Any physical obstruction to or interference with their free navigation, may undoubtedly be dealt with as such by Congress. These waters are public highways of the nation, and no one can be so permitted to encroach upon them, as to deprive Congress of the right and power to abate the public nuisance thereby created. No one can acquire rights as to such navigable waters, in derogation of the public right to navigate the same. This was the doctrine of the *Union Bridge Co. Case*. Its bridge, though permitted to be built at a time when it did not interfere with the navigation of the Allegheny river, afterwards, owing to the development of commerce, became an obstruction to such navigation, and as such, was properly required to be so altered in height as to prevent its being an obstruction. The pecuniary loss resulting thereby to the owners, was not in any proper sense a taking of private property for public use, without compensation, or a deprivation thereof without due process of law under the fifth amendment.

Arguments from analogy are always to be guardedly used, as they are often misleading. The argument is seriously made that, as Congress may remove a physical obstruction to navigation, like a rock or a bridge, it may call anything it chooses an obstruction, not to navigation, but, to commerce generally, and require its removal. It hardly needs to be pointed out that the analogy is unsound and fanciful. It would have us conclude that, because Congress can declare a rock or a bridge an obstruction to navigation, and require its removal, it may also declare the otherwise lawful carriage of their owner's harmless commodities by the boats navigating the river, to be an obstruction to commerce, and so forbid it. If, indeed, the latter may be done, there is no logical nexus between the two. The bridge may be removed as a patent physical obstruction to navigation, and so, pro tanto, an obstruction to commerce, but it could hardly be contended that Congress could, by declaring a house situated a mile back from a river an "obstruction" to its navigation, escape the inhibitions of the fifth amendment. Such an assertion of power would clearly come within the scope of the judgment in the case of *Monongahela Navigation Co. v. U. S.*, supra. A fortiori, Congress cannot, by merely calling a theretofore lawful and harmless social or business situation an obstruction to interstate commerce, escape the inhibitions of the said amendment, in decreeing its destruction.

It is clearly a judicial question, not to be avoided, whether this enactment, known as the "commodities clause," in view of the character of the discriminations made by it, as between owners of property, and of the inhibitions of the fifth amendment to the Constitution, is a reasonable exercise of the power conferred upon Congress to regulate interstate commerce. Passing its discriminatory features, we con-

fine ourselves to the consideration, whether the enactment in question is violative of any right of the defendants, within the protection of the fifth amendment. The facts appearing in these several cases, in regard to the history of the character and extent of the ownership and interests in coal and coal lands of these defendants, that will be injuriously affected by the enforcement of this law, render it impossible to say that there has not been a deprivation, as to each of them, of its liberty and its property, within the meaning of that clause of the fifth amendment which forbids that any person shall be deprived of life, liberty or property without due process of law.

It is to be observed in the first place, that the act is in a certain sense retroactive. It applies to or affects property lawfully acquired long prior to the date of its enactment, and lawfully and innocently enjoyed under the sanction of the laws of Pennsylvania during long periods of years prior thereto, and is not confined to the dual ownership of transportation and property acquired after the passage of the act. In forbidding the defendants to transport in interstate commerce the products of the mines owned by them, or in which they are directly or indirectly interested, it cannot be doubted, from the facts stated in the records before us, that a most important, if not the most important, property right attaching thereto is stripped from these defendants. As we have before said, it is to no purpose to assert that they are not, by force of this enactment, deprived of the legal title to these various properties. Courts "are at liberty—indeed are under a solemn duty—to look at the substance of things, whenever they enter upon the inquiry whether the Legislature has transcended the limits of its authority." It is perfectly clear, from the conditions, as stated, under which these coal lands, mines, and interests in coal companies are held by these defendants, that the deprivation of the right to carry their products in interstate commerce is a deprivation of the most valuable property right attaching thereto. It is urged by the government, however, that the defendants may divest themselves of these properties, by selling the same. Such a suggestion seems only to emphasize the arbitrary and despotic character of the legislative act. The thing commanded bears no relation to that which is within the power of Congress to prescribe.

The regulation must be within the restrictions of the Constitution, reasonably construed in application thereto. In determining this question of reasonableness, the carefully considered expert opinion of the Interstate Commerce Commission is entitled to great weight. In distinguishing the case of *Grain Rates of Chicago Great Western Ry. Co.*, 7 *Interst. Com. R.* 33, from those of *Haddock v. D., L. & W. R. Co.*, 3 *Interst. Com. R.* 302, and *Coxe Bros. & Co. v. Lehigh Valley R. R. Co.*, *Id.* 460, the learned Commission said:

"Those cases are in no respect similar to this. In both, the common carrier was also the owner of extensive coal fields, and indeed it had become a common carrier largely for the purpose of transporting the product of those mines to market. This state of things existed before the passage of the act, and had no reference to the act. Unless the carrier was permitted to transport its coal, the result would be in effect the confiscation of its property, and to order it to charge itself with a particular rate would merely re-

sult in a matter of book-keeping. Under these circumstances, it was held that the only remedy was to inquire whether the rate charged the complainant was a reasonable one."

Even if wrong in their conclusion, as intimated by Mr. Justice White, that an enforcement of the prohibition against discrimination in rates, under proper rules and regulations for the separation of the business of producing, selling and transporting into appropriate departments, would have amounted to an interdiction on the carrier as to carrying his own coal, and have been, therefore, confiscatory in its results, this does not detract from the force of the judgment expressed by the Commission, that if the operation of the act were such as to interdict the interstate carrying of coal by the railroad carriers owning or interested in the same, it would be practically a confiscation of its property. Yet, this is just what the "commodities clause," not indirectly, but directly, does. As said by one of the counsel who argued these cases at the bar:

"To prevent favoritism and discrimination, it is not necessary to deprive the carrier of its right to transport its own commodities, to render useless hundreds of millions of dollars of its improvements, or practically to destroy the value of property by forbidding its transportation."

The provision, that no person shall be deprived of liberty or property without due process of law, would, indeed, be shorn of its vitality if the contention of the government in the premises can be sustained. If, without regard to the exigence of the fifth amendment, we merely compare the consequences of this so-called regulation of commerce to the property and property rights of these defendants, with what we are told is the end to be achieved by this so-called regulation of interstate commerce, the utter unreasonableness of the said regulation will still more clearly appear. A property right, of almost incalculable value, which these defendants have hitherto innocently enjoyed in common with the citizens of Pennsylvania and of all the other states, is stricken down for the alleged purpose of preventing discrimination by common carriers, as owners and carriers of such property, as against others who may lawfully require their services. It hardly needs pointing out, how enormous the disparity between the value and importance of the end accomplished and the cost of the means employed for the accomplishment; and this, too, when any such discrimination, if it exists, can be remedied by regulations bearing a direct relation thereto. But, to further make the disparity between the means and the end to be accomplished more apparent, it is not because such discriminations are practiced, but because they possibly may be practiced.

From every point of view from which we have been able to approach the question, the unreasonableness and consequent invalidity of this so-called "commodities clause" is apparent. It invades the rights of the state, by striking down the liberty hitherto innocently enjoyed by its citizens under the laws and usages of the commonwealth, to engage in interstate commerce to the fullest extent, as to all harmless articles, whether owned or not owned by the carrier, and deprives of their property these defendants, contrary to the letter and spirit of

the fifth amendment to the Constitution. If the enactment in question be warranted by the commerce clause of the Constitution, it is hard to see what bounds may be set to the exercise of that power. It will indeed be an open door, through which the forces of a centralization hitherto unknown may enter at will, to the overthrow of that just balance between federal and state power, for which the makers of the Constitution so wisely provided, as an essential to the preservation of our dual form of government.

We confine ourselves to the concrete facts presented by the pleadings in these cases, and express no opinion as to cases where property has been acquired by the carriers subsequent to the passage of the act. For the reasons stated, therefore, these bills in equity are dismissed, and the petitions for writs of mandamus on the law side of this court are denied.

DALLAS, Circuit Judge (concurring). I fully concur in the foregoing opinion, and the little now to be added is intended merely to accentuate my acceptance of it.

It was held in the Lottery Case, 188 U. S. 321, 23 Sup. Ct. 321, 47 L. Ed. 492, that the power of Congress to regulate commerce among the states is plenary, and is subject only to such limitations as the Constitution imposes upon its exercise; but it was not held that the power committed to Congress to prescribe the rules by which interstate commerce is to be governed authorizes the interdiction of its pursuit by any person or persons, natural or artificial, without regard to the character of the traffic sought to be proscribed. It was decided, it is true, that the prohibition of the carriage of lottery tickets is an "appropriate mode for the regulation of that particular kind of commerce"; but it was not decided that prohibition, apart and distinct from regulation, may be ordained, or that as a mode for regulation it would universally, or even generally, be appropriate. On the contrary, it was said that:

"In determining whether regulation may not under some circumstances properly take the form or have the effect of prohibition, the nature of the interstate traffic * * * cannot be overlooked."

Where it is "a kind of traffic which no one can be entitled to pursue as of right," its pursuit by any one may be prevented. This the Lottery Case has established; but that a common carrier may be forbidden to transport from one state to another any article or commodity, however useful and inoffensive, which Congress may choose, no matter with what motive, to exclude from such transportation, neither the Lottery Case nor any other has determined.

The prohibitory intent of the piece of legislation under consideration is too plain for disavowal, and the suggestion that what it prohibits is not interstate commerce, but interstate transportation by a railroad company of commodities which it has produced, etc., is delusive. The question is not whether the carriage from state to state of coal produced by the carrier is interstate commerce, for of course it is, but whether, being a kind of commerce which is not inimical to safety, health, or morals, and which, therefore, any one is entitled to pur-

sue "as of right," Congress may restrict a railroad company's interstate transportation of coal to coal not mined or owned by it and in which it has no interest. Any such restriction, whatever it may be called, in its nature and effect is discriminative prohibition; and that the restrictive provision now in question was enacted, not actually for the regulation of interstate commerce, but really to coerce the conformity of intrastate business with a "policy" approved by Congress, seems practically to be admitted, and could not, with candor, be denied.

"While every possible presumption is to be indulged in favor of the validity of a statute, the courts must obey the Constitution rather than the lawmaking department of government," and they have been charged with no duty more exalted or imperative than that of resolutely resisting the assumption by that department of any power not delegated to it by the Constitution, let the pretext or ostensible object be what it may. No court has authority, under the guise of interpretation, to change the Constitution for the purpose of meeting a supposed requirement of present conditions, and the covert tendency of any usurpation of such authority would inevitably be to transform the government of enumerated powers which the Constitution established into a government with all power vested in its legislative and executive branches.

But there are rights not derived from the Constitution, though they may be secured by it, which in any free government must be conceded to be beyond invasion by any of its departments (*Loan Association v. Topeka*, 87 U. S. 662, 22 L. Ed. 455), and the inherent right of the states to unrestricted innoxious commercial intercourse never has been relinquished nor made dependent upon the sufferance of the body to which its regulation was confided, not for its suppression in whole or in part, but to foster its benefits and preclude its obstruction. The right itself was "retained by the people," and by no subterfuge can any of the people, whether incorporate or not, be deprived of it. Moreover, the states, subject only to the powers delegated to the United States by the Constitution or prohibited by it to the states, have severally the right, within their respective geographical limits, to the administration of their own law for the maintenance and defense of life, liberty, and property; and consequently Congress, unless in aid of the unfeigned exercise of a power possessed by it, has no authority whatever to divest, limit, or impair any property right which competent state law recognizes and protects. Yet we are confronted in these cases with an attempt to subvert by congressional edict the right to use and enjoy property of the utmost value, which was acquired and has long been held under state law of unquestionable validity, and to withhold from the people of many of the states a commodity which has aptly been characterized as "a prime necessity of life and an essential of civilization." Such legislation is incompatible with free government (*Loan Ass'n v. Topeka*, supra), and, in my opinion, it is simply impossible to find support for it in a grant of power to regulate commerce, coupled with a mandate that private property shall not be taken for public use without just compensation, and that

no person shall be deprived of liberty or property without due process of law. The inclination sometimes manifested to centralize power in the general government results in great measure, no doubt, from the apparent expediency of committing to it the correction of ills which it is supposed that the states cannot so readily repress; but the achievement of no presently desired end, however salutary, can justify the infraction of our fundamental law, or warrant its perversion by insidious construction. The Constitution of the United States is a written instrument, not a progressive development, and the often quoted epigram that "constitutions are not made but grow," should not apply to it.

BUFFINGTON, Circuit Judge (dissenting). These cases involve the constitutionality of the fifth paragraph of the first section of an act of Congress, approved June 29, 1906, which provides:

"From and after May 1, 1908, it shall be unlawful for any railroad company to transport from any state, territory, or the District of Columbia, to any other state, territory, or the District of Columbia, or to any foreign country, any article or commodity, other than timber and the manufactured products thereof, manufactured, mined, or produced by it, or under its authority, or which it may own in whole, or in part, or in which it may have any interest, direct or indirect, except such articles or commodities as may be necessary and intended for its use in the conduct of its business as a common carrier."

In *Brown v. Walker* (C. C.) 70 Fed. 46, where the constitutionality of the immunity clause of the interstate commerce act, already held unconstitutional in another jurisdiction (*United States v. James* [C. C.] 60 Fed. 257, 26 L. R. A. 418), came before Judge Acheson and myself, the court said:

"When a statute has been passed by the legislative branch of the government, the judicial branch will act with great caution in declaring it unconstitutional, and will do so 'only,' as Chief Justice Black said in *Sharpless v. Mayor, etc., of Philadelphia*, 21 Pa. 164, 59 Am. Dec. 759, 'when it violates the Constitution clearly, palpably, plainly, and in such manner as to leave no doubt or hesitation on our minds.' For, as Chief Justice Marshall said in *Fletcher v. Peck*, 6 Cranch, 126, 3 L. Ed. 162: 'The question whether a law be void for its repugnancy to the Constitution is, at all times, a question of much delicacy, which ought seldom, if ever, to be decided in the affirmative in a doubtful case. The court, when impelled by duty to render such a judgment, would be unworthy of its station, could it be unmindful of the solemn obligations which that station imposes. But it is not on slight implication and vague conjecture that the Legislature is to be pronounced to have transcended its powers, and its acts to be considered as void. The opposition between the Constitution and the law should be such that the judge feels a clear and strong conviction of their incompatibility with each other.'"

This extract states my attitude toward the act now before this court. That act is an alleged exercise of power under the eighth section of article 1 of the federal Constitution, which conferred on Congress power "to regulate commerce * * * among the several states." Its subject-matter is "any article or commodity, other than timber and the manufactured products thereof, manufactured, mined, or produced" by an interstate railroad, or "which it may own in whole or in part, or in which it may have any interest, direct or indirect." That it affects such articles only when they have reached a commercial stage, viz., are "manufactured, mined, or produced," and become subjects of inter-

state commerce, viz., by carriage "from any state, territory, or the District of Columbia, to any other state, territory, or the District of Columbia, or to any foreign country," the act provides. And that such commodities are articles of commerce is clear. *Gibbons v. Ogden*, 9 Wheat. 1, 6 L. Ed. 23. These commodities, the act says, it shall be unlawful for any railroad to transport between the states when "manufactured, mined, or produced by it, or under its authority, or which it may own in whole, or in part, or in which it may have any interest, direct or indirect." It does not forbid a railroad to own or operate mines or manufactories. It does not preclude sale of its product or debar carriage thereof from the state. It simply puts the carrier owner on the basis of all other owners and shippers of commodities, viz., transportation of its and their product by a disinterested carrier. Its manifest purpose is to prevent, in shipments, favor to any, and secure fairness to all.

At this point we note that the prior action of any state authorizing such carrier to own manufactories or mines could in no way detract from the power of Congress to thereafter regulate interstate commerce. Manifestly, such purchases under state authority created no obligation or contract on the part of Congress that it never would, in pursuance of its power to regulate commerce between the states, enact laws which might restrict carriers from the interstate carriage of their own products. Mere inaction, mere omission to exercise a constitutional power, cannot estop that body; for such a doctrine of congressional estoppel would compel it to forestall the laws of every state and seriously impair the exercise of the power to regulate commerce. In effect it would place in each state a veto on the power to regulate conferred on the United States. The contention for congressional estoppel is best answered by Mr. Justice Harlan in *Union Bridge Company v. United States*, 204 U. S. 400, 27 Sup. Ct. 380, 51 L. Ed. 523, where he says:

"There are no circumstances connected with the original construction of the bridge, or with its maintenance since, which so tie the hands of the government that it cannot exert its full power to protect the freedom of navigation against obstructions. Although the bridge, when erected under the authority of a Pennsylvania charter, may have been a lawful structure, and although it may not have been an unreasonable obstruction to commerce and navigation as then carried on, it must be taken, under the cases cited, and upon principle, not only that the company when exerting the power conferred upon it by the state, did so with knowledge of the paramount authority of Congress to regulate commerce among the states, but that it erected the bridge subject to the possibility that Congress might, at some future time, when the public interest demanded, exert its power by appropriate legislation to protect navigation against unreasonable obstructions. Even if the bridge, in its original form, was an unreasonable obstruction to navigation, the mere failure of the United States, at the time, to intervene by its officers or by legislation and prevent its erection, could not create an obligation on the part of the government to make compensation to the company if at a subsequent time, and for public reasons, Congress should forbid the maintenance of bridges that had become unreasonable obstructions to navigation. It is for Congress to determine when it will exert its power to regulate interstate commerce. Its mere silence or inaction when individuals or corporations, under the authority of a state, place unreasonable obstructions in the waterways of the United States, cannot have the effect to cast upon the government an obligation not to exert its Constitutional power to regulate inter-

state commerce, except subject to the condition that compensation be made or secured to the individuals or corporation who may be incidentally affected by the exercise of such power. The principle for which the bridge company contends would seriously impair the exercise of the beneficent power of the government to secure the free and unobstructed navigation of the waterways of the United States. We cannot give our assent to that principle."

But in the present cases we have a different situation. The purpose of this federal statute of 1906, to divorce, in interstate commerce, the dual relation of carrier and producer, was anticipated by intrastate legislation 30-odd years before by the state of Pennsylvania. In its Constitution of 1874 (section 5, art. 17) that state provided that:

"No incorporated company, doing the business of a common carrier shall, directly or indirectly, prosecute or engage in mining or manufacturing articles for transportation over its works, nor shall such company, directly or indirectly, engage in any other business than that of a common carrier, or hold or acquire lands, freehold or leasehold, directly or indirectly, except such as shall be necessary for carrying on its business; but any mining or manufacturing company may carry the product of its mines and manufactories on its railroad or canal not exceeding fifty miles in length."

The effect of this constitutional provision upon the legality of the purchase of lands by carriers has never been passed upon by the Supreme Court of that state. Assuming it was not self-operative, in the sense that it required legislation to enable the state to forfeit title to lands acquired in the face of it, for this alone was decided in *Commonwealth v. New York, Lake Erie & Western Railroad Company*, 132 Pa. 591, 19 Atl. 291, 7 L. R. A. 634, yet certain it is it strips every purchase in Pennsylvania since 1874 of mining properties by common carriers of the status of innocent purchases, and the answers do not allege that the purchases of these respondents were all prior thereto and whether or not they had elected to accept the provisions of the Constitution. Now the object of this federal statute is clear. It seeks, in the sphere of interstate commerce, and, be it observed, in it alone, to enforce proper service by carriers of such commerce, by divorcing their public duty as common carriers from their private interest in carrying their own products. It forbids them to become competitors of their own customers. Such carriers are created and vested with public rights to enable them to serve as common carriers. "The question," say the Supreme Court in *Cherokee Nation v. South Kansas Railroad Company*, 135 U. S. 657, 10 Sup. Ct. 971, 34 L. Ed. 295, "is no longer an open one as to whether a railroad is a public highway, established primarily for the convenience of the people and to subserve public ends." So far as this dominant, public purpose is concerned, their lawful ownership of private property is an incident to enable them to fulfill, certainly not to thwart, this public duty. "Though the corporation in respect to its capital is private, yet it was created to accomplish objects in which the public have a direct interest and its authority to hold land was conferred that these objects might be worked out." *Western Union Telegraph Company v. Pennsylvania Railroad Company* (C. C.) 120 Fed. 367, quoting *Railroad v. Colwell*, 39 Pa. 339, 80 Am. Dec. 526.

Now, rightly or wrongly, Congress determined that the interstate carriage of the commodities produced from carriers' property injuri-

ously affected their public duty, and enacted that the full enjoyment of the secondary and private right of private carriage must yield to the primary and higher requirement of public duty. Of the wisdom of that body in adopting the particular course of the statute the courts cannot inquire. "The question is for us one of power only, and not of policy." *United States v. Joint Traffic Association*, 171 U. S. 505, 19 Sup. Ct. 25, 43 L. Ed. 259. For, as said of the interstate commerce act by Mr. Justice White in *New Haven Railroad Company v. Interstate Commerce Commission*, 200 U. S. 399, 26 Sup. Ct. 280, 50 L. Ed. 515:

"If the result of applying the prohibitions as we have interpreted them will be practically to render it difficult, if not impossible, for a carrier to deal in commodities, this affords no ground for relieving us of the plain duty of enforcing the provisions of the statute as they exist. This conclusion follows, since the power of Congress to subject every carrier engaging in interstate commerce to the regulations which it has adopted is undoubted."

That the regulation of interstate commerce was the object of this law is clear. When it was under consideration the mover of the amendment said it was intended—

"to divorce transportation from production on the part of the railroads engaged in transporting coal they mined and sold in competition with other shippers, which was a great abuse. This abuse grew into a grievous wrong to independent shippers. I sought to correct this abuse by an amendment confining railroads to their legitimate business of transporting freight and passengers, and prohibiting them from engaging in the transportation of any commodity which they might own, except for their own use."

Indeed, the dual and conflicting relation of public carrier and private producer was a matter of common observation. We have seen how it had been constitutionally forbidden in Pennsylvania in 1874. In the case of *Attorney General of Great Britain v. Great Northern Railway Company*, 29 Law Journal (N. S. Equity) 794, decided in 1860, the question was whether dealing in coal by a railroad was illegal, because incompatible with its duty as a public carrier and calculated to injure the public. It was there held that the act of Parliament granting the charter to operate the railroad implied a prohibition against the company engaging in any other business; the court saying:

"These large companies, joint-stock companies generally, for whatever purpose established, and more particularly railway companies, are armed with powers of raising and possessing large sums of money—large amounts of property—and if they were to apply that money, or that property, to purposes other than those for which they were constituted, they might very much injure the interests of the public in various ways. * * * Here we find this company, having the traffic from the north of England, where the great coal fields are (at least some of the principal coal fields), supplying the country with coal, or capable of supplying it. This company buys the coal, which gives to the company an interest in checking, as much as possible, those who will not deal with them; and it is quite clear that it is possible, by the mode in which this company may—I will not say has, but by the mode in which this company may—exercise such powers as either it has or assumes to have, this company may get into their hands the traffic; that is, the dealing in all the coal in the large districts supplying coal to the country. They have to a considerable extent done so, and there is no reason why it should not go on progressing. I observe that in the six years from 1852 to

1857, inclusive, the amount of their coal business has increased from 73,000 tons to 794,000 tons; and there is no reason, as the affidavits show, why they should not—there is great danger that they may—get into their hands the entire business in the coal of all that district of country. * * * There is, therefore, great detriment to the interests of the public, for this reason, taking merely the article of coal.”

Accordingly an injunction was granted, and, no case to the contrary being cited, it would seem that its principles now are, and since 1860 have been, the law of England on the dual relation of common carriers.

Moreover, this dual relation of public carrier and private producer was involved in the case of *New Haven Railroad Company v. United States*, supra, and in discussing its effect on the requirement of the interstate commerce act that the carrier adhere to published rates Mr. Justice White said:

“The existence of such a power in its essence would enable a carrier, if it choose to do so, to select the favored persons from whom he would buy and the favored persons to whom he would sell, thus giving such persons an advantage over every other, and leading to a monopolization in the hands of such persons of all the products as to which the carrier chose to deal. Indeed, the inevitable result of the possession of such a right by a carrier would be to enable it, if it chose to exercise the power, to concentrate in its own hands the products which were held for shipment along its line, and to make it, therefore, the sole purchaser thereof and the sole seller at the place where the products were to be marketed: in other words, to create an absolute monopoly. To illustrate: If a carrier may, by becoming a dealer, buy property for transportation to a market and eliminate the cost of transportation to such market, a faculty possessed by no other owner of the commodity, it must result that the carrier would be in a position where no other person could ship the commodity on equal terms with the carrier in its capacity of dealer. No other person owning the commodity being thus able to ship on equal terms, it would result that the owners of such commodity would not be able to ship, but would be compelled to sell to the carrier.”

In the light of these views, it must be presumed, for every presumption of the integrity of purpose of the lawmaking power must be made, that Congress, in passing this act, sought not to confiscate private property, but rather to avert by due regulation the evils the carrier had itself brought about by allowing private interest to injuriously affect public duty. And while, as we have said, the wisdom or otherwise of Congress in the measures it adopts is not a subject of judicial scrutiny, for “in determining the character of the regulations to be adopted Congress has a large discretion which is not to be controlled by the courts, simply because, in their opinion, such regulations may not be the best or most effective that could be employed” (*Lottery Case*, 188 U. S. 353, 23 Sup. Ct. 321, 47 L. Ed. 492), yet the recognition by courts of an evil to be remedied and the avowed purpose of Congress to stop such evil may throw some light on that which, after all said, is a question of fact, rather than law, namely, whether this act is a real regulation of commerce, or, under the guise of regulation, a prohibition of holding property. And as bearing on the conditions in view of Congress the facts set forth in the answer of one of the defendants are highly suggestive, viz.:

“This defendant, further answering, says that anthracite coal is an article of prime necessity and is universally used for domestic purposes throughout New England and the Middle Atlantic states, and to a great extent through-

out other sections of the country. The source of the entire supply, save a few small deposits of inferior quality, is located within the state of Pennsylvania, and the deposits extend over an area of only about 484 square miles, divided for trade purposes into three 'regions,' the Wyoming (sometimes called the Lackawanna) region, the Lehigh region, and the Schuylkill region. Ninety per cent., approximately, of the entire unmined area of anthracite coal is owned or controlled by the following named companies, or by 'subsidiary coal companies,' so called—that is, companies in which they have an entire or controlling stock interest—viz., the Reading Company, the Pennsylvania Railroad Company, the Delaware, Lackawanna & Western Railroad Company, the Lehigh Valley Railroad Company, the Central Railroad of New Jersey, the Delaware & Hudson Company, the Erie Railroad Company, and the New York, Ontario & Western Railroad Company, and from 70 to 75 per cent. of the annual supply of anthracite coal in the United States is, and for many years past has been, produced either directly by said companies, as in the case of the Delaware, Lackawanna & Western Railroad and Delaware & Hudson Companies, or through the agency of the said 'subsidiary' coal companies."

Such facts may have been ground in the mind of Congress to justify restricting transportation regulations, when it saw that these private acquisitions by public carriers, up to 90 per cent. of the entire anthracite supply, had resulted from the mere inaction of Congress to restrict carriers in their interstate relations to their public and primary service of transportation. The facts set forth in this answer disclose a greater and more significant absorption than that in the English case, of which the Supreme Court, in *New Haven Railroad Company v. Interstate Commerce Commission*, supra, said:

"Here it is unquestioned that the Chesapeake & Ohio, as a result of its being a dealer, had become long prior to the adoption of the interstate commerce law, and continued to be thereafter, up to the passage of the West Virginia statute prohibiting a carrier from dealing in coal, virtually the sole purchaser and seller of all the coal produced along the line of its road. That this result was not merely accidental, but was in effect engendered by the power of the carrier to deal and transport a commodity, is illustrated by the case of *Attorney General v. Great Northern Railway Company*, 29 *Law Journal* (N. S. Equity) 794."

But, apart from authoritative statements, it must be clear to thoughtful men that the conduct of a carrier is the most vital and essential requisite to fair enjoyment of the benefits of commerce. Such being the case, it is equally clear that to be effective the power to regulate commerce must include ability to regulate the carrier, for to exclude it strips the power to regulate of all remedial strength. Regulation of the carrier, then, being essential to the power to regulate commerce, and the regulation of commerce between all states being delegated by the Constitution to the United States, it follows that any control or regulation of a carrier by a state, which affects the performance of the carrier's interstate service, is unconstitutional. "In a large proportion of the cases in respect to interstate commerce brought to this court," say the Supreme Court in *Re Debs*, 158 U. S. 564, 15 Sup. Ct. 900, 39 L. Ed. 1092, "the question presented was of the validity of state legislation in its bearings on interstate commerce, and the uniform course of decision has been to declare that it is not within the competency of a state to legislate in such a manner as to obstruct interstate commerce."

It is clear, therefore, that if the act now before us, which makes it "unlawful for any railroad company to transport from any state * * * to any other state * * * any article or commodity * * * manufactured, mined, or produced by it," etc., had been passed, for example, by the state of Pennsylvania, it would be unconstitutional, because, by circumscribing the carrier's power and regulating its duty in the interstate carriage of commerce, that state exercised power to regulate commerce between states, which the Constitution committed to the United States. We are not, therefore, embarrassed, in this case, by any question of trenching on the right of a state. Such being the case, one of two results must follow—either the right to regulate the interstate carrier's efficient performance of duty rests in Congress and its regulation must prevail, or no power to regulate interstate carriers exists, and the carriers "are a law unto themselves." Unfortunate as this would be, yet the nonexistence of a power affords no ground for vesting such power in Congress. But there is neither warrant nor necessity for such fallacious reasoning. The federal power rests on the sound and sufficient warrant of the Constitution itself, which gave the United States the power to regulate commerce between all the states. There is no mistaking the Constitution's plain words. The power to regulate means sufficient power to effectually regulate, for, as said by Chief Justice Marshall, in *McCulloch v. Maryland*, 17 U. S. 411, 4 L. Ed. 579:

"The Constitution of the United States has not left the right of Congress to employ the necessary means for the execution of the powers conferred on the government to general reasoning. To its enumeration of powers is added that of making 'all laws which shall be necessary and proper for carrying into execution the foregoing powers, and all other powers vested by this Constitution in the government of the United States, or in any department thereof.'"

Now it would seem idle for practical men to discuss the question whether regulation of the carrier to insure performance of its duty is not vital to the regulation of commerce. In the very nature of things the right of the people of one state to market their products in another, and the corresponding right of the people of the latter to enjoy the products of the former, cannot be mutually enjoyed unless there be some regulating power over the carrier who performs the interstate service. Seeing, as said by Mr. Justice Peckham in *United States v. Joint Traffic Association*, *supra*, "the business of a railroad carrier is of a public nature, and in performing it the carrier is also performing to a certain extent a function of government, which requires them to perform the service upon equal terms to all," by whom shall the requirement be made, unless by Congress, and on whom, except upon the carrier? And, clearly, the general power to forbid a public carrier from doing what hinders its performance of a public duty could not, before the Constitution, be denied to a sovereign state, for "the states were, unquestionably, supreme," says Mr. Justice Johnston in *Gibbons v. Ogden*, *supra*, "and each possessed that power over commerce which is acknowledged to reside in every sovereign state." When, then, all the states and the people thereof granted to the United States the broad power to regulate commerce between the

states, did the incident to such power, namely, control of the carriers of such commerce, cease to exist, or did it pass to the nation as an incident to the general power? If the sale of a vessel vests in the new owner the right to thereafter control engine and rudder, without mention of such power in the bill of sale, there can be no doubt that the grant of the general power to regulate commerce carried with it the right to regulate the carriers thereof as agencies of commerce.

It is no answer to this to say that sufficient power to regulate and control exists in Congress in forbidding rebates and enforcing uniform rates. To concede to Congress power to regulate carriers by such means is to concede it power to regulate by other means. For whether regulation is best exercised by punishing past, or by removing incentives to future, unfairness, is a question that concerns the exercise, but not the existence, of the power. Power to regulate commerce was held in the safety appliance cases—*Johnson v. Southern Pacific Company*, 196 U. S. 1, 25 Sup. Ct. 158, 49 L. Ed. 363—to justify regulations for safety devices upon carriers' cars, and if the power to regulate cars is an incident to the general power to regulate commerce, the power to make the carriers themselves efficient agencies of commerce cannot be gainsaid. Regulation of interstate carriers in the manner provided by this act invokes no new principle and subjects them to no other condition than that impliedly assumed by every one who enters upon a public duty, viz., that so far as private right interferes therewith it must be foregone. The right to contract belongs to every citizen; but, when a citizen becomes a member of Congress, all right to contract with his government is, by Rev. St. § 3739 (U. S. Comp. St. 1901, p. 2508), denied him. The profession of law has been held a right of which one may not be deprived by legislation, but only by decree of court. *Ex parte Garland*, 71 U. S. 333, 18 L. Ed. 366. But, when a lawyer becomes a federal judge, the law by Rev. St. § 713 (U. S. Comp. St. 1901, p. 578), forbids him the right to use his property and practice his profession. Such prohibitions are not restrictions of liberty or deprivations of property. They are the law's aids to public service. They make the public servant have an eye single to the public duty, voluntarily assumed, and in forbidding legislators, judges, and public carriers alike to act in a dual capacity the law but throws around them the time-proved safeguard of faithful service that "no man can serve two masters."

It remains to notice the objection that timber was excepted from the interdicted commodities. Reflection will show that, so far as the evils sought by this law to be cured are concerned, timber differed greatly from coal. Apart from the grants of timber lands to pioneer transcontinental roads along their rights of way, our attention has been called to no public carrier dealing in and transporting timber. Nature has prevented this. Forests make streams, and water, from its nearness, and timber, from its capacity to float, make water transportation timber's natural outlet. It is impossible, therefore, for any land carrier to become such a private carrier of its own timber as to affect its duty as a public carrier, and a railroad so quickly exhausts

the forests tributary to it that it could not long remain a distinctive timber road.

Satisfied, then, of the three propositions, namely, first, that under the Constitution the power to regulate commerce between the states is vested in Congress; secondly, that such power includes the power to regulate carriers thereof; and, thirdly, that the divorce of the dual relation of public carrier and private transporter is a regulation of commerce—I hold this law is constitutional, and from the opinion of the majority to the contrary I record my dissent.

UNITED STATES v. SOMERS.

(District Court, S. D. California, S. D. August 31, 1908.)

No. 39.

POST OFFICE—MAILING NONMAILABLE MATTER—INDICTMENT—"THING."

An indictment under Rev. St. § 3893, as amended by Act July 12, 1876, c. 186, 19 Stat. 90, and Act Sept. 26, 1888, c. 1039, 25 Stat. 496 (U. S. Comp. St. 1901, p. 2658), for mailing a letter giving information where and how and of whom and by what means articles and things designed and intended for the procuring of an abortion might be obtained, states an offense, where it sets out a letter written to defendant inquiring for some medicine or other means for accomplishing such result, and a letter, alleged to have been mailed by defendant in reply, which, when read in connection with the letter of inquiry, in effect offers for a stated consideration to effect the desired result by some treatment or operation, although the particular means is not specified; the word "thing," as used in the statute, being a comprehensive term, which includes any kind of treatment or operation.

[Ed. Note.—For cases in point, see Cent. Dig. vol. 40, Post Office, § 70.

For other definitions, see Words and Phrases, vol. 8, p. 6957.]

On Demurrer to Indictment.

The indictment alleges that the defendant on the 17th day of February, 1908, received a letter, of which the following is a copy, viz.:

"Escondido, Cal., Feb. 19, 1908.

"Dr. George C. Somers, Los Angeles, Cal.—Dear Doctor: I noticed your ad. in the Times, and think you can be of assistance to us, or rather my wife, in a professional way. She is about six weeks along in the family way, but she is determined not to have a baby. Have you any kind of medicine or something we can use here at home by directions you give, and which will keep her from having a baby? How much will it cost sent to me by express? If not, will she have to go to Los Angeles for some kind of operation? Have you some private place where she could stay while getting well? What will your charges likely be in that case? Please advise soon what is best to do.

"Confidentially yours,

[Signed] Wm. A. Bender."

The indictment further alleges that said defendant, in response to said letter hereinabove set forth, did deposit in a United States post office a certain letter giving information directly and indirectly as to how, when, where, of whom, and by what means certain divers articles and things designed and intended for the procuring of abortion (a particular description of which said articles and things is to the grand jurors unknown) might be obtained, which said letter is as follows:

"2/18—08.

"Mr. Wm. A. Bender, Escondido, Cal.—Dear Sir: Yours of the 15th inst. received and contents noted. In reply I will state that I can do nothing for

your wife unless she comes to Los Angeles. There is no medicine that I know of that will bring about the results you desire. She would have to remain here a week or ten days. The expense would be forty to sixty dollars, not more. Such accommodations as she would need can be had. In some cases results can be gotten in twenty-four to forty-eight hours; in others, three or four days might be required.

"Yours respectfully,

Geo. C. Somers."

Oscar Lawler, U. S. Atty., and A. I. McCormick, Asst. U. S. Atty.

W. J. Hunsaker, for defendant.

WELLBORN, District Judge (after stating the facts as above). First. The indictment is not defective because of its failure to specify the articles or things about which defendant's letter is alleged to have given information. In this respect the allegations here are the same as in *Lee v. United States*, 156 Fed. 948, 84 C. C. A. 448, where, as appears from those unreported parts of the record in the Court of Appeals which were used by the government at the oral argument on this demurrer, the precise point was raised by demurrer and urged by plaintiff in error in his brief. Among other grounds of demurrer were the following:

"(5) That said indictment does not state facts sufficient to constitute the offense of giving information to the person therein named, or to any person, where and how, and of whom, and by what means divers articles and things designed and intended to prevent conception might be obtained, for said written letter does not contain any statement referring to any article or thing designed or intended to prevent conception or for the procuring of abortion. * * *"

"(7) That said indictment is uncertain, in this: That it states that said written letter, alleged to have been deposited by the defendant in the post office establishment of the United States, gave information where and how, and of whom, and by what means divers articles and things designed and intended for the prevention of conception or for the procuring of abortion might be obtained, but it fails to state what articles or things for such purpose might be obtained; and said alleged offenses are not charged with precision and certainty, in not showing what the articles or things were, or how or in what manner the same were to be used, nor does it allege that the defendant intended the same to be used for either of the purposes alleged.

"(8) The said indictment is ambiguous, in this: That it fails to state what articles or things were to be furnished or used, or the manner of their use, in order to accomplish either the prevention of conception or the procuring of abortion."

In support of the ground of demurrer set forth in the last two paragraphs, the brief says:

"Now there is nothing at all designated in this letter, nor in the indictment, to show what the articles or things were or what they were intended for."

Said case must be accepted as authoritative here, and it is not, therefore, necessary for me to review *United States v. Pupke* (D. C.) 133 Fed. 243, or the decisions of any other District Courts.

Second. The ruling in *United States v. Whittier*, 28 Fed. Cas. 591 (No. 16,688), that the statute against mailing obscene books, etc., does not extend to the case of a letter written by the defendant to a person who had no existence, in answer to a decoy letter of a detective, and

which, on its face, gives no information of the prohibited character, has been disapproved by the Supreme Court in *Grimm v. United States*, 156 U. S. 604, 15 Sup. Ct. 470, 39 L. Ed. 550, and hence, if said facts were shown here by the indictment, which I hardly think is the case, still the indictment would not, on that ground, be bad.

Third. That part of the statute (section 3893, Rev. St. [U. S. Comp. St. 1901, p. 2658]) which prohibits mailing of any letter giving information concerning articles or things designed or intended to procure abortion is not limited to physical substances capable of transmission through the mail, but includes treatments and operations, indeed, everything, whether material or ideal, designed or intended for the purpose above stated. I have examined the original act to which counsel for defendant invited attention, namely, Act March 3, 1873, c. 258, 17 Stat. 599, and think that statute rather confirms than militates against the views which I have expressed. It will be observed that in the first section of the act the words employed are "any drug or medicine or article whatever," while in the second section of the act the corresponding words used are "any article or thing." Obviously the word "thing" was added in section 2 to broaden its scope. The Century Dictionary in one clause defines the word "article" thus:

"6. A material thing; as, part of a class, or, absolutely, a particular substance or commodity; as, an article of merchandise. * * *"

It was doubtless in this sense that the word "article" was used in the first and second sections. The word "thing" is defined by the Century Dictionary thus:

"That which is or may become the object of thought; that which has existence, or is conceived or imagined as having existence; any object, substance, attribute, idea, fact, circumstance, event, etc. A thing may be material or ideal, animate or inanimate, actual, possible, or imaginary."

Thus it will be seen that the word "thing" has a far wider significance than the word "article," and there could have been but one purpose for adding it in the second section, and that was, as I have already indicated, to broaden the scope of the section.

It is true that the title of the act, which is "An act for the suppression and prevention of the circulation of obscene literature and articles of immoral use," does not indicate the objects of the second section with the same fullness as it does those of the first section; but it is only in case of ambiguity that the title of an act may be resorted to in aid of its interpretation, and, moreover, the title can never be used to extend or restrain or control positive provisions or express words in the statute. *Holy Trinity Church v. U. S.*, 143 U. S. 457, 462, 463, 12 Sup. Ct. 511, 36 L. Ed. 226; *White v. U. S.*, 191 U. S. 545, 550, 24 Sup. Ct. 171, 48 L. Ed. 295. See, also, 26 Amer. & Eng. Ency. of Law, p. 2629.

The language of the section as it now stands in the Revised Statutes, so far as pertinent here, is:

"Every obscene * * * book, * * * and every article or thing designed or intended for the * * * procuring of abortion, and every * * * letter * * * giving information directly or indirectly where or how or of whom or by what means any of the hereinbefore mentioned matters, articles

or things may be obtained, * * * are hereby declared to be nonmailable matter," etc.

While the letter charged to have been written by the defendant states that he knows of no medicine that will bring about an abortion, yet, when read in connection with the letter of inquiry to which it was a reply, it does in effect inform the addressee that the defendant has at his command in Los Angeles some sort of means for the procuring of an abortion, although the means are not specified. It may be fairly conceded, however, that the means referred to were, as contended by defendant's counsel at the oral argument, and using the language of the letter of inquiry, "some kind of operation." The Century Dictionary, in one clause, defines "operation" thus:

"The course of action or series of acts by which some result is accomplished; process. (a) In surg., the act or series of acts and manipulations performed upon a patient's body, as in setting a bone, amputating a limb, extracting a tooth, etc."

Manifestly an "operation" is a "thing" within the accepted definitions of the two words, and there is no peculiar phraseology in the statute which restricts the ordinary signification of the word "things." The participle of the verb phrase "may be obtained" is not limited in its use to the acquisition of material substances, but is coextensive with the word "things," and can be suitably used to designate the attainment of whatever one may desire. "Obtain" is defined, in one clause, by the Century Dictionary, as follows:

"I. trans. 1. To get; procure, secure, acquire; gain; as to obtain a month's leave of absence; to obtain riches.

"II. intrans. 1. To secure what one desires or strives for; prevail; succeed."

The word "procure," embraced in the definitions of "obtain," is defined by same authority thus:

"2. To bring about by care and pains; effect; contrive and effect; induce; cause; as, he procured a law to be passed."

"Treatment," which has been held by the Circuit Court of Appeals for this circuit to be within the statute (Lee v. United States, supra), is defined in the Century Dictionary thus:

"The act or the manner of treating in any sense."

The verb "treat" is defined by the same authority, in one paragraph, thus:

"7. To manage in the application of remedies; as to treat a fever or a patient."

In view of said decision, and the various definitions above given, I am satisfied that an "operation" is a "thing" within the letter, as it admittedly is within the spirit, of the statute.

The demurrer will be overruled

KANeko v. ATCHISON, T. & S. F. RY. CO. et al.

(Circuit Court, S. D. California, S. D. August 31, 1908.)

No. 1,345.

DEATH—ACTION FOR WRONGFUL DEATH—SCOPE OF STATUTE.

Nonresident aliens are entitled to the benefit of Code Civ. Proc. Cal. § 377, which provides that "when the death of a person, not being a minor, is caused by the wrongful act or neglect of another, his heirs or personal representatives may maintain an action for damages against the person causing the death."

[Ed. Note.—For cases in point, see Cent. Dig. vol. 15, Death, § 37.]

At Law. On demurrer to complaint.

Byron Waters, for plaintiff.

A. S. Halsted, for defendant San Pedro, L. A. & S. L. R. Co.

WELLBORN, District Judge. This is an action brought by an administrator to recover damages for the death of his intestate, at the time a resident of Riverside county, Cal., alleged to have been occasioned through the negligence of the defendants. The heirs are a widow and three children, subjects of the emperor of Japan and residents of that country, and neither of whom has ever been in the United States. The abstract and only question raised by the demurrer is whether or not, under section 377 of the Code of Civil Procedure of California, nonresident aliens, who are heirs of the deceased, can maintain the action therein provided for. Said section, as far as pertinent here, is as follows:

"When the death of a person, not being a minor, is caused by the wrongful act or neglect of another, his heirs or personal representatives may maintain an action for damages against the person causing the death. * * *"

The Supreme Court of California has not passed upon the question, and the decisions construing similar statutes outside of this state are inharmonious. The cases denying the right of action are as follows: *Deni v. Railroad Co.*, 181 Pa. 525, 37 Atl. 558, 59 Am. St. Rep. 676; *Maiorano v. B. & O. Ry. Co.*, 216 Pa. 402, 65 Atl. 1077, 116 Am. St. Rep. 778; *McMillan v. Spider Lake, etc., Co.*, 115 Wis. 332, 91 N. W. 979, 60 L. R. A. 589, 95 Am. St. Rep. 947; *Brannigan v. Union Gold Mining Co. (C. C.)* 93 Fed. 164; *Roberts v. Great Northern Ry. Co. (C. C.)* 161 Fed. 239; *Zeiger v. Pa. R. Co. (C. C.)* 151 Fed. 348; *Adam v. British, etc., S. S. Co.*, [1898] 2 Queen's Bench Div. 430. The cases upholding the right of action are the following: *Mulhall v. Fallon et al.*, 176 Mass. 266, 57 N. E. 386, 54 L. R. A. 934, 79 Am. St. Rep. 309 (in this case, it should be noted, the opinion was delivered by Holmes, Chief Justice of Massachusetts, now one of the Associate Justices of the United States Supreme Court); *Pittsburgh, etc., R. Co. v. Naylor*, 73 Ohio St. 115, 76 N. E. 505, 3 L. R. A. (N. S.) 473, 112 Am. St. Rep. 701; *Philpott v. Mo. P. R. Co.*, 85 Mo. 164, 167; *Chesapeake, O. & S. W. R. Co. v. Higgins*, 85 Tenn. 620, 622, 4 S. W. 47; *Augusta R. R. Co. v. Glover*, 92 Ga. 132, 142, 143, 18 S. E. 406; *Kellyville C. Co. v. Petraytis*,

195 Ill. 215, 63 N. E. 94, 88 Am. St. Rep. 191; *Luke v. Calhoun Co.*, 52 Ala. 115; *Szymanski v. Blumenthal* (Del.) 3 Pennewill, 558, 52 Atl. 347; *Romano v. Capitol City B. & P. Co.*, 125 Iowa, 591, 101 N. W. 437, 68 L. R. A. 132, 106 Am. St. Rep. 323; *Tanas v. Municipal G. Co.*, 88 App. Div. 251, 84 N. Y. Supp. 1053; *Bonthron v. Phoenix L. & F. Co.*, 8 Ariz. 129, 71 Pac. 941, 61 L. R. A. 563; *Renlund v. Commodore M. Co.*, 89 Minn. 41, 93 N. W. 1057, 99 Am. St. Rep. 534; *Pochahontas C. Co. v. Rukas*, 104 Va. 278, 51 S. E. 449; *Vetaloro v. Perkins* (C. C.) 101 Fed. 393; *Davidsson v. Hill*, [1901] 2 King's Bench Div. 606.

The argument used in the early cases in support of defendants' contention that nonresident aliens are excepted from the statute seems to be as follows: The right of action for the death of a person did not exist at common law, and is purely statutory. Such statutes have no extraterritorial force, and are presumed to operate only between and upon citizens of the states respectively enacting them, and not in any way to affect the rights of foreigners, either by way of restricting or augmenting their natural rights. To include nonresident aliens is against the spirit and policy of the statutes. These statutes are based upon Lord Campbell's act, and no English case holds that said act extends to nonresident aliens. *Deni v. Penn. R. Co.*, 181 Pa. 525, 37 Atl. 553, 59 Am. St. Rep. 676, decided May 27, 1897, summarized the argument as follows:

"No case has been cited to us, nor are we aware of any, in which a nonresident alien, whether husband, widow, child, or parent of the deceased, has maintained a suit, under the act of April 26, 1855 (P. L. 309), to recover damages for an injury causing death. Our legislation on this subject is in accord with the English statute of August 26, 1846, and therefore the decisions of the English courts construing this statute are often referred to in cases grounded upon our acts of April 15, 1851 (P. L. 674, § 19), and April 26, 1855 (P. L. 309). But no case has been brought to our notice in which an English court has held that a nonresident alien is entitled to the benefits conferred by the act of 1846. The same may be said of the decisions of the courts of our sister states having statutes similar to our own. * * * Our statute was not intended to confer upon nonresident aliens rights of action not conceded to them or to us by their own country, or to put burdens on our own citizens to be discharged for their benefit. It has no extraterritorial force, and the plaintiff is not within the purview of it. While it is possible that the language of the statute may admit of a construction which would include nonresident alien husbands, widows, children, and parents of the deceased, it is a construction so obviously opposed to the spirit and policy of the statute that we cannot adopt it. * * * There is nothing on the face of the act which limits the protection afforded by it to our own citizens. It is referred to as another illustration of the general rule that we do not legislate beyond our jurisdiction."

These views, it seems to me, and as will appear later on, could never have been otherwise than inconclusive, and now carry even less weight than when they were first expressed. The statute of California (section 377 of the Code of Civil Procedure above quoted) contains no language excluding nonresidents or aliens from its operation, but, without any restrictive phraseology, confers a right of action upon the heirs of the deceased. It is difficult to find words more comprehensive or unequivocal than those the statute employs. Nor is there anything in the nature or objects of the statute which jus-

tifies the exception claimed by defendants. On the contrary, quoting from *Szymanski v. Blumenthal*, *supra* :

"The history, genius, and policy of our institutions, as well as the general development of the resources and industries, and the steady growth of the population and material prosperity of our state and nation, to say nothing of the enlightened progress of the age, seem to be against such a rule. In this case it is admitted that the plaintiff's husband lost his life from an injury occurring to him whilst actually engaged in our city and state in behalf of one of our industrial establishments. The plaintiff sues to recover damages for the injury she has suffered by her loss of his aid in supporting her and supplying her daily wants, etc. If he lost his life whilst here contributing to the development of the industries and to the progress and welfare of our state and country, it seems but just and reasonable that our state should allow his widow the use of its appropriate judicial tribunal and mode and means of redress for the wrong and injury shown to have been done to her within its limits by its own citizens."

In *Renlund v. Commodore Mining Company*, 89 Minn. 41, 47, 93 N. W. 1057, 1059, 99 Am. St. Rep. 534, the court says :

"Turning, now, to the language of our own statute, there is not a word or expression indicating an intention to limit its application to persons residing within the state, or to residents of sister states. The object of the statute was to remedy the harshness of the common law, and in some degree compensate those dependent upon the person killed. It would indicate an unnatural and selfish motive to draw a distinction between the dependent relatives who reside in another state or foreign government and those residing in our own state; and, unless such intention is manifest, we are not at liberty to assume that the lawmakers were legislating upon any such basis. As stated by the learned Chief Justice in *Mulhall v. Fallon*, *supra*, it is well known that a large percentage of the laborers who come within the borders of the state to seek employment leave their families and relatives behind. We think it is more in accordance with the spirit of the age that this statute be construed to have a universal application, and that it is intended to restore to the dependent, wherever the place of residence, in some degree, compensation for a loss resulting from an act of negligence committed within the state."

In *Bonthron v. Phoenix Light & Fuel Co.*, 8 Ariz. 129, 71 Pac. 941, 61 L. R. A. 563, 566, the court says :

"We do not think that, in order to entitle an alien to maintain this action, specific authority therefor must be granted such alien by the Legislature. The act is broad and comprehensive, and by its terms includes any surviving husband, wife, child, or parent, irrespective of their residence or citizenship; and this includes aliens, in the absence of any restrictive legislation. We know of no rule of law that prohibits the Legislature from extending such rights to nonresident aliens, or prevents their accepting the same. As Mr. Chief Justice Holmes said, in effect, *supra*, legislative power is territorial, and restricted thereto only so far as it imposes duties on persons outside its jurisdiction, and not in so far as it confers benefits. The object of the act is to extend beyond the limits of the common law the right to recover reparation for a wrong, and we fail to see why, the wrong having been committed, the same reparation should not be made, whether those entitled to it are citizens of a state of our Union, or citizens of that country whose law we have inherited, and whose legislation in this instance we have adopted. In the absence of any constitutional provision, the same principle under which we extend this right to citizens in other parts of our country beyond our territorial limits having the same law in force applies to its extension by us to citizens of another country having the same law in force. An alien can maintain in our courts an action to enforce rights cognizable at common law. A statute authorizing a right of action, if declaratory merely of the common law, in the absence of a specific restriction, would not exclude aliens, or prevent them from availing themselves of its benefits. There is no difference in principle between such a case and a

statute which grants rights not cognizable at common law, or extends rights beyond the limits fixed by the common law. In the absence of a specific restriction, the Legislature must be presumed, by its enactment enlarging rights common to all, to have intended that such enlargement of rights be common to all. We think the doctrine cited by counsel for defendant in error by the Supreme Court of Pennsylvania in McCarthy's Appeal, 68 Pa. 217: 'We do not legislate for men out of our jurisdiction'—is not one that commends itself, or is in accord with the spirit of our age or our institutions, and should not be inferred or read into a statute which in its terms is broad and comprehensive, and contains no suggestion of limitation as to citizenship or residence. A construction of such a statute with respect to its application to rights of aliens thereunder, which will include such aliens, is more in accord with the liberal policy of our government, and the decisions of our courts in regard to the enforcement of their rights, when they grow out of or are connected with commercial interests or business relations."

To the same effect is the following extract from "case note" in Pittsburgh, etc., R. Co. v. Naylor, 73 Ohio St. 115, 76 N. E. 505, 3 L. R. A. (N. S.) 473, 112 Am. St. Rep. 701:

"To deny the right to maintain an action for negligent injuries resulting in death, under a statute broad enough to cover every case of negligent killing, simply on the ground that the beneficiaries of the action are nonresident aliens, seems contrary to the policy and spirit of our institutions and the purpose for which such statutes have been enacted. Since the object of an act giving a right of action for injuries causing death is to supply an omission in the common law, and to provide reparation for a wrong for which at common law there was no redress, it is difficult to see why, such wrong having been committed, the same reparation should not be made, whether those entitled to it are citizens of the United States or of some other country. The purpose of such legislation is the protection of those who suffer pecuniary loss by the death of a person resulting from the negligence of another, and the manifest intention of the Legislature is that a person guilty of such negligence shall not escape the consequences of his act by the death of the victim of his negligence, as he did at common law, but shall respond in damages to those who have suffered pecuniary loss thereby; and, as stated in *Alfson v. Bush Co.*, 182 N. Y. 393, 75 N. E. 230, 108 Am. St. Rep. 815: 'It is difficult to conceive of any argument, springing from public policy, sound reason, or a proper discrimination between the rights of the citizen and the alien, that should prevent the alien husband, wife, or next of kin of a laborer killed by reason of his employer's negligence from receiving those damages that a jury has awarded a local legal representative. * * * The damages are imposed upon a negligent employer as compensation to those who suffer by his act, and there is no valid reason, as it seems to us, why they should not be paid to the survivors, whether residing here or in some foreign jurisdiction. The statute not only benefits the survivors, but protects the laboring man, as it tends to enforce observance by the employer of the rule requiring him to furnish the servant a safe place in which to work. * * * Throughout the last century the emigrants from many lands came to us in constantly increasing numbers, swelling the ranks of labor, and a majority of them ultimately attaining the dignity of citizenship. Many of these toilers in mines, on public works, railroads, and the numberless fields of manual labor, receive a moderate wage, and are compelled to leave in foreign lands those who are dependent upon them and for whose support they patiently work on, indulging the hope that ultimately they may bring to these shores a mother, or wife and children.'"

Alfson v. Bush Co., 182 N. Y. 293, 298, 75 N. E. 230, 231 (108 Am. St. Rep. 815), speaks to the same effect, as follows:

"The principal underlying the legislation we are considering is manifestly the protection of those who suffer pecuniary loss when a laborer or servant is killed by the negligent act of the individual or corporation employing him. The clear intention of the Legislature is that the negligent employer shall no longer escape the consequences of his act by the death of his servant, but shall

respond in damages to those who have suffered pecuniary loss. It is difficult to conceive of any argument springing from public policy, sound reason, or a proper discrimination between the rights of the citizen and the alien, that should prevent the alien husband, wife, or next of kin of a laborer, killed by reason of his employer's negligence, from receiving those damages that a jury has awarded a local legal representative, who derives his authority from and acts under the control of the Surrogate's Court. The damages are imposed upon a negligent employer as compensation to those who suffer by his act, and there is no valid reason, as it seems to us, why they should not be paid to the survivors, whether residing here or in some foreign jurisdiction. The statute not only benefits the survivors, but protects the laboring man, as it tends to enforce observance by the employer of the rule requiring him to furnish his servant a safe place in which to work. The laborer, leaving wife and children behind him and coming here from abroad has a right to enter into the contract of employment, fully relying upon the statute. The conflict of authority in England and our sister states leads us to deal with this question on principle and to base our answer to it on reasons that are weighty and controlling."

It is true that the case at bar does not involve the relation of employer and employé, nor is section 377 of the California Code limited to that relation; but it does include, with all other classes, employés whose deaths are negligently caused by the employers, and therefore the considerations based upon the relation of employer and employé, urged in the foregoing quotations, are as applicable here, the question being only a construction of the statute, as they would be to a case involving such a relation and brought under a special employer's liability act. To exclude nonresident aliens from the benefits of the section is to read into it a restriction which it does not contain, and to hold that employers may escape all liability to those engaged in their service for wrongful act or neglect by employing only alien laborers. The results of such a holding have been forcibly epitomized as follows:

"It is to refuse compensation to a certain class of persons for a real injury recognized by statute law. It is to relieve employers with respect to some employés from the exercise of due care in the employment of safe and suitable tools and machinery and competent superintendents. It is to offer an inducement to employers to give a preference to aliens and to discriminate against citizens. It is to hold that the Legislature of Massachusetts intended by this act to declare that employers should not be liable for the grossest negligence which results in the instant death of an alien employé in cases where his widow or next of kin happen to reside in a foreign country." *Vetaloro v. Perkins* (C. C.) 101 Fed. 394.

Surely such results condemn the construction from which they inevitably flow.

Another strange consequence of the doctrine contended for by defendants is illustrated in the English case of *Davidsson v. Hill*, [1901] 2 K. B. Div. 606, as follows:

"Here the plaintiff seeks to enforce her claim against an English subject, and I cannot see why she should not do so. If she has not the right, we should have the anomaly, as it seems to me, that, if a foreigner and an Englishman serving on the same ship were both drowned on the high seas by the same collision, negligently caused by an English vessel, the widow of the one could, and the widow of the other could not, obtain by suing the owners of the ship in fault in personam that reparation which our Legislature in those statutes has declared to be a just reparation."

From *Romano v. Capitol City B. & P. Co.*, 125 Iowa, 591, 592, 593, 101 N. W. 437, 438 (68 L. R. A. 132, 106 Am. St. Rep. 323) may be aptly quoted the following:

"Counsel for appellee contend that the statutory provision (Code, § 3443) that 'all causes of action shall survive and may be brought, notwithstanding the death of the person entitled or liable to the same,' should not be given extra-territorial effect, and should be so construed as not to confer a benefit upon nonresident aliens. It seems to us, however, that they misapprehend the scope of the generally recognized doctrine that statutes have effect only within the jurisdiction of the sovereign power by which they are enacted. It is not claimed that this statute is to have any force and effect in Italy. The accident happened in Iowa; the person injured, as well as the defendant, is a resident of Iowa; and the wrong done by defendant, if any, was done in Iowa. It is difficult, therefore, to see how it can be urged that any question of extraterritoriality arises. The contention for appellee seems rather to be that a nonresident alien is not to be regarded as a person entitled to the benefits of the Iowa statute, although he comes within the plain terms of its provisions. The argument recalls the theory of the old Roman law that laws are personal, rather than territorial, in their application; for, under the doctrine of the Roman civil law, a Roman citizen only could assert the rights and avail himself of the remedies recognized by that system, and aliens, even though they might be residents, must resort to a wholly distinct jurisdiction to secure redress for wrongs which they may have suffered. Muirhead, Roman Law, § 25. It is unnecessary to say that the theory of the common law in this respect is wholly different. Under the common-law theory, laws are territorial in their operation; and, while a sovereign may legislate with reference to its subjects outside of its territorial jurisdiction, general legislation is assumed to apply to all persons residing, all property situated, and all rights arising within its territorial jurisdiction, regardless of the status of the parties as being citizens or aliens. As to the rights arising or recognized within the jurisdiction, a nonresident alien may maintain suit in the courts without any special statutory authority. *Knight v. Railroad Co.*, 108 Pa. 250, 56 Am. Rep. 200; *Kellyville Coal Co. v. Petraytis*, 195 Ill. 215, 63 N. E. 94, 88 Am. St. Rep. 191; *Vetaloro v. Perkins* (C. C.) 101 Fed. 393. It would certainly strike the profession in this state as most extraordinary and unprecedented if we should hold that a nonresident alien could not, in the absence of express statutory authority, avail himself of a statutory remedy in our courts, such as that of an attachment or garnishment proceeding."

In line with this last suggestion, it may well be said that it would be a strange proposition in California to assert that the statutory liability of a stockholder does not inure to the benefit of a nonresident alien, although a creditor of the corporation.

Davidsson v. Hill, [1901] 2 King's Bench, 606, supra, is a decision in the same court with, but later than, *Adam v. British, etc.*, S. S. Co., [1898] 2 Queen's Bench, 430, cited in defendants' brief, and expressly dissents from that case, and answers the argument made in *Deni v. Penn. R. Co.*, supra, hereinbefore quoted, that no English case has been found holding that a nonresident alien is entitled to the benefits of Lord Campbell's act. On this point may be aptly quoted from the "case note" to *Pittsburgh, etc.*, R. Co. v. *Naylor*, supra, the following:

"Since the statutes of the various states giving a right of action for negligent killing are copied from Lord Campbell's act, the construction placed upon that act by *Adam v. British & F. S. S. Co.*, supra, doubtless greatly influenced the courts which denied the right of action in the earlier cases; and therefore the disapproval of that decision in the later case of *Davidsson v. Hill*, [1901] 2 K. B. 606, would seem to weaken, to some extent at least, the weight of those earlier decisions of the state courts."

In *Philpott v. Missouri*, *Chesapeake v. Higgins*, and *Augusta v. Glover*, *supra*, it is true that the party for whose benefit the action was brought was a resident of a sister state; but there is nothing in the reasoning of the courts, or upon principle, which would justify a denial of the remedy to an alien nonresident.

Other pressing demands upon my time will not allow me to further review in detail the cases above cited; but, after careful examination of them, I am of opinion that plaintiff's right to recover in this action, under section 377 of the Code of Civil Procedure of California, is supported by unanswerable reasoning and an overwhelming weight of authority.

Plaintiff, in his brief, rests his cause of action largely on the treaty between the United States and Japan (29 Stat. 848); but the conclusion which I have just announced renders it unnecessary for me to pass upon that contention.

The demurrer will be overruled, and defendant allowed to answer within 10 days.

UNITED STATES v. MOODY.

(District Court, W. D. Michigan, N. D. August 10, 1908.)

1. CANALS—REGULATION OF GOVERNMENT CANALS—DELEGATION OF POWER TO EXECUTIVE DEPARTMENT.

Act Aug. 18, 1894, c. 299, § 4, 28 Stat. 362 (U. S. Comp. St. 1901, p. 3525), which makes it the duty of the Secretary of War "to prescribe such rules and regulations for the use, administration, and navigation of any or all canals and similar works of navigation that now are or hereafter may be, owned, operated or maintained by the United States as in his judgment the public necessity may require," and makes a willful violation of such rules and regulations a criminal offense punishable as therein provided, impliedly forbids the use of canals owned by the United States, under penalty of criminal prosecution, except in compliance with such rules and regulations, and the delegation of power to make the same to an administrative department is constitutional.

2. SAME—REGULATIONS OF DEPARTMENT—VALIDITY.

Rule 8 of the regulations promulgated by the Secretary of War for the government of St. Mary's Falls Canal, owned by the United States, which provides that "the movements of all vessels, boats, or other floating things in the canal shall be under the direction of the superintendent and his assistants, whose orders and instructions must be obeyed," is within the authority conferred on him by statute to make regulations for the operation of all canals owned, operated, or maintained by the United States, and valid; and an order given by the superintendent, or an assistant, for the movement of a vessel, is but the carrying into effect of such rule, and not the making of a special rule, and the disobedience of such an order is a violation of the rule, made punishable as a criminal offense under the statute.

3. INDICTMENT AND INFORMATION—VIOLATION OF DEPARTMENT REGULATIONS—CRIMINAL LAW—EVIDENCE—JUDICIAL NOTICE.

Regulations made by an executive department in pursuance of authority delegated by Congress have the force of law, and the courts take judicial notice of their existence and provisions, and it is unnecessary to set them out in an indictment for their violation, or to specify the particular rule violated.

[Ed. Note.—For cases in point, see Cent. Dig. vol. 27, Indictment and Information, § 183.]

4. SAME—MOTION TO QUASH—SURPLUSAGE.

Surplusage in an indictment is not ground for quashing the same, in whole or in part.

On Demurrer to Indictment and Motion to Quash.

Wm. K. Clute, Asst. Dist. Atty., for the United States.

Richard Inglis, for respondent.

KNAPPEN, District Judge. The respondent is indicted for a violation of the rules and regulations adopted by the Secretary of War for the use, administration, and navigation of St. Mary's Falls Canal; the specific charge being that he knowingly and willfully disobeyed a lawful order of an assistant superintendent to tie up the steamer of which the respondent was master at a certain point outside the canal gates, and in such disobedience proceeded with his boat down the canal towards the locks, thereby colliding with and injuring another steamer and blocking the passage of vessels in the canal for a long period of time. The respondent demurs to the indictment upon the ground that the statute under which the rules and regulations were made is unconstitutional, in that it delegates legislative power to an executive officer, and that rule 8, hereafter referred to, is invalid, as exceeding the scope of the act. He also moves to quash the indictment upon the grounds, first, that it does not clearly specify how the respondent violated the rules; second, that it does not state which rule was violated; and, third, that the indictment contains matter immaterial and prejudicial to the respondent.

Section 4, c. 299, Act August 18, 1894 (28 Stat. 362 [U. S. Comp. St. 1901, p. 3525]), provides that:

"It shall be the duty of the Secretary of War to prescribe such rules and regulations for the use, administration, and navigation of any or all canals and similar works of navigation that now are, or that hereafter may be, owned, operated or maintained by the United States as in his judgment the public necessity may require. Such rules and regulations shall be posted in conspicuous and appropriate places, for the information of the public; and every person and every corporation which shall knowingly and willfully violate such rules and regulations shall be deemed guilty of a misdemeanor, and, on conviction thereof in any District Court of the United States within whose territorial jurisdiction such offense may have been committed, shall be punished by a fine not exceeding \$500.00, or by imprisonment (in the case of a natural person) not exceeding six months, in the discretion of the court."

By the rules and regulations adopted by the Secretary of War the canal was placed in charge of an engineer officer of the United States army, detailed by the Secretary of War; such officer to be locally represented by an assistant engineer, known as "canal superintendent." The rules provided for an additional force, consisting of three assistant superintendents and the necessary number of enginemen, watchmen, foremen, lockmen, and laborers; for the immediate control and management of the entire canal force by the superintendent, and in his absence or disability by the assistant superintendents; for a division of the remaining canal force into three watches, of eight hours each, consisting each of an assistant superintendent and the necessary enginemen, foremen, watchmen, lockmen, and laborers, who are re-

quired to act under the direction of the assistant superintendent "in passing vessels through the canal, in the care and protection of the canal and grounds, as well as of all other property belonging to the United States." The regulations for the use and navigation of the canal provide prescribed signals on the part of boats desiring the use of the canal, maximum length of tow line, order of precedence in passing through the canal and locks, regulations as to the limits of approach until the gates are ready for entrance, and rules for protecting the works from injury. Rule 8 provides:

"The movement of all vessels, boats or other floating things in the canal shall be under the direction of the superintendent and his assistants, whose orders and instructions must be obeyed."

Rule 19 provides:

"No person shall cause or permit any vessel or boat of which he is in charge, or on which he is employed, to in any way obstruct the canal, or delay in passing through it, unless he is permitted to do so by the superintendent or one of the assistant superintendents of the canal."

As to the constitutionality of the statute: It is elemental that Congress cannot delegate legislative authority to an executive officer or board, and that accordingly such executive officer cannot amend or extend a law of Congress, so as to make an act unlawful which but for the action of the executive officer would be lawful; in other words, that a sufficient statutory authority must exist for declaring an act or omission unlawful. *Morrill v. Jones*, 106 U. S. 466, 1 Sup. Ct. 423, 27 L. Ed. 267; *Field v. Clark*, 143 U. S. 649, 691, 12 Sup. Ct. 495, 36 L. Ed. 294; *United States v. Eaton*, 144 U. S. 677, 687, 12 Sup. Ct. 764, 36 L. Ed. 591. It is, however, equally elemental that Congress may constitutionally delegate to an officer or board the determination of a question of fact or state of things upon which the operation of the law is made to depend, or the regulating by administrative rules of the mode of procedure to carry into effect what Congress has otherwise enacted. *Field v. Clark*, supra; *Caha v. United States*, 152 U. S. 211, 14 Sup. Ct. 513, 38 L. Ed. 415; *In re Kollock*, 165 U. S. 526, 17 Sup. Ct. 444, 41 L. Ed. 813; *Buttfield v. Stranahan*, 192 U. S. 470, 24 Sup. Ct. 349, 48 L. Ed. 525; *Union Bridge Co. v. United States*, 204 U. S. 364, 27 Sup. Ct. 367, 51 L. Ed. 523. In the cases cited by counsel, where the courts have refused to enforce administrative rules adopted by an executive officer or board, it has been found that the regulation in question practically added to or amended the statute (as in *Morrill v. Jones*, supra; *United States v. Maid* [D. C.] 116 Fed. 650; *United States v. Hoover* [D. C.] 133 Fed. 950; *United States v. Matthews* [D. C.] 146 Fed. 306), or (as in *United States v. Eaton*, supra) that the punishment for violation of the regulation in question was not provided for by the statute, or that there was no express or necessarily implied authority from Congress to make regulations. Here authority to make regulations has been given in explicit terms, and the statute has expressly declared the violation of such rules to be a criminal offense.

The controlling question, then, is: Have the rules adopted by the Secretary of War attempted to make unlawful that which, but for

such rules, would have been lawful? In determining this question, the nature of the subject-matter under regulation must be considered. The statute relates to "the use, administration and navigation of any and all canals * * * owned, operated or maintained by the United States." The St. Mary's Falls Canal is not only operated and maintained by the United States, but is owned by the United States as proprietor. The history of the building and acquisition of this canal is given in *United States v. Michigan*, 190 U. S. 379, 23 Sup. Ct. 742, 47 L. Ed. 1103. Moreover, the canal in question, as is the case with all the canals operated and maintained by the United States government, is under the control of the military department of that government. It is beyond dispute that the United States has the power to exclude the public from the land and works of which it is the proprietor. *Camfield v. United States*, 167 U. S. 518, 524, 17 Sup. Ct. 864, 42 L. Ed. 260; *United States v. Ormsbee* (D. C.) 74 Fed. 207, 310; *Van Lear v. Eisele* (C. C.) 126 Fed. 823. And the fact that the canal is "free for public use" (that is to say, free of toll) does not impair the authority of the United States to forbid its use except upon compliance with reasonable regulations respecting such use. The case of *Camfield v. United States* involved public lands. In *Van Lear v. Eisele* it was held that Congress had the right to exclude the public from the Arkansas Hot Springs, except on terms prescribed by it, and that it might lawfully delegate to the Secretary of the Interior the power to make such regulations. *United States v. Ormsbee* will be referred to later.

Had the statute in terms forbidden the use of the canal, except under regulations adopted by the Secretary of War, the constitutionality of the delegation to that officer to make rules for its use and navigation could not well be doubted. In *United States v. Ormsbee* the identical statute here involved was in question. The regulation there under attack forbade the drawing of water from the Fox River Canal. Judge Seaman held that, as presumptively the rights in and control of the waters of the canal are vested in the United States, no persons can have the use either of the water or of the works, except under permission and subject to any regulations which may be imposed, and that without such permission the use would constitute trespass. He held that, even without the aid of another statute applicable in that case, which forbade the drawing off of water, no right existed to do the act complained of, in view of the statute here and there in question and of the ownership of the works by the United States government; that Congress had thus provided that permission might be granted through rules and regulations adopted by the executive department having charge of the works; and that, as Congress might so prescribe rules, it might equally well intrust to the Secretary of War a promulgation of administrative rules.

It is plain that the prohibition of the use of the canal and locks in question, except on compliance with rules governing such use and navigation, is absolutely necessary to any reasonable measure of protection to either the public or the proprietary government. That Congress ever contemplated the possibility of the unrestrained and unreg-

ulated use of the canal and locks by navigators according to their own will and caprice, and by their own operation, is practically unthinkable. To my mind, having in view the nature of the canal and its proprietary ownership by the United States, the absolute necessity of regulations, the history of its previous use, of which the court will take cognizance, and the language of the statute in question, a prohibition of the use of the canal, except upon compliance with the regulations provided for, is necessarily implied. In the language of Judge Lurton, speaking for the Circuit Court of Appeals for the Sixth Circuit in *Coopersville Co-operative Creamery Co. v. Lemon*, 163 Fed. 145:

"That which is plainly implied is as much the law as that which is expressed in plain terms."

The conclusion that the delegation in question is within the constitutional authority is further supplemented by the case of *United States v. Breen* (C. C.) 40 Fed. 402. In that case the question of the constitutionality of a regulation made by the Secretary of War respecting the navigation of the South Pass of the Mississippi river was involved. Congress gave authority to the Secretary of War to "make such rules and regulations for the navigation of the South Pass of the Mississippi river as to him seemed necessary or expedient for the purpose of preventing any obstruction to the channel through said South Pass and any injury to the works therein constructed." The statute provided a punishment identical to that imposed by the act here in question for the violation of any rule or regulation made by the Secretary of War in pursuance of the act. The rule involved in the *Breen* Case prescribed the speed of navigating vessels. Justice Lamar, sitting at circuit, held the act constitutional, as a delegation of power to the Secretary of War to fix rules for protecting improvements of the Mississippi. The implication of a prohibition against the navigation of the channel, except in obedience to regulations for its use, was no more direct in the *Breen* Case than in the case under consideration.

The conferring of power upon the Secretary of War to make rules for the use, administration, and navigation of the St. Mary's Falls Canal must be held valid.

The validity of rule 8 is attacked on the ground that the statute under which it is framed contemplates that the rules be general and published, while under the rule in question it is complained that the canal superintendent makes a new and specific rule each time he directs the movements of a vessel, and that such power is not and cannot be given. This contention, it seems to me, misconceives the term "rule," and overlooks the proprietary nature of the United States and its direct control, operation, and maintenance of the canal under the direction of the Department of War. The rules and regulations as adopted are all general. Rule 8 is no less general than each of the remaining 20. It applies to all cases alike. In a narrow sense the superintendent may be said to make a special rule each time he directs the movements of a vessel; but it is only in a narrow sense that such construction can be employed. The direction of the movements of each navigating vessel is really but a carrying into execution of the

general rule, and no more involves the making of a special rule in the case of each vessel than did the action of the tea inspector in *Buttfield v. Stranahan*, or that of the Secretary of War in *Union Bridge Co. v. United States*. The superintendent determines, in the case of each vessel, the question of fact as to what is, under the existing circumstances, a reasonable and proper movement of the vessel. This is not conferring arbitrary and capricious authority. Congress could not, by its own legislation, determine these questions of fact, and thus direct the movements of individual vessels in the canal and locks; and therefore, if this rule 8 is invalid, it follows that it is legally impossible to provide for the personal execution on the spot of the general rule, notwithstanding the United States is the proprietor and operator of the works, and this in the face of the fact that, for the proper administration of the canal and the protection of the United States in its use and administration, it is necessary that some one in authority should determine what each vessel should do, so that all can pass through without injury either to the boats of navigators generally, the vessels of the United States, which under the rules are given precedence over other vessels, or to the works themselves. If each master were at liberty to direct the movements of his own boat, not only would delays and confusion, and even injury to life and property, be constantly imminent, but the United States would be excluded from the operation of its own proprietary works. To appreciate this fact, one need only consider what is charged to have happened in the case complained of. It is no answer to say that the superintendent's power should be limited to warning and removing vessels which disobey the direction of the superintendent, as distinguished from punishment for disobedience. Such a remedy would, in the case of this canal, be no remedy at all. The superintendent could not physically remove the offending vessel in time to prevent injury to other vessels, and perhaps other lives, and possible serious injury to the canal works.

The cases cited by respondent's counsel do not, in my judgment, support his contention. In *Horn v. People*, 26 Mich. 221, there was no statute, ordinance, or rule placing the movements of vessels under the direction of the harbor master; nor was it charged that the offending vessel was impeding the rights of navigation. The charge was, as stated by the court:

"That the accused disobeyed an order of the harbor master to leave a private wharf, not on any ground of disorderly and obstructive conduct, but merely because the wharfinger did not want him there."

The court held:

"The state has no more right to assume protection of private wharfs than of private lots from encroachment."

In *Schaezlein v. Cabaniss*, 135 Cal. 466, 67 Pac. 755, 56 L. R. A. 733, 87 Am. St. Rep. 122, the proposition that one using the public waters of the state may do so only subject to such conditions as the state may impose is distinctly asserted. The other cases cited are thought to be distinguishable from the case at bar.

It must be held that disobedience to an order regularly given by an

assistant canal superintendent, in the absence of fraud or bad faith, is punishable under the statute.

It is urged that the indictment shows that the direction in question was given by a lockman, and that such workman has no power of direction. The indictment charges that the lockman was acting as assistant superintendent. This is a question of fact.

The point that the indictment does not clearly specify in what manner the respondent violated the rules does not seem to be well taken in fact. Nor is there force in the objection that the indictment does not state which rule was violated. Regulations made by an executive department, in pursuance of authority delegated by Congress, have the force of law, and the courts take judicial notice of their existence and provisions. It is therefore unnecessary to set out the rule alleged to be violated, either in terms or by number. *Wilkins v. United States*, 96 Fed. 837, 37 C. C. A. 588.

The statement in the indictment of the effect of the disobedience by the respondent of the order in question is not so far immaterial and prejudicial to the respondent as to justify action by the court. It may be surplusage, but such consideration does not justify the quashing of the indictment, in whole or in part.

The demurrer will be overruled, and the motion to quash denied, with leave to respondent to plead on the first day of the next term of court.

In re SYRACUSE PAPER & PULP CO.

(District Court, N. D. New York. October 5, 1908.)

1. BANKRUPTCY—ELECTION OF TRUSTEE—OBJECTIONS TO CLAIMS OF CREDITORS.

Where, at the first meeting of the creditors of a bankrupt, there was a contest over the election of trustee, oral unverified objections then made by the attorneys for one party to practically all of the duly proved claims of the other party, in support of which no proof was presented or offered, were not sufficient to require the referee to adjourn the meeting until such objections could be tried before proceeding with the election, and he properly overruled the objections.

2. SAME—RIGHT TO VOTE—STOCKHOLDERS AND EMPLOYÉES OF BANKRUPT CORPORATION.

That a creditor of a bankrupt corporation is a stockholder or director of the corporation, or was an employé, does not deprive him of the right to participate in the election of a trustee.

3. SAME—TRUSTEE—COMPETENCY.

Where three trustees are elected for a bankrupt corporation, it is no ground of objection that one of them is a director of the corporation; and, in case it becomes the duty of the trustees to bring an action against the directors, such action may be brought by the other two, making their co-trustee a defendant as director.

In Bankruptcy. Hearing on petition of review of order of C. L. Stone, referee in bankruptcy, approving the appointment by the creditors of the above-named bankrupt of Frank M. Bosworth, Frank P. Hakes, and George W. Driscoll as trustees of the estate of said Syracuse Paper & Pulp Company.

Benj. Stoltz, for six creditors.

Henry G. K. Heath, for J. S. and W. R. Eakins, creditors.

Hiscock, Doheny, Williams & Cowie, for trustees and other creditors.

RAY, District Judge. The petition in bankruptcy was filed in this case June 17, 1908, not August 17, 1908, as stated in the petition of review. On the same day, on all the papers and a full hearing and examination of Geo. W. Driscoll as to his connection with and relations to the alleged bankrupt, this court appointed Frank P. Hakes, of Cortland, N. Y., a person selected by the court because of his known integrity, long business experience, education, and good judgment, and entire disassociation with said alleged bankrupt and its officers, and said Driscoll, receivers of the estate of said paper and pulp company. I then was and still am of the opinion that some one fully acquainted with the operations and business of the company should be associated in the administration and winding up of its affairs. Soon thereafter, and early in July, an order was made for the examination of the officers of the alleged bankrupt and a full and complete inspection of its books and papers, to commence, as my recollection serves, July 20, 1908. This order was made on application of Mr. Stoltz, who represented certain creditors, including those, or some of those, who now object. This was done to enable a full discovery, so far as practicable, in advance of the election of a trustee. This afforded every opportunity to ascertain the real creditors of the bankrupt, etc. All the claims voted on and questioned here were included in the schedules and appeared on the books of the company. If there was valid objection to these claims in question here, or any one of them, it would have been easy to prepare in advance, or on the day of the first meeting of creditors, properly verified objections to the claims, which could have been filed on that day.

The first meeting of creditors was duly called and held on the 5th and 6th days of August, 1908. At that meeting there was a lively contest over the appointment of trustees. Three tickets were in the field. One ticket was for the appointment of three trustees, and the others for the appointment of one trustee. The minutes of the meeting show that some informal proofs were rejected; but no question is raised as to the propriety and legality of such action. One hundred and sixty-six votes were cast for each ticket, and Frank P. Hakes of Cortland, Frank M. Bosworth, of Watertown, and George W. Driscoll, of Syracuse, on one ticket, received 85 votes each, representing \$215,380.04 of the proved and allowed claims; William A. McKenzie, Jr., on another ticket, received 6 votes, representing \$12,806.-08; and Geo. D. Chapman, on another ticket, received 75 votes, representing \$112,173.52 of such claims. It is seen that Hakes, Bosworth, and Driscoll had a clear majority of 4 over all and a plurality of 10 over Chapman. The intelligence and general character and ability of Mr. Driscoll cannot be questioned. Hakes and Bosworth are pre-eminently fit for the place; Bosworth being skilled in the business he is to care for and settle, and Hakes having proved his abil-

ity and integrity while acting as receiver. From the fact that Heath and Stoltz represented creditors, or were able to control the votes of creditors, to the number of 75, it is evident they had been working up the election of Chapman. Mr. Heath, or Mr. Stoltz, or both, orally objected to the following claims: Hannawa Falls Water Power Co., \$7,299, on the ground it was a claim against other companies, or one of two other companies. Commercial National Bank, \$6,802.37, on ground it had, with knowledge of insolvency, received a preferential payment within four months. National Bank of Auburn, \$25,159.69, on same grounds. Salt Springs National Bank, \$7,563.69, on same ground. Salt Springs National Bank, \$9,139.50, same ground. Jefferson County National Bank, \$15,523, same ground. Utica Trust & Deposit Company, \$3,976.19, same ground. State Bank of Syracuse, \$77,181.15, same ground. Skaneateles Railway Company, \$1,920, on ground services were rendered to Rose & Moses Pulp & Paper Company. Rose & Moses Paper & Pulp Company, \$36,536.02, on ground it is not a provable claim, and bankrupt not indebted to it in any sum whatever. Pottsdam Paper Mills, \$3,941.46; George W. Phelps, \$1,792.25; George W. Phelps, \$575.75; G. Wittner, \$8,100.97; Battle Island Paper Company, \$12,585.99; John C. Lutz, \$2,840—and also numerous small claims, on the general ground, in nearly every case, that it was not a provable claim, and that alleged bankrupt was not indebted to the claimant in any sum, and frequently was added the objection that a preference had been paid and received with knowledge of insolvency. These general oral objections, not reduced to writing, or signed by any one, or verified, were made to substantially every claim voted in favor of Hakes, Bosworth, and Driscoil.

The objections having been made and overruled, no offer having been made to substantiate the objections by proof, and nothing appearing tending to impeach the validity of the claims, the referee announced that the election of a trustee was in order. Mr. Heath then objected to the election of a trustee on the ground that he had a right to have the claims to which he had objected, and where his objections were overruled, heard upon the evidence, and requested an adjournment for that purpose. This was an objection to proceeding to the election of a trustee without an adjournment. No evidence was offered to sustain the objections, and there was no claim made that evidence, if any, to sustain the objections was not then at hand. The referee ruled that to try out the objections would take more time than was at his disposal, and overruled the objection. This was equivalent to denying an adjournment for the purpose of trying the various and numerous objections on the merits. It was evident to the referee, and is evident to the court, that to have taken time to try out the question of the validity of these objections would have required weeks of time. The objections were not verified or reduced to writing. Evidently they were made at random and for purposes of delay. It was essential to the due administration of the estate that it proceed with reasonable diligence. The opportunity given for the examination of the officers and books of the company had developed nothing, so far as appears, against these claims. If so, that record could have been pro-

duced as a basis or ground for the objections. The claims, so far as allowed and voted upon, were regular upon their face and apparently valid. The claims stood proved, and were entitled to allowance, unless met and overthrown by proof. *Whitney v. Dresser*, 200 U. S. 532, 26 Sup. Ct. 316, 50 L. Ed. 584, and cases there cited.

But the allowance of a claim is not final; for if, at a later time, it is desired to open it and try out its validity, it can be done. And it is the duty of the referee and judge to afford such a rehearing on a prima facie case. True, the trustee or trustees represent the creditors, and this reopening of a claim is done by the trustees; but if a creditor, one or more, makes a prima facie case, and asks the trustee to take measures for the opening of a claim, and he refuses, an appeal to the referee or court would effect the desired result, and perhaps result in the removal of the trustee. The referee, in the absence of verified objections, and in the absence of any offer of evidence to sustain the oral objections made, overruled the objections in most instances and proceeded to obey the statute, which is imperative that the trustee shall be elected or appointed by the creditors at their first meeting. Bankr. Act, July 1, 1898, c. 541, § 44, 30 Stat. 557 (U. S. Comp. St. 1901, p. 3438):

"The creditors of a bankrupt shall, at their first meeting after the adjudication * * * appoint one trustee or three trustees of such estate. If the creditors do not appoint a trustee or trustees as herein provided, the court shall do so."

I do not doubt that it is competent for the trustee to adjourn this first meeting of creditors for a reasonable time, and from time to time when necessary, and in a proper case it is his duty so to do. But when it is apparent, as it was here, that certain attorneys in their own interest take it upon themselves to orally object to all, or substantially all, claims presented which may be voted against their nominee for trustee, and fail to file written and verified objections, or to offer then and there some evidence tending to support those made, and it is apparent that to try out the validity of such unsupported oral objections would unduly postpone the election of a trustee or trustees, it is the duty of the referee to obey the spirit and letter of the law and proceed with the election of a trustee. Any other course in such a case should not be tolerated. It is quite true that the creditors are to elect the trustee; but it is also true that at the first meeting they are to perform this duty, and that they should come prepared to act with reasonable expedition, and that these matters should not be dragged along on mere oral objections to verified claims apparently valid, and which are conceded by the bankrupt to be valid. And verified claims, presumptively valid, and which are entitled to probative force, which in effect prove themselves, should not be held up or denied allowance or participation in the election of trustees on mere oral objections in any case, unless some written evidence is placed before the court tending to impeach their validity, or some oral evidence is offered at the time having that tendency, or it is made to appear that such evidence exists, but cannot be then obtained and presented.

As the vote for trustee was being taken, objections were made to a vote being allowed on certain claims. The most of these objections, if not all, were clearly frivolous. A vote on the claim of Mr. Lattner was objected to on the ground that the claimant was an employé of the bankrupt company, and therefore not a proper person to vote for the election of a trustee. No such disability is imposed by the bankruptcy act or by common sense. It might be that two-thirds of the creditors of the bankrupt company were employés of the concern. Are they to be debarred from voting on the suspicion that they may have a friendly feeling for the company which has given them employment? A vote on the claims of John C. Lutz was objected to on the ground that he was a stockholder in the corporation, and not a proper person to unite in the selection of a trustee. A vote on the claims of G. Wittner were objected to on the same ground, with the addition that he was also a director. The law imposes no such disability on the creditor of such a corporation who happens to be a stockholder or director therein, and there is no valid reason why he should be debarred from voting for trustee. To be a stockholder in or attorney for a corporation may be a bar to his holding political office in the minds of those who would strike down corporate industries, or in the minds of political demagogues; but this socialistic doctrine has not yet been applied by the Congress of the United States to creditors of bankrupt corporations who have been so unfortunate or unwise as to become stockholders therein. Political preferment may be denied by the people to stockholders in corporations, and laws may be hereafter enacted which will deny property rights to that, now unfortunate, class of our citizens, as a punishment for association with corporations; but such disabilities are not yet written upon the statute books of these United States of America. This court declines to anticipate legislation in that regard. Cases may arise where the directors of a bankrupt corporation, also creditors thereof, may seek to control the election of the trustee in the interest of the bankrupt itself, and in opposition to the interests of the general creditors. In such a case I do not doubt that the referee or judge has the power to set aside such an election, if made; but it would be on other grounds than that the directors were not entitled to vote for the appointment of the trustee. In this case there was no combination of directors; no attempt to elect trustees in the interest of the bankrupt corporation. As stated, two of those elected and confirmed by the referee are men of the highest probity and business ability, and entirely disinterested; and the inclusion of Driscoll, familiar with all the books and affairs of the company, was wise and proper. Should he attempt to hide or cover the transactions, or balk proper legal proceedings, it would be ground of removal, and the referee should not hesitate to report the facts, and this court would speedily remove him.

It was suggested on the argument that there is a possibility that it will become the duty of the trustees to bring action against some or all the directors, including Driscoll, and that he, as trustee, cannot sue himself as director, or as an individual. There will be ample opportunity to cross that bridge when reached, if it ever is; but I am

of opinion that a trustee as such may be party complainant or plaintiff as such, and also defendant as an individual. In this case Hakes and Bosworth may prosecute all necessary actions, making Driscoll as director or personally, or even as trustee, a party defendant, stating the necessity for such action. 1 Foster's Fed. Pr. p. 148, § 42; Harding v. Handy, 11 Wheat. 103, 6 L. Ed. 429; Wisner v. Barnett, 4 Wash. C. C. 631, 642, Fed. Cas. No. 17,914; Barry v. Missouri, etc. (C. C.) 27 Fed. 1, per Wallace, J.

The creditors and all of them are at liberty to examine the directors, including Driscoll, and if it shall develop that he is an improper person to act as trustee, or that his presence as such interferes with the due and proper administration of the estate, he can be removed. No self-respecting court would hesitate a moment to take such action. There was a clear majority in number and amount voting for Hakes, Bosworth, and Driscoll. I have examined all the cases cited, and find nothing that would require, or even justify, the setting aside of their appointment. In fact, when the motion was made before the referee for the confirmation of the appointment or election made by the creditors, no objection was raised to either Hakes or Bosworth. It is not the policy of the law to hamper and delay the administration of the estates of bankrupts, but to expedite it. In the Matter of Cohen (D. C.) 131 Fed. 391, a large number of claims were objected to. The referee did not pass on them, but appointed a trustee himself. Held proper. In this case it is evident the referee, who confirmed the action of the creditors, would have appointed Hakes, Bosworth, and Driscoll. In Re Blue Ridge Packing Co. (D. C.) 125 Fed. 619, it was held that:

"The fact that one who is chosen by the creditors as trustee in bankruptcy advised the voluntary assignment under the state law which constituted the act of bankruptcy does not render him incompetent as trustee. * * * The fact that one who is chosen by a bankrupt's creditors as trustee had a law office with an attorney who represented certain stockholders of the bankrupt, who claimed to be creditors, but whose claims were to be contested, and that these persons were former clients of the trustee, and put their claims into his associate's hands at his suggestion, and that the trustee's election was with the aid of such persons, is insufficient to make his election an improper one, but merely calls for its close scrutiny. * * * The selection by a bankrupt's creditors of a trustee is not to be interfered with by the court, unless it clearly imperils the fair and efficient administration of the estate."

In some of the cases those proposing to vote for trustee have refused to answer pertinent questions tending to show that the trustee was being elected by their votes in the interest of the bankrupt concern, and not in the interest of the creditors. An election by such votes should not be sustained; but this case presents no such feature. In Re Eastlack (D. C.) 145 Fed. 68, Judge Lanning, after a review of the cases, at page 73, says:

"These cases establish the rule that the election of a trustee by the creditors is not to be disapproved, unless there is good reason for believing that the election has been directed, managed, or controlled by the bankrupt, or his attorney, or by some influence opposed to the creditors' interests. The proofs in this case show that at a large meeting of the creditors of Mr. Eastlack, called by him before he filed his petition in bankruptcy, he told them of his intention to file such petition, and of his belief that his assets, if wisely

disposed of, would exceed his liabilities, and then expressed the hope that he might be accorded the privilege of naming his trustee. On being asked whom he would suggest, he named Dr. Grace, who was thereupon nominated by one of the creditors, and to whom no objection was made. After he had filed his petition, his attorney, learning that some of the creditors were endeavoring to secure the election of another person as trustee, prepared a draft of the letter set forth in the referee's certificate. This letter was sent, it is true, 'to substantially all the creditors,' but not by the bankrupt or his attorney, but by and over the name of one of the creditors. The letter speaks, indeed, of Dr. Grace as the bankrupt's nominee. But neither the bankrupt nor his attorney attempted directly to control or influence the election. All that the bankrupt did, to which any objection is made, was to say in a public meeting of his creditors, and not privately to a limited number of friendly creditors, that he would like to have Dr. Grace as his trustee; and all that his attorney did was to prepare a draft of a letter which one of the creditors—a large creditor, having a claim exceeding \$5,100—sent to the other creditors recommending the election of Dr. Grace. Bankr. Act July 1, 1898, c. 541, § 44, 30 Stat. 557 (U. S. Comp. St. 1901, p. 3438), gives to the creditors the right to elect a trustee, and their election should be permitted to stand, unless it clearly appears that in conducting it some principle of law intended to secure the administration of the bankrupt's estate in the interest of the bankrupt's creditors has been violated."

I find nothing that indicates that these trustees, or any one of them, will be influenced in their action by anything aside from an honest and conscientious desire to promote the interests of the creditors and secure an honest and intelligent administration of the estate, and I am also satisfied that they are the choice of a majority in number and of a very large majority in amount of the honest bona fide creditors of the bankrupt.

The order of the referee, affirming the action of the creditors, is therefore approved and affirmed.

DAVIS v. DAVIS.

(Circuit Court, N. D. West Virginia. September 15, 1908.)

1. JUDGMENT—ACTION ON JUDGMENT OF ANOTHER STATE—DEFENSES—WANT OF JURISDICTION.

Neither the constitutional provision that full faith and credit shall be given in each state to the public acts, records, and judicial proceedings of every other state, nor the act of Congress passed in pursuance thereof, prevents an inquiry into the jurisdiction of the court by which a judgment offered in evidence was rendered, and the record of such judgment may be contradicted as to the facts necessary to give the court jurisdiction, either as to the subject-matter or the person.

[Ed. Note.—For cases in point, see Cent. Dig. vol. 30, Judgment, § 1476.]

2. SAME.

Under the law of Pennsylvania, which authorizes the entry of a personal judgment without notice on a judgment note, a judgment so entered on a Pennsylvania contract must be accepted by a court in another state as one rendered by a court having jurisdiction.

3. SAME—REVIVAL OF JUDGMENT—JURISDICTION—PENNSYLVANIA STATUTE.

Under Act Pa. April 3, 1903 (P. L. 139), which provides that "two returns of nihil habet shall be equivalent to personal service in writs of scire facias to revive judgments entered in personal actions," and the rule of practice in that state that such writs are a continuation of the original suit, a judgment entered on two such returns in an action in

which the court had original jurisdiction, in ordinary circumstances, is entitled to full faith and credit in another state; but under Act March 26, 1827 (P. L. 129), and Act June 1, 1887 (P. L. 289), which, as construed by the courts of the state, limit the life of a judgment to five years, during which time only it can be revived by scire facias, a judgment of revival, entered on two such writs issued nine years after the original judgment and returned nihil habet, is void for want of jurisdiction, and will not support an action in another state.

At Law. On demurrer to declaration.

T. M. Garvin and S. L. Reed, for plaintiff.

Charles Powell, for defendant.

DAYTON, District Judge. On July 19, 1897, the defendant executed at Pittsburg, Pa., her note to the defendant for \$2,000, and attached to and incorporated in it a power to any attorney of any court of record of Pennsylvania to appear for and to enter judgment against her for that amount, with costs and 5 per cent. collection fees. On December 4, 1897, in the court of common pleas for Allegheny county, Pa., a judgment was confessed by an attorney, acting pro hac vice, against her for the debt, interest, costs, and collection fee, and execution issued, personal property was sold thereunder, and a small portion of the judgment realized thereby. On October 17, 1906, a scire facias to revive this judgment was sued out, and was by the sheriff of Allegheny county, Pa., returned nihil habet. On November 13, 1906, an alias writ of scire facias issued and was likewise returned nihil habet. Thereupon the plaintiff filed his præcipe and affidavit, and judgment was on December 26, 1906, rendered against her for \$2,664.85. On February 28, 1907, the plaintiff instituted in this court his action of debt upon this last judgment, and the defendant has appeared and craved oyer of the record of the judgment from the court of common pleas No. 1 for Allegheny county, Pa.; and, the same having been read to her, she demurred to plaintiff's declaration, the plaintiff has joined therein, argument has been made thereon, and it is this demurrer I have now to determine.

It is insisted in support of the demurrer that the judgment sued upon, being a personal one against the defendant, entered upon writs of scire facias without service, actual or constructive, is void, and this action cannot be maintained upon it, first, because the court of common pleas of Allegheny county, Pa., had no jurisdiction of the person of the defendant such as to empower such court to render personal judgment against her; second, because said judgment is not valid and enforceable in the state of Pennsylvania; third, because, if even enforceable in the state of Pennsylvania, it is not such a judgment as entitles plaintiff to recover, upon the record of it, in this court; fourth, because such judgment is in violation of the fourteenth amendment of the federal Constitution, as not being in conformity with due process of law.

On the other hand, it is insisted by plaintiff, first, that the court of common pleas of Allegheny county, Pa., had full jurisdiction of the person of the defendant by reason of the power incorporated in her note of indebtedness, and that judgment having been rendered original-

ly upon this note whereby jurisdiction was thus conferred, under the rule of the common law, still in force in Pennsylvania, the plaintiff upon two scire facias returned nihil habet was entitled to take this second judgment, based upon the debt embraced in the first; second, that under section 1 of article 4 of the federal Constitution, providing that "full faith and credit shall be given in every state to the public acts, records and judicial proceedings of every other state," this court, now having jurisdiction of the defendant's person, must recognize this judgment as a verity, regardless of any law of this state that might render it otherwise.

In reply to these propositions, and in support of the original grounds of demurrer, plaintiff's counsel insists that under the laws of Pennsylvania the original judgment could remain a lien no longer than five years after the date of its entry without revival by scire facias, that the record discloses that more than five years had elapsed from the date of entry of the original judgment until the issue of the first writ of scire facias to revive, and therefore such original judgment was dead, could not be enforced in Pennsylvania, and cannot be sued on in this state under section 13, c. 104 (section 3506), Code W. Va. 1906, which provides:

"Every action or suit upon a judgment or decree, rendered in any other state or country, shall be barred, if by the laws of such state or country such action or suit would there be barred, and the judgment or decree be incapable of being otherwise enforced there."

The first question that naturally arises is whether this court has, under the constitutional provision referred to, the right to inquire into the question of jurisdiction exercised by the court of another state in rendering a judgment, or whether the assumption of jurisdiction by that court must be held conclusive of such inquiry. For a long time this was a mooted question; but in 1874, in the case of *Thompson v. Whitman*, 18 Wall. 457, 21 L. Ed. 897, Mr. Justice Bradley, collecting previous authorities, held:

(1) "Neither the constitutional provision that full faith and credit shall be given in each state to the public acts, records, and judicial proceedings of every other state, nor the act of Congress passed in pursuance thereof, prevents an inquiry into the jurisdiction of the court by which a judgment of record in evidence was rendered."

(2) "The record of a judgment rendered in another state may be contradicted as to the facts necessary to give the court jurisdiction; and, if it be shown that such facts did not exist, the record will be a nullity, notwithstanding it may recite that they did exist."

(3) "Want of jurisdiction may be shown, either as to the subject-matter or the person, or, in proceedings in rem, as to the thing."

And this doctrine has been since then uniformly upheld in such cases as *Knowles v. Gaslight & Coke Co.*, 19 Wall. 58, 22 L. Ed. 70; *Hill v. Mendenhall*, 21 Wall. 453, 22 L. Ed. 616; *Hall v. Lanning*, 91 U. S. 160, 23 L. Ed. 271; *Pennoyer v. Neff*, 95 U. S. 714-730, 24 L. Ed. 565-571; *Kilbourn v. Thompson*, 103 U. S. 168-198, 26 L. Ed. 377; *Simmons v. Saul*, 138 U. S. 439, 11 Sup. Ct. 369, 34 L. Ed. 1054; *Haddock v. Haddock*, 201 U. S. 562, 26 Sup. Ct. 525, 50 L. Ed. 867.

Having, then, to inquire into the question of jurisdiction of the Pennsylvania court in the premises, it is to be noted: First. That there is nothing in this record to show that the court of common pleas did not have jurisdiction over the person of the defendant at the time the original judgment was rendered; in other words, there is nothing to show that she was at that time a nonresident of that state, or that the contract was executed outside of that state, but, on the contrary, the note, on its face, shows it was executed at Pittsburg, in that state. Second. That while not permitted in this state, it is well-settled law and practice in Pennsylvania for her courts of competent jurisdiction to render personal judgments on contracts of this character by the confession of attorney and without service of notice. I must therefore conclude that this court of common pleas was one of competent jurisdiction, that its jurisdiction under the law as administered in Pennsylvania was properly exercised, and its original judgment was valid and must be recognized as such.

There can be little question that under the common law, in cases arising upon mortgages, the proceeding by scire facias was regarded as a continuation of the original proceeding, and the return of two such writs nihil habet was held to be equivalent to a garnishment and service of the writ, authorizing judgment of revival. Some question has arisen whether this practice in England was designed to apply to other than judgments sur mortgage; but in Pennsylvania, where this common-law practice is still followed, both by decision and statute, the rule has been extended to judgments generally. By Act July 9, 1901 (P. L. 616), of the Pennsylvania Legislature, provision is made for service of process in certain law actions, and then is added:

"Provided that two returns of nihil habet shall be equivalent to personal service, in writs of scire facias to revive judgments entered in personal actions."

This act was amended by the act of the 3d of April, 1903 (P. L. 139), with the same proviso. The original judgment, then, under the laws of Pennsylvania, having been rendered by a court of competent jurisdiction having jurisdiction, and the writ of scire facias, under the law and practice of that state, being held to be only a continuation of the original proceeding in which such judgment was rendered, service of which writ is provided to be satisfied by two returns of nihil habet, under ordinary circumstances, this judgment, upon such writ, would have to be by me held conclusive and entitled to "full faith and credit."

But there is a further complication in this case that renders it exceptional. By the laws of Pennsylvania, if they have been correctly cited to me, the life of a judgment in that state is five years from the date of its rendition; and its life cannot be extended beyond that period by issuance of fieri facias, but only by revival by scire facias within that period. In this particular the law of that state is very greatly at variance with ours, under which "no judgment shall be rendered on a scire facias, or in any other case, on returns of nihil" (Code 1906, § 3812 [chapter 124, § 10]); and suit may be maintained within ten years after the return day of the last execution issued thereon (Code, § 4150

[chapter 139, § 10]). It follows necessarily that I must be governed by the law of the foreign state in this matter :

"The act of March 26, 1827 (P. L. 129), supplied by the act of June 1, 1887 (P. L. 289; P. & L. Dig. col. 2474), provided that no judgment should remain a lien longer than five years without a revival by sci. fa., notwithstanding the issuance of a fi. fa. and levy on real estate, and since these acts the lien cannot be continued merely by the issuance of execution." P. & L. Dig. Pa. vol. 10, col. 16,289.

"Since the act of March 26, 1827 (P. L. 129), supplied by the act of June 1, 1887 (P. L. 289; P. & L. Dig. col. 2474), the judgment must be revived by sci. fa. within five years, notwithstanding a stay of execution." *Id.*, vol. 10, col. 16,292.

The original judgment herein, as shown by the record, was not revived within five years after the date of its entry, and this second judgment was rendered solely upon a scire facias which issued some nine years after, or more than four years after the original judgment was dead and its lien by law extinguished. Nothing appears in the record showing legal excuse or legal disability for this delay. Granting that, if the scire facias had issued within the five years, two returns of nihil habet would have warranted the revival, can this be true where more than five years have elapsed? I cannot think so. It may be contended that the extinguishment of the debt evidenced by the original judgment, and sought by this revival to be carried into the new judgment, by the statutory bar, had to be pleaded by the defendant in order to become effectual, and, not having so pleaded, she is estopped now by the record in this regard. But in reply to this it may well be said that the law did not authorize the suing out of a writ of scire facias to revive a dead judgment; that the plaintiff's remedy in such case could only be by a new and independent action, wherein the defendant should have opportunity, by reason of process duly served upon her, to appear and plead this effective defense arising since the entry of the original judgment. If, upon a judgment dead in law, revivals could be had upon nihil habet returned four years after against them, nonresidents having no notice, they could as well be had in the same way at any time before the ending of time and the coming of eternity, and this particular limitation by statute would be rendered an absurdity.

It follows that I must hold that, under the circumstances of this case, the court of common pleas No. 1 of Allegheny county, Pa., had no jurisdiction to render the second judgment upon the two writs of scire facias, returned nihil habet, here sued upon, and that defendant's demurrer must be sustained.

UNITED STATES v. SCOTT & WEST et al.

(Circuit Court, D. Massachusetts. July 27, 1908.)

No. 312 (1,756).

1. CUSTOMS DUTIES—CLASSIFICATION—PLANK LINOLEUM—"LINOLEUM * * * FIGURED OR PLAIN"—"INLAID LINOLEUM."

Plank linoleum, made by running upon the burlap foundation paste of two colors in stripes of equal width, a process differing from that employed in making inlaid linoleum, is, under Tariff Act July 24, 1897, c.

11, § 1, Schedule J, par. 337, 30 Stat. 180 (U. S. Comp. St. 1901, p. 1662), dutiable as "linoleum * * * figured or plain," rather than as "inlaid linoleum."

2. WORDS AND PHRASES—"PLANK LINOLEUM."

"Plank linoleum" is made by running upon the burlap paste of two colors in stripes of equal width. The paste is prevented by machinery from mixing, and establishes between the stripes a fairly definite line. Pressure follows immediately upon the application of the paste to the burlap. The effect produced somewhat resembles a floor laid in alternate planks of different woods.

On Application for Review of a Decision by the Board of United States General Appraisers.

William H. Garland, Asst. U. S. Atty.

Kammerlohr & Duffy (Joseph G. Kammerlohr, of counsel), for importers.

LOWELL, Circuit Judge. This was an appeal by the United States from a decision of the Board of General Appraisers, G. A. 6633 (T. D. 28,291), holding the importation to be dutiable under the first clause of paragraph 337 of the Dingley act (Act July 24, 1897, c. 11, § 1, Schedule J, 30 Stat. 180 [U. S. Comp. St. 1901, p. 1662]). That paragraph reads as follows:

"Oilcloth for floors, stamped, painted, or printed, including linoleum or corticene, figured or plain, and all other oilcloth (except silk oilcloth) under twelve feet in width not specially provided for herein, eight cents per square yard and fifteen per centum ad valorem; oilcloth for floors and linoleum or corticene, twelve feet and over in width; inlaid linoleum or corticene, and cork carpets, twenty cents per square yard and twenty per centum ad valorem; waterproof cloth, composed of cotton or other vegetable fiber, whether composed in part of india-rubber or otherwise, ten cents per square yard and twenty per centum ad valorem."

For earlier acts, see 22 Stat. 507; 26 Stat. 593; 28 Stat. 529.

The United States contends that the linoleum in question was "inlaid" within the meaning of the paragraph. The Board of General Appraisers reversed the decision of the collector, who held that the importation was dutiable as inlaid linoleum.

From the evidence it appears that, at the time of the passage of the Dingley act, three kinds of linoleum were commonly known in the trade:

(1) Plain linoleum, made by pressing a paste of uniform color upon the burlap which constitutes the back of all linoleum.

(2) Printed linoleum, upon which the desired pattern was printed.

(3) Inlaid linoleum, in which the pattern was produced by laying upon the burlap differently colored pastes according to the pattern desired, the same being forced into the burlap by pressure, as above stated. These differently colored pastes were laid upon the burlap in one of two ways: (a) By cutting out the figure from the previously applied background, and filling the holes thus made with the desired color; or (b) by applying the several colors to the burlap with a stencil.

Since the passage of the act at least two other sorts of linoleum have become common in the trade, viz.:

(4) "Granite linoleum," in which the paste contains masses or spots of different colors, which colors remain separate in the completed fabric. The assemblage and relation of these variously colored spots and masses is, however, casual. Granite linoleum must have been known in 1897, but seems not to have been common at that time. It has been held to be subject to the lower rate of duty by the decision of the Circuit Court of Appeals in *United States v. Hunter & Whitcomb*, 127 Fed. 1022, 61 C. C. A. 270, affirming (C. C.) 121 Fed. 207.

(5) The goods here in question, which are known as "plank linoleum," "oak plank linoleum," and, according to the testimony of some of the government's witnesses, "plank inlaid linoleum." The material is made by running upon the burlap paste of two colors in stripes of equal width. A machine, unknown to the art before 1897, prevents the pastes from mixing, and establishes between the stripes a fairly definite line. Pressure follows immediately upon the application of the paste to the burlap. The fact that each of the two sorts of paste employed is not altogether uniform in color, but is somewhat mottled, is immaterial in the case at bar. The effect produced somewhat resembles a floor laid in alternate planks of different woods.

The manufacture of the goods in question is not that used in making plain, printed, or inlaid linoleum at the time of the passage of the Dingley act, nor is it that used in the making of granite linoleum either before or afterwards. The United States has not shown that the importation is "inlaid linoleum" with respect to its method of manufacture.

The United States has sought to show a commercial designation of the importation as "inlaid plank linoleum." Three witnesses have testified to this effect. One of them is a domestic manufacturer, somewhat interested in the issue of this case. Another described the article as "plank linoleum" before the beginning of this controversy, but has since styled, not only the goods in question, but even granite linoleum, as "inlaid." Most of the importers' witnesses are themselves importers or otherwise interested more or less in the controversy. Upon the whole, however, their evidence appears to me more weighty, and I do not think the government has made out a commercial designation of the importation as "inlaid linoleum" or "inlaid plank linoleum."

It is to be observed, furthermore, that the cost of the goods in question is little, if at all, greater than that of granite linoleum, and is considerably less than that of linoleum admitted to be inlaid. Until recently the goods in question have been assessed for duty at the lower rate, so that the decision of the Board of General Appraisers must be taken as upholding the departmental practice, rather than reversing it. It is true that most of the testimony now before the court has been taken since the decision of the Board of General Appraisers; but, on the whole, the government appears to me to have failed to show that the importation is inlaid linoleum. That it is dutiable under some part of paragraph 337 I cannot doubt, and I therefore hold that the Board of General Appraisers was right.

Ex parte RONCHI.

(District Court, S. D. New York. September 5, 1908.)

EXTRADITION—INTERNATIONAL—GROUNDS—EMBEZZLEMENT AS PUBLIC OFFICER.

To warrant the extradition of a person to Italy under section 7, art. 2, of the treaty of March 23, 1868, with that country (15 Stat. 630), which provides for the extradition of persons charged with "the embezzlement of public moneys committed within the jurisdiction of either party by public officers or depositors," where the accused was charged with having as treasurer of a hospital embezzled its funds, the proof must show that the hospital was a public institution, that the accused, as its treasurer, was a public officer or depositor, and that the money taken was public money.

[Ed. Note.—Scope of review on habeas corpus to procure release of person sought to be extradited, see note to *Bruce v. Rayner*, 62 C. C. A. 506.]

Habeas Corpus and Certiorari.

Pratt, Koehler & Russell (Addison S. Pratt, of counsel), for prisoner.

Gino C. Speranza, for the Italian government.

HOLT, District Judge. These are writs of habeas corpus and certiorari to test the validity of the detention of Arturo Ronchi by the United States marshal under a warrant of commitment issued by a United States commissioner in extradition proceedings. The warrant was issued upon the complaint of the Italian vice consul at New York, which charged that Ronchi had been guilty of forgery and embezzlement in Italy. A hearing has been had before the commissioner, who has rendered a decision dismissing the charge of forgery, but holding that the prisoner should be extradited under the charge of embezzlement. The question upon this proceeding is whether the evidence before the commissioner was sufficient to sustain a charge of the kind of embezzlement which is made an extraditable offense by the treaty between Italy and this country.

Article 2 of the Italian treaty of March 23, 1868, as amended January 21, 1869, provides for the extradition of persons charged with:

"7. The embezzlement of public moneys committed within the jurisdiction of either party by public officers or depositors." 15 Stat. 630.

"8. Embezzlement by any person or persons hired or salaried, to the detriment of their employers, when these crimes are subject to infamous punishment according to the laws of the United States, and criminal punishment according to the laws of Italy." 16 Stat. 767.

These provisions provide for the extradition of two classes of embezzlers: Embezzlement of public money by public officers, and embezzlement by any person hired or salaried—that is, by clerks, employes, servants, etc. The embezzlement of private money by private persons not hired or salaried, as, for instance, by trustees, bailees, agents, etc., is not covered by the treaty. Embezzlement itself is not a common-law crime, but is purely a statutory offense; and in any ordinary prosecution for embezzlement a case must be charged and proved precisely within the statute. So in extradition treaties it

is common to provide for extradition only in certain kinds of embezzlement, and in such a case the charge must allege, and the proof must affirmatively establish, that the prisoner has committed one of the kinds of embezzlement which makes him the subject of extradition under the treaty. The complaint of the consul, on which the warrant was issued, charges:

"That Arturo Ronchi, at or near Naples in the Kingdom of Italy, heretofore and on or about the 17th day of January, 1908, committed the crime of embezzlement, in having, at said time and place, as a public officer and as treasurer of the Philanthropic Institution Ravaschieri, a public institution, unlawfully appropriated to his own use large sums of money from said institution."

This is the sole charge of embezzlement contained in the complaint, and in my opinion this is a charge of an offense under section 7 of article 2 of the treaty relating to the embezzlement of public moneys by public officers, and not under section 8. The proof shows that Ronchi was the clerk and treasurer of the Hospital Ravaschieri, a hospital for cripples at Naples, founded by the Countess Ravaschieri; that he obtained the sum of 12,000 lire, the property of the hospital, by presenting a certificate of credit, upon which some of the signatures were forged; and that he confessed to the officers who arrested him that he had loaned from the hospital funds from 10,000 to 20,000 lire to personal friends, and, when he found that they could not repay the sums loaned, he had taken more of the hospital funds, amounting in all to about 80,000 lire, and had come to this country. There is no proof in the case that the Hospital Ravaschieri was a public institution, that its moneys were public moneys, or that Ronchi, in his capacity as clerk or treasurer, was a public officer or depositor. So far as the proof shows, this hospital, like many others, may be an exclusively private institution, maintained by private moneys, the officers of which are private persons. I think, therefore, that the proof in this case is fatally defective.

As the offense proved, however, is a serious one, which ought, so far as is shown by the evidence before me, to be criminally punished if the law permits it, I think that, if the representatives of the Italian government request it, the prisoner should be held under remand, in order to permit the necessary proof to be obtained. If, in fact, the Hospital Ravaschieri is a public institution, and its funds public moneys, and its officers public officers, or if it is a private institution, and Ronchi was a hired or salaried officer of it, he can be extradited, if such facts are properly charged and proved. But if it is a private institution, and Ronchi served it as an officer without pay, I do not think his case comes within the provisions of the treaty.

The prisoner is remanded until September 14th, with leave to the representatives of the Italian government to apply to the commissioner for further time, if they determine to take further proceedings and more time shall then appear to be necessary.

MEMPHIS COTTON OIL CO. et al. v. ILLINOIS CENT. R. CO. et al.

(Circuit Court, W. D. Tennessee, W. D. September 29, 1908.)

No. 644.

COURTS—FEDERAL COURTS—DISTRICT OF SUIT.

Under section 1 of the federal judiciary act (Act March 3, 1875, c. 137, 18 Stat. 470), as amended by Act March 3, 1887, c. 373, 24 Stat. 552, and Act Aug. 13, 1888, c. 866, 25 Stat. 433 (U. S. Comp. St. 1901, p. 508), a suit against a railroad company based on the interstate commerce act, and within the jurisdiction of a federal court for that reason, can only be brought in the state in which the defendant is incorporated.

[Ed. Note.—For cases in point, see Cent. Dig. vol. 13, Courts, § 814.

Jurisdiction of federal courts over corporations, see note to St. Louis, I. M. & S. Ry. Co. v. Newcom, 6 C. C. A. 174.]

In Equity. On plea to jurisdiction.

Percy & Hughes, for complainants.

C. N. Burch, for defendant Illinois Cent. R. Co.

J. P. Houston, for defendant Louisville & N. R. Co.

McCALL, District Judge. This is an action brought on the equity side of this court by the complainants to restrain the defendant railroad companies from putting into effect on October 1, 1908, an increased freight rate on certain products that are manufactured in Memphis and shipped in interstate commerce. We are met at the threshold with a plea to the jurisdiction of the court over the defendants.

The bill on its face, as originally presented, carried as plaintiffs citizens of Tennessee, and, in addition, an individual citizen of Georgia, and a corporation, a citizen and resident of the state of New Jersey. The plea in abatement to the jurisdiction was prepared to meet both phases of the bill; that is, in so far as the jurisdiction was based upon the diverse citizenship of the parties, it could not be maintained, because all of the complainants were not citizens of Tennessee; also, that it could not be maintained as an original bill against the defendants, for the reason that both of the defendants are nonresidents of Tennessee, one being a corporation and inhabitant of the state of Kentucky, and the other a corporation and inhabitant of the state of Illinois, and they were entitled to be sued, if sued at all, in the district of which they are inhabitants.

The first proposition was eliminated by counsel for complainants dismissing the bill without prejudice as to all the nonresident complainants. So that the case is left in the simple shape of citizens of Tennessee filing an original bill in the United States court of Tennessee against citizens of the states of Illinois and Kentucky. The question is presented whether or not these defendants can be sued in this action in this court, they being citizens of other states? The act determining the jurisdiction of the Circuit Courts of the United States provides:

“That the Circuit Courts of the United States shall have original cognizance, concurrent with the courts of the several states, of all suits of a civil nature, at

common law or in equity, where the matter in dispute exceeds, exclusive of interest and costs, the sum or value of two thousand dollars, and arising under the Constitution or laws of the United States, or treaties made or which shall be made under their authority, or in which controversy the United States are plaintiffs or petitioners, or in which there shall be a controversy between citizens of different states, in which the matter in dispute exceeds, exclusive of interest and costs, the sum or value aforesaid, or a controversy between citizens of the same state claiming lands under grants of different states, or a controversy between citizens of a state and foreign states, citizens, or subjects in which the matter in dispute exceeds, exclusive of interest and costs, the sum or value aforesaid, and shall have exclusive cognizance of all crimes and offenses cognizable under the authority of the United States, except as otherwise provided by law, and concurrent jurisdiction with the District Courts of the crimes and offenses cognizable by them." Act March 3, 1875, c. 137, § 1, 18 Stat. 470, as amended by Act March 3, 1887, c. 373, 24 Stat. 552, and Act Aug. 13, 1888, c. 866, 25 Stat. 433 (U. S. Comp. St. 1901, p. 508).

In the case before us the important part of the judiciary act is the following clause:

"But no person shall be arrested in one district for trial in another in any civil action before a Circuit or District Court; and no civil suit shall be brought before either of said courts against any person by any original process or proceeding in any other district than that whereof he is an inhabitant, but where the jurisdiction is founded only on the fact that the action is between citizens of different states, suit shall be brought only in the district of the residence of either the plaintiff or the defendant."

It is clear from the last paragraph that no suit shall be brought in either of the United States courts against any person by any original process in any other district than that whereof he is an inhabitant except where the jurisdiction is founded only on the fact that the action is between citizens of different states.

In *Van Patten v. Chicago, M. & St. P. R. Co.* (C. C.) 74 Fed. 981, it is held that the judiciary act of 1888 does not apply to cases brought under the laws as they existed prior to that act, wherein the United States courts have exclusive jurisdiction. That case seems to be on all fours with the case at bar, and I felt inclined to follow it, but in the case of *In re Keasby & Mattison Company*, 160 U. S. 221, 16 Sup. Ct. 273, 40 L. Ed. 402, the Supreme Court of the United States seems to have held differently, and I think the latter case must control here. There is this difference between the *Van Patten* and *Keasby* Cases: In the former the United States courts had exclusive jurisdiction of the subject-matter, while in the latter the United States courts and the state courts have concurrent jurisdiction.

No contention is made that the federal and state courts have concurrent jurisdiction of the case under consideration. If this point is material, as Judge Shiras held in the *Van Patten* Case, it seems to have been overlooked by the Supreme Court of the United States in the *Keasby* Case, as it appears in the quotation from that case which follows. That was a suit in relation to a trade-mark, and the Circuit Court of the United States for the state of New York declined to take jurisdiction of the case, and proceedings were had to compel them to do so, and Judge Gray said:

"But when this suit was brought the first section of the judiciary act of 1875 had been amended by Act March 3, 1887, c. 373, as corrected by Act Aug. 13, 1888, c. 866, in the parts above quoted, by substituting for the juris-

dictional amount of \$500, exclusive of costs, the amount of \$2,000, exclusive of interest and costs, and by striking out after the clause, 'and no civil suit shall be brought before either of said courts against any person, by any original process or proceeding in any other district than that whereof he is an inhabitant,' the alternative, 'or in which he shall be found at the time of serving such process, or commencing such proceeding,' and adding, 'but where the jurisdiction is founded only on the fact that the action is between citizens of different states, suit shall be brought only in the district of the residence of either the plaintiff or the defendant.' The last clause is added by way of a proviso to the next preceding clause, which, in its present form, forbids any suit to be brought in any other district than that of which the defendant is an inhabitant, and the effect is that in every suit between citizens of the United States, when the jurisdiction is founded upon any of the grounds mentioned in this section other than the citizenship of the parties, it must be brought in the district of which the defendant is an inhabitant; but when the jurisdiction is founded only on the fact that the parties are citizens of different states, the suit shall be brought in the district of which either party is an inhabitant. And it is established by the decisions of this court that, within the meaning of this act, a corporation cannot be considered a citizen, an inhabitant or resident of a state in which it has not been incorporated, and consequently that a corporation incorporated in a state of the Union cannot be compelled to answer to a civil suit, at law or in equity, in a Circuit Court of the United States held in another state, even if the corporation has a usual place of business in that state, *McCormick Co. v. Walthers*, 134 U. S. 41, 43, 10 Sup. Ct. 485, 33 L. Ed. 833; *Shaw v. Quincy Mining Co.*, 145 U. S. 444, 12 Sup. Ct. 935, 36 L. Ed. 768; *Southern Pacific Co. v. Denton*, 146 U. S. 202, 13 Sup. Ct. 44, 36 L. Ed. 942. Those cases, it is true, were of the class in which the jurisdiction is founded only upon the fact that the parties are citizens or corporations of different states. But the reasoning on which they proceeded is equally applicable to the other class, mentioned in the same section, of suits arising under the Constitution, laws, or treaties of the United States; and the only difference is that, by the very terms of the statute, a suit of this class is to be brought in the district of which the defendant is an inhabitant, and cannot, without the consent of the defendant, be brought in any other district, even in one of which the plaintiff is an inhabitant."

In the case at bar the complainants are inhabitants of Tennessee. The defendants are citizens and inhabitants of other states. The suit is one arising under the laws of the United States, viz., Interstate Commerce Act Feb. 4, 1887, c. 104, 24 Stat. 379 (U. S. Comp. St. 1901, p. 3154), as subsequently amended. I am constrained to hold that the plea to the jurisdiction of the court is sufficient, and should be sustained. In the case of *Sunderland Bros. v. Chicago, R. I. & P. Ry. Co.* (C. C.) 158 Fed. 877, the same conclusion was reached, and the case is very similar to this one.

An order will be entered in conformity with the views herein expressed.

In re HARRIS.

(District Court, S. D. New York. August 28, 1908.)

BANKRUPTCY—DELIVERY OF BOOKS TO TRUSTEE—CLAIM OF PRIVILEGE.

A bankrupt is not permitted to withhold his books from his trustee or receiver on his mere assertion that they contain evidence which would tend to incriminate him; but he must produce them, that the question may be determined by the court or referee, and that, if it appears that they do contain such evidence, the court may make such order as will protect the bankrupt from its use in any criminal case, and at the same time give the trustee the use of the books in the administration of the estate.

In Bankruptcy. On motion to require bankrupt to deliver his books to the receiver.

James, Schell & Elkus (Abram I. Elkus and Robert P. Levis, of counsel), for receiver.

Fischer & Rosenbaum (Louis J. Vorhaus and Joseph Fischer, of counsel), for alleged bankrupt.

HOLT, District Judge. This is a motion that the bankrupt deliver his books of account to the receiver. The bankrupt declines to do so on the ground that the books contain entries which would incriminate him. It appears from the moving papers that the bankrupt made a statement to a mercantile agency, that his books contain entries which show that the statement to the agency was incorrect, and that some of the bankrupt's creditors have threatened to prosecute him criminally.

The question involved in this motion is important. On the one hand, the law is well settled that the constitutional provision that no man shall be compelled to be a witness against himself enables a person, under ordinary circumstances, to refuse, not only to give oral testimony, but to produce his books and papers, on the ground that they would tend to incriminate him (*Boyd v. U. S.*, 116 U. S. 616, 6 Sup. Ct. 524, 29 L. Ed. 746), and it has been held that a bankrupt, as well as any other person, is entitled to the protection of such constitutional provision (*In re Kanter & Cohen* [D. C.] 9 Am. Bankr. Rep. 104, 117 Fed. 356). In *Boyd v. U. S.*, the defendant's books were subpoenaed to be used against him on a trial in an action brought by the government to recover penalties for smuggling. In the *Kanter & Cohen* Case the bankrupts had been actually indicted, and it was the obvious purpose of the proceedings for the production of the books to obtain proof of the defendants' guilt on the trial of the indictment. But in the case at bar no criminal prosecution has been brought, and the only purpose for which the receiver wants the books is to administer the estate.

A rule under which a bankrupt may, in any case, at his own option; refuse to produce his books, may in many instances almost paralyze the power of the court to administer the estate. No business of any considerable magnitude can be or is carried on without keeping books of account; and when such a business becomes bankrupt it is practically almost impossible for a receiver or trustee to properly discharge his duties without having possession of the books of the business. In view of this necessity in bankruptcy cases, it has been held that a bankrupt is not permitted to withhold his books from his trustee on his mere assertion that they tend to incriminate him, but must produce them before the court or referee in bankruptcy, in order to have the question determined whether they do, in fact, tend to incriminate him, and that, if it appears that they do contain incriminating evidence, the court can make such an order as will protect the bankrupt from the use of such evidence for any criminal proceeding, and at the same time will enable the trustee to make such use of the books as may be necessary to administer the estate. *In re Hess* (D. C.) 14 Am. Bankr.

Rep. 559, 134 Fed. 109; In re Hark Bros. (D. C.) 14 Am. Bankr. Rep. 624, 136 Fed. 986.

While the practical difficulty of absolutely protecting a bankrupt in such a case must be admitted, the necessity, on the other hand, of giving the officer who administers a bankrupt estate access to the books is so imperative that, in my opinion, the practice suggested in the cases cited should be followed. The bankrupt's counsel, in whose possession the books are, asserts that he has heretofore permitted the receiver to examine the books, and that he is willing that he shall continue to do so, provided he is assured that no use will be made of any information contained in them in aid of any criminal prosecution. I do not see any essential difference between an arrangement by which the receiver is permitted to consult the books in the possession of the bankrupt's attorneys, and one by which the receiver shall be permitted to take the books into his own possession, provided that proper guarantees are made against the use of the books in aid of a criminal prosecution.

An order may be entered directing that the attorney for the bankrupt deliver the books to the receiver, who is to receive them as the agent of the bankrupt, and is to use them or permit their use by any other person only for the purpose of the civil administration of the estate in bankruptcy. The order may contain a provision that, in case any subpoena or other process is issued for the purpose of obtaining possession of the books in the receiver's custody, it shall be the duty of the receiver to notify the bankrupt, and not to part with the books until the bankrupt has had an opportunity to raise the question of his constitutional privilege in the same manner as though his books had remained in his own possession.

The order should be settled on notice, and if any additional provisions for the protection of the bankrupt are desired they may be suggested when the order is submitted.

WATSON, PRESTON & CO. v. GREENWOOD & CO.

(Circuit Court, E. D. Pennsylvania. October 8, 1908.)

No. 42.

SALES—REMEDIES OF SELLER—ACTION FOR BREACH OF CONTRACT—NECESSITY OF TENDER OF PERFORMANCE.

Plaintiffs contracted to sell to defendants certain stocks and bonds, to be delivered at the office of a trust company in Chicago on a date named. Prior to the date named the securities were assembled in a bank 300 miles from Chicago, and were to be forwarded by the bank to the trust company on notice from plaintiffs by telegraph or telephone. Three days before the date for delivery plaintiffs were notified by an agent of defendants that the latter would be unable to receive and pay for the securities on that date. *Held*, that under such circumstances, and on a finding by the jury that plaintiffs were ready and able to make delivery, they were not required to have the securities brought to Chicago for the purpose of making a tender, in order to entitle them to maintain an action for breach of the contract.

[Ed. Note.—For cases in point, see Cent. Dig. vol. 43, Sales, § 1087.]

At Law. Sur motion for new trial and for judgment non obstante veredicto.

E. J. Pershing and George E. Nichols, for plaintiff.
George Wharton Pepper, for defendant Maury.
Joseph De F. Junkin, for defendant Greenwood.

HOLLAND, District Judge. The plaintiffs, Chicago bankers, sued the defendants, as partners, in Philadelphia, for damages for breach of contract made by the defendants to purchase from the plaintiffs certain stocks and bonds of a gas and electric light company in Illinois. The contract was in writing, dated July 7, 1906, the important clause of which is the following:

"On or before the 1st of August, 1906, the party of the second part [defendants] hereby agrees to pay to the party of the first part the sum of two hundred and thirty-five thousand dollars (\$235,000) in cash, place of deposit to be the American Trust & Savings Bank, of Chicago, Ill., where all securities are to be assembled and all clearances made in accordance with the terms of this contract."

It appeared at the trial that the owner of the stocks and bonds in question, in the spring of 1906, had entered into an agreement to sell the same to two men, named Horner and Daab, residents of Chicago, for \$198,000, and the latter in turn made an agreement of sale for these securities with the plaintiffs to deliver them at the American Trust Company, of Chicago, on the 1st day of August for delivery to the defendants. No money, however, had passed, and the price that the plaintiffs were to pay Horner and Daab was \$205,000. These securities were assembled at the bank in Belleville, Ill., some 300 miles distant from Chicago, and about seven hours by train. The securities were ready for delivery at any time, and arrangements had been made with the cashier of the Belleville bank to have the securities at Chicago upon a notice by telephone or telegraph from the plaintiffs. The evidence shows that the securities were assembled in the Belleville bank prior to August, 1906, and ready to be delivered to the American Trust Company, of Chicago, on that date, and the uncontradicted evidence of Watson shows that they were ready and willing to deliver them, in accordance with the contract, on the 1st day of August, and telegraphed the defendants to that effect, which telegram was received by the latter about 12 o'clock on that day; and the evidence of Watson further shows they were willing to deliver, and it tends to establish that they would have been able to have produced the securities at the place appointed in Chicago, after sending the telegram, if the defendants had desired their delivery.

We do not think in this case that the plaintiffs were required to do more than they had done, in view of the fact that on the 28th day of July, before the date of delivery, a Mr. Schott, who was in New York, and who had authority to represent the defendants, wrote the plaintiffs:

"That the syndicate [meaning the defendants] would be unable to pay more than \$25,000 in cash and to give notes for 60 or 90 days for the balance, secured by the property purchased, deposited in trust."

The receipt of this information was sufficient to indicate that the defendants would not perform in accordance with the contract, and it excuses the plaintiffs from producing the bonds and stocks at the American Trust Company for the purpose of tendering to a party whom they knew would not be there to receive the tender in accordance with their agreement. The law does not require that to be done which manifestly would be a vain and idle ceremony. Hunt on Tender, § 236.

The question was submitted to the jury as to whether the plaintiffs were ready and able to perform, and they found that they were, and there was ample evidence to sustain such finding; but the defendants, after having failed in a negotiation to have the time extended, two days before notified the plaintiffs that they would be unable to perform, it would be inequitable to require the plaintiffs to incur additional trouble and expense, when they had been previously informed that the defendants could not perform their part of the contract. A similar situation was considered by the Supreme Court in the case of *Hinckley v. Pittsburg Bessemer Steel Co.*, 121 U. S. 264, 7 Sup. Ct. 875, 30 L. Ed. 967, where the defendant agreed in writing to purchase for the plaintiff steel rails, to be rolled by the latter, "and to be drilled as may be directed." The defendant failed to give directions as to the drilling when requested, and notified the plaintiff they were unable to receive the delivery of the rails, and requested a delay in the making of them. The defendant did not manufacture any of the rails, but after the time had expired for delivery the plaintiff refused to accept them, and the defendant brought suit for damages. The Supreme Court held that the plaintiff was not bound to roll the rails and tender them to the defendant.

There are a number of reasons for a new trial, none of which, however, need be considered, as we do not think they were very seriously urged at the argument. The motion for judgment non obstante veredicto was urged upon the ground that the plaintiffs had not made a sufficient tender under the law. The whole question, we think, was properly submitted to the jury under the charge, and for the reasons stated the motions, both for a new trial and for judgment non obstante veredicto, are overruled, and judgment entered on the verdict.

LUCKENBACH v. McDONALD.

SAME v. KUNZIG.

(Circuit Court, E. D. Pennsylvania. October 9, 1908.)

Nos. 62, 63.

1. BILLS AND NOTES — LIABILITY OF INDORSER — PRESENTMENT AND NOTICE OF NONPAYMENT.

Defendants were respectively president and secretary of a corporation, and also directors and large stockholders. The corporation had no assets whatever from which it could realize money, but was engaged in the execution of two contracts which defendants regarded as valuable. For the purpose of continuing with performance of the contracts they borrow-

ed money from plaintiff's testator, giving a note, which they signed on behalf of the corporation, and also, with another director, indorsed individually. When the note matured the company had no money with which to pay it, as defendants as its executive officers knew. *Held*, that under Negotiable Instrument Act Pa. May 16, 1901 (P. L. 206) § 80, which provides that "presentment for payment is not required in order to charge an indorser where the instrument was made or accepted for his accommodation and he had no reason to expect that the instrument will be paid if presented," and section 115 (P. L. 209), which provides that "notice of dishonor is not required to be given to an indorser * * * (3) where the instrument was made or accepted for his accommodation," the holder of the note was not required to present it to defendants for payment by the company, nor to give them an unnecessary notice of its dishonor, in order to hold them as indorsers.

2. ALTERATION OF INSTRUMENTS—EFFECT.

An alteration made in a note after it was signed by an indorser, but before its delivery, by or with the consent of the agent of such indorser, authorized to act for him in the transaction, does not release him from liability.

At Law. On motion for judgment non obstante veredicto and for a new trial.

Charles Biddle, for plaintiff.

Thomas McConnell, Jr., J. Henry Williams, and John G. Johnson, for defendants.

HOLLAND, District Judge. This suit is brought by the executor of the payee of a note for \$10,000, dated July 2, 1903, payable four months after date, to the order of the testator, at Philadelphia, with interest, against the defendants as indorsers. The note is as follows: "\$10,000. Philadelphia, Pa., July 2, 1903.

"Four months after date I promise to order to the order of Lewis Luckenbach ten thousand dollars, at 1336 Beach St., Philadelphia, without defalcation, for value received.

Holden Regealed Ice & Machine Co.,

"Henry J. Kunzig, Prest.

"Frank J. McDonald, Secy."

Said note was indorsed as follows:

"Henry J. Kunzig.

"Frank J. McDonald.

"Sommers J. Smith."

At the trial of the case the uncontradictory evidence disclosed the facts that the ice machine company had no assets whatever with which to meet its indebtedness, and that it was engaged at the time in the execution of two contracts which were considered valuable. The board of directors consisted of Henry J. Kunzig, Frank J. McDonald, Sommers J. Smith, and Franklin S. Horn. All these men were large stockholders, very much interested in the completion of the contract. They found it necessary to borrow money to continue the work, and Lewis A. Luckenbach was appealed to for aid. He loaned them \$10,000, taking the company's note, with the understanding that Kunzig, McDonald, and Smith should indorse the same, which they did. The note was executed without authority of the board of directors, and signed by Kunzig as president and McDonald as secretary. McDonald never met Luckenbach, but was represented by Kunzig, who transact-

ed the matter and secured the loan, went to New York, received the check and the note from Mr. Luckenbach, brought them to Philadelphia, where the note was executed by Kunzig as president and McDonald as secretary, and indorsed by Kunzig, McDonald, and Smith, in accordance with the arrangement made by Kunzig. Kunzig, McDonald, and Smith were the three active directors and conducted the business of the company. The company had no other assets whatever, excepting the patents, upon which they could not realize, and the consideration for the contracts which were being executed by Kunzig, McDonald, and Smith with the money borrowed from Luckenbach. When the note came due the indorsers were aware of the fact that there were no funds to pay the note, as they were the parties who were superintending the work of the company. It was not presented for payment, nor was there formal notice given either to Kunzig, McDonald, or Smith of its dishonor. The plaintiff claimed at the trial of the case that he was not required to present the same for payment, nor give notice to the indorsers, to enable him to recover.

The court directed the jury to render a verdict in favor of the plaintiff, first, because the note was made for the benefit of the indorsers; and, secondly, they were officers of the particular institution that was to pay it when it came due, and to whom it had to be presented for payment, and who knew all about it. They knew there were no funds to pay it, and had all the knowledge that could have been given to them by a protest in the regular way. The court having refused to direct a verdict in favor of the defendants, in accordance with their motion, all the evidence taken at the trial was duly certified and filed as part of the record, and the defendants in due time moved the court for judgment non obstante veredicto.

At the argument on this motion it was urged that under the negotiable instrument act of Pennsylvania of May 16, 1901 (P. L. 206), the defendants could only be held as indorsers under section 63 of the act, which provides:

"A person placing his signature upon the instrument other than as maker, drawer or acceptor, is deemed to be an indorser, unless he clearly indicates by appropriate words his intention to be found in some other capacity."

If there was no other evidence in the case except the note itself, with these defendants appearing as they do upon the back of the note as indorsers, of course, this section would apply, and they could not be held in any other capacity. It would then have been necessary for the plaintiff to prove presentment and notice. But this section has no application, because the uncontradicted evidence, aside from the note, shows that the case falls within sections 80 and 115 of the negotiable instrument act. It is provided in section 80 that:

"Presentment for payment is not required in order to charge an indorser where the instrument was made or accepted for his accommodation, and he had no reason to expect that the instrument will be paid if presented."

And section 115 provides that:

"Notice of dishonor is not required to be given to an indorser in either the following cases: * * * (2) Where the indorser is the person to whom the

instrument is presented for payment; (3) where the instrument was made or accepted for his accommodation."

The evidence shows that the indorsers were the real parties in the transaction, and the name of the ice company was only used for the purpose of carrying out the transaction between the indorsers and the lender. The plaintiff, if he had endeavored to present the note at maturity, would necessarily have presented it to either Kunzig or McDonald. These men knew there were no other parties who could pay the note but themselves in any capacity, and they had all the information which they could have received if every formality required by the law had been complied with. For these reasons the motion for judgment non obstante veredicto is overruled.

There are also motions and reasons for a new trial in both cases, and as to Kunzig the reasons are (1) that the court erred in refusing to affirm the point submitted by the defendant, viz., that under all the evidence the verdict must be for the defendant; (2) that the court erred in directing a verdict for plaintiff. The same reasons are filed in the motion for a new trial in the case against McDonald, and as to the latter an additional reason is urged that the court erred in refusing to permit the defendant (McDonald) to file an affidavit of defense nunc pro tunc, stating that the note sued upon had been altered by the addition of the words "with interest" after its execution and delivery, and that it was indorsed and delivered by him without his knowledge or consent, and that this fact became known to him only at the trial of the cause. The fact was disclosed when the first witness was called, and this motion to amend was not made until the close of the trial of the case.

The evidence showed that Kunzig represented himself, McDonald, and Smith in negotiating the loan from Luckenbach. Kunzig went to New York for the money, received the check and the note, brought it to Philadelphia, placed the check in the treasury of the company, and returned personally with the note after it had been indorsed by himself, McDonald, and Smith. He was their representative, and was authorized to return the security which he agreed with Luckenbach should be executed in his favor to guarantee the loan. It was put in his possession for that purpose, and he represented the other defendants in the alteration as much as he represented himself. *Robertson v. Hay*, 91 Pa. 242. So that, as the amendment could not have changed the result if allowed, the defendant was not hurt by the ruling of the court.

The motion for a new trial is therefore overruled, and the other reasons for a new trial in both cases are overruled, for the reasons given on the motion for judgment non obstante veredicto.

In re J. C. H. CLAUSSEN & CO.

GREER v. SIMMONS.

(District Court, D. South Carolina. July 16, 1908.)

1. BANKRUPTCY—UNRECORDED MORTGAGE—SOUTH CAROLINA STATUTE.

Under Civ. Code S. C. 1902, § 2456, which provides that mortgages of any property shall not be valid as against subsequent creditors of the mortgagor unless recorded within 40 days, a mortgagee of a bankrupt whose mortgage was not so recorded has no right in the proceeds of the mortgaged property unless or until the claims of subsequent creditors have been paid in full.

2. SAME—ALLOWANCE OF ATTORNEY FEES—SERVICES RENDERED FOR MORTGAGEE.

The attorney for a mortgagee of a bankrupt who was permitted to sell the mortgaged property and hold the proceeds subject to the orders of the bankruptcy court, and is subsequently adjudged to have no interest therein, is not entitled to an allowance from the fund for services rendered, except in so far as such services contributed to create or conserve such fund for the benefit of the estate.

In Bankruptcy. On exceptions to report of referee.

Buist & Buist, for trustee and bankrupt.

Mordecai & Gadsden and Rutledge & Hagood, for Simmons.

BRAWLEY, District Judge. This case is before me on exceptions to the report of the referee, filed in behalf of B. I. Simmons, the mortgagee.

I had occasion to examine the question upon a state of facts substantially identical, and filed an opinion reported in *Re Cannon* (D. C.) 121 Fed. 582, which, until reversed or modified, controls the case. I have been asked to review that case, but no new arguments have been presented and no authorities submitted. As I gave the question careful consideration at that time, I see no reason to change the views then expressed. It is therefore ordered and adjudged that the report of the referee be, and it hereby is, affirmed.

Another question is presented by the exceptions of the trustee to the allowance of a fee of \$250 to T. M. Mordecai, attorney for B. I. Simmons. It appears that Mr. Mordecai was retained by Mr. Simmons at the time when he was proceeding to foreclose his mortgage. Upon proceedings duly had, Mr. Simmons was allowed to sell the property covered by his mortgage, and hold the proceeds of the same subject to the order of this court. For any service rendered by Mr. Mordecai in conserving the fund, he would be entitled to be paid out of the fund a reasonable compensation. From the testimony before me I cannot see wherein he has rendered such service in the conservation of the fund as would entitle him to a fee of \$250. As between himself and Mr. Simmons, it may well be that a fee of \$250 was proper, but services rendered exclusively for the benefit of Mr. Simmons cannot be paid out of the fund upon which he has, as mortgagee, no claim. Upon the hearing before me Mr. Mordecai stated that there was a distress warrant for rent which he successfully resisted. That was a service in preserving the fund for which he would

be entitled to compensation, but I am unable to form any estimate of the value of such service or the amount that should be allowed. The case, therefore, must go back to the referee, with directions to inquire into what services were rendered by Mr. Mordecai in securing or conserving the fund. Any service rendered by him as attorney for Mr. Simmons personally must be paid by him individually, and should not be taken out of this fund. It may be possible that the referee has already considered this, and that in allowing the sum of \$250 he has been satisfied that Mr. Mordecai has rendered services in creating or preserving the fund which entitle him to that amount, and that he has not thought it necessary to report all the testimony upon which he based his conclusion. I will not be inclined to disturb his conclusion, if, with all the lights before him, which are not before me, he should be of opinion that Mr. Mordecai has rendered services which had so far been of benefit to the fund, either in its creation or preservation, as would entitle him to the sum of \$250. All I can say at present is, with the record before me I cannot see any evidence which justifies so large an allowance.

In re HASKELL.

(District Court, S. D. New York. August 28, 1908.)

No. 7,505.

BANKRUPTCY—DISCHARGE—FAILURE TO KEEP BOOKS.

A refusal of a discharge to a bankrupt on the ground that he failed to keep books is not warranted, unless there is evidence from which, at least, it can fairly be inferred that there was an actual intent to conceal his condition. Mere negligence in the keeping of books is not sufficient.

[Ed. Note.—For cases in point, see Cent. Dig. vol. 6, Bankruptcy, § 752.]

In Bankruptcy. On application for discharge.

Arthur Falk, for bankrupt.

Felix H. Levy, for objecting creditors.

Hastings & Gleason, for trustee.

HOLT, District Judge. As I understand the referee's two reports, he finds, on the charge of omitting to make entries in his books, as facts, that the bankrupt, shortly before the bankruptcy, made seven payments to near relatives or friends, aggregating \$5,515; that the bankrupt duly reported these payments to his bookkeeper for entry in his books; that the bookkeeper omitted to enter them; that the bankrupt never made entries in or examined his books; and that this is a case of mere negligence or carelessness on the part of the bankrupt, in his general system of bookkeeping, unaccompanied by any fraudulent intent. On these facts the referee reports in favor of refusing a discharge, on the authority of the cases of *In re Hanna*, unreported, and *In re Alvord* (D. C.) 14 Am. Bankr. Rep. 264, 135 Fed. 236. He construes these cases as holding that, in the absence of an actual fraudulent intent, there may be such negligence and carelessness in a system of bookkeeping followed as to be equivalent to the intent

to conceal the financial condition mentioned in the statute. But I am not able to concur in such a construction of those cases. In the Hanna Case there was evidence tending to show that entries were omitted with intent to conceal. In the Alvord Case the bankrupt was a man of intelligence, doing a large business, who substantially omitted to keep any books at all. In both these cases the facts authorized the inference of an actual intent to conceal the financial condition, and I have no doubt that such actual intent must be established in all cases. In re Garrison, 17 Am. Bankr. Rep. 832, 149 Fed. 178, 79 C. C. A. 126.

But I am not satisfied with the referee's conclusions as to the facts in this case. He heard and saw the witnesses, and that fact is entitled to great weight. But the evidence, particularly of the bankrupt and the bookkeeper, is very unsatisfactory, when read. Both of them, particularly the bookkeeper, should have been cross-examined closely on the question of the omission to make the entries. Here are seven large payments made to relatives and friends, mostly by cash. How and when and under what circumstances did the bankrupt notify the bookkeeper of such payments? What explanation has the bookkeeper to make for not entering them, if he had notice of them? I think these points should be explained, and, if not explained, that the claim of mere negligence in bookkeeping should be rejected.

The referee, at the end of his report, says that, in view of his decision on the charge contained in the first specification, he does not make any finding on the merits on the charge of the concealment of assets, contained in the second and third specifications. I think the case should be sent back to the referee to take any additional evidence that may be offered, and to report again upon the first specification, and on the merits upon the second and third specifications. I think it proper to add that it is preferable in all cases that the referee should pass on all the grounds of objection to discharge, so as to prevent the necessity of sending the case back, if the referee's conclusions on particular charges are not concurred in by the court.

In re KYTE

(District Court, M. D. Pennsylvania. September 30, 1908.)

No. 1,035, in Bankruptcy.

BANKRUPTCY—PROVABLE CLAIMS—NOTE GIVEN BY BANKRUPT TO WIFE.

A note given by a bankrupt to his wife is provable against his estate, regardless of the consideration therefor, where it is not shown that the bankrupt was indebted at the time it was given.

In Bankruptcy. On certificate from E. Foster Heller, referee, sur exceptions to claim of Hattie S. Kyte.

W. H. Goodwin and F. C. Mosier, for exceptions.

O. F. Harvey, Jr., opposed.

ARCHBALD, District Judge. The claim of Hattie S. Kyte, the wife of the bankrupt, is based on a promissory note, with confession

of judgment, for \$3,875, dated May 15, 1906, on which judgment was entered in the common pleas of Luzerne county to No. 114, October term, 1907. The consideration of this note is said to have been money received by Mrs. Kyte by gift from her father in his lifetime and loaned to her husband, being represented originally by a similar note, similarly entered, to No. 177, January term, 1880, for \$1,245.42, this being subsequently replaced and continued by another note for \$2,500, entered to No. 44, May term, 1898; each judgment being the amount of the preceding one, with interest added.

It appears by the record, however, that the first judgment in this series was satisfied, all but about \$180, by a sheriff's sale of the personal property of Mr. Kyte, and that the second one was marked "Satisfied September 3, 1903"—there being nothing to indicate how this came about—which effectually disposes, as it is contended, of any such connection between these different judgments as is relied upon. It may be, upon this showing, if the present exceptants were creditors at the time the note in controversy was given, that the claim would have to be rejected; Mrs. Kyte being unable to furnish any very clear explanation of the transaction, so as to connect up the later judgments with the earlier ones. Stringent proof is required of a wife in Pennsylvania in a contest with her husband's creditors, which this hardly measures up to. But, whatever may be said of anything prior to the latest judgment, Mrs. Kyte is clearly able to carry back her claim to May 15, 1906, when the note upon which it is based was given to H. S. Robinson as her trustee, and even if it was a gift, and without consideration, it would be good, unless her husband was indebted at the time, which is not shown.

The referee was therefore right in sustaining the claim, and the exceptions are overruled.

FLANNELLY v. DELAWARE & H. CO.

(Circuit Court, M. D. Pennsylvania. September 30, 1908.)

No. 124, January Term, 1908.

RAILROADS—INJURY TO PERSON ON CROSSING—CONTRIBUTORY NEGLIGENCE.

Evidence *held* to warrant a finding by the jury that a plaintiff who was struck and injured while driving over a railroad crossing, was not chargeable with contributory negligence; her own testimony being that the train was not in sight when she drove upon the crossing and had given no signals, and it further appearing that she would have passed over in safety, but for the stopping or balking of her horse when the wagon was nearly off the track.

[Ed. Note.—For cases in point, see Cent. Dig. vol. 41, Railroads, §§ 1144–1149.]

At Law. On rule for judgment for defendant non obstante verdicto.

James H. Torrey, for the rule.
Paul J. Sherwood, opposed.

ARCHBALD, District Judge. The jury found that the defendant company was negligent in not giving due warning, by blowing the whistle of the engine, of the approach of the train to the crossing where the plaintiff was struck and injured, and I see no occasion to disturb that finding, in view of the conflicting evidence on the subject.

The right to judgment notwithstanding the verdict depends, therefore, on whether the plaintiff was clearly convicted of contributory negligence on the undisputed evidence. It is said that she was, by her own testimony that she drove right onto the track where she was injured as soon as the train which was passing on the track beyond had cleared the crossing, without waiting until she got an unobstructed view in the direction from which the train that struck her was coming; the view being obscured by a curve in the track, and the passing train being made up of high box cars. I confess that this was the impression I got at the trial, and I charged the jury accordingly. But upon going over the stenographer's notes I find that I was mistaken, or, at least, it was not so clear that I would have been justified in taking the case from the jury and directing a verdict, and, if so, I cannot now enter judgment notwithstanding it. The evidence, of course, was for the jury, unless so completely one way that there could be but one conclusion to be drawn from it. And the rule with regard to contributory negligence having been fully explained to them, it must be assumed that they properly applied it, and found that the plaintiff did not drive onto the tracks until she had waited a suitable time, so as to have a sufficient view and be able to make such an observation, as was required of her before doing so. Besides that, it is the uncontradicted evidence that the horse stopped or balked just as he got upon the track, without which the plaintiff would have got safely over; the train, as it was, merely striking the hind wheel of the wagon. It was thus the unexpected action of the animal which really brought about the accident; the plaintiff having apparently started in sufficient time to get across if this had not happened, the train, according to her statement, not having yet come in sight. If, therefore, she was not negligent in starting to cross, as the jury in this view of the evidence might properly find, there was nothing to stand in the way of a recovery.

And the rule for judgment non obstante veredicto must be discharged.

BLODGET v. COLUMBIA LIVE STOCK CO.†

(Circuit Court of Appeals, Ninth Circuit. October 5, 1908.)

No. 1,581.

DAMAGES—LIQUIDATED DAMAGES—VALIDITY OF STIPULATION.

In an oil and gas lease, which binds the lessee to drill a well on the property to a certain depth within a specified time, the damages for a breach of such provision being necessarily indefinite, uncertain, and speculative, it is competent for the parties to fix the amount of such damages by mutual agreement, and a provision that in case of the failure of the lessee to drill such well he shall pay a stated sum as liquidated damages is valid and enforceable.

[Ed. Note.—For cases in point, see Cent. Dig. vol. 15, Damages, § 164.]

In Error to the Circuit Court of the United States for the Northern Division of the Southern District of California.

W. S. Allen and E. W. Camp, for plaintiff in error.

Byron Waters, for defendant in error.

Before GILBERT, ROSS, and MORROW, Circuit Judges.

ROSS, Circuit Judge. The defendant in error recovered judgment in the court below in the aggregate sum of \$4,500 as liquidated damages, with interest thereon, on three certain leases of land situated in the state of Texas, in which state the leases were also made, to the plaintiff in error, for the purpose of developing oil and gas thereon, upon certain terms and conditions therein stated, each lease running for 25 years, "and as much longer as oil or gas should be produced in paying quantities," and including a provision that the lessee should have seven-eighths and the lessor one-eighth of all the oil and gas so produced by the lessee. Each lease provided that the lessee should, within a certain specified time—

"begin in good faith the sinking upon said premises of such well or wells as may be necessary to thoroughly test the said leased premises for oil and gas, and will thereafter, and as soon as satisfactory location shall be determined, begin the sinking of a deep well, the same to be drilled or sunk to a depth of 1,200 feet, unless pay oil or gas shall be encountered at a less depth, and unless before reaching that depth salt water or some geological formation be encountered that would be recognized among oil operators as a positive evidence that oil or gas would not be encountered at a greater depth. This covenant of the lessee to sink said deep well is mutually agreed to be one of the principal considerations for this lease."

Each of the leases contained these further provisions:

"That all the rights of every nature hereby leased are so leased upon the condition that if the lessee shall not in good faith commence work within the period hereinabove limited, or shall thereafter be in default for a period of 90 days in the performance of any covenants herein contained, then the lessor may at his option immediately terminate this lease, and all rights of any and every nature growing out of or appurtenant thereto of the lessee, by giving him notice in writing of its election to declare this lease and all said rights terminated. * * * In the event the above lease shall be canceled through the default of the lessee, before the lessee shall have completed a well to the depth of 1,200 feet, or discovered pay oil or gas at a lesser depth, under the conditions as hereinbefore provided, the lessee hereby obligates himself to

*Rehearing denied October 26, 1908.

either forthwith complete said well, or forfeit the sum of \$1,500 as liquidated damages for such default."

The case shows that the lessee did nothing whatever under either lease, for which default the lessor terminated each lease more than 90 days after such default. The complaint alleged that the defendant in error sustained damages in the sum of \$1,500 under each agreement. The respective parties waived a jury in writing, and tried the case before the court, which made these findings of fact:

"(1) The court finds that each and every of the facts alleged in plaintiff's complaint herein are true, except that allegation in paragraph 7 of each of the causes of action set out in the complaint, to the effect that plaintiff has sustained, by reason of said default, damages in the sum of \$1,500, as to which damages the court finds that, by reason of said default on the part of defendant, plaintiff did sustain some damage, but that the amount thereof cannot be determined from the evidence in the case, save that as by the terms of the lease said sum of \$1,500 was agreed upon as stipulated damages.

"(2) That defendant did not, in boring any well upon any of the premises leased from plaintiff, encounter any geological formation which would be recognized among oil operators, or which were or are recognized among oil operators, or by defendant, as a positive evidence, or any evidence, that oil or gas would not be encountered at a greater depth."

We think the judgment right. In the very nature of the case the damages that would result to the lessor by a breach of the leases by the lessee would necessarily be indefinite, uncertain, and speculative. It was, therefore, eminently proper that the parties should fix such damages by mutual agreement. In the case of *Sun Printing & Publishing Association v. Moore*, 183 U. S. 642, 672, 22 Sup. Ct. 240, 252, 46 L. Ed. 366, the Supreme Court, after a review of the authorities on the subject, said:

"It may, we think, fairly be stated that, when a claimed disproportion has been asserted in actions at law, it has usually been an excessive disproportion between the stipulated sum and the possible damages resulting from a trivial breach apparent on the face of the contract, and the question of disproportion has been simply an element entering into the consideration of the question of what was the intent of the parties, whether bona fide to fix the damages or to stipulate the payment of an arbitrary sum as a penalty, by way of security. In the case at bar, aside from the agreement of the parties, the damage which might be sustained by a breach of the covenant to surrender the vessel was uncertain, and the unambiguous intent of the parties was to ascertain and fix the amount of such damage. In effect, however, the effort of the petitioner on the trial was to nullify the stipulation in question by mere proof, not that the parties did not intend to fix the value of the yacht for all purposes, but that it was improvident and unwise for its agent to make such an agreement. Substantially, the petitioner claimed a greater right than it would have had if it had made application to a court of equity for relief; for it tendered in its answer no issue concerning a disproportion between the agreed and actual value, averred no fraud, surprise, or mistake, and stated no facts claimed to warrant a reformation of the agreement. Its alleged right to have eliminated from the agreement the clause in question, for that is precisely the logical result of the contention, was asserted for the first time at the trial by an offer of evidence on the subject of damages. The law does not limit an owner of property, in his dealings with private individuals respecting such property, from affixing his own estimate of its value upon a sale thereof, or on being solicited to place the property at hazard by delivering it into the custody of another for employment in a perilous adventure. If the would-be buyer or lessee is of the opinion that the value affixed to the property is exorbitant, he is at liberty to refuse to enter into a contract for its

acquisition. But if he does contract, and has induced the owner to part with his property on the faith of stipulations as to value, the purchaser or hirer, in the absence of fraud, should not have the aid of a court of equity or of law to reduce the agreed value to a sum which others may deem is the actual value. And, as pertinent to these observations, we quote from the opinion delivered by Wright, J., in *Clement v. Cash*, 21 N. Y. 253, where it was said (page 257): 'When the parties to a contract, in which the damages to be ascertained, growing out of a breach, are uncertain in amount, mutually agree that a certain sum shall be the damages, in case of a failure to perform, and in language plainly expressive of such agreement, I know of no sound principle or rule applicable to the construction of contracts that will enable a court of law to say that they intended something else. Where the sum fixed is greatly disproportionate to the presumed actual damages, probably a court of equity may relieve; but a court of law has no right to erroneously construe the intention of the parties, when clearly expressed, in the endeavor to make better contracts for them than they have made for themselves. In these, as in all other cases, the courts are bound to ascertain and carry into effect the true intent of the parties. I am not disposed to deny that a case may arise in which it is doubtful, from the language employed in the instrument, whether the parties meant to agree upon the measure of compensation to the injured party in case of a breach. In such cases there would be room for construction; but certainly none where the meaning of the parties was evident and unmistakable. When they declare, in distinct and unequivocal terms, that they have settled and ascertained the damages to be \$500, or any other sum, to be paid by either party failing to perform, it seems absurd for a court to tell them that it has looked into the contract and reached the conclusion that no such thing was intended, but that the intention was to name the sum as a penalty to cover any damages that might be proved to have been sustained by a breach of the agreement.'

In *United States v. Bethlehem Steel Company*, 205 U. S. 105, 118, 731, 450, 455, 51 L. Ed. 731, the court said:

"There has in almost innumerable instances been a question as to the meaning of language used in that part of a contract which related to the payment of damages for its nonfulfillment, whether the provision therein made was one for liquidated damages, or whether it meant a penalty simply, the damages to be proved up to the amount of the penalty. This contract might be considered as being one of that class where a doubt might be claimed, if nothing but the contract were examined. The courts at one time seemed to be quite strong in their views, and would scarcely admit that there ever was a valid contract providing for liquidated damages. Their tendency was to construe the language as a penalty, so that nothing but the actual damages sustained by the party aggrieved could be recovered. Subsequently the courts became more tolerant of such provisions, and have now become strongly inclined to allow parties to make their own contracts, and to carry out their intentions, even when it would result in the recovery of an amount stated as liquidated damages, upon proof of the violation of the contract, and without proof of the damages actually sustained. This whole subject is reviewed in *Sun Printing & Publishing Association v. Moore*, 183 U. S. 642, 669, 22 Sup. Ct. 240, 46 L. Ed. 366, where a large number of authorities upon this subject are referred to. The principle decided in that case is much like the contention of the government herein. The question always is, what did the parties intend by the language used? When such intention is ascertained, it is ordinarily the duty of the court to carry it out. See, also, *Clement v. Cash*, 21 N. Y. 253, 257; *Little v. Banks*, 85 N. Y. 258, 266."

A case quite similar, in some respects, to that at bar—*Escondido Oil, etc., Co. v. Glaser*, 144 Cal. 494, 77 Pac. 1040—came before the Supreme Court of California, where that court said:

"There are two counts in the complaint. In the first count judgment for \$500 as liquidated damages is prayed for, and in the second count actual dam-

ages in a larger amount named. Respondent contends that this is not a case where there could be a valid agreement for liquidated damages, under sections 1670 and 1671 of the Civil Code; but, as there is no special demurrer to the first count on that ground, the complaint, if good for actual damages, is not reached by the demurrer. However, as the case may be hereafter tried on its merits, it is proper to say that, in our opinion, the agreement for liquidated damages should be upheld. The complaint sufficiently states the character and subject-matter of the contract—"the nature of the case," to use the language of section 1671—to show that upon its breach 'it would be impracticable or extremely difficult to fix the actual damages.' Fixing the amount for damages sustained in contracts for digging oil wells very similar to the one here involved was upheld in *Gibson v. Oliver*, 158 Pa. 277, 27 Atl. 961, and the cases there cited. And it would seem that damages for breaches of contracts touching future interest in oil wells of unknown value are of such remote and speculative character as to bring them peculiarly within the rule that the parties should have the right to fix them by mutual agreement. In the case at bar the right of plaintiff, under the contract with the insurance company, to test the land, and to acquire a valuable interest therein if the test prove successful, was limited in time, and that right might be lost by a failure of defendant to comply with his contract; and it was quite apparent that in such event it would be entirely impracticable to show plaintiff's loss, or what otherwise would have been his gain. And the small amount provided in the contract herein involved as liquidated damages is certainly not unconscionable."

The judgment is affirmed.

BUTTE ELECTRIC RY. CO. v. JONES.

(Circuit Court of Appeals, Ninth Circuit. October 5, 1908.)

No. 1,522.

DEATH—ACTION FOR WRONGFUL DEATH—MEASURE OF DAMAGES TO MINOR CHILD.

In an action on behalf of a minor to recover damages for the wrongful death of his mother, under a statute authorizing a recovery of such damages "as under all the circumstances of the case may be just," the recovery is not limited to the pecuniary loss suffered by the minor prior to his majority, and the jury may properly consider evidence tending to show that he was by his mother's death deprived of a home, that he was dependent on her earnings for the means of his education, and that she intended to send him to college and earned sufficient to have enabled her to do so.

In Error to the Circuit Court of the United States for the District of Montana.

W. M. Bickford and Geo. F. Shelton, for plaintiff in error.
E. N. Harwood, for defendant in error.

Before GILBERT, ROSS, and MORROW, Circuit Judges.

ROSS, Circuit Judge. This action was brought in the court below by the administrator of the estate of Josephine I. Jacobs, deceased, against the plaintiff in error, to recover damages growing out of the death of the deceased, which the complaint alleged to have been caused by the negligence of the defendant railway company. It also alleged that the deceased left surviving her a son, Harry B. Jacobs, who

was, at the time of her death, 17 years of age; that "the said Harry B. Jacobs, the minor heir of said deceased, had no other means of maintenance or education than that provided for by his mother from her earnings; and that by reason of her death said Harry B. Jacobs had been deprived of home and maintenance and opportunity of education." The allegations quoted were put in issue by the answer of the defendant company. The trial resulted in a verdict of \$4,000, upon which judgment against the company was entered, with costs.

The brief of the plaintiff in error states:

"It was practically admitted, and there was no substantial controversy as to the negligence of the defendant, as alleged in the complaint. The questions presented for consideration of the court and jury throughout the trial were: First, whether the plaintiff had any right in law to maintain the suit; second, whether, in case he had, a recovery must be confined to the damages suffered by the estate alone, or whether the damages suffered by the minor heir were proper to be awarded by the jury; and, third, if the damages suffered by the minor heir were proper to be considered by the court and jury, what was the measure of the damages suffered by him?"

The first two questions thus referred to were decided by us adversely to the contention of the plaintiff in error in the recent case of *Alder Company v. Fleming, Administrator*, 159 Fed. 593, leaving the sole questions for decision in the present case those growing out of the proper measure of damages.

In the course of the trial the counsel for the defendant contended that the recovery, if any, should be limited to the pecuniary loss suffered by the minor heir prior to his majority. The court ruled against that contention, and, in instructing the jury upon the subject of damages, told them that in ascertaining such damages they were "not confined to the period prior to, or only up to, the time when said Harry B. Jacobs would arrive at the age of 21 years." The defendant reserved an exception to the action of the court in each of those particulars. We think the ruling right.

Counsel cite in support of the point *Stoher v. St. Louis, etc., Ry. Co.*, 91 Mo. 509, 4 S. W. 389, and *David v. Southwestern R. R. Co.*, 41 Ga. 223. So far as can be seen from the opinions in those cases, in neither one was the precise point adjudged or presented. In *Stoher v. St. Louis, etc., Ry. Co.*, an infant, by her next friend, brought the action to recover damages for the death of her father. We do not find in the opinion in that case any suggestion favorable to the contention of the plaintiff in error here, but, on the contrary, an implied approval of the case of *Tilley v. Hudson River R. R. Co.*, 29 N. Y. 252, 86 Am. Dec. 297, hereinafter referred to. The case of *David v. Southwestern R. R. Co.* was originally brought by the widow of one Charles Rogers, who was killed by an engine on the Southwestern Railroad, pending which action the widow died, leaving minor children of herself and her deceased husband. David, as prochien ami of the minors, was made a party plaintiff to the action and prosecuted it for the benefit of the minors. The question presented to the Supreme Court of the state related to the proper measure of damages in the action by the children. The language of the section is not given in the opinion of the court, but the court does expressly state that it

"is not so clear as the importance of the subject demands," and in disposing of the question before it, said:

"We decided, in *Johnson v. Macon & W. R. Co.*, 38 Ga. 433, that, if the widow sued, the measure of damages was the present worth of a reasonable support of herself according to the expectation of the husband's life, in view of his condition in life, etc. The same rule ought to be applied when the children sue. The measure of damages in such a case is the present worth of a reasonable support for them during the minority, according to the expectation of the father's life, in view of his condition of life, prospects, industry, etc. We think, upon the whole, this best conforms to the words and intent of the act, although, as we have said, the meaning is not as clear as it ought to have been."

The precise point here involved was, however, presented to the Supreme Court of California in the case of *Redfield v. Oakland C. S. Railway Co.*, 110 Cal. 277, 42 Pac. 822, 1063, and in *Tilley v. H. R. R. Co.*, 29 N. Y. 252, 86 Am. Dec. 297, the first of which cases was based upon a statute precisely similar to the Montana statute upon which the present action is based, and the other upon a statute similar in effect, and in each of which cases it was held that there is no sufficient legal reason for limiting the damages in such an action to the minority of the minor, if the jury find that they will continue after that age.

The counsel for the defendant also excepted to a line of testimony, admitted in evidence over their objections, tending to show that the deceased intended to send her son to college, and, with that end in view, had secured from various colleges catalogues and circulars tending to show the cost of maintenance at certain institutions and the conditions of entry therein. There was also evidence tending to show that, more than a year before his mother's death, the son, when in the eighth grade of the public schools, had left school and gone to work for wages as house boy or steward in private residences, and at one time in a club, visiting his mother only at intervals; and it is argued for the plaintiff in error that under such circumstances—

"the idea that he had suffered by reason of the death of his mother the loss of an opportunity of attending college rested upon the merest conjecture, speculation, and fancy."

It is further argued by counsel that:

"There was no reasonable or probable basis upon which it could be assumed that the accomplishment of any of these ambitions or desires could have been secured, and that neither the capacity of the boy, nor his aptitude, pointed to any result of that character."

That argument would have been appropriate for the consideration of the jury, but is not pertinent here. There was, as has been said, evidence tending to show that the mother intended to send her son to college, and there was evidence tending to show that she was able to do so; for, although it appears that she left but a few hundred dollars in money, the evidence also tended to show that she was an industrious woman, being a laundress and cateress in the city of Butte, Mont., in which occupations her earnings, it seems, were good and substantial; and, while the evidence also indicates that she did not lay by much money, it does not necessarily follow that she would continue

a free spender if she had lived and carried out her declared intention of sending the boy to college. The evidence also tended to show that the deceased was a kindly woman, bore an excellent character among her neighbors and friends, and furnished her son a good home while he was living with her. We cannot agree with counsel for the plaintiff in error that those circumstances were improperly admitted in evidence by the court, for they tended to show that the mother afforded the minor son a good home, of which he was at liberty to avail himself, and of which he was deprived by her death—to what amount of pecuniary damage it was for the jury to say.

We think it cannot be properly held that the defendant in error suffered no direct pecuniary loss by such deprivation. The language of the statute under which the action at bar was brought is:

“That such damages may be given as, under all the circumstances of the case, may be just.”

The court below distinctly, and properly, instructed the jury that they could award damages as a pecuniary compensation only, and could not take into consideration the grief of the son, nor make any allowance for solace to him.

The judgment is affirmed.

GAUDETTE v. GRAHAM.

In re BLANCHARD SHINGLE CO.

(Circuit Court of Appeals, Ninth Circuit. October 5, 1908.)

No. 1,580.

1. **BANKRUPTCY—APPEALS—MODE OF REVIEW.**

An appeal from a decision of a District Court in bankruptcy can be treated as a petition for review only where questions of law are alone involved.

2. **SAME.**

An order of a District Court allowing a claim against an estate in bankruptcy as a general debt, but disallowing in part a claim of the creditor to priority as a lien holder, is not appealable by the creditor, under Bankr. Act July 1, 1898, c. 541, § 25a (3), 30 Stat. 553 (U. S. Comp. St. 1901, p. 3432); nor is it subject to revision on petition under section 24b, where it depends on controverted facts.

[Ed. Note.—Appeal and review in bankruptcy cases, see note to In re Eggert, 3 C. C. A. 9.]

Appeal from the District Court of the United States for the Northern Division of the Western District of Washington.

Million & Houser and Kerr & McCord, for appellant.

Corwin S. Shank, Winfield S. Smith, J. W. Rose, and A. J. Craven, for appellee.

Before GILBERT, ROSS, and MORROW, Circuit Judges.

ROSS, Circuit Judge. The appellant's assignor had duly filed a materialman's lien for \$2,338.07 against the Blanchard Shingle Company, the bankrupt in this case, pursuant to a statute of the state of

Washington, where the case arose, and had just begun a suit in one of the courts of the state of Washington to foreclose the lien, when the bankruptcy proceedings were commenced. After the commencement of those proceedings the claimant filed a preferred claim for the \$2,338.07, and for \$100 as an attorney fee for instituting the foreclosure suit. The trustee objected to the entire claim, and on the hearing before the referee the appellant abandoned his claim of lien as to one item of \$42.88 included in the \$2,338.07. The referee allowed this \$42.88 item as a common claim, and the remaining \$2,295.19 as a lien, but refused to allow any attorney fee. Each party applied to the District Court for a review of the decision of the referee; the trustee because any lien was allowed, and the claimant because the fee was disallowed. The District Court affirmed the disallowance of the attorney fee, and, in view of the facts of the case, cut down the lien from \$2,295.19 to \$585.41, but allowed as a common claim against the estate the entire remainder. From that order the claimant brought the present appeal, to dismiss which a motion is made by the appellee.

As in the case a consideration of the facts is essential to any review of the decision of the court complained of, it is clear that the appeal cannot be treated as a petition for revision, as is suggested by the appellant may be done. That is only permissible where questions of law only are involved. *In re Williams' Estate*, 156 Fed. 934, 84 C. C. A. 434; *In re Rouse, Hazard & Co.*, 91 Fed. 96, 98, 33 C. C. A. 356; *Courier-Journal Job Printing Company v. Shaeffer-Meyer Brewing Company*, 101 Fed. 699, 41 C. C. A. 614. *Bankr. Act July 1, 1898*, c. 541, § 24b, 30 Stat. 553 (U. S. Comp. St. 1901, p. 3432); provides that:

"The several Circuit Courts of Appeal shall have jurisdiction in equity, either interlocutory or final, to superintend and revise in matter of law, the proceedings of the several inferior courts of bankruptcy within their jurisdiction. Such power shall be exercised on due notice and petition by any party aggrieved."

And section 25a of the same act provides that:

"Appeals, as in equity cases, may be taken in bankruptcy proceedings from the courts of bankruptcy to the Circuit Court of Appeals of the United States, and to the Supreme Court of the territories, in the following cases, to wit: (1) From a judgment adjudging or refusing to adjudge the defendant a bankrupt; (2) from a judgment granting or denying a discharge; and (3) from a judgment allowing or rejecting a debt or claim of five hundred dollars or over."

As the attorney fee claimed in the present case only amounted to \$100, and the court allowed the full amount of the debt to the appellant as a common claim, it is apparent that, if the appeal lies, it can only be because of the rejection by the court (except to the extent of \$585.41) of the appellant's asserted lien for the debt.

In the case of *In re Worcester County*, 102 Fed. 808, 812, 42 C. C. A. 637, the Circuit Court of Appeals for the First Circuit had under consideration the provisions of the bankrupt act here involved, and said:

"Whether or not we shall take jurisdiction of the matters now before us on a petition for revision or on appeal is a substantial question, because on a petition for revision we are limited to matters of law, while on appeal the whole record is open. The right of appeal is applied, so far as the amount

is concerned, to debts of \$500 or over; thus indicating a settled determination on the part of Congress not to leave the final decision of a right to prove a considerable claim in the power of a single judge in any part. It becomes at once apparent that this substantial right of appeal ought not to be taken away merely because the party who proves a debt also claims a priority in connection therewith. It becomes necessary in this connection to examine somewhat further the provisions of the statute of 1898 with reference to the method of proving claims, and also the general orders and forms in bankruptcy relating thereto. Nothing is found in the orders giving any special direction with reference to the manner of proving claims in connection with which a priority is asserted. Neither do the prescribed forms for proofs of debts contain anything of that character, although the form of the proof of a secured debt requires that it shall enumerate the securities held by the creditor. Neither is there anything in the statute giving any direction as to the method of proving a debt in reference to a priority. The topic is covered by section 57 (30 Stat. 560 [U. S. Comp. St. 1901, p. 3443]). The first paragraph of that section ('a') gives detailed directions for the proof, but it omits any reference to the matter of priority, although it is express about proofs by creditors holding securities. Paragraph 'e' provides that the claims of secured creditors and of those who have priorities may be allowed, in order to enable such creditors to participate at meetings held prior to the determination of the value of their securities or priorities, but they are thus to be allowed for such sums only as to the court seems to be owing over and above the value of their securities or priority. This, however, concerns only the preliminary determination in a preliminary way of the franchise rights of creditors. Section 64 (30 Stat. 563 [U. S. Comp. St. 1901, p. 3447]), which fixes priorities, commences with a direction that the court shall order the trustee to pay taxes due various enumerated entities in advance of the payment of dividends. It proceeds, in the next paragraph, that the 'debts to have priority, except as herein provided, and to be paid in full out of bankrupt estates, and the order of payments shall be: [Then comes the enumeration of the various classes of debts, 1 to 5, which we need not repeat.] There is nothing in this section to indicate that the question of priority is essentially involved in the mere matter of proving a debt, or even that a claim to priority should appear in the formal proof. In Act March 2, 1867, c. 176, 14 Stat. 530, afterwards found in section 5101 of the Revised Statutes, which covered the entire matter of priority, the matter was put clearly as follows: 'In the order for a dividend, the following claims shall be entitled to priority and are to be first paid in full in the following manner.' Then is given a schedule of the different classes of priority claims. We can conveniently place our hands on only two cases showing the method of proceeding under that statute, which are *In re Handell*, 15 Nat. Bankr. Rep. 71, Fed. Cas. No. 6,017, and *Ex parte Rockett*, 15 Nat. Bankr. Rep. 95, Fed. Cas. No. 11,977, in each of which the question of priority was treated purely as one of administration, and was not connected with the proofs of debts. On the whole, Congress having provided specifically in the act of 1898 for an appeal with reference to proofs of debts exceeding \$500, on which appeals all questions are open to the appellate tribunal, and having also provided that, for all matters of administration which concern the relations to each other of the different interests in the estate, the action of the bankruptcy court shall be revised only in matters of law, it is plain that Congress insisted on a distinction of a substantial nature, which we are not at liberty to disregard. Whether or not the county of Worcester has any debt provable belongs in the first class. Whether or not it has any debt as to which it is entitled to priority is a question of administration, which can ordinarily present no question of importance, except of law, arising from facts which can rarely be disputed. Therefore it belongs of right to the second class. The fact that, for convenience, the learned judge of the District Court combined both questions in one decree, can in no way affect the substantial distinctions which Congress has made between the mere power to revise and a full appeal. We therefore must sever what the District Court has apparently combined. Inasmuch as the trustee maintains that the county of Worcester has no debt which it can prove for any purpose against the bankrupt estate, we must dispose of that

question on the appeal; and, inasmuch as he also claims that, even if the county has a provable debt, it is not entitled to any priority, we must dispose of that question on the petition for revision. The Circuit Court of Appeals for the Seventh Circuit had this topic under consideration in *Re Rouse, Hazard & Co.*, 33 C. C. A. 356, 91 Fed. 96, although not before it in the precise form in which it comes before us. The only question there was that of priority, and the court held that this was not governed by the provisions of section 25 granting appeals. The opinion observed, however, at the foot of page 98, 91 Fed., and page 358, 33 C. C. A., that, if the controversy had been in respect to the merits of the claims, the court would have been without jurisdiction on a petition for revision. The line of reasoning would have led to the same result which we have reached, if the matter had come up in the same form."

In *re Worcester County*, just quoted from, as well as *In re Rouse, Hazard & Co.*, 91 Fed. 96, 33 C. C. A. 356, were referred to with approval by the Supreme Court in the case of *Hutchinson v. Otis*, 190 U. S. 552, 555, 23 Sup. Ct. 778, 779, 47 L. Ed. 1179, where that court said:

"A petition was filed by Otis, Wilcox & Co., asserting a lien on the proceeds of a seat in the New York Stock Exchange, which formerly belonged to the bankrupts. This lien had not been insisted on by Otis, Wilcox & Co., because of their impression that they had been paid effectually. No one having changed his position on the faith of their waiver, the District Court allowed the lien. The Circuit Court of Appeals held that this portion of the decree of the District Court was not subject to an appeal to the Circuit Court of Appeals. The argument chiefly relied upon by the appellant is that this is an intervening petition to reach a fund in court, and is not a proceeding in bankruptcy. Under the circumstances of this case, it seems to us that the petition was incident to the claim (*Cunningham v. German Insurance Bank* 101 Fed. 977, 41 C. C. A. 609; s. c. 4 Am. Bankr. Rep. 192, 103 Fed. 932, 43 C. C. A. 377), and was a bankruptcy proceeding under section 2, cl. 7, within the meaning of section 25, regulating appeals in bankruptcy proceedings, and that the decree upon it was not 'a judgment allowing or rejecting a debt or claim of five hundred dollars or over' within section 25a (3), and was not an independent ground of appeal."

In the light of these authorities, it seems that the case at bar is not appealable under section 25a of the bankrupt act, and, as the record shows that the asserted lien of the appellant depends upon controverted facts, it clearly is not subject to revision under section 24b.

The appeal is dismissed.

THE PRINTER.

(Circuit Court of Appeals, Ninth Circuit. October 5, 1908.)

No. 1,550.

1. TOWAGE—DUTY OF TUG—ANCHORING OF TOW.

The duty of a tug to a tow is a continuous one from the time the service commences until it is completed, and where it becomes necessary to anchor the tow the tug's obligation of reasonable care continues, at least until she is safely anchored.

[Ed. Note.—For cases in point, see Cent. Dig. vol. 45, Towage, §§ 4, 23.]

2. SAME—LOSS OF TOW—INSUFFICIENT ANCHORAGE.

A tug, which had engaged to tow two schooners out of Gray's Harbor, after starting, anchored the tows to await a more favorable tide for crossing the bar, and then left them until the next day. The tide was ebb, and the wind strong from the east, and later increased. At once

one of the vessels commenced to drift; it appearing that the anchor chain parted. After she had drifted past the other vessel, she dropped another anchor, the chain of which also parted, and she drifted on the bar and was wrecked. On casting off the hawser at the anchorage the tug immediately left, without waiting to see whether the schooner's anchor held, and paid no further attention to her, although she made signals of distress before the tug was out of sight. *Held*, that the evidence supported a finding by the trial court that the schooner was in fault because of her defective anchor chains, and also that the tug was in fault in failing to stand by until the anchorage was seen to be safe, and that the damages were properly divided.

Appeal from the District Court of the United States for the Western Division of the Western District of Washington.

For opinion below, see 155 Fed. 441.

Austin E. Griffiths, for appellant.

H. W. Hutton and W. L. Sachse, for appellees.

Before GILBERT, ROSS, and MORROW, Circuit Judges.

GILBERT, Circuit Judge. The steam tug Printer, which for many years had been engaged in the business of towing in Gray's Harbor, Wash., undertook to tow the three-masted schooner Alcalde, together with the schooner W. J. Patterson, both loaded for sea, from Aberdeen outward across the bar to sea. The tug proceeded with the tows on her course toward the ocean, and at about 1 o'clock in the afternoon arrived at a point some eight miles below Aberdeen, where it was customary to anchor vessels to await time and tide for crossing the bar. The tide had then begun to ebb, and it was not deemed safe to cross the bar on the ebb tide. The tug directed the Alcalde to let go the tow line, put her helm to starboard, and anchor, which was done. The tug then placed the Patterson about three-quarters of a mile further down stream, and left her there at anchor. The captain of the tug, believing the Alcalde to be anchored too near the mud flats for safety, returned to that vessel, towed her to a better position, but at about the same distance from the Patterson as before, and directed her to let go the tow line, and anchor. The port anchor of the Alcalde was dropped, and about 30 or 40 fathoms of chain paid out. As soon as the tow line was let go, the tug steamed away to Hoquiam, intending to return on the following day and complete the contract by towing both vessels out to sea. The second anchorage of the Alcalde was made shortly before 2 o'clock. The ebb tide was then running with a considerable current. The weather was cloudy and wet, and a strong east wind was blowing. According to the reports from the weather station at North Head, 40 or 50 miles from Aberdeen, the velocity of the wind until 1 o'clock p. m. was from 16 to 21 miles per hour. During the afternoon it increased to 28 miles per hour, and continued to increase to 39 miles per hour at midnight; the highest velocity during the day being 44 miles. The force of the current and wind was such that immediately after she was anchored the Alcalde began to drift, and she continued to drift until she was wrecked on the bar. She carried a port anchor weighing about 1,400 pounds, a starboard anchor of about 1,600 pounds, and a kedge.

The only evidence as to the cause of her drifting and final wreck is that afforded by the officers and men of the *Alcalde*. Their evidence indicates that the port anchor, dropped at the time when the tug let go, never held, and that the vessel never fetched up; that they could not at first have dropped two anchors, for the reason that when the *Alcalde* commenced to drift she got close to the *Patterson*, and there was danger of her getting foul of that vessel, so that they were forced to let her drift by; that as soon as she got safely by the *Patterson* the *Alcalde* dropped her starboard anchor, and that after paying out about 40 fathoms on that anchor, the vessel still drifting, the chain of that anchor parted; that they then paid out up to 50 fathoms on the port anchor chain, and dropped the kedge anchor, connected with a 5-inch line; that the port anchor chain then parted; that the vessel had drifted about a mile when the first anchor chain broke, and about two miles when the second chain broke; that after the breaking of the second anchor chain they could still see the tug, and they hoisted the ensign *Union* down, as a distress signal, but the tug did not respond; that they then tried to make sail to force the vessel over the bar, but were unable to do so on account of the strong wind and the wet sails.

Upon a consideration of the evidence, the court below reached the conclusion that the port anchor was not dragged at all, and that the chain thereof parted as soon as the anchor took hold on the bottom, and that the vessel went adrift for the sole reason that each of her chains successively broke immediately on being subjected to the strain of the vessel. This conclusion was reached upon the testimony of some of the libelant's witnesses, to the effect that the vessel was not held by her port anchor at all, and, second, upon the evidence that the chains were weak and incapable of standing severe strain. Said the court:

"Under the same conditions, one chain held a larger vessel near the place where the *Alcalde* started to drift, and it is a self-evident proposition that a good anchor with a sufficient length of good chain would have held the *Alcalde* also."

The court held that the unsuitableness of the anchor chains was a contributing and the principal cause of the loss of the vessel, but held, also, that after having undertaken to tow the *Alcalde* to sea it was the duty of the tug to exercise ordinary care and vigilance for the safety of the tow until the contract was completely performed, and that the tug was negligent in not spacing the two schooners sufficiently far apart, and in not standing by and rendering assistance when the *Alcalde* commenced to drift, and in leaving her to her own resources with undue haste. Upon these considerations the court was of the opinion that the loss should be divided, and accordingly a decree was entered in favor of the libelants for one-half thereof, in the sum of \$5,350, and directing that the taxable costs be divided equally. From that decree the claimants of the tug have appealed.

We find no ground to disturb the conclusion of the District Court that the tug was negligent in leaving the schooner with undue haste, and in not standing by to see that she was safely anchored. The preponderance of the evidence is that immediately after the tow line was

cast off the tug proceeded on her way, and all of the evidence is that after she started no one on board of her saw the schooner or ever looked in her direction. If any one on board the tug had looked, he must have observed that the *Alcalde* was drifting. If the *Alcalde* had been brought to on the tow line and held until her anchor took hold, it is probable that the anchor would have continued to hold. As it was, she was let go in a strong ebb tide, while a high wind was blowing in the direction of the current. It is obvious that, if she commenced to drift before her anchor held, her momentum must have been such as to put a greatly increased strain upon the chain whenever the anchor began to hold. The master of the tug undertook a certain towage service. He was prevented from the continuous performance of that service by the condition of the tide. But the duty of the tug to the schooner was a continuing one from the time when she was taken in tow until the completion of the towage contract. The tug's duty did not end with letting go the tow line at the anchorage grounds. Its obligation of reasonable care continued, at least until the schooner was safely anchored. *Connolly v. Ross* (D. C.) 11 Fed. 342; *The Snap* (D. C.) 24 Fed. 510; *Hastorf v. The Governor* (D. C.) 77 Fed. 1000; *Hughes v. Railroad Co.* (D. C.) 93 Fed. 310; *The Thomas Purcell, Jr.*, 92 Fed. 406, 34 C. C. A. 419; *The American Eagle* (D. C.) 54 Fed. 1010; *The Battler* (D. C.) 55 Fed. 1006; *Alaska Commercial Co. v. Williams*, 128 Fed. 362, 63 C. C. A. 92; *Brown et al. v. Cornell Steamboat Co.* (D. C.) 110 Fed. 780.

In the case last cited a tug undertook to tow a scow, and left her at 6 p. m., promising to return the next day and resume the service. At the time when the scow was left, the weather was not considered so bad as to render it negligent to leave it where it was. Later it became worse; but the tug did not return to the scow to take it to a safer place, although she could readily have done so. The scow was not provided with an anchor, and during the night, after the storm had greatly increased, it broke from the scow to which it was fastened and drifted on the rocks. The court, in dividing the loss, held that the scow was in fault for not having an anchor, but that the tug was in charge of the scow from the time when it was taken from its moorings, and was charged with notice that it probably had no anchor, and with the duty of returning and taking it to a less dangerous place.

The appellees contend that upon the evidence taken in the court below as to the condition of the anchor chains on the *Alcalde*, aided by the new evidencé on that subject taken in this court, it is shown that the chains were not defective, and that therefore the whole of the loss should fall upon the appellants. It is to be admitted that there is much in the evidence, especially in that which was last taken, to cast serious doubt upon the testimony that the chain links which were offered in evidence in the court below as samples of the anchor chain found on the wrecked vessel were portions of the anchor chains actually in use prior to the wreck. Considering the evidence as a whole, however, we are not convinced that the conclusion reached by the District Court was erroneous. We are much impressed by the fact, as found by the court, that the anchor chains parted under conditions in which, if they had

been sufficiently strong for the purpose for which they were used, they would have held the vessel.

The decree is affirmed, with costs to the appellees.

CLAPP v. LEAVENS et al.

(Circuit Court of Appeals, Eighth Circuit. September 14, 1908.)

No. 2,736.

1. LIMITATION OF ACTIONS—SUIT TO RECOVER REAL PROPERTY—MISSOURI STATUTE.

Rev. St. Mo. 1899, § 4262 (Ann. St. 1906, p. 2335), which limits the time within which an action may be brought for the recovery of lands to 10 years, and which under the decisions of the state Supreme Court applies to all suits, whether legal or equitable, may be invoked in a federal court by a purchaser in possession under a deed executed on a foreclosure sale in a suit by the mortgagor to redeem, where the possession of the defendant was adverse.

2. SAME.

Complainant alleged in his bill that his grantor executed a mortgage on the land in controversy from the proceeds of which the mortgagee agreed to pay off a prior mortgage; that he paid such mortgage, but took an assignment thereof and foreclosed it, becoming the purchaser at the foreclosure sale; that complainant, who had become the owner of the land, was present at the sale and gave notice that the mortgage under which it was made had been paid; that the purchaser shortly after the sale took possession of the land, and he and his grantees had remained in possession since, a period of more than 10 years. *Held*, that such possession was referable solely to the first mortgage, and adverse, and that a suit to recover the land by redeeming from the second mortgage was barred by Rev. St. Mo. 1899, § 4262 (Ann. St. 1906, p. 2335).

3. SAME—RUNNING OF STATUTE—IGNORANCE OF RIGHTS.

The mere ignorance of a plaintiff of his cause of action will not prevent the running of the statute of limitations, but there must have been some concealment of facts which ordinary diligence could not discover.

4. MORTGAGES—REDEMPTION FROM FORECLOSURE SALE—FINANCIAL INABILITY TO REDEEM.

The fact that a mortgagor was not financially able to redeem from a foreclosure sale will not prevent the running of the statute of limitations against his right to redeem.

Appeal from the Circuit Court of the United States for the Western District of Missouri.

Addison Brown, for appellant.

C. W. Hamlin (Kirk Hawkins and W. D. Tatlow, on the brief), for appellees.

Before SANBORN and VAN DEVANTER, Circuit Judges, and W. H. MUNGER, District Judge.

W. H. MUNGER, District Judge. From the decree of the Circuit Court, sustaining a demurrer to a bill, this appeal is prosecuted. The bill, in substance, alleged that one Alexander Clapp was seised in fee of the real estate in question, and that on April 16, 1887, he executed a deed of trust to one H. B. Leavens, as trustee, to secure to

the New England Trust Company the payment of a note for \$5,000, due April 1, 1893, with annual interest thereon, which trust deed provided for the substitution by the beneficiary of a trustee when the trustee named refused to act. On November 12, 1890, he executed to one McHaffie a deed of trust upon the lands in question to secure the sum of \$742. Subsequently several judgment liens were obtained by different persons upon said land. For the purpose of paying off all of said incumbrances Alexander Clapp, on November 12, 1890, executed to one John O'Day a deed of trust to secure the sum of \$7,500, due November 12, 1895, with annual interest coupons. It is alleged that O'Day was to pay off all the prior incumbrances with the \$7,500; that he paid to the New England Trust Company the amount due it, and took an assignment of the note held by it, to enable him to satisfy of record the trust deed securing it, which he agreed to do; and that he paid off the McHaffie mortgage, but did not pay any of the judgments, and did not satisfy of record the deed of trust so assigned to him for that purpose.

It is also alleged in the bill that, for the purpose of cutting off and defeating the liens of said judgments and preventing the redemption of said land from the deed of trust and obtaining title to the lands at less than their value, O'Day, in February, 1892, without any refusal to act on the part of said H. B. Leavens as trustee, substituted one E. C. O'Day as trustee, and caused to be published a notice that a sale of said lands would be had under the power contained in the deed of trust to secure said New England Trust Company, said sale to take place March 19, 1892, and that on January 21, 1891, Alexander Clapp conveyed by warranty deed the lands in question to this plaintiff. At the time and place the said lands were advertised to be sold under the power contained in the trust deed to secure the New England Trust Company, to wit, March 19, 1892, plaintiff was present and gave public notice to the bystanders that the deed of trust under which the sale was being made had been fully paid and should have been released of record; that by reason of having failed in business plaintiff was insolvent at said time, and could not raise any money with which to offer to redeem said land, and has never since said sale until the present time, owing to lack of money, been able to redeem said land. The sale was made, however, and the lands bid in by O'Day for the sum of \$3,000. It is alleged that the lands were worth \$12,000. The bill says:

"That soon after said sale the plaintiff, knowing the same to have been wholly unauthorized and void, and knowing that the said John O'Day was the holder of the \$7,500 deed of trust, permitted said O'Day to take possession of said farm because he was the holder thereof."

It is alleged that O'Day, and those claiming under him, have ever since been in continuous possession of said premises, receiving the rents and profits thereof, have cut large amounts of timber therefrom, and have refused to account to plaintiff. June 1, 1893, O'Day conveyed by warranty deed portions of the land to one J. W. Barron. July 23, 1894, O'Day conveyed by warranty deed other portions of the lands to one J. R. Willyard. July 31, 1895, O'Day conveyed by war-

ranty deed to Edward and Ella Young the remaining portion of said lands. Various trust deeds and various conveyances have subsequently been made of said lands by said purchasers. It is alleged in the bill:

"That each and all the several grantees, and R. U. Sprague, mentioned in the foregoing deeds and deeds of trust, before the purchase by them, or the loan or the payment of the purchase price by them, had had notice of the herein claim and right of plaintiff in the said land, and of his intention to assert his claim thereto and his rights thereunder."

July 30, 1901, said John O'Day died, and defendants E. W. Banister and Sue Baldwin O'Day became executors of his estate. The bill prays for an accounting of the rents and profits since said sale under the trust deed to the New England Trust Company, that plaintiff may redeem from the \$7,500 mortgage, that the sale made to John O'Day under the trust deed to secure the New England Trust Company be annulled, set aside, and held for naught, and that upon payment by plaintiff of whatever may be found to be due upon the \$7,500 mortgage the several defendants be ordered and decreed to surrender and deliver up possession of the premises to plaintiff.

The several defendants demurred to the bill upon the ground that the cause of action was barred by the statute of limitations and by laches on the part of the plaintiff.

The case of *Stout v. Rigney*, 107 Fed. 545, 46 C. C. A. 459, was in all respects very similar to this one, and in that case Judge Thayer, writing the opinion of this court, discussed the statute of limitations of the state of Missouri, and the decisions of the Supreme Court of that state relative to the same, so fully that it is unnecessary for us now to again go over the same ground. It is sufficient to say that the Supreme Court of the state, in construing the statute of limitations of that state, have held that adverse possession of real estate during the 10-year period of the statute is not only a bar to an action to recover possession, but vests title in such adverse holder. *Barry v. Otto et al.*, 56 Mo. 177; *Ridgeway v. Hulday*, 59 Mo. 444; *Scannell v. American Soda Fountain Co.*, 161 Mo. 606, 61 S. W. 889. It has also been held that the statute of limitations of the state is applicable to all actions, equitable as well as legal. *Rogers v. Brown et al.*, 61 Mo. 187; *Cockrill v. Stafford*, 102 Mo. 57, 14 S. W. 813. In the last cited case it is said:

"As against a mortgagor the relation is generally terminated when the mortgagee takes possession of the mortgaged premises, and from that time the statute begins to run."

In *McNair et al. v. Lot et al.*, 34 Mo. 285, 302, 84 Am. Dec. 78, it is said:

"Thus stands the law in cases directly between mortgagor and mortgagee, where it is seen the possession of the mortgagee with the bare omission to recognize the existence of the mortgage for the period of time which by the statute of limitations would be required to bar a legal title is a bar to the equity of redemption."

It is claimed that, as the sale under the trust deed to secure the New England Trust Company was void, O'Day's possession, and that of his

grantees with knowledge, must be held and treated as simply that of a mortgagee in possession under the \$7,500 mortgage. We think it clear, however, from the facts stated in the bill, that the possession of O'Day and his grantee was not that of a mortgagee. At the time of the sale plaintiff was present, and announced that the trust deed, under which the sale was being had, had been paid off, and that the sale would be invalid; but, notwithstanding this, O'Day purchased and went into possession, exercised acts of full and complete ownership, and conveyed the premises by deeds of warranty. Those claiming under him have exercised the same rights of ownership, have given deeds of trust to secure debts, and executed conveyances. True, plaintiff alleges that, knowing that O'Day was the holder of the \$7,500 deed of trust, he permitted him to take possession of the premises; but the reason which may have induced plaintiff to permit O'Day to obtain possession in no manner affects the character of O'Day's possession, as it is not alleged that he went into possession with any such understanding.

But one conclusion can be drawn from the facts, and that is that O'Day went into possession claiming absolute title under the sale made under the trust deed given to secure the New England Trust Company, and that he completely repudiated all interest of plaintiff in the premises. It is, however, said that, as the trust deed to O'Day to secure this \$7,500 did not mature until November 12, 1895, a cause of action to redeem did not accrue until that date, and, as this action was commenced November 11, 1905, the 10-year statute of limitations had not run against the right to redeem. If the possession of O'Day and those holding under him was by virtue of the \$7,500 mortgage executed November 12, 1890, there would be much force to this proposition; but they do not assert title or possession by virtue of that mortgage. Their claim to title and possession is clearly shown to be under and by virtue of the sale made in March, 1892, under the trust deed to secure the New England Trust Company, and plaintiff's cause of action to set aside and annul that sale accrued immediately. It is alleged in the bill:

"That plaintiff never learned until more than 13 years after said pretended sale that the trustee in the said deed of trust to the New England Trust Company had never been called upon to act as trustee, and advertise and make sale of the said land under the provisions of said deed of trust."

It is argued that for that reason the statute did not begin to run until after such discovery. Such an allegation is insufficient. *Redd v. Brun*, 157 Fed. 190, 84 C. C. A. 638; *Wood v. Carpenter*, 101 U. S. 135, 140, 25 L. Ed. 807; *National Bank v. Carpenter*, 101 U. S. 567, 25 L. Ed. 815. The mere ignorance of the plaintiff of his cause of action will not prevent the running of the statute. There must be some concealment of facts which ordinary diligence could not discover. In this case none are pleaded. Plaintiff knew of the substitution of a trustee, and we cannot presume that, had he made inquiry, he would not have ascertained the truth in respect to whether Leavens as trustee had refused to act. Plaintiff did know, however, that the deed of trust had been fully paid, and that the sale was unauthorized

and void, as announced by him at the time of the sale. He thus at that time had knowledge of facts constituting his cause of action. Plaintiff's claim that his failure to redeem from that sale was because of financial inability to do so is not availing. *Hayward v. National Bank*, 96 U. S. 611, 618, 24 L. Ed. 855; *Washington v. Opie*, 145 U. S. 214, 12 Sup. Ct. 822, 36 L. Ed. 680; *Leggett v. Standard Oil Co.*, 149 U. S. 287, 13 Sup. Ct. 902, 37 L. Ed. 737.

We think it clear that the demurrers to the bill were properly sustained, and the decree is affirmed.

LEW MOY v. UNITED STATES.

(Circuit Court of Appeals, Ninth Circuit. October 5, 1908.)

No. 1,536.

APPEAL AND ERROR—REVIEW.

Findings of a District Court adverse to the right of a Chinese person to remain in the United States, on his claim of citizenship, cannot be reviewed on a writ of error, where the evidence was not made part of the record by a bill of exceptions.

[Ed. Note.—For cases in point, see Cent. Dig. vol. 3, Appeal and Error, §§ 2433, 2434.]

In Error to the District Court of the United States for the Southern District of California.

Henry C. & Oliver Dubble and George L. McKeeby, for plaintiff in error.

Oscar Lawler, U. S. Atty., and A. I. McCormick, Asst. U. S. Atty. Before GILBERT, ROSS, and MORROW, Circuit Judges.

MORROW, Circuit Judge. The plaintiff in error was arrested in Los Angeles, Cal., upon a warrant issued by the United States commissioner, based upon a complaint charging the defendant with being unlawfully within the United States, contrary to the provisions of the Chinese restriction acts. It appears that upon the hearing before the commissioner the defendant was represented by counsel, who refused to offer any evidence in his behalf, contending that the defendant was a native-born citizen, and that the burden of proof was upon the United States to show that the defendant was unlawfully in the United States. The commissioner found, upon examination before him, that the defendant was by race, language, color, and dress a Chinese person and a laborer by occupation; that he had failed to establish by affirmative proof to the satisfaction of the commissioner his lawful right to remain in the United States; that he had not made it appear that he was a subject or citizen of any other country than China; and thereupon the commissioner found and adjudged that the defendant was unlawfully within the United States, and that he should be removed and deported from the United States. An appeal was taken to the United States District Court at Los Angeles. It appears from the minutes of the court that, after the denial by the court of a motion

of the United States Attorney to dismiss the appeal, the case was heard de novo. Upon this hearing the depositions of two Chinese witnesses for the defendant, taken before the United States commissioner in San Francisco, were read to the court. The District Court, after hearing this and other testimony, affirmed the findings, order, and judgment of the commissioner, and ordered the deportation of the defendant. The case is brought to this court upon writ of error.

The counsel who appeared for the defendant in this court, being familiar with the practice and the decisions of the courts in these cases, conceded that the points of law and objections urged on behalf of the defendant before the commissioner and in the District Court, as well as the assignments of error on this application for review, were untenable. He, however, contends that the judgment of the District Court should be reversed, and the defendant discharged, on the ground that the two Chinese witnesses whose depositions were read to the court testified that the defendant was born in San Francisco, and that this testimony stands uncontradicted. But this testimony does not appear in the bill of exceptions. The bill contains the evidence in the District Court offered by the United States, to the effect that the defendant was found at work in a hotel kitchen in Los Angeles; that he spoke Chinese, and but very little English; that he presented no certificate of residence showing, or tending to show, his right to remain in the United States; and it was admitted that the defendant was a person of Chinese descent. The bill shows that counsel for the defendant thereupon moved the court for an order dismissing the case and discharging the defendant, upon the ground that the United States had failed to make out a case. This motion being denied, the bill contains the following statement:

"The defendant then introduced evidence to prove his nativity, and the plaintiff thereafter introduced evidence, both oral and documentary, in rebuttal."

What this evidence was does not appear; but the certificate of the court, referring to this evidence, is as follows:

"The foregoing is a statement of the proof made and evidence adduced at, and proceedings had upon, the hearing and trial of this action before me."

The findings of the District Court are:

"(1) That the said defendant, Lew Moy, is a Chinese person, and a person of Chinese descent, and a laborer by occupation.

"(2) That said defendant, Lew Moy, has failed to establish by affirmative proof to the satisfaction of said court, or the judge thereof, his lawful right to be or remain in the United States.

"(3) That the said defendant, Lew Moy, has not made it appear to the said court, or to the judge thereof, that he is a subject or citizen of any other country than China."

These findings are conclusive. The testimony of the two Chinese witnesses relied upon by plaintiff in error was not made a part of the record by the bill of exceptions, and cannot be considered. *Suydam v. Williamson*, 20 How. 427, 433, 15 L. Ed. 978; *England v. Gebhardt*, 112 U. S. 502, 505, 5 Sup. Ct. 287, 28 L. Ed. 811; *Duncan v. Atchison, T. & S. F. R. Co.*, 72 Fed. 808, 812, 19 C. C. A. 202. The fact

that the depositions are in the transcript does not make them part of the record on writ of error. *Suydam v. Williamson*, supra; *Duncan v. Atchison, T. & S. F. R. Co.*, supra. But, if they be deemed a part of the record, the sufficiency of the evidence to justify the findings cannot be reviewed upon this writ of error. The certificate of the court is that, after the defendant had introduced evidence to prove his nativity, the plaintiff (the United States) introduced evidence, both oral and documentary, in rebuttal. The presumption is that this evidence in rebuttal was sufficient to justify the findings.

The judgment and order of the District Court is affirmed.

UNITED STATES v. NEW YORK CENT. & H. R. R. CO. et al.
(Circuit Court of Appeals, Second Circuit. June 25, 1908.)

No. 218.

1. COURTS — REVIEWABLE ORDERS — ORDER ABATING JUDGMENT IN CRIMINAL CASE.

A motion by the executrix of a person deceased to abate a judgment entered against him in a criminal action in his lifetime, because of his death after it was entered, is an independent proceeding of a civil nature, and the order or judgment therein may be reviewed on error by the United States.

[Ed. Note.—Orders decrees and judgments reviewable in Circuit Court of Appeals, see note to *Salmon v. Mills*, 13 C. C. A. 374.]

2. CRIMINAL LAW — JUDGMENT — DECLARING JUDGMENT ABATED — POWER OF COURT AFTER TERM.

After the expiration of the term at which a judgment was rendered against a defendant in a criminal case the court has no power by an order to declare such judgment abated because of the subsequent death of the defendant.

Ward, Circuit Judge, dissenting.

In Error to the Circuit Court of the United States for the Southern District of New York.

For opinion below, see 152 Fed. 279.

See, also, 146 Fed. 298.

Henry L. Stimson, U. S. Atty. (Felix Frankfurter, Asst. U. S. Atty., of counsel), for the United States.

Austen G. Fox and John D. Linsay, for defendant in error.

Before LACOMBE, WARD, and NOYES, Circuit Judges.

NOYES, Circuit Judge. In May, 1906, Fred L. Pomeroy, an officer of the New York Central & Hudson River Railroad Company, was indicted in the Circuit Court for offering, granting, and giving a rebate in violation of the so-called "Elkins Act." Act Feb. 19, 1903, c. 708, 32 Stat. 847 (U. S. Comp. St. Supp. 1907, p. 880). At the October term, 1906, for the trial of criminal causes, he was tried, convicted, and fined \$6,000; the judgment being docketed at the time. Afterwards he died. In March, 1907, and after the final adjournment of the October term, the Circuit Court, upon the application of de-

pendant in error, as executrix of the will of said Pomeroy, entered an order declaring said judgment to have abated and to be no longer of any validity. The United States has taken the present writ to review such order.

At the outset the defendant contends that the government has no right to proceed in this way; that a writ of error can be sued out by the United States in a criminal case only to the Supreme Court, and to that court only in particular instances. The right of the government may be so limited in criminal cases. But this is not a criminal case. The issue in the criminal proceedings was the guilt of the accused. That issue had been determined before these proceedings were instituted. Indeed, the very occasion for these proceedings was the closing of the criminal case by the rendition of the judgment. Instead of being criminal in their nature, these proceedings constitute, in effect, a civil suit by the representative of Mr. Pomeroy's estate to relieve it from the payment of the judgment, for a cause wholly apart from the question of his guilt or innocence. The contention that the United States has no standing to prosecute this writ is, therefore, not well founded.

The order declares the judgment of no validity. But when it was entered the court had lost control of the judgment. It was a final judgment, and the term at which it was rendered had expired before any steps were taken. The court had no power to make the order, and its action in making it was erroneous. *Phillips v. Negley*, 117 U. S. 665, 6 Sup. Ct. 901, 29 L. Ed. 1013; *Bronson v. Schulten*, 104 U. S. 410, 26 L. Ed. 797; *United States v. 1,621 Pounds of Fur Clippings*, 106 Fed. 161, 45 C. C. A. 263.

We are asked to determine whether the death of Mr. Pomeroy operated to vacate the judgment. But the question does not arise. If the death in itself vacated the judgment, the order was unnecessary. If it did not have that effect, the order was necessary, provided the court had had power to make it. But, necessary or unnecessary, the order was erroneous, because it affected a judgment over which the court had no control.

The order is reversed.

WARD, Circuit Judge (dissenting). If the motion of the executrix of Frederick L. Pomeroy, deceased, to abate the judgment entered against him in a criminal action in his lifetime, because of his death after it was entered, is to be regarded as an independent proceeding of a civil nature to which the United States has a right of appeal, I think it will be necessary to consider whether the Circuit Judge was right or wrong in holding the judgment to be abated. Such decisions as *Bronson v. Schulten*, 104 U. S. 410, 26 L. Ed. 797, and *Phillips v. Negley*, 117 U. S. 665, 6 Sup. Ct. 901, 29 L. Ed. 1013, only decide that after the expiration of the term, without extension by order, the court is powerless to amend or vacate its judgment as wrongfully entered, because containing error either of law or fact. This motion does not impeach the judgment on such grounds, but merely sets up a fact, occurring subsequently to its entry, which it is alleged as a matter

of law abates it, though rightfully obtained, and containing no error of law or fact. I think the court has as much power to do this at any time as it would have to require the plaintiff to satisfy the judgment if the executrix had actually paid it after the term had passed.

For this reason, I dissent from the opinion of the court, which reverses the order on the ground that the court had no power to make it.

In re GOLDEN MALT CREAM CO.

NATIONAL CHEMICAL CO. et al. v. GOLDEN MALT CREAM CO.

(Circuit Court of Appeals, Seventh Circuit. July 22, 1908.)

No. 1,418.

BANKRUPTCY — ACTS OF BANKRUPTCY — APPOINTMENT OF RECEIVER — "INSOLVENCY."

The word "insolvency," as used throughout Bankr. Act July 1, 1898, c. 541. 30 Stat. 544 (U. S. Comp. St. 1901, p. 3418), means insolvency as defined in such act; and an order of a state court appointing a receiver for a corporation on a petition charging insolvency does not constitute an act of bankruptcy, under section 3a (4), as amended by Act Feb. 5, 1903, c. 487, § 2, 32 Stat. 797 (U. S. Comp. St. Supp. 1907, p. 1025), where the term is there used to define a different state of facts, and by an amendment of the order of the state court made after the filing of the petition in bankruptcy it appears that it was not made on a finding of insolvency within the meaning of the bankruptcy act.

[Ed. Note.—For other definitions, see Words and Phrases, vol. 4, pp. 3647-3655; vol. 8, p. 7689.]

Petition for Revision of Proceedings of the District Court of the United States for the District of Indiana.

The respondent, the Golden Malt Cream Company, is an Indiana corporation, engaged in manufacturing and trading in drugs and chemical compounds. October 4th, 1906, one Charles A. Loring, a stockholder and the secretary of petitioner, appearing by one John A. Hibbard, also a stockholder and the president of the company, in a bill in the St. Joseph County Circuit Court of Indiana, praying for the appointment of a receiver to take charge of the property of respondent, and make distribution thereof, alleged:

"That the total assets of said corporation are of the probable value of \$35,000.00. This plaintiff alleges that he is a stockholder of said defendant corporation and that said defendant corporation is insolvent and has not now moneys, means, property or assets with and out of which to pay its existing indebtedness; that it is indebted to numerous and divers persons in the aggregate amount of \$25,000.00; that a large portion of such indebtedness is past due and said defendant corporation has not now the money and assets to meet its obligations or to pay its overdue indebtedness, and that certain of the creditors of said corporation are threatening to bring suits against the corporation to recover judgment on the debts due them, thereby creating a preference in their favor as against the other creditors of said corporation to the prejudice of their rights and to the rights of the stockholders.

"Petitioner further alleges that the business of said corporation as now conducted is being conducted at a loss and that if continued the said defendant corporation will become and be wholly insolvent and the assets thereof will be wholly insufficient to pay its indebtedness and nothing whatever will be left for the stockholders of said corporation."

On the same day, by unverified answer, the respondent admitted that the indebtedness was nearly twenty-four thousand dollars; that a large portion of the same was past due; and that it had no available means at hand with

which to meet the same; and upon the complaint and answer thus filed, and upon the same day, also, the following order was entered:

"That this defendant admits the allegations of said petition to be true except as to the allegations of insolvency and as to the amounts owing by this defendant to the plaintiff and other parties as set forth in said petition.

"That the business of this defendant has been and is now being conducted at a loss and if continued as it is now conducted the indebtedness incident thereto, which will be incurred by this corporation, will be greatly in excess of its means with which to pay and in excess of its property and assets.

"That this defendant corporation is indebted to various persons and firms, amounting in the aggregate to nearly \$24,000.00; that a large portion of such indebtedness is past due and defendant has no available means at hand with which to meet the same and certain of its creditors are threatening to institute suits and recover judgment against the corporation, to issue and levy executions upon its property thereby creating a preference in their favor and preventing this defendant from filling certain orders now on hand for finished product and preventing this defendant from converting certain raw material on hand into finished product and disposing of same at a profit."

December 4, 1906, the petitioners filed their petition in the United States District Court, and January 29th, 1907, an amended petition, asking that respondent be declared a bankrupt under section 3, par. "a," subd. 4, of the Bankruptcy Act of July 1, 1898, c. 541, 30 Stat. 546 (U. S. Comp. St. 1901, p. 3422), to which petition as amended, the respondent filed an answer denying insolvency and the other allegations of the petition.

December 10th, 1906, the respondent filed a petition in the St. Joseph Circuit Court, asking for a new trial in the cause in which the receiver had been appointed. A new trial having been granted, a new petition was filed that omitted the averment that the respondent was insolvent, but (conforming to a statute of the state) asked for the appointment of a receiver on an averment that the company was in danger of becoming insolvent; and to this petition an answer was filed consenting to the appointment of a receiver on the ground named, but denying insolvency. And upon this petition and answer, a receiver was appointed.

Such proceedings were then had in the United States District Court that a special master eventually submitted a finding that notwithstanding these later proceedings in the State Court, respondent was estopped by the recitals of insolvency contained in the record of the State Court of October 4th, 1906, to deny its insolvency at the time the petition was filed in the United States District Court. To this finding, as a conclusion of law, proper exceptions were filed and sustained, and the matter was referred back to the master to take testimony upon the issues of fact joined. It is to revise and reverse the order of the court sustaining the exceptions to this conclusion of law, that this petition is brought to this court.

Russell B. Harrison, M. L. Clawson, and Oscar M. Fritz, for petitioners.

John L. Sinkes, for respondent.

Before GROSSCUP, BAKER, and SEAMAN, Circuit Judges.

GROSSCUP, Circuit Judge (after stating the facts as above). The question of law presented is, whether or not respondent is estopped by reason of the proceedings in the State Court, October 4th, 1906, notwithstanding the subsequent proceeding, from denying that it is insolvent within the meaning of the Bankruptcy Act—the actual facts relating to insolvency being, that the company had assets approximately of thirty-five thousand dollars and debts of twenty-four thousand dollars; facts that standing apart from the State Court recitals, do not render the company insolvent within the meaning of the Bankruptcy Act.

Section 3, par. "a," subd. 4, of the Bankruptcy Act of July 1, 1898, c. 541, 30 Stat. 546 (U. S. Comp. St. 1901, p. 3422), provides that it shall be an act of bankruptcy when because of insolvency, a receiver or trustee has been put in charge of his property under the laws of a state; from which it is argued by petitioners that the act of bankruptcy does not depend upon the actual status of insolvency, as that status is fixed by the Bankruptcy Act, but upon the fact that a finding of insolvency is disclosed in the record of the State Court upon the basis of which a receiver was appointed; and that such finding cannot, after bankruptcy proceedings are begun, be recalled.

We cannot concur in this view of the law. The word "insolvency," as used in the Bankruptcy Act, means insolvency within the meaning of the definition of that act. And though the same word be employed in the finding of a State Court to define a set of facts different from the facts intended to be defined by the word in the Bankruptcy Act, the State Court is not without power, by appropriate amendment, to so change its order that such order will set forth the real facts on which the order was intended to act; for certainly a mere divergence of definition ought not to have the effect of making that an act of bankruptcy which in fact was not intended by the bankruptcy law to be an act of bankruptcy.

The petition is denied, and the order of the United States District Court of Indiana to reverse and revise which the petition is filed, is Affirmed.



HILLS, Clerk of District Court, v. VALENTINE.

(Circuit Court of Appeals, Ninth Circuit. October 5, 1908.)

No. 1,545.

CLERKS OF COURT—ACTION AGAINST—MONEY RECEIVED IN OFFICIAL CAPACITY.

An action will not lie against the clerk of a federal court in his official capacity to recover money received by him in such capacity and which passed into the registry of the court, since such money can only be paid out under authority of the government by its officers and agents in the manner prescribed by statute.

[Ed. Note.—For cases in point, see Cent. Dig. vol. 10, Clerks of Courts, § 117.]

In Error to the District Court of the United States for Division No. 1 of the District of Alaska.

J. A. Hellenthal, Shackelford & Lyons, and Lorenzo S. B. Sawyer, for plaintiff in error.

J. H. Cobb, for defendant in error.

Before GILBERT, ROSS, and MORROW, Circuit Judges.

ROSS, Circuit Judge. This was an action at law, brought by the defendant in error in the court below against the plaintiff in error, "as clerk of the United States District Court for Alaska, Division No. 1," to recover the sum of \$500, with interest thereon from May

21, 1901; the complaint alleging the official character of the defendant, and as a cause of action that:

"On the 21st day of May, 1901, there was in the care and custody of the defendant, as such clerk, the sum of \$1,099.70 belonging to the plaintiff, which money had been paid to defendant as such clerk in the case of E. R. Peoples, as Administrator of the Estate of E. G. De Norton, Plaintiff, v. Emery Valentine and J. G. Cosslett, Defendants, and which money plaintiff was then and there entitled to demand and receive of the defendant, and ever since has been, and now is, entitled to demand and receive the same."

The complaint further alleged that on May 21, 1901, the defendant appropriated and converted the sum of \$500 of that money to his own use and benefit, and has ever since retained the same to his own use, and refuses to pay any part of it to the plaintiff, after demand made therefor. The complaint also contained the allegation:

"That, if the defendant ever executed a bond as such clerk, he failed and neglected to record the same in the clerk's office of this court, and there is no data in said office whereby this action can be brought upon the bond of the defendant as clerk, if any such bond was ever given."

The judgment entered in the case by the court below is:

"That the plaintiff, Emery Valentine, do have and recover of and from the defendant, W. J. Hills, as clerk of the District Court for Alaska, Division No. 1, the sum of six hundred and ninety-two and $\frac{68}{100}$ (\$692.66) dollars, with interest thereon from the 15th day of March, 1906, at the rate of 8 per cent. per annum, and all costs and disbursements herein incurred, taxed at _____ dollars, for all of which let execution issue."

If the defendant had been in fact clerk of the court below at the time of the commencement of the action, the court would have had no jurisdiction of the suit; for money that passes into the registry of the court can be legally paid out only under the authority of the government by its officers and agents, in the manner prescribed by statute and the rules and regulations made in pursuance thereof. But the record in the case shows that the defendant was not clerk of the court at the time of the commencement of the action, and at no time since has been such clerk. The allegation of the complaint concerning his official capacity may therefore be treated as surplusage (*Hardy v. Call*, 16 Mass. 530), and the like official designation of the defendant may be stricken from the judgment.

As the record clearly shows that the defendant appropriated to his own use the money to which the plaintiff was entitled, the case is remanded to the court below, with instructions to strike from the judgment the erroneous official designation of the defendant, and, as so modified, it will stand affirmed.

HONG YON et al. v. UNITED STATES.

JIN DUN et al. v. SAME.

(Circuit Court of Appeals, Second Circuit, June 3, 1908.)

Nos. 266, 267.

ALIENS—CHINESE EXCLUSION ACT—REVIEW OF FINDING OF COMMISSIONER.

It is the settled general rule that the finding of a commissioner, who sees and hears Chinese witnesses sworn in behalf of Chinese persons of the prohibited class seeking entry to the United States, and who reaches the deliberate conclusion that they are not entitled to credit, will not be reversed by an appellate court.

[Ed. Note.—Citizenship of Chinese, see notes to *Gee Fook Sing v. United States*, 1 C. C. A. 212; *Lee Sing Far v. United States*, 35 C. C. A. 332.]

Appeal from the District Court of the United States for the Northern District of New York.

On appeals from orders of the District Court for the Northern District of New York affirming orders for the deportation of the appellants made by a United States commissioner.

R. M. Moore, for appellants.

Harry E. Owen, for appellee.

Before COXE, WARD, and NOYES, Circuit Judges.

COXE, Circuit Judge. The questions in controversy are substantially identical in each of the above-entitled actions.

The defendants are Chinese persons, not members of the exempt class, who came into the United States from Canada. The question presented to the commissioner was whether they were born in the United States and were, therefore, citizens. In each case a single Chinese witness was called who testified in substance that he was the uncle of the respective defendants and that he was born in California. The witness was examined and cross-examined at considerable length. His testimony did not satisfy the commissioner that the fact of citizenship had been established; in other words, he did not believe the witness.

In the second of the above-entitled actions the commissioner gives his reasons for thinking that the story of the witness was fabricated and in both actions he states that he cannot conscientiously say that the defendants have proven to his satisfaction that they were born in this country. The District Judge, on review, reached the same conclusion.

The law is now well settled that the finding of the commissioner, who sees and hears the witnesses and who reaches the deliberate conclusion that they are not entitled to credit, should not be reversed by an appellate court. *Chin Bak Kan v. United States*, 186 U. S. 193, 200, 22 Sup. Ct. 891, 46 L. Ed. 1121; *Quock Ting v. United States*, 140 U. S. 417, 11 Sup. Ct. 733, 851, 35 L. Ed. 501; *Ark Foo and Hoo Fong v. United States*, 128 Fed. 697, 63 C. C. A. 249; *Lee Sing Far v. United States*, 94 Fed. 834, 35 C. C. A. 327. There are exceptions to this rule but they are inapplicable to the cases at bar.

The decisions should be affirmed.

MORSE CHAIN CO. v. LINK BELT MACHINERY CO.

(Circuit Court of Appeals, Seventh Circuit. April 14, 1908. Rehearing Denied May 22, 1908.)

Nos. 1,431, 1,432.

PATENTS—INFRINGEMENT—DRIVE CHAINS.

The Morse patents, No. 736,999 and No. 757,762, for improvements in chain driving gear and drive chains, construed, and *held* not infringed.

Appeal from the Circuit Court of the United States for the Eastern Division of the Northern District of Illinois.

These are separate appeals, the one being from a decree dismissing for want of equity a bill to enjoin appellee from infringing letters patent No. 757,762, granted to the Morse Chain Company, assignee of Everett F. Morse, April 19th, 1904, for improvement in drive chains—the finding of the bill being that appellee did not infringe the patent in suit; and the other being from a decree dismissing for want of equity a bill to restrain appellee from infringing letters patent No. 736,999, granted to the Morse Chain Company, assignee of Everett F. Morse, August 25th, 1903, for improvements in chain driving gear, the finding of this decree also being that appellee had not infringed.

The following are the claims relied upon in the suit upon patent No. 757,762:

"1. A drive-chain having its links composed of a plurality of plates, the plates of each link being interspersed upon the pintles with the plates of the adjacent links, and pintles formed in separate parts, of which one part engages with the plates of one link only and bears upon the other part of the pintle.

"2. A drive-chain having each link composed of a plurality of plates, the plates of each link being interspersed upon the pintles with the plates of the adjacent links, and pintles formed in separate parts adapted to turn one upon the other, the apertures in said plates through which both parts of the pintles pass being made to hold in place one part of each pintle and to allow free movement or clearance of the other part thereof."

"9. A drive-chain having adjacent links composed of a plurality of plates adapted to arch over the sprocket-teeth, the plates of each link being interspersed upon the pintles with the plates of the adjacent links, and pintles formed in two parts, of which one part engaged with the plates of one link only and passes freely through openings in the plates of the adjacent link, and the other part engages with the plates of said adjacent link and passes freely through openings in the plates of the first-mentioned link.

"10. A drive-chain having adjacent links composed of a plurality of plates adapted to arch over the sprocket-teeth, the plates of each link being interspersed upon the pintles with the plates of the adjacent links, and pintles formed in separate parts which bear upon each other throughout substantially the full width of the chain, one part of the pintle engaging with the plates of one link only and passing freely through openings in the plates of the adjacent links.

"11. A drive-chain having each link composed of a plurality of plates interspersed upon the pintles with the plates of the adjacent links, and pintles formed in separate parts extending substantially the full width of the chain, and adapted to turn one upon another, the apertures in said plates being made to rigidly hold one part of each pintle and to allow free movement of the other part thereof."

The following are the claims relied upon in the suit upon patent No. 736,999:

"1. In a rocker-joint for chains or other devices, the combination with one of the hinged parts provided with an aperture and having a bearing-surface, of the other hinged part also provided with an aperture, and having a

bearing-surface and a member having a double rocking-surface located in said apertures between said bearing-surfaces and adapted to rock on either of them.

"2. In a rocker-joint for chains or other devices, the combination of one of the hinged parts having an aperture therein and provided with a bearing-surface, of a pintle passing through said aperture and having a bearing-surface, and a member having a double rocking-surface located in the aperture between said bearing-surfaces."

"6. A rocker-joint for chain or other devices consisting of two pieces associated together within the parts connected thereby, and having opposing bearing-surfaces and a member between said surfaces upon which either may rock.

"7. In a joint for chains or other devices having parts hinged together, a pintle consisting of two members connected to the respective parts so hinged, and a third member adapted to co-operate with either one of them to form a rocking-surface for the other."

Paul Synnesvedt and Charles C. Linthicum, for appellant.
Charles Howson, for appellee.

Before GROSSCUP, BAKER, and SEAMAN, Circuit Judges.

GROSSCUP, Circuit Judge (after stating the facts as above). In his opinion the Circuit Judge, deciding this case below, said:

"Patent No. 757,762, covers a two-part pintle in combination with a plurality of plates in each link interspersed upon the pintles with the plates of the adjacent links, each plate having an aperture which is so formed as to hold one part of the pintle and allow free clearance of the other, one part of the pintle engaging with the plates of one link only and bearing upon the other part of the pintle. These pintle parts are made to move one upon the other freely, for which purpose the openings in the plates are provided with clearance room. Patent No. 736,999 calls for a pintle device differing from No. 757,762 mainly in that it describes a three-part pintle instead of a two-part pintle. Defendant's device substantially follows patents granted to J. M. Dodge, May 24, 1904, and subsequent to that date and shows a combination of the multiple links with a plain old style pintle and two segmental bushing plates arranged with clearance room in order to provide free sliding or hinge movement of the bushings, which move with their several links, the plates of which bear upon the bushing, and not upon the round pintle. Thus, the friction occurs between the pintle and bushing and not between the link plates and pintle. Defendant insists the bushings are a part of the several links. This would be equally true of complainant's three-part pintle.

"The link chain belt was very old in the art at the time Morse filed the application for the patents in suit, and it was mainly to avoid the wear between the links and the pintles that he devised the joint in question. The wear of the links upon the pintle resulted in lengthening the belt, whereby it failed to engage accurately with the teeth of the sprocket wheel for which it was mainly employed, causing undue friction and ultimate ruin of the wheel or chain or both. In the case of the three-part pintle joint, Morse sought to overcome this by arranging the parts of the pintle so that the two outside members of the pintle would rock upon the middle member. Complainant now seeks to give this patent a construction which shall include hinge or sliding movement of the three parts of the pintle, whereas Morse's action in the patent office changing the terms of the claims, taken together with the reading of the patent in all its phases as granted, utterly exclude any idea other than that the actions of the pintle parts is limited to an arrangement thereof which secures a rocking or rolling co-action thereof, in contra-distinction to a sliding or hinge action."

And again speaking of patent No. 757,762,—

"From the record it appears, that at the time the application for the two-part pintle, Morse had it still in mind to limit its action to a rocking or rolling

motion, but that several years afterwards he added drawing numbered 20, as shown in the patent, disclosing a two-part pintle, one part of which slides back and forth upon the other, the two together making a cylindrical pintle, having clearance spaces. No reference is made in the claims to anything but a rocking or rolling joint, though some of the claims are silent as to the action of the pintle parts. The specifications in line 7, p. 2 read: 'Fig. 20 is a transverse section of the joint, showing a modified form of pintle'; in line 78, p. 2: 'Thus for each link the bearing-surface is doubled by the use of the two-part pintle and the wearing away at the pintle is thereby very materially decreased. This feature of my invention is equally applicable to a joint as shown in Fig. 20 formed of pintles so that one part of the pintle G' rubs on or turns in the other part F', as the joint bends.' Under the circumstances, it may be doubted whether the patent covers the device of drawing Fig. 20. However that may be, it is certain that this patent is limited to a two-part pintle, for although in line 8, p. 1, the patentee says: 'This invention relates to improvement in drive chains for general power transmission, and particularly to chains of this class wherein the pintle consists of two parts bearing upon one another,' etc., yet he nowhere claims or describes anything but a two-part pintle."

It is earnestly insisted, however, that whereas in all the other claims of patent No. 757,762, the description is as of a two part pintle, in claim ten there is no such limitation, the description being "and pintles formed in separate parts"; the argument being that such description covers a three part pintle, as well as a two part pintle. But the fact remains, that the specific thing described in the patent is not a three part pintle, but is a two part pintle, and there is nothing in the descriptive portion of the patent indicating that anything else than a two part pintle, either actually or potentially, was in the mind of the inventor.

It is also earnestly insisted that though patent No. 757,762 was applied for more than two years after patent No. 736,999, and was allowed almost eight months afterwards, it constitutes the generic patent—No. 736,999 being for a specific invention only. In this view we cannot concur. This is not a case in which a patentee, having first made application for a patent for a generic invention, has subsequently applied for patents for specific improvements. This is a case in which a patentee, possessed of an alleged generic idea, elected to first apply for a patent for a specific embodiment embracing the essential feature of the generic idea, "the extended bearing," and later specifying such essential feature in another specific embodiment, claims that the generic idea growing out of such essential feature, belongs to the later, and not to the earlier, patent. To allow this, it seems to us would be to make the second patent overlap the first, a result that involves the patentee in this dilemma, either that his second patent is not generic in the respect named, or that it is a double patenting.

On the whole case, we are content to find that the appellee's device is not an infringement of the patents sued upon, and that therefore, the decree appealed from should be affirmed.

In re MEAKINS.

(District Court, E. D. Washington, E. D. September 4, 1908.)

No. 5.

ALIENS—NATURALIZATION—QUALIFICATIONS FOR CITIZENSHIP.

The right to become a citizen is a privilege to which an alien is not entitled regardless of qualifications, and an applicant who has no knowledge whatever of the Constitution, or even of its existence, of the organization of the government, or the manner of the enactment or enforcement of its laws, and who, instead of availing himself of time given to obtain general information on such subjects, assumes a defiant attitude toward the court and insists on his admission as a matter of right, cannot be said to be attached to the principles of the Constitution or well disposed to the good order of the country, and is not entitled to admission as a citizen.

[Ed. Note.—For cases in point, see Cent. Dig. vol. 2, Aliens, § 123.]

Petition for Naturalization.

A. G. Avery, U. S. Atty.

WHITSON, District Judge. This matter arises upon the petition of Joseph Meakins to become a citizen of the United States. At the time fixed for the hearing, pursuant to notice duly given, the petitioner appeared with his witnesses. Upon examination his moral character and residence were established by competent proof. As to the existence of the Constitution of the United States, the reason for its adoption, the organization of the government, the causes which led to it, the methods provided for the enactment and enforcement of the laws, and the rights, prerogatives, and duties of citizenship, he did not have the slightest conception. In this state of the case the matter was continued to enable him, in a measure at least, to familiarize himself with our institutions. Now, upon his return for further examination, it is shown that he is utterly wanting in knowledge of those things which every citizen ought to possess. Accordingly he has been advised to devote himself to further study, accompanied by the suggestion that the hearing be again continued to the end that he may meet the requirements. The petitioner, instead of accepting this proffer made for his benefit, in a dictatorial manner takes direct issue with the court and stoutly asserts that he is qualified and that he is sufficiently advised, notwithstanding its finding to the contrary.

One not represented by counsel, as in applications of this character, should not be denied the fullest opportunity to establish without formality the facts necessarily in issue; but unexpectedly this applicant has not met the court in that spirit of accommodation, twice extended, which might be looked for under the circumstances. While it may not be impossible for one to be attached to the principles of the Constitution of the United States who is without definite knowledge of the workings of the government in detail, he must have sufficient general information concerning it as to enable him to give a reason for his faith; and where, as in this case, an applicant does not know how the laws are made, who makes them, nor how they are enforced, he is illy prepared to participate in the selection of the persons who shall

perform those duties. He cannot be attached to principles of which he is entirely ignorant. His disposition, manifested in open court, also shows that he is not well-disposed to the good order and happiness of the country. He appears in an attitude of defiance, as one who is entitled to demand admission, regardless of qualifications. Without any understanding of the nature of the duties which would devolve upon him as a citizen, he meets the issue, not by insistent contention, as one appearing in his own behalf might have the right to indulge, but by arrogant assertion, thereby arraying himself against the authority which he would invoke, when he is so utterly unfit as to have no appreciation of his unpreparedness. The right to become a citizen is a privilege never hastily denied in this court, abundant opportunity being given to become familiar with those requisites essential to admission. But where an alien does not concur in the order of things as we have established them, at a time when so great a boon is being prayed for by him, it is perfectly manifest that he would hold his allegiance lightly, and would continue to refuse obedience and acquiescence, should the elective franchise be conferred upon him. Such a one must not only be qualified, but must meet us at the threshold with a disposition to obey the laws, and with proper respect for the tribunals charged with their enforcement.

Petition dismissed.

In re SCHNEIDER.

(Circuit Court, S. D. New York. October 2, 1908.)

1. ALIENS—NATURALIZATION—"RESIDED CONTINUOUSLY."

In Naturalization Act June 29, 1906, c. 3592, § 4, subd. 4, 34 Stat. 596 (U. S. Comp. St. Supp. 1907, p. 422), which requires the court, before admitting an alien to citizenship, to be satisfied that he has "resided continuously" within the United States five years at least, and within the state or territory where the court is held one year at least," before his application, the word "continuously" is not used literally, as requiring the applicant to remain at all times physically within such jurisdictions, but applies to changes of domicile only; and a sailor, by going to sea, does not abandon his residence.

[Ed. Note.—Citizenship under state and federal laws, see note to *City of Minneapolis v. Rum*, 6 C. C. A. 37.]

2. SAME—WITNESSES—KNOWLEDGE OF RESIDENCE.

The knowledge of witnesses, who testify that an applicant for naturalization has been a resident of the United States and of the state for the length of time required by the statute, need only be such as is compatible with the applicant's employment; and, in case of a person who has been for a portion of the time in the navy, their testimony that he resided in a certain place before his enlistment, and returned there from time to time at the termination of his voyages and after his discharge, is sufficient.

Petition for Naturalization.

Max Schneider, in pro. per.

Henry L. Stimson, U. S. Atty.

WARD, Circuit Judge. The applicant arrived from Liverpool in the port of New York on or about November 1, 1902, and took up his

residence here. Subsequently he enlisted in the navy on board the United States ship *Wasp*, and while on board the *Wasp* took out his first papers December 26, 1905. He filed his petition for a certificate of citizenship June 3, 1908, which came on for final hearing October 1, 1908. He produced an honorable discharge for four years' service on the *Wasp*.

The applicant's mother is a servant in the house of one of the witnesses, who swears that he knew him from the day he landed; that after he enlisted in the navy he always came to see his mother when in port on shore leave, and constantly corresponded with her when at sea. The other witness testified that he knew the applicant for over five years, was with him when he took out his first papers, corresponded with him while in the navy, and saw him here several times when his vessel was in port.

Section 4, subd. 4, Act June 29, 1906, c. 3592, 34 Stat. 596 (U. S. Comp. St. Supp. 1907, p. 422), requires the court to be satisfied that the alien has resided continuously within the United States for at least five years, and within the state or territory where he applies for his certificate for one year, before the date of the filing of his petition, and that in addition to the oath of the applicant two citizen witnesses shall testify to the same things. A sailor, who has acquired a domicile, which is the sense in which the act uses the word "residence," does not abandon it by going to sea. This was the construction put upon a similar act (Act April 14, 1802, c. 28, § 1, 2 Stat. 153) in *Re An Alien*, Fed. Cas. No. 201a.

The word "continuously," which is not found in the act of 1802, cannot be construed literally; else a resident of New York would lose his right if he paid a visit to Europe at any time during the first four years of his residence, or spent a day in Jersey City within the year immediately preceding the day of filing his petition. The use of the word may be to prevent any intermediate change of domicile during the five years. If Congress had meant that the alien must remain actually within the territory of the United States uninterruptedly during the five years, it would have used language like that of Act March 3, 1813, c. 42, § 12, 2 Stat. 811:

"For the continued term of five years next preceding his admission as aforesaid have resided within the United States without being at any time during the said five years out of the territory of the United States."

The court is to be satisfied, not only by the testimony of the applicant, but by that of two witnesses in addition. It cannot be that the witnesses must see the applicant every day and every minute of every day for five years. Their knowledge must be appropriate to the applicant's employment. In the case of a sailor, if they know that he lived here before he went to sea, while at sea returned from time to time at the termination of his voyages, and corresponded with him, they know all that in the nature of his employment a sailor can supply.

I am satisfied in this case that the applicant did take up a domicile in the state of New York and resided there for five years before he filed his petition for a certificate of citizenship, and he is accordingly admitted.

INTERNATIONAL MERCANTILE MARINE CO. v. FELS et al.

(District Court, S. D. New York. June 6, 1908.)

1. EXPLOSIVES—EXPLOSION IN HOLD OF VESSEL—EVIDENCE AS TO CAUSE CONSIDERED.

Respondents shipped from Philadelphia to Liverpool about 75,000 pounds of "naphtha" soap contained in 1,000 boxes, each box containing 10 cartons, and each carton 10 cakes of soap, each wrapped in a piece of oil paper and of common paper. The soap contained from 6 to 9 per cent. of chemically free naphtha, which would slowly evaporate into the air. The shipment was stowed with other cargo in a hold having two four-inch ventilators; the hatch remaining closed during the voyage. The shipment was made in the summer, and the temperature of the hold was from 60 to 80 degrees Fahrenheit. On reaching Liverpool, the hatch was opened, and, after stevedores had gone into the hold, a violent explosion occurred, killing and injuring a number of men and doing a large amount of damage to the ship. It appeared that naphtha vapor, when mixed with air in the proportion of from 2 to 5 per cent., forms a highly explosive mixture when coming in contact with any igniting substance. *Held*, on the evidence, which disclosed the presence of no other explosive substance in the hold, that the explosion was caused by the vapor given off by the soap.

2. SAME—LOSS FROM DANGEROUS CARGO—LIABILITY OF SHIPPER TO CARRIER—NEGLIGENT STOWAGE.

Respondents at various times shipped in steamships of libelant's line consignments of "Fels Naphtha" soap, having such name on the boxes and all other packages. They had also previously notified libelant's agents that the soap contained naphtha, and that there might be danger of explosion if it were placed in a confined space, and had arranged that shipments should be stowed in a place where there was a free circulation of air. *Held*, that libelant was advised, both by the name and by such notice, of the character of the commodity, and of the necessity of properly handling it, the danger of an explosive mixture being formed by the air and naphtha vapor being a matter of common knowledge, and that, in stowing a shipment in a confined hold without proper ventilation, it assumed the risk, and could not hold respondents liable for the damages caused by an explosion resulting.

In Admiralty.

Robinson, Biddle & Benedict, for libelant.

Frank P. Prichard and Archibald Cox, for respondents.

ADAMS, District Judge. The International Mercantile Marine Company, the owner of the steamship Haverford, brought this action against Joseph Fels and Samuel S. Fels to recover the damages, which resulted from an explosion in the No. 3 hold of the said steamer as a result of vapor emitted from a shipment of 1,000 boxes of soap, weighing 90,000 pounds, for which a bill of lading was issued to the respondents containing, inter alia, the following clause:

"3. Also that shippers shall be liable for any loss or damage to steamer or cargo caused by inflammable, explosive or dangerous goods shipped without full disclosure of their nature, whether such shipper be principal or agent; and such goods may be thrown overboard or destroyed any time without compensation."

The libel further alleged that the said soap was manufactured by the respondents and known in the trade as Fels Naphtha soap and con-

tained a high percentage of chemically free naphtha and the explosion took place as a result of vapor emitted from the soap, in combination with the air coming in contact with fire or with a spark. It was further alleged that the said damages were not caused or contributed to in any way by the libellant, its agents, servants or employees, who had no knowledge or notice of the dangerous character of the said soap, but were caused solely by the negligence of the respondents, their agents, servants or employees as follows:

"1. In offering for carriage in an enclosed space on said Steamship soap manufactured by them containing a large amount of chemically free naphtha likely to be given off during the voyage and to make, with the air, a highly explosive combination.

2. In not informing your libellant of the dangerous character of said soap when it was offered for shipment.

3. In not informing your libellant of the precautions proper to be taken to prevent the occurrence of an explosion due to the composition of the said soap.

4. In not informing your libellant that the said soap emitted or was likely to emit a vapor which with a certain admixture of air, would make an inflammable compound liable to explode on coming in contact with fire or with a spark."

The libel further alleged that by reason of the explosion, damage was done to other cargo stowed in the steamer and she herself sustained serious damage, and that the libellant has been compelled to pay a considerable sum of money under the Workmen's Compensation Act of Great Britain in settlement of claims of its servants injured and killed, and the amount of the damage sustained by the libellant is the sum of \$100,000.

The answer denied that the soap contained a high percentage of chemically free naphtha, admitted the shipment and the explosion, denying, however, that the explosion was the result of vapor emitted from said soap in combination with air coming in contact with fire or with a spark. The answer denied the allegations of freedom from negligence on the libellant's part and of negligence on their part and alleged further:

"Respondents are manufacturers of a soap, which does contain as one of its ingredients, a small percentage of naphtha. This soap is named 'Fels Naphtha Soap,' and is so designated in conspicuous type on all interior and exterior wrappings and boxes, and the fact that it does contain naphtha is thus made publicly known to every one who handles it. Soap identical in all respects, including the amount of naphtha ingredient with the soap on the Haverford at the time of the explosion, has been manufactured by respondents for very many years prior to the filing of the libel in the present case, and has been sold in very large quantities and is a staple and well known article of commerce. It has been stored in warehouses and rooms, and shipped on cars and vessels in very large quantities, and under many different conditions of temperature and ventilation and had never been known to produce any vapor causing explosion. Said soap is not in fact inflammable, explosive or dangerous goods. The amount of said soap shipped upon the Steamship Haverford, was about seventy-five thousand pounds, and was not an unusual quantity to be shipped on a vessel, nor had respondents any notice that it was likely to be stored in a space not properly ventilated or not ventilated as a space in a ship should be to render that ship seaworthy for the transportation of such soap, or under conditions which would be likely to produce any unusual combination of air with naphtha. Said soap did not contain a large amount of chemically free naphtha, likely to be given off during the voyage and to make with the air a highly explosive combination. Respondents did make full disclosure to

libellant of the nature of the said merchandise, which at the time of said shipment was known to libellant, but the said merchandise was not inflammable, explosive or dangerous merchandise. So far as was known to respondents, there were no special precautions to be observed in the shipment and carriage of the said merchandise other than the proper ventilation of the compartments of a vessel in which are carried any substance containing a naphtha or similar ingredients. The said merchandise was not likely to emit a vapor, which with an admixture of air, would make an inflammable compound, liable to explode on coming in contact with fire, or with a spark. Nor had respondents any reason to suppose that fire or spark would be allowed in the compartment in which the soap had been stored. On the contrary, the fact that the goods had been for many years manufactured, stored and shipped without any such explosion, shows that it was not likely to cause such an explosion, and on information and belief, respondents aver that it did not cause the explosion in the present case. Respondents aver that the said explosion and any damage consequent thereon were not caused by the negligence of the respondents or either of them, their agents, servants or employees, and on information and belief respondents aver that the said explosion and the damage consequent thereon were caused solely by the negligence of the libellant, its agents, servants or employees."

The respondents then alleged that they had no knowledge of the remaining charges in the libel and required proof if they should be material.

The testimony shows that on or about June 2, 1906, the steamer sailed from Philadelphia to Liverpool; that prior to sailing there had been loaded in No. 3 lower hold a shipment of 1000 boxes of the respondents' soap, for which the above mentioned bill of lading was duly given. Each cake of soap was wrapped in a piece of oil paper, then a piece of ordinary wrapping paper upon which there was certain printed matter. Ten cakes of the soap were then placed in a carton, which was a heavy paper box with flaps at each end which were closed after the soap was put in. Ten of these cartons were then packed in a wooden box, 27⁷/₈ inches long, 14 inches wide and 7⁷/₈ inches high. Neither of the cartons nor the wooden box were air tight but would, together with the paper wrappings, retard the giving off of vapor by the soap. The gross weight of the shipment was about 75,000 pounds; the net weight of the soap being about 69,300 pounds. The soap was stowed in No. 3 lower hold. Forward of this hold, but separated from it by a steel bulkhead, was No. 2 lower hold. Just aft of No. 3 lower hold, but separated from it by a steel bulkhead, was No. 4 deep tank. On the deck above No. 3 lower hold was a refrigerating room but on this voyage nothing was in that room. The hatch to No. 3 hold was just forward of No. 4 deep tank, and its dimensions were about ten feet by twelve. There were two ventilators, about 4 inches in diameter, leading to No. 3 hold.

Besides the soap there were stowed in No. 3 hold barrels of lubricating oil and paraffin scale or wax and some oak staves. The oil barrels were stowed in the bottom of the hold all the way across the ship. Above these on the port side were stowed the boxes of soap, and on the starboard side were the paraffin or wax barrels. The staves were used as dunnage.

The cubical contents of No. 3 hold were 30,400 cubic feet. It was stowed about one-half full, so that the free air space was about 15,000 cubic feet. The boxes of soap occupied about 1,800 cubic feet.

The temperature of the air during the loading and the voyage was the ordinary summer temperature; that is, between 60° and 80°. The temperature of the water, was also the usual summer temperature, varying from 50° to 80°. The temperature of the hold at the time of the explosion was between 60° and 80°.

The hatches were on No. 3 hold during the voyage across. What ventilation it received was from the ventilators mentioned above and from such air as entered through the hatch openings, which were not sealed and admitted some air.

The steamer arrived in Liverpool June 13, 1906, but the hatches in No. 3 hold were not opened during that day. The next morning, about 7:20 o'clock, the stevedores removed the said hatches preparatory to discharging No. 3 hold. After the hatches were off the men went into the hold for the purpose of discharging the cargo therein. Very shortly afterwards, a very violent explosion occurred. Thirteen men were killed, a number were injured and a large amount of damage was done to the ship. The bulkhead between No. 2 and No. 3 holds was blown forward at the top about four feet. There was a large rent made in the bulkhead in the starboard corner and also one near the middle. The whole deck above was lifted and a large rent made in it near the starboard forward corner of No. 3 hold and extending some five feet into No. 2 hold. The cargo in both holds caught fire and this fire was with difficulty gotten under control.

The action was brought not only upon an alleged common law liability of the shippers but upon the contractual liability contained in the clause of the bill of lading quoted above, and the questions of fact to be determined are:

First. Was the explosion caused by vapor given off by the soap?

Second. Did the respondents make full disclosure to libellant of the nature of the soap or was it otherwise aware of it?

First. That the soap contained a quantity of naphtha is practically undisputed. It was variously estimated, after analyses of the soap, to have been from 6% to 9% of chemically free naphtha. The analyses so showed and there can be no doubt, I think, that notwithstanding the wrappings, the soap did give off a vapor, which, when mixed with air in proper proportions was highly explosive, upon being brought in contact with an igniting power, a flame for example, or a spark of high intensity.

It appears that the naphtha was the only commodity in the hold that was of an explosive nature, and in view of the explosion that took place, which was of such a character as might readily have been produced by naphtha, it does not seem that the fact of there being no definite proof of the manner of ignition, should prevent the only rational explanation of the explosion being adopted, without regard to the details.

The respondents urge, and their contention is supported by eminent experts, that the fumes of naphtha could not have caused such an explosion as took place, but the fact remains that the explosion did occur and that there is no other reasonable explanation of it save from the effects of the naphtha. I do not think that the attempted solution by testimony

of the probable presence of a high explosive, dynamite for example, is sufficient to overcome the actual presence of the naphtha and its explosive character. Not very persuasive testimony was given concerning the remains of an infernal machine found in the hold, but if such were there, which seems to be in some doubt, it is not enough to remove the plain explanation of the trouble from the naphtha.

It is sought by the respondents to show that there was too much ventilation in the hold to allow of the adoption of the libellant's theory of the naphtha cause; but while there was some ventilation there, it was evidently not sufficient to carry off all the vapor. The expert testimony shows that naphtha will only cause an explosion where the vapor is from 2% to 5% of the air. Above and below such a proportion, it will not explode, but burn quietly. The ventilation in this hold was doubtless sufficient to bring the quantity of vapor within the limits mentioned.

There has been a great deal of expert testimony with reference to the probable or possible ignition of the naphtha vapor but in considering it, we are, more or less, relegated to a realm of conjecture, which it is not necessary to explore. I think from the facts above stated, it is fairly to be concluded that the naphtha caused this explosion and requires an affirmative answer to the first question.

Second. It remains to be considered whether the respondents should be held liable for the results of the disaster.

This soap was first manufactured by the Stanton Manufacturing Company. The respondents commenced the sale of it in 1892, and its manufacture in 1894. Their shipments, storage and sales have been very extensive. They sold during their connection with it, and prior to June, 1906, between six hundred and seven hundred millions of cakes. It is shipped to all parts of the United States and to England. The output of their factory in Philadelphia is about fifteen carloads a day. At the time of the shipment on the *Haverford* it was neither a new article of manufacture or of marine shipment. It had been extensively sold and advertised and had been for many years shipped on lines of steamships, some of which at the time of the explosion were operated by the libellant.

The soap itself was not dangerous, inflammable or explosive. It contained, however, naphtha, which slowly evaporated into the atmosphere. Naphtha is an article which, either in liquid or gaseous form, is within common knowledge a dangerous substance, and is so mentioned in the laws of the United States. Sections 4472-4476, U. S. Rev. St. (U. S. Comp. St. 1901, pp. 3050-3052).

Under ordinary conditions of shipment or storage, such as storage in ordinary warehouses without special ventilation, shipment in closed freight cars, without special ventilation, and all the ordinary methods of shipping, handling, storing in warehouses, stores and in dwellings while awaiting consumption, the vapor gives off so slowly that it does not accumulate or combine with air in sufficient quantities to be dangerous. Prior to the explosion on the *Haverford*, no fire or explosion was ever known to have been caused by the soap, although it had for many years been shipped, stored, handled and used by manufacturer,

carrier, warehouseman, jobber, retail dealer and consumer under a great variety of conditions.

In 1900, Joseph Fels called on P. F. Young, now the libellant's Philadelphia manager and then the manager at Philadelphia of the Atlantic Transport Line, a line now operated by the libellant, to arrange about the shipment of large quantities of soap abroad and to ascertain what ventilation would be furnished. Mr. Fels then told Mr. Young that the soap contained naphtha, that the fumes thereof were given off slowly and that if the soap were confined in a space without ventilation there might be some trouble from explosion and that while the respondents did not expect anything of the kind, they wished to guard against it. Mr. Young after considering the matter, wrote a letter declining to carry the soap. This letter was as follows:

"Philadelphia, February 13th, 1900.

Messrs. Fels & Co.,
No. 1710 Market Street,
Philadelphia, Pa.

Gentlemen:—

Referring to conversation had with your Mr. Fels at this office, the writer regrets that absence from the City prevented his keeping the appointment made with you to go down on board the s/s 'Maryland' before she sailed; the s/s 'Maryland' sailed yesterday.

As regards our carrying this Soap, we have given the subject quite a little thought and have come to the conclusion that we would prefer not to carry it.

Yours truly,

P. F. Young, Phila. Manager."

A few days later another letter was written by Mr. Young to the respondents as follows:

"Philadelphia, February 16th, 1900.

"Messrs. Fels & Co.,
No. 1710 Market Street,
Philadelphia, Pa.

Gentlemen:—

We have yours of the 15th instant, asking the writer to stop at your Office today or tomorrow, and he would be very glad to do so if there was anything to be gained, but we have already written you that we have decided not to carry on our Steamers Fels' Naptha Soap, as described by you, so we don't think anything can be gained by further discussion of the subject.

If at any future day we change our minds, we will be very glad to at once communicate with you.

Yours truly,

P. F. Young, Phila. Manager."

Mr. Young at first denied he had received any notice of the dangerous character of the soap, but upon the letters being shown him he said:

"Redirect examination by Mr. Montgomery:

Q. What in reference to these letters did Messrs Fels & Company tell you about the nature of the soap at the time the letters were written by you, as manager of the Atlantic Transport Company? A. It is only proper that I should say, in connection with these letters, and my previous statement that I had no recollection of having had any conversation or any communication with Fels & Company in regard to naphtha soap, that a good many letters were written within the period from 1900 to 1908, and these letters had escaped my memory; in answer to your question, Mr. Montgomery, I now recall that with the production of those letters, Mr. Fels, I don't remember

which one it was, called at the office and made a request for a separate compartment to be designated on board the Maryland, a small freight steamer, not in any sense a passenger or modern steamer; in fact, it was the first steamer the Atlantic Transport Company ever built; I told him that I could not see that there was any business in that; neither did I see any necessity; as I recall Mr. Fels' reply was, 'What is naphtha soap?' I think I said, 'I think it is very much like an advertisement in any event we cannot contract with you to carry the specific quantity described,' the capacity of the compartment being greatly above his measurement, in carrying soap; as my memory serves me that was the conversation; I do not recall anything that was said in regard to this dangerous cargo, beyond what I have recited.

Q. Nothing was ever said to you thereafter about this being dangerous or inflammable? A. Nothing; I have no recollection of any conversation other than the one I have just described.

Q. Your objection was on the ground that Mr. Fels wanted a compartment in the ship separate and apart for the soap? A. Exactly.

Q. You did not care to let a contract that way? A. Not unless the shipper agreed every voyage of that ship to furnish the capacity of that compartment so assigned.

Q. Did Mr. Fels agree to that? A. He did not.

Q. Did you make any investigation of the soap afterwards? A. No, sir, we did not make any investigation of the soap afterwards because I never thought it had any dangerous qualification to it, as I thought it was an advertisement, the words 'naphtha' the same as monkey soap is an advertisement neither of which, as far as I know contain naphtha or monkeys, and I therefore was not serious in the matter.

Q. Was the Atlantic Transport Company at that time, of the writing of the letters, a part of the International Mercantile Marine Company? A. No sir.

Recross-examination by Mr. Cox:

Q. How distinct is your recollection of your interview with Mr. Fels? A. It is as distinct as I have described it.

Q. I notice in the letter Respondents' Exhibit B you speak of Fels' Naphtha soap as described by you? A. Yes.

Q. Do you remember to what that referred? A. As I just previously said, my recollection is that Mr. Fels rather wanted to give me the impression that it had naphtha in it.

Q. Don't you think he distinctly gave you that impression? A. No, he did not give me that impression; he gave me his views on it, but he did not give me that impression.

By the Court: Q. Do you mean from what he stated? A. He stated, as I remember, that it had naphtha in it, but I do not recall that Mr. Fels stated that it had a dangerous percentage of naphtha in it, and if I am not entirely wrong Mr. Fels illustrated that it was not a dangerous commodity, by sending out one of my office boys—it comes to me just as I am talking—and bought some four or five packages of soap.

Q. Of this soap? A. Fels Naphtha soap, and sought to ignite it or bring out a flame or odor or something of that kind from the applying of the match but it was not any different in that connection from ordinary soap, as far as I could see.

Q. What effect did the match have? A. As far as I saw, and I remember Mr. Fels' conversation with me, he did not say it brought any fumes or any light of any description.

By Mr. Cox: Q. Notwithstanding Mr. Fels' statement that the soap contained naphtha, did you still think the name 'naphtha' was merely a name? A. There are two different shipments of soap, and two different kinds; I merely mentioned that as I did to describe it; but I did not think Fels Naphtha soap contained any naphtha worth considering, as a result of my conversation with Mr. Fels at that time.

Q. What reason do you remember that Mr. Fels gave for wanting a separate compartment? A. I can't remember that; I think though it was ventilation, but I don't recall it."

Mr. Fels gave the following account of his conversation with Mr. Young:

"I said Fels-Naphtha soap contained naphtha; certain portions of the vapor from naphtha—Fels-Naphtha soap were given off slowly and if the soap was confined in a narrow space without ventilation there might occur some trouble, and explosion, and while we were not looking for anything of that kind, we wanted to do whatever we could to guard against it."

I think the foregoing tends to corroborate Mr. Fels' version of the matter.

Mr. Bettle, a witness for libellant, was connected with the American Line before July 1st 1904, with an office in New York. He was general freight agent for the line to which the Haverford belonged. He said that he did not know the soap was being carried but that a shipper in Philadelphia would approach the East Bound Freight Agent and that he (Bettle) would be consulted by such agent, who was a Mr. McKinstry. Mr. Joseph Fels testified that he went to see Mr. Mr. McKinstry and stated to him:

"Q. What did you tell him about the soap, if anything? A. I said to him that Fels-Naphtha soap was—we were about opening a trade abroad, and I wanted to come down to see him in order that the American Line as well as every other steamship line which we offered business to should know just the character of goods we were shipping, in that it contained naphtha which would give off vapors, especially in confined places, and that though we had never had any trouble since we were in the business about any explosion or fires, but that with the use of naphtha we wanted to run no risk, and would prefer not to do any business unless it was thoroughly understood by those people who should receive the goods, meaning the transportation companies; I further stated that we could not ship the goods at all unless there was proper ventilation on the boat, by reason of the fact that some trouble might occur and that there might be an explosion by reason of the confined vapor."

Mr. McKinstry in speaking of the interview with Mr. Joseph Fels, said:

"Q. Will you kindly state what it was he said to you about it? A. Well, he told me the other lines had refused to carry it; some of these lines had refused to carry it on account of its having a percentage of naphtha in it, and that there was some disposition to suppose that there might be danger connected with it, and they had refused to take it; he did not want us to take it under a misapprehension; he said the soap gave off some fumes, or vapor, or something of the kind, and in a confined space something might happen, but that it was carried on box cars on railways, and in a ventilated space the probabilities were nothing could happen. * * *

A. On account of the possibility of the fumes in a confined space, resulting in something.

Q. Did he use the word something? A. No; that it might be dangerous to have the fumes confined; whether that something was explosion or flames I don't know."

Mr. Fels also said:

"Q. Did Mr. McKinstry say anything about providing space where there would be ventilation? A. He did.

Q. What was it? A. He offered us the cattle deck.

Q. Did he say how much ventilation there was there? A. He said practically the cattle deck is practically equal, so far as all intents and purposes are concerned, to the outside."

Mr. McKinstry on the 25th of August, 1902, sent a telegram to one of his superiors in which he inquired, referring to the soap: "Would you consider it a dangerous product in any sense of the word?" Mr. McKinstry understood the soap was to be carried in a fully ventilated place. Mr. Fels reported the interview with Mr. McKinstry to his office and in consequence measurements of a box of soap were sent to Mr. McKinstry. He replied:

"We have your yesterday's favor, giving figures on your soap. We quote the rate of 10/- and 5% primage per 2240 lbs., Philadelphia to Liverpool, per S. S. Haverford appointed to sail hence Sept. 20th. Please advise us if you wish us to reserve room."

Mr. Collingswood, a clerk in the employ of the respondents, made a pencil memorandum on the letter as follows:

"1,000 provided it is compartment on cattle deck between two cattle compartments."

The respondents sent a letter to the International Navigation Company on September 17, 1902, as follows:

"We enclose bill of lading for 1093 boxes of Fels-Naptha soap shipped by Pa. R. R. to your Washington Street Wharf. Two cars. These goods are intended to go on the S/S 'Haverford,' in the compartment arranged for by us. Please advise us when we can get bill of lading for same."

The words the "compartment arranged for by us" can only refer to the arrangement between Mr. Fels and Mr. McKinstry.

Mr. Samuel S. Fels saw Mr. McKinstry in December, 1902, and was informed that the company was taking pains to carry the soap in the decks.

The libellant's cargo superintendent, in writing to the respondents November 24, 1902, said:

"The smell arising from this soap resembles very much naphtha, but it quickly passes away when exposed to the air, but when confined below without good ventilation becomes very offensive, and I am quite satisfied that it will very seriously damage flour or anything of that nature that might be stowed with it; otherwise, I do not consider it a dangerous commodity, and I see no reason why it should not be carried if care is taken to give it proper storage."

Mr. Wallace, the dock superintendent for the libellant, said, referring to Mr. McKinstry:

"Q. He has told us here that he spoke to you, or someone, he couldn't be sure who, stating that the soap ought to be stowed in the between decks. A. That must have been me, because he wouldn't speak to anybody else.

Q. You wouldn't doubt that he told you that? A. I won't say that he didn't tell me; he might have done it; if he says he said so I guess he did; but I don't remember."

I fail to see how there can be any doubt that the respondents sufficiently informed the libellant of the character of the goods they were shipping.

Apart, however, from notice by the respondents, the packages themselves gave notice of the character of the goods. The packages have been described herein and they advised any one who saw them that they contained a possibly dangerous commodity. When the libellant handled the goods as though they were absolutely harmless, it took the risk in-

volved. The Supreme Court has said in this connection (*Wood v. Carpenter*, 101 U. S. 135, 141, 25 L. Ed. 807):

"Whatever is notice enough to excite attention and put the party on his guard and call for inquiry, is notice of everything to which such inquiry might have led. When a person has sufficient information to lead him to a fact, he shall be deemed conversant of it." *Kennedy v. Green*, 3 Myl. & K. 722. "The presumption is that if the party affected by any fraudulent transaction or management might, with ordinary care and attention, have seasonably detected it, he seasonably had actual knowledge of it." *Angell, Lim.* § 187 and note."

The proper place for notice was on the packages themselves and when the respondents published in such way the fact that the soap contained a notoriously dangerous ingredient, it seems that they fulfilled their duty to this carrier, which could not supinely assume that the notice meant nothing. In addition to the fact heretofore alluded to that naphtha is pronounced a dangerous commodity by the U. S. Statutes, it is a notorious fact that such article is explosive. Prof. Munroe testified:

"Q. It has been suggested in the testimony here that while the word n-a-p-h-t-h-a might afford notice of the fact that the goods were possibly explosive or might give off gases, the word naphtha would not; what do you think of that? A. I have had occasion to deal with the matter officially, and in many of the reports which I have received in my work for the United States Census Bureau, these being reports from all the individual makers, where they had occasion to make use of the lighter petroleum distillate, they have spelled the word n-a-p-h-t-h-a and n-a-p-t-h-a, and there was no doubt as to what was meant; it was the slight petroleum distillate.

Q. Can you state from your experience whether or not it has long been common knowledge that naphtha gives off vapors? A. Yes.

Q. Can you state whether or not it has long been a matter of common knowledge that naphtha is a dangerous substance on account of its inflammable and explosive qualities. A. It has; as long ago as the time of Pliny.

Q. More conspicuously recently? A. More particularly since 1871, since the work of Professor Chandler done here in the city of New York upon dangerous kerosenes, that work being done for the Board of Health and published widely, has been widely circulated through literature, and widely commented upon in the newspaper press, particularly in connection with the accidents that have occurred from the light petroleum distillates."

The use of the word "naphtha" was notice that the goods at least required special care. *Doherr v. Houston* (D. C.) 123 Fed. 334, 335, affirmed 128 Fed. 594, 64 C. C. A. 102.

The libellant had in fact knowledge that the commodity it was handling was naphtha from its very strong smell. It was accustomed to testing the air of the compartment in which it was stowed before allowing the workmen to go there. The Liverpool agents of the line advised their correspondents in Philadelphia not to stow the soap under other cargo as it would so affect the men that they would act as if drunk. It was well known to the Liverpool agents of the line that the strong smell existed in connection with the soap and that smell could only mean the presence of naphtha. It was a matter of common knowledge that the accumulation of naphtha vapor in connection with air created a dangerous and explosive compound.

I think that the failure of the libellant to properly provide for the transportation of the soap with respect to ventilation, was the proximate

cause of the explosion. It would only occur under very exceptional circumstances but the failure to provide for such circumstances was at the libellant's, not the respondents', risk. The latter felt it incumbent upon them to notify the libellant that there was a possibility of danger and when they gave the notice alluded to herein, they discharged themselves from liability. If they had not given such notice, it is probable that the notice from the markings on the packages and the other indications of the presence of naphtha, would have been sufficient to make the libellant responsible for the effects of the explosion. Doubtless the libellant and its predecessors had become so accustomed to carrying the soap with safety that they failed to be impressed with the possible danger and when it stowed the goods in a hold of the vessel, where there was only partial ventilation, just enough to create perilous conditions, a situation resulted from which the accident ensued.

The second question is answered in the affirmative.

It follows that the libellant can not succeed and that the libel must be dismissed.

UNITED STATES v. SOUTHERN RY. CO.

(District Court, N. D. Alabama, S. D. September 25, 1908.)

No. 115.

1. COMMERCE (§ 58*)—REGULATION—SAFETY APPLIANCE ACTS.

The acts of Congress known as the "Safety Appliance Acts" (Act March 2, 1893, c. 196, 27 Stat. 531 [U. S. Comp. St. 1901, p. 3174], and amendments thereto, Act April 1, 1896, c. 87, 29 Stat. 85, and Act March 2, 1903, c. 976, 32 Stat. 943 [U. S. Comp. St. Supp. 1907, p. 885]), are within the power conferred by the Constitution of the United States upon Congress, and are not violative of subdivision 3 of section 8 of article 1 thereof.

[Ed. Note.—For other cases, see Commerce, Cent. Dig. §§ 77-86; Dec. Dig. § 58.*]

2. COMMERCE (§ 58*).

The safety appliance acts are not violative of the tenth amendment to the Constitution of the United States.

[Ed. Note.—For other cases, see Commerce, Cent. Dig. §§ 77-86; Dec. Dig. § 58.*]

3. COMMERCE (§ 58*)—REGULATION—SAFETY APPLIANCES.

Congress, having determined by formative action to regulate the use of cars running upon a railroad between the states so as to provide for the use of certain safety appliances on such cars running thereon, has by said acts taken affirmative action in regard thereto, and to this extent the action by Congress is exclusive.

[Ed. Note.—For other cases, see Commerce, Dec. Dig. § 58.*]

Duty of railroad companies to furnish safe appliances, see note to Felton v. Bullard, 37 C. C. A. 8.]

4. COMMERCE (§ 58*)—INTERSTATE COMMERCE—SAFETY APPLIANCE ACT—"RAILROAD ENGAGED IN INTERSTATE COMMERCE."

The reference in Act March 2, 1903, c. 976, 32 Stat. 943 (U. S. Comp. St. Supp. 1907, p. 885), to "any railroad engaged in interstate commerce" applies to the interstate highway as an instrument of commerce; and, Congress having taken affirmative action in reference thereto, its control of the interstate highway being thereby conclusive, the statute requiring vehicles running on the interstate highway to be provided with certain safety appliances embraces all uses of the highway, whether for the

*For other cases see same topic & § NUMBER in Dec. & Am. Digs. 1907 to date, & Rep'r Indexes

transportation of interstate traffic or for the transportation of traffic from a point within a state to another point within the same state by common carriers engaged in interstate commerce.

[Ed. Note.—For other cases, see Commerce, Cent. Dig. §§ 77–86; Dec. Dig. § 58.*]

5. COMMERCE (§ 58*)—INTERSTATE COMMERCE.

The principle decided in the employer's liability cases (207 U. S. 463, 28 Sup. Ct. 141, 52 L. Ed. 297) is not decisive of the issues of this case. In the former case the statute under consideration was addressed to the individuals or corporations engaged in interstate commerce, whereas in the case at bar the statutes are addressed alone to the use of an instrument of interstate commerce, viz., an interstate railroad highway.

[Ed. Note.—For other cases, see Commerce, Dec. Dig. § 58.*]

6. COMMERCE (§ 58*)—RAILROADS.

Congress has power, not only under the commerce clause of the Constitution to regulate interstate commerce and the instrumentalities thereof, but also by virtue of its police power to provide for the protection of railroad employes and the traveling public by prescribing safeguards for vehicles, etc., used over an interstate highway or any portion thereof. Under the safety appliance acts, therefore, a failure to provide vehicles, etc., with the safety appliances required by the acts is a violation thereof, when the trains, cars, etc., are operated over any portion of the highway, even though that portion be from a point within a state to another point within the same state.

[Ed. Note.—For other cases, see Commerce, Dec. Dig. § 58.*]

7. COMMERCE (§ 58*)—INTERSTATE COMMERCE—REGULATION—POWER OF CONGRESS.

Railroads engaged in interstate commerce are subjects of such commerce, national in their character, requiring uniformity of regulation, and the power of Congress over the same is exclusive. This power, like all others vested in Congress, is complete in itself, may be exercised to the utmost extent, and acknowledges no limitations other than are prescribed in the Constitution. The sovereignty of Congress, though limited to specified objects, is plenary as to those objects. The power over commerce among the several states is vested in Congress as absolutely as it would be in a single government, having in its Constitution the same restrictions on the exercise of the power as are found in the Constitution of the United States.

[Ed. Note.—For other cases, see Commerce, Cent. Dig. §§ 77–86; Dec. Dig. § 58.*]

(Syllabus by the Court.)

8. COMMERCE (§ 1*)—WHAT CONSTITUTES.

Transportation of persons and property is "commerce."

[Ed. Note.—For other cases, see Commerce, Cent. Dig. § 2; Dec. Dig. § 1.*]

For other definitions, see Words and Phrases, vol. 2, pp. 1287–1293; vol. 8, pp. 7606–7607.]

At Law. On demurrer to petition to recover penalties for violation of safety appliance acts.

O. D. Street, U. S. Atty., and Roscoe F. Walter, Sp. Counsel, for the United States.

Weatherly & Stokely, for defendant.

HUNDLEY, District Judge. This is an action brought by the United States against the Southern Railway Company to recover from the defendant railway penalties for failure to equip its cars with automatic couplers and other devices required by the acts of Congress known as the "Safety Appliance Acts." Act March 2, 1893, c. 196,

*For other cases see same topic & § NUMBER in Dec. & Am. Digs. 1907 to date, & Rep'r Indexes

27 Stat. 531 (U. S. Comp. St. 1901, p. 3174), as amended by Act April 1, 1896, c. 87, 29 Stat. 85, and Act March 2, 1903, c. 976, 32 Stat. 943 (U. S. Comp. St. Supp. 1907, p. 885). The petition is in five different counts or causes of action, each count referring to a separate and distinct car which, it is averred, was not provided with the safety appliances required by the acts of Congress. The first count or cause of action is in words and figures as follows, to wit:

"For a first cause of action, plaintiff alleges that said defendant is a common carrier engaged in interstate commerce by railroad among the several states and territories of the United States, particularly the states of Virginia, Tennessee and Alabama.

"Plaintiff further alleges that in violation of the act of Congress, known as the 'Safety Appliance Act,' approved March 2, 1893 (contained in 27 Statutes at Large, page 531), as amended by an act approved April 1, 1896 (contained in 29 Statutes at Large, page 85), and as amended by an act approved March 2, 1903 (contained in 32 Statutes at Large, page 943), said defendant, on or about February 8, 1907, hauled on its line of railroad one car, to wit, Southern No. 70057, used in the movement of interstate traffic, to wit, coal consigned from Birmingham, in the state of Alabama, to Charleston, in the state of South Carolina.

"Plaintiff further alleges that on or about said date defendant hauled said car with said interstate traffic over its line of railroad from Birmingham, in the state of Alabama, in a southerly direction, within the jurisdiction of this court, when the coupling and uncoupling apparatus on the 'A' end of said car was out of repair and inoperative, the chain connecting the lock pin or lock block to the uncoupling lever being broken on said end of said car, thus necessitating a man or men going between the ends of the cars to couple or uncouple them, and when said car was not equipped with couplers coupling automatically by impact, and which could be uncoupled without the necessity of a man or men going between the ends of the cars, as required by section 2 of the safety appliance act, as amended by section 1 of the act of March 2, 1903.

"Plaintiff further alleges that by reason of the violation of the said act of Congress, as amended, defendant is liable to plaintiff in the sum of one hundred dollars."

The second cause of action differs from the first only in referring to the car hauled as follows:

"Said car being one regularly used in the movement of interstate traffic and at the time of said violation being loaded with coal consigned from Birmingham, Alabama, to Selma, Alabama.

"Plaintiff further alleges that said line of railroad over which said car was hauled on said date is a part of a through highway over which interstate traffic is being continually hauled from one state in the United States to another state in the United States."

The third and fifth causes of action are identical with the second cause of action, with the exception of averring the breach of the requirements of the statute being on a different car, and the fourth cause of action is identical with the first cause, with this same exception.

To the various counts or causes of action stated in the petition the defendant railway company filed the following demurrer:

"Comes the defendant, the Southern Railway Company, and demurs to the petition filed in this cause as a whole, and to each and every separate part thereof purporting to state a separate cause of action from first to fifth, inclusive, on the ground that the said act of Congress, upon which said petition is based, and known as the 'Safety Appliance Act,' approved March 2, 1893,

as amended by an act approved April 1, 1896, and as amended by an act approved March 2, 1903, is violative of the Constitution of the United States in the following particulars, namely:

"(1) That it exceeds the power granted to Congress of the United States by the Constitution thereof, and especially by subdivision 3 of section 8 of article 1 thereof, in that it attempts, under the guise of regulating commerce among the several states, to regulate the use and operation of vehicles and other instrumentalities of railroads which are used in the carrying on of intrastate commerce.

"(2) Said act is not authorized by said subdivision 3 of section 8 of article 1 of the Constitution of the United States.

"(3) Said act authorizes, or attempts to authorize, the imposition of a penalty upon railroad companies engaged in interstate commerce, irrespective of whether or not the cars, vehicles, or other instrumentalities used by such railroad company is at the time of the use of such car, vehicle, or other instrumentality engaged exclusively in intrastate commerce.

"(4) Said act purports to apply to a car or other instrumentality of a common carrier solely because used or engaged regularly in interstate commerce, without respect to whether or not at the time it is actually being engaged exclusively in the movement of interstate traffic.

"(5) Said act is violative of article 10 of the Constitution of the United States.

"And the defendant further demurs specially to that part of the petition setting forth a second cause of action, and separately and severally to that part of the petition setting forth a third cause of action, and separately and severally to that part of said petition setting forth a fifth cause of action, on the following ground, namely:

"(1) Because each of said parts of said petition shows on its face that the movement of the car in the particular case was a local movement, namely: In the second cause of action a movement of Southern car No. 69319, loaded with coal, 'consigned from Birmingham to Selma, Alabama'; in the third cause of action, Southern car No. 97921, loaded with coal, 'consigned from Birmingham to Selma, Alabama'; and the fifth cause of action, T. C. S. & D. No. 19332, loaded with coke, 'consigned from Pratt City, Ala., to Mobile, Alabama.'"

Three questions are thus presented for the decision of the court by this demurrer. The first is: Is the act of Congress approved March 2, 1893, with the amendments thereto, and commonly known as the "Safety Appliance Act," a valid exercise by Congress of the power delegated to it under the commerce clause of the Constitution of the United States? The second is: Has Congress, in the acts referred to, so assumed those powers reserved to the states as to render the acts abhorrent to the tenth amendment to the Constitution? The third question is: If they are a valid exercise of the right conferred upon Congress by the Constitution, is a proper cause of action stated under the second count in the petition and the other counts similar thereto?

It is argued by counsel for the defendant with great earnestness that the language employed in the act approved March 2, 1903, defining and declaring that the provisions and requirements of the original safety appliance act "shall be held to apply to all trains, locomotives, tenders, cars, and similar vehicles used on any railroad engaged in interstate commerce," renders the acts invalid, because they are thus made to apply with equal force to trains, locomotives, etc., engaged entirely within the states and with relation to intrastate commerce alone. In this connection it is also argued that the decision of the Supreme Court of the United States in the cases known as the "Em-

ployer's Liability Cases," 207 U. S. 463, 28 Sup. Ct. 141, 52 L. Ed. 297, is decisive of the first question presented, and this court is directed especially to the dissenting opinion of Mr. Justice Moody, in which he uses the following language in referring to the employer's liability act (Act June 11, 1906, c. 3073, 34 Stat. 232 [U. S. Comp. St. Supp. 1907, p. 891]):

"If the statute now before us is beyond the constitutional power of Congress, surely the safety appliance act is also void, for there can be no distinction in principle between them."

While a dissenting opinion is never binding upon the courts as a decisive statement of the law, yet the statement herein quoted, coming as it does from so high a source, is entitled to very great weight and influence in guiding the court to determine the issues here involved. If the learned justice is right in his conclusion that there can be no distinction in principle between the employer's liability act and the safety appliance acts, it follows as a matter of course that the decision of the Supreme Court of the United States in relation to the former act would apply with equal force to the latter acts, and I would deem it my duty to follow that court and declare the acts in question unconstitutional and void. The distinction between the principle decided in the Employer's Liability Cases and the safety appliance acts was not drawn in question when the former cases were pending before the Supreme Court of the United States, and I feel constrained to believe that the statement above quoted from Mr. Justice Moody was for that reason unadvisedly made; for the distinction between the two acts, with due respect to the learned justice, is in my humble judgment very marked. The conclusion arrived at by the majority of the court in its opinion in the Employer's Liability Cases was based upon the fact, shown both in the title and the body of the statute, that it dealt with all the concerns of individuals and corporations, and did not confine itself to the interstate commerce business which might have been done by such persons or corporations; in fine, that intrastate subjects were, with equal force and effect, embraced within the terms of the act. Says the Supreme Court in that case, after discussing the terms of the statute:

"From this it follows that the statute deals with all the concerns of the individuals or corporations to which it relates, if they engage as common carriers in trade or commerce between the states, etc., and does not confine itself to the interstate commerce business which may be done by such persons. Stated in another form, the statute is addressed to the individuals or corporations who are engaged in interstate commerce, and is not confined solely to regulating the interstate commerce business which such persons may do; that is, it regulates the persons because they engage in interstate commerce, and does not alone regulate the business of interstate commerce."

The very title of the employer's liability act shows that it was the intention of Congress to apply the terms of the act to "common carriers" engaged in interstate commerce, and not to the "business" of such commerce. Again, says the Supreme Court in the Employer's Liability Cases, supra:

"The act, then, being addressed to all common carriers engaged in interstate commerce, and imposing a liability upon them in favor of any of their em-

ployés, without qualification or restriction as to the business in which the carriers or their employés may be engaged at the time of the injury, of necessity includes subjects wholly outside the power of Congress to regulate commerce."

When we come to consider the safety appliance act, both in the title and body of the act, together with the application made by the amendment, the distinction which is decisive of the questions here raised becomes apparent. In the outset it is seen that the title of the act shows that the purpose of the legislation is "to promote the safety of employés and travelers upon railroads by compelling common carriers engaged in interstate commerce to equip their cars with certain appliances for the safety of the employés and the traveling public." When the first safety appliance act was enacted by Congress, which was the act of March 2, 1893, the penalties under the act were confined to any railroad company which uses "any car in interstate commerce" that is not provided with appliances referred to in the act. Surely there is no kind of construction which would hold that this reference could mean any car in intrastate commerce. By the terms of the act approved March 2, 1903, the application of the original act was enlarged, so as to make it apply "to all trains, locomotives, tenders, cars and similar vehicles used on any railroad engaged in interstate commerce, * * * and all other locomotives, tenders, cars and similar vehicles used in connection therewith." It is this language, it is claimed, which brings this statute within the principle decided in the Employer's Liability Cases. By the very terms of the act the distinction will be noted that, while the employer's liability act applies to "individuals and corporations," the safety appliance act, as amended, applies to the instrumentalities engaged in interstate commerce and the use of those instrumentalities "on any railroad engaged in interstate commerce." Here reference is made to the national interstate highway alone, used in interstate commerce, and by no system of reasoning can this reference be properly held to apply to an intrastate highway. As is said by the Supreme Court in the Employer's Liability Cases, supra (referring to the employer's liability act), "the statute is addressed to the individuals or corporations," while it is clear that in the case at bar the statute is addressed to the instrumentality of commerce, viz., the railroad—interstate highway. So that the question at issue before the court resolves itself simply into the proposition: Has Congress the right to regulate the interstate highway and the use of vehicles thereon? Has it authority to provide for the safety of employés and travelers while using the interstate highway? If Congress has the right to so regulate this interstate highway, does the inhibition of the statute apply to the use thereof for purposes of transportation of commerce between points entirely within a state? Has Congress a right, also, under its police authority, to say that this highway shall be safe and unobstructed?

I take it that it is unnecessary for me, at this late date in the history of our country, to cite authorities in support of the proposition that the transportation of persons and property is commerce; in other words, that the business of carriers is commerce, and when this business is

foreign or interstate it has been frequently decided that the power to legislate for its direct control is lodged within the power of Congress, and this power is paramount. It was decided in the Debs Case, 158 U. S. 564, 15 Sup. Ct. 900, 39 L. Ed. 1092, that the obstruction of such commerce was unlawful under the laws of the United States, could be suppressed by the armies of the United States, and at the instance of the United States could be enjoined in its courts. Speaking of the power of Congress to regulate commerce, Mr. Chief Justice Marshall, in the great case of *Gibbons v. Ogden*, 9 Wheat., on page 196, 6 L. Ed. 23, says:

"It is the power to regulate; that is, to prescribe the rule by which commerce is to be governed. This power, like all others vested in Congress, is complete in itself, and may be exercised to its utmost extent, and acknowledges no limitations, other than are prescribed in the Constitution."

Nor has this power of Congress to regulate commerce been held to apply only to persons or corporations engaged in that commerce, but it has been held to apply to every instrumentality of commerce. Says Mr. Justice Johnson in his concurring opinion in *Gibbons v. Ogden*, 9 Wheat., on page 229, 6 L. Ed. 23:

"Commerce, in its simplest signification, means an exchange of goods; but, in the advancement of society, labor, transportation, intelligence, care, and various mediums of exchange, become commodities, and enter into commerce. The subject, the vehicle, the agent, and their various operations, become the objects of commercial regulations."

In *Cooley v. Port Wardens*, 12 How. 299, 13 L. Ed. 996, the court, in holding that the regulation of pilots is regulation of commerce within the meaning of the commerce clause, says:

"It extends to the persons who conduct it, as well as to the instruments used."

Mr. Justice Field, in *Sherlock v. Alling*, 93 U. S. 99, 23 L. Ed. 819, delivering the opinion of the court, says:

"It is true that the commercial power conferred by the Constitution is one without limitation. It authorizes legislation with respect to all the subjects of foreign and interstate commerce, the persons engaged in it, and the instruments by which it is carried on."

Mr. Justice Field, in the case of *Gloucester Ferry Company v. Pennsylvania*, 114 U. S., on page 203, 5 Sup. Ct., on page 828, 29 L. Ed. 158, in delivering the unanimous opinion of the Supreme Court, says:

"The means of transportation of persons and freight between the states does not change the character of the business as one of commerce, nor does the time within which the distance between the states may be traversed. Commerce between the states consists of intercourse and traffic between their citizens, and includes the transportation of persons and property, and the navigation of public waters for that purpose, as well as the purchase, sale, and exchange of commodities. The power to regulate that commerce, as well as commerce with foreign nations, vested in Congress, is the power to prescribe the rules by which it shall be governed—that is, the conditions upon which it shall be conducted—to determine when it shall be free and when subject to duties and other exactions. The power also embraces within its control all instrumentalities by which that commerce may be carried on, and the means by which it may be aided and encouraged."

Again, says Mr. Justice Harlan, in affirming the decree of the lower court in the case of Northern Securities Company v. United States, 193 U. S. 350, 24 Sup. Ct. 462, 48 L. Ed. 679:

"Whilst every instrumentality of domestic commerce is subject to state control, every instrumentality of interstate commerce may be reached and controlled by national authority, so far as to compel it to respect the rules for such commerce lawfully established by Congress."

From the decisions to which I have just referred, it is plain that it has been decided in no uncertain terms that Congress has a right not only to regulate individuals or corporations engaged in interstate commerce, but the instrumentalities of such commerce as well. This being settled by the courts, thus it follows that the "instrumentalities" are as much a part of commerce as the business thereof, and the power of Congress to regulate the one is as full and complete as its power to regulate the other. The engine engaged in interstate commerce is an instrumentality of that commerce and may be regulated by Congress. The cars, and the rails upon which the cars are run, are all instrumentalities of commerce. The highway upon which the cross-ties and the rails rest, when this highway with its cross-ties and rails runs from one state to another, is an instrumentality of commerce, falling within the purview of the Constitution, which confers upon Congress the right to regulate interstate commerce. From what has been said above, and the authorities cited, it is plain, therefore, that Congress, in regulating those instrumentalities of commerce, to wit, "trains, locomotives, tenders, cars and similar vehicles used on any railroad engaged in interstate commerce," was acting entirely within the scope of its authority conferred by the Constitution; and the first four grounds of the demurrer are, therefore, not well taken.

I now come to the fifth ground of the demurrer, to wit, that the acts of Congress in question are violative of the tenth amendment to the Constitution of the United States, which amendment is as follows:

"The powers not delegated to the United States by the Constitution, nor prohibited by it to the states, are reserved to the states respectively, or to the people."

The argument in support of this ground of demurrer is that the attempt of Congress to regulate the interstate highway in the manner set forth in the safety appliance acts is an unconstitutional assumption by Congress of those powers which were reserved to the various states of the Union or to the people; that inasmuch as any proper construction of those acts must, of necessity, include the use of the highway for the purpose of carrying on commerce between two points entirely within a state, this is an encroachment upon the reserved powers of the states to regulate their internal affairs, and was not conferred upon Congress by the Constitution. This question—that is, the dividing line between state and federal control—has been, and I presume always will remain, a question of great importance, and it has received the thought and consideration of jurists and scholars since the foundation of our government. I shall not attempt to review the many arguments and judicial decisions which have had reference to this great question, but shall content myself by stating suc-

cinctly my reasons for reaching my conclusion upon this ground of the demurrer. This conclusion is based upon what I conceive to be the fundamental policy of this government, as determined not alone by its legislation, but by the decisions of the Supreme Court. To determine the question whether the particular power which is here challenged has been reserved to the state or granted to the general government by the people in their Constitution depends upon a fair construction of the Constitution as a whole, including the amendments.

The United States is a nation, and its Constitution is the organic fundamental law of that nation. The people of this nation existed as a people prior to the adoption of the Constitution, and hence, in primis these people were not called into being as a consequence of that instrument alone. The people collectively existed as a political unit. Prior to the adoption of the Constitution, the states, as states, did not exist as separate states, regarding themselves simply as distinct organized governments. The peoples of those states, prior to the adoption of the Constitution, were not separate, independent, sovereign aggregates or communities. They did not assemble in the Convention which framed the Constitution as representatives of independent nations or sovereignties. The Constitution, therefore, was the work of the people of the United States as a whole. It is true that they did not vote together as a solid mass of electors, but they were acting in their respective commonwealths for reasons of policy and convenience. As a necessary consequence of this view the powers of the general government cannot be said to have been delegated to it by the several states in the light of organized governments, nor by the peoples of those several states, regarding those people as separate and independent sovereign aggregates or communities. The powers held by the general government were, therefore, necessarily delegated to it by the people of the United States as a whole, abstracted from their local relations to the various commonwealths of which they were also members. Now, let us carefully note the reading of the amendment under discussion, and determine, if we can, by whom were the powers not delegated by the people of the United States to the general government reserved. Were they reserved by the several states to themselves? Surely this construction cannot be correct; for, if these states were not independent nations or sovereignties before the Constitution was adopted, they could not grant any powers, and hence they could not reserve any. As is said by Pomeroy in his work on Constitutional Law, speaking of the powers granted to the general government, as well as those reserved to the states:

"The powers not thus granted by the people of the United States to its general government were not reserved by the several states to themselves; for, as these states as such did not grant any powers, they could not reserve any. But they were reserved by the people of the United States to themselves, or to the several states. Thus the people of the United States, as a nation, is the ultimate source of all power, both that conferred upon the general government, that conferred upon each state as a separate political society, and that retained by themselves."

The same reservation as is here under discussion was contained in the second article of the Articles of Confederation, except that the

word "expressly" was there placed before the word "delegated." The omission of this word in the tenth amendment is most significant, and shows the object was not to interfere with or restrict any of the powers delegated to the United States by the Constitution, whether expressly delegated or not. *Metropolitan National Bank v. Van Dyck*, 27 N. Y. 416. I do not pretend to say that the construction placed upon the Constitution and the national character of the government of the United States here suggested has been at all times the fixed rule of construction in relation thereto by the Supreme Court of the United States and other courts of this country to such an extent that it may be deemed the settled rule of construction; but what I mean to say is that from this theory of the national character of our government and of the source of the powers granted to Congress under the Constitution have been evolved those various decisions of the Supreme Court of the United States and the other courts which have held that Congress has the power to go beyond the general regulations of commerce which it is accustomed to establish, to descend to the most minute directions if it shall be deemed advisable, and to whatever extent ground shall be covered by those directions the exercise of state power is precluded. As said by Judge Cooley in his work on *Constitutional Limitations* (7th Ed.), on page 856:

"Congress may establish police regulations, as well as the states, confining their operation to the subject over which it is given control by the Constitution."

It must not be understood that I am contending that Congress has the supreme power under the Constitution, or as a police regulation, to regulate the internal affairs of the states, or that the states cannot, under their police powers, enact laws for the orderly administration of state matters, and which may incidentally affect interstate commerce. The comprehensive statement of Mr. Chief Justice Marshall, in *Gibbons v. Ogden*, 9 Wheat., at page 194, 6 L. Ed. 23, has always been accepted by the Supreme Court as the proper statement of what matters of state control are not embraced in the grant of authority to Congress to regulate commerce. In that case it is said:

"It is not intended to say that these words comprehend that commerce, which is completely internal, which is carried on between man and man in a state, or between different parts of the same state, and which does not extend to or affect other states. Such a power would be inconvenient and is certainly unnecessary. Comprehensive as the word 'among' is, it may very properly be restricted to that commerce which concerns more states than one. * * * The genius and character of the whole government seem to be that its action is to be applied to all the external concerns of the nation, and to those internal concerns which affect the states generally, but not to those which are completely within a particular state, which do not affect other states, and with which it is not necessary to interfere, for the purpose of executing some of the general powers of the government."

The great interstate railroad highways of this country in a large number of cases have been made possible of success only by the expenditure of millions of dollars contributed by all of the people from the national treasury. Thousands of miles of these great highways are to-day located and built upon the public domain, generously granted by the sovereign people, through their representatives in Con-

gress, for the benefit and use of commerce between the states. That strictly national and exclusive governmental function, of carrying the mails is exercised by means of these great highways. It will thus be seen that by the very nature of things railroads between states are national in their character, and, when Congress determines to assume regulation thereof, its control must be, and is, exclusive and final. If Congress, therefore, under the power granted by the Constitution and under its police power, has a right to regulate the use of the interstate highway, surely that right cannot be impaired by any action of a state in conflict with the rules and regulations established by Congress. Uniformity of regulation affecting all the states is not only permissible, but is required. There must be only one system of rules applicable alike to the whole country, which Congress alone can prescribe. *Mobile County v. Kimball*, 102 U. S. 691, 26 L. Ed. 238. Interminable discord must of necessity prevail under our dual system of government if the power of Congress, once assumed, and the regulations prescribed by it, can be invaded by each and every state through which the great interstate highway runs. Within the field of congressional power, authorized by the Constitution of the United States, the federal power, to be effective at all, must be supreme in all parts of the United States. This declaration of supremacy as vouchsafed to the federal government is expressed in article 6, par. 2, of the Constitution of the United States, in the following words:

"This Constitution, and the laws of the United States which shall be made in pursuance thereof, and all treaties made, or which shall be made, under the authority of the United States, shall be the supreme law of the land, and the judges in every state shall be bound thereby, anything in the Constitution or laws of any state to the contrary notwithstanding."

What is the meaning of this declaration? They are surely not the idle and thoughtless words of a thoughtless people, but they are the deliberate sentiments of a sovereign people, who were building a temple within which their liberties were to be enshrined for all time. It means that so far as the people of the United States, the nation, have seen fit to delegate a portion of their own inherent powers of legislation and government to their appointed rulers, just so far those appointed rulers are supreme throughout the land in the exercise of those delegated powers. As is well stated by Mr. Chief Justice Waite in the case of *Pensacola Telegraph Company v. Western Union Telegraph Company*, 96 U. S. 1, 24 L. Ed. 708:

"The Constitution of the United States and the laws made in pursuance thereof are the supreme law of the land. Article 6, par. 2. A law of Congress made in pursuance of the Constitution suspends or overrides all state statutes with which it is in conflict."

Congress has chosen to act, and its action necessarily precludes the action of the state. *Pennsylvania v. Wheeling, etc., Company*, 18 How. 421, 15 L. Ed. 435.

From what has been stated above, and the authorities cited it is plain that the demurrer to those counts which aver that the cars were loaded with commodities consigned from a point within the state to another point within this same state is not well taken. They were hauled over a portion of an interstate highway and by a common car-

rier engaged in interstate commerce. Congress has said that no vehicles shall be used on this interstate highway which are in the condition alleged in the petition. Whether this interstate highway is used in the hauling of vehicles in the condition alleged in the petition from a point in one state to a point in another state or between points entirely within the same state, is immaterial in the application of the safety appliance statutes.

The demurrer, and each and every ground thereof, is overruled. It is so ordered.

ILLINOIS CENT. R. CO. v. A. WALLER & CO.

(Circuit Court, W. D. Kentucky. October 12, 1908.)

1. REMOVAL OF CAUSES — PARTY ENTITLED TO REMOVE — EFFECT OF COUNTERCLAIM.

A plaintiff in a suit in a state court for the recovery of a sum less than \$2,000 does not become theoretically or constructively a defendant, so as to entitle him to remove the cause on the ground of diversity of citizenship, because the defendant in his answer sets up a counterclaim for more than \$2,000, as permitted by the statute of the state, and which counterclaim under such statute would remain for trial, although the plaintiff should dismiss his action.

[Ed. Note.—For cases in point, see Cent. Dig. vol. 42, Removal of Causes, § 88.]

2. SAME—CONSTRUCTION OF STATUTE—"DEFENDANT."

Where words in a statute have acquired through judicial interpretation a well-understood meaning, it is assumed that such meaning was intended in subsequent statutes on the same subject; and the word "defendant," as used in the earlier removal acts, having been construed by the Supreme Court to include only a party who was a defendant on the record in the state court, it must be given the same construction as used in Act March 3, 1875, c. 137, § 2, 18 Stat. 470, as amended by Act March 3, 1887, c. 373, § 1, 24 Stat. 552, and Act Aug. 13, 1888, c. 866, § 1, 25 Stat. 433 (U. S. Comp. St. 1901, p. 509), which limits the right of removal to the "defendant or defendants."

[Ed. Note.—For cases in point, see Cent. Dig. vol. 42, Removal of Causes, § 88.]

For other definitions, see Words and Phrases, vol. 2, pp. 1936-1938.]

On Motion to Remand to State Court.

Trabue, Doolan & Cox, for plaintiff.

Clay & Clay, for defendants.

EVANS, District Judge. The plaintiff, the railroad company, brought this action against the defendants in the state court to recover \$66 alleged to be owing for freight cars furnished to defendants for the transportation of merchandise. The defendants filed an answer wherein, among other matters, they pleaded a counterclaim for \$3,000 for damages resulting from an alleged breach of a contract respecting the furnishing of cars. In due season the plaintiff filed its petition and bond, and removed the case to this court upon the ground of diverse citizenship alone, and the defendants have moved to remand it to the state court.

The single question involved has been ably argued, and the court has given much time to its consideration. As already pointed out, the claim of the plaintiff is for \$66, and the amount in controversy reached a sum exceeding \$2,000 when the defendants in their answer pleaded their counterclaim, and not before. The defendants are citizens of Kentucky, and therefore would not, in any event, have the right to remove the case. The plaintiff is a citizen of Illinois, and, having itself brought the action in the state court, could not remove it unless the pleading by the defendants of their counterclaim for \$3,000 per se brought the case within the removal statute as being, in effect, the institution of a new and independent suit by the defendants as plaintiffs against the railroad company as defendant.

Upon the question thus raised the decisions of the courts are in direct conflict. Removals in similar cases have been upheld in carefully considered opinions by Judge Trieber in *Price & Hart v. T. J. Ellis Co.* (C. C.) 129 Fed. 482, by Judge Hawley in *Walcott v. Watson* (C. C.) 46 Fed. 529 (where, however, the removal was under the local prejudice clause), by Judge Thayer in *Carson & Rand Lumber Co. v. Holtzclaw* (C. C.) 39 Fed. 578, and by Judge Blatchford in *Clarkson v. Manson* (C. C.) 4 Fed. 257. On the contrary, the right to remove has been quite as explicitly denied in equally able opinions by the Circuit Court of Appeals of the Fifth Circuit in *Waco Hardware Co. v. Michigan Stove Co.*, 91 Fed. 289, 33 C. C. A. 511, by Judge Jenkins in *La Montague v. T. W. Harvey Lumber Co.* (C. C.) 44 Fed. 645, by Judge Rogers in *McKown v. Kansas & T. Coal Co.* (C. C.) 105 Fed. 657, and by Judge Treat in *Falls Wire Co. v. Broderick* (C. C.) 6 Fed. 654. This court, in 1905, in the case of *McClellan v. Troendle*, ruled in accordance with the views expressed in the last-named cases in an unreported opinion; but as it would not hesitate to retract that opinion, if convinced of its incorrectness, it has very fully re-examined the question in all its bearings. As will be observed, we have not included in either list of cases *West v. City of Aurora*, 6 Wall. 139, 18 L. Ed. 819, which was quoted in nearly or quite all of the opinions referred to, but it will be particularly examined further along.

The learned counsel for the railroad company, in support of the right of removal, not only relies upon the line of authorities we first noted, and especially upon the case of *Price & Hart v. T. J. Ellis Co.* (C. C.) 129 Fed. 482, but urges, first, that, as its claim was only for \$66, the plaintiff was bound to sue in the state court, and should not be charged with the results of any voluntary choice of tribunals, because it had no option in the selection of a court; and, second, that when the counterclaim for \$3,000 was filed the plaintiff at once became the defendant in a new action in which there is a controversy involving a sum or value exceeding \$2,000, and this contention is fully sustained by the authorities cited in its support. But as an equal weight of authority, to say the least, is found upon the other side, including a ruling by the Circuit Court of Appeals of the Fifth Circuit, some further examination may not be inappropriate.

Looking at the language of the statute, apart from the decided cases, we find that the only ground for removal applicable to such a case is

diversity of citizenship—a ground for removal which is made available to a “defendant or defendants” only, and not to them except when an amount exceeding \$2,000 is in dispute. Those provisions are embraced in sections 1, 2, and 3 of the judiciary act of 1887 (Act March 3, 1887, c. 373, 24 Stat. 552, as amended by Act Aug. 13, 1888, c. 866, 25 Stat. 433 [U. S. Comp. St. 1901, pp. 508–510]), which, in substance, provide that the Circuit Courts of the United States, concurrently with the courts of the several states, shall have jurisdiction of all suits of a civil nature where the matter in dispute, exclusive of interest and costs, shall exceed the sum or value of \$2,000, and wherein there shall be a controversy between citizens of different states, and that such an action, if brought in a state court, may be removed “by the defendant or defendants therein, being nonresidents” of the state, to the Circuit Court of the United States for the proper district, upon filing a petition and giving bond at any time before the defendant is required to answer in the case under the law and practice of the state. Whether the actual plaintiff in the suit can be transmuted into a defendant, within the meaning of the statute, by the filing of an answer and counterclaim under the Kentucky Code of Practice is the question upon which the decision of the motion to remand must turn. It is one of statutory interpretation, and in its solution we must be governed by established rules, while bearing in mind that the prime object always is to ascertain the legislative intent—an intent which is to be found, if possible, in the language used.

Amidst the conflicting views of the courts, the right of a plaintiff to remove such cases has always been upheld, where upheld at all, upon the ground that by pleading a counterclaim the actual defendant thereby as to such claim potentially converted the actual plaintiff into a defendant. In a certain sense this may be correct, but whether Congress, in the language employed in its legislation on the subject, so intended, may admit of grave doubt. That language is explicit, and is that the case may be removed “by the defendant or defendants therein, being nonresidents,” where, as here, the ground therefor is diversity of citizenship. Whether that language should embrace a case like this must depend upon whether the Congress of 1887 so intended. In an effort to ascertain whether that Congress did so intend, it may be helpful to recall certain opinions of the Supreme Court in somewhat analogous cases. In *United States v. Union Pacific Railroad*, 91 U. S. 81, 23 L. Ed. 224, the court said:

“Congress acted with reference to a state of things believed at the time to exist; and, in interpreting its legislation, no aid can be derived from subsequent events.”

In *Platt v. Union Pacific R. R.*, 99 U. S. 63, 64, 25 L. Ed. 424, it was said:

“There is always a tendency to construe statutes in the light in which they appear when the construction is given. * * * But, in endeavoring to ascertain what the Congress of 1862 intended, we must, so far as possible, place ourselves in the light that Congress enjoyed, look at things as they appeared to it, and discover its purpose in the language used in connection with the attending circumstances.”

See, also, to the same effect *Mobile, etc., R. R. v. Tennessee*, 153 U. S. 552, 14 Sup. Ct. 968, 38 L. Ed. 793, and *Smith v. Townsend*, 148 U. S. 495, 13 Sup. Ct. 634, 37 L. Ed. 533.

Indeed, the general proposition is well established that, in order to ascertain the intent of Congress, it is entirely admissible to look at the conditions surrounding the subject-matter of any legislation at the time of its enactment. Fifty years ago most of the states then in the Union had adopted Codes of Practice which more or less radically changed the common-law forms and modes of procedure. Other states as they were admitted doubtless did the same thing. Probably, and we think certainly, all of these Codes authorized a defendant in an action to seek counter relief against the plaintiff in the latter's own suit, instead of having to resort to an independent proceeding. None of the older Codes, so far as we can ascertain, in terms authorized the courts to construe the word "plaintiff" as meaning "defendant" when counter relief was sought by the actual defendant by his answer in the case. This was a much more modern invention. We are not advised that any of the Codes had such a provision previous to 1867, when the Supreme Court decided the case presently to be mentioned, nor are we advised that such a provision became general before the passage of the judiciary act of 1887, if, indeed, it has ever become so. We strongly incline to think, however, the case may now be that such a provision was a rare exception, and not the rule, in 1887. While in certain special proceedings authorized in this state, such as those by corporations to condemn lands (under consideration in *Madisonville Traction Co. v. St. Bernard Mining Co.* [C. C.] 130 Fed. 789), those respecting forcible entry and detainer, and those relating to distress for rent, other provisions apply, plenary actions of a more formal character are governed by certain prescribed rules, among which are those now to be noted.

Section 110 of the Civil Code of Practice refers to the caption of a pleading, and requires it to show the names of the parties and a designation of who are plaintiffs and who defendants; section 95 permits a defendant in his answer to plead a counterclaim or set-off against the plaintiff; stated generally, section 96 defines both a counterclaim and a set-off to be a demand made by the defendant against the plaintiff; section 97, subsec. 2, provides that no summons is necessary upon a counter demand thus pleaded; and section 372 provides that a dismissal of the original suit by the plaintiff shall not prevent the trial of the case on the counter demand of the defendant. Substantially the same general provisions had appeared in all the Kentucky Codes since 1857; but the revision which went into effect in 1877 in the chapter on the construction of its provisions contains section 732, subsec. 36, which is as follows, viz.:

"The word 'plaintiff' embraces a defendant who demands a set-off or counterclaim; the word 'defendant' embraces a plaintiff against whom such demand is made; and the word 'petition' embraces an answer or reply in which such demand is made, and also embraces cross-petitions."

This was the earliest appearance of that provision, or anything like it, in a Kentucky Code, and the plaintiff here now mainly relies upon

this special clause in that Code as bringing this case within the general language of the judiciary act of 1887. But did Congress contemplate or intend that the language it used should be construed according to its natural import, or did Congress intend that its meaning might be altered or affected by the legislation of other jurisdictions enacted without congressional consent? It seems to the court to be entirely clear that the language used by Congress must be construed according to its natural import. The natural import of the words "defendant or defendants" includes those persons only who, upon the record, are actually and not merely constructively such, as distinguished from the actors or plaintiffs therein, and the court is of opinion that Congress did not authorize the courts to change that import from time to time in order to meet the fluctuations of state rules for the construction and definition of words used in their respective Codes of Practice. We think this proposition is incontrovertible and of itself decisive of the case. The legislation of Congress was fixed when enacted, and could not be changed, directly or indirectly, by any power except its own.

But there are other propositions equally cogent. So far as the cases we have cited give any indication, the other states in which they arose had Code provisions analogous to those of Kentucky in the Code it enacted before 1877, and we must assume that Congress was perfectly aware of the almost, if not quite, universal rule of the states to permit an actual defendant, when sued, not only to plead to the merits of the plaintiff's claim, but also to set up counter demands in his own favor. But, though Congress well knew of these laws of the states, it has never in any removal act in terms extended the right of removal to a plaintiff in whose suit a defendant interposed an answer setting up a counter demand for any sort of positive relief in his own favor against the actual and original plaintiff. The failure of Congress to change the language of the earlier removal act in this respect is all the more significant when we consider the opinion of the Supreme Court delivered in 1867 in the case of *West v. City of Aurora*, 6 Wall. 139, 18 L. Ed. 819. Under the law and practice of the state of Indiana the defendant, a citizen of that state, asked affirmative relief against plaintiffs, who, though citizens of Ohio, had instituted their action in the state court. Acting upon the assumption that the defendant had thus converted the plaintiffs into defendants, the plaintiffs removed the case to the federal court, and the motion of the defendant to remand it was sustained. In all essential respects the question there raised seems to have been precisely analogous to the one now before the court, inasmuch as under the removal act then in force only a "defendant" could remove upon the ground of diverse citizenship. The Supreme Court, through Mr. Chief Justice Waite, in affirming the lower court, said:

"We think the Circuit Court was clearly right in its action. The filing of the additional paragraphs did not make a new suit within the meaning of the judiciary act. They were in the nature of defensive pleas, coupled with a prayer for an injunction and general relief. This, if allowed by the Code of Indiana, might give them, in some sense, the character of an original suit, but not such as could be removed from the jurisdiction of the state court.

The right of removal is given only to a defendant who has not submitted himself to that jurisdiction; not to an original plaintiff in a state court who, by resorting to that jurisdiction, has become liable under the state laws to a cross-action. * * * In the case before us West and Torrance, citizens of Ohio, voluntarily resorted, as plaintiffs, to the state court of Indiana. They were bound to know of what rights the defendants to their suit might avail themselves under the Code. Submitting themselves to the jurisdiction, they submitted themselves to it in its whole extent. The filing of the new paragraphs, therefore, could not make them defendants to a suit removable on their application to the Circuit Court of the United States. * * * A suit removable from a state court must be a suit commenced by a citizen of the state in which the suit is brought, by process served upon a defendant who is a citizen of another state, and who, if he does not elect to remove, is bound to submit to the jurisdiction of the state court."

The twelfth section of the judiciary act of 1789 (Act Sept. 24, 1789, c. 20, 1 Stat. p. 79) provided for a removal by the "defendant," and the question to be determined by the Supreme Court was not when the removal should be made, but whether a plaintiff, when counter relief was asked by his opponent, could be regarded, theoretically or constructively, as a defendant in his own suit, and we do not doubt that the second syllabus of the report in the case accurately expresses the exact effect of the court's ruling when it says that:

"No removal can be made of a defense or answer, though of such a character as that, under a statute of the state, it becomes, by a discontinuance of the original suit itself, a proceeding that may go on to trial and judgment as if in some sense an original suit."

These propositions all appear to the court to be as perfectly applicable to the statute now in force as they were to that in force in 1867. At all events, Congress, with that opinion before it which explicitly denied to the plaintiff the right to remove such a case, and which put a definitive limitation upon the word "defendant" as used in section 12 of the original judiciary act, deliberately declined to change or broaden the language so construed. By using substantially the same language as that which had thus been interpreted, Congress, in the act of 1887 and amendments thereto, emphasized the legislative intent that a plaintiff in a suit should not, by construction, be regarded as a defendant when, in a suit of his own filed in a state court, his opponent under the state practice turned upon him with a prayer for independent and affirmative relief in plaintiff's suit, instead of a separate action. Nor can we doubt that the Supreme Court, in *West v. City of Aurora*, meant to lay down the general proposition that the word "defendant," used in the judiciary act, did not include, and was not meant by Congress to include, any person except actual and technical defendants, who are such on the record, as distinguished from the actor or plaintiff therein.

Unless we disregard these indicia of legislative intent, we cannot conclude that the act of 1887, in the use of the words "defendant or defendants," should have a different meaning from that of the act of 1789 in respect to the character of the party to whom the right of removal is given. The essential proposition, established by the Supreme Court and acquiesced in by Congress, is that when a plaintiff sues in a state court he cannot, upon the mere ground of diverse citizenship,

remove his suit to the federal court when the defendant thus sued by him avails himself of the right to seek in that suit a claim to counter relief of an independent and affirmative character. Full effect should be given to the natural meaning of words used in a legislative enactment, unless there are indisputable grounds for the conclusion that the legislative body did not so intend in the particular instance. Here the use of substantially the same word as that previously interpreted by the Supreme Court unmistakably manifests the congressional intent. The general proposition is well established that, where words in a statute have acquired through judicial interpretation a well-understood meaning, it is assumed that that meaning was intended in subsequent statutes on the same subject. *The Abbotsford*, 98 U. S. 444, 25 L. Ed. 168. See, also, *White-Smith Co. v. Apollo Co.*, 209 U. S. 14, 28 Sup. Ct. 319, 52 L. Ed. 655.

Upon these considerations, and in view of the judicial interpretation of the previous act, we have reached the conclusion that Congress intended to give the right of removal upon the ground of diverse citizenship to those persons only who were defendants in the plaintiff's suit, and not to an actual plaintiff, even though affirmative relief against him in the suit might be claimed by way of counter demand. Consequently we hold that the plaintiff here had no right to remove the case.

The motion to remand must be sustained.

PYMAN S. S. CO., Limited, v. ONE HUNDRED TONS OF KAINIT.

(District Court, S. D. Georgia, E. D. July 27, 1908.)

SHIPPING—DEMURRAGE—"WEATHER WORKING DAY."

Under a charter party for carriage of a cargo for delivery at Savannah, providing that the vessel should be discharged at the rate of 300 tons a "weather working day," where during the discharge it rained shortly before noon and nothing further was done that day, the cargo being of a character which would be injured by being wet, the charterer was entitled to the deduction of such day from the lay days, under the rule of the Savannah Board of Trade, following an old established custom of the port, providing that rain during working hours previous to noon shall prevent that day from counting.

[Ed. Note.—For cases in point, see Cent. Dig. vol. 44, Shipping, § 590.

For other definitions, see Words and Phrases, vol. 8, p. 7426.

Demurrage, see notes to *Harrison v. Smith*, 14 C. C. A. 657; *Randall v. Sprague*, 21 C. C. A. 337; *Hagerman v. Norton*, 46 C. C. A. 4.]

In Admiralty. Suit in rem for demurrage.

William R. Leaken, for libellant.

William W. Gordon, Jr., and Daniel Charlton, for claimant.

SPEER, District Judge. The Pyman Steamship Company, Limited, of West Hartlepool, England, is the owner of the British steamship *Winifred*. In a voyage from Hamburg to Savannah a part of the cargo was 100 tons of kainit. The charterer for this voyage was the

Hamburg-Amerikanische Packetfahrt Aktien Gesellschaft. The Winifred arrived at Savannah on the 6th of October, 1906, was entered at the custom house, and gave due notice of her readiness to discharge. Sunday intervening, the lay days of the ship began on Monday, the 8th, and on that date the charterer's agents, to wit, the Southern Shipping Company, and the owner of the kainit, the Southern States Phosphate & Fertilizer Company, proceeded to discharge the vessel. There is no complaint of any unlawful delay in this work until October 17th. On that day the steamship company claims that the charterer's agents and the owner of the kainit, at or about 11:30 a. m., ceased work, and did not, as they were bound to, complete the discharge of the stipulated average of 300 tons of cargo per weather working day, as per charter party and bill of lading. This cessation took place, in the language of the libel, "upon the completion of hold No. 4," by which we may presume that the pleader intended, when the unloading of hold No. 4 was "completed." For this half day demurrage is claimed. It is also claimed that the unloading of the cargo should have been completed by noon of the 23d day of October, and that at that time demurrage began to accumulate. The ship was not fully discharged, however, until the end of the 24th. For these delays, which are alleged to be unlawful, the Pyman Steamship Company claims the sum of \$350 by way of demurrage, and has brought its libel therefor.

The clause of the charter party upon which the libellant relies is as follows:

"The steamer to be discharged at port of discharge at not less than an average of 300 tons a weather working day. If detained longer, demurrage to be paid 4 pence British sterling per ton gross register for every day so detained."

The gross tonnage of the Winifred was 2,794 tons. The clause in the charter party authorizing the lien in admiralty is as follows:

"Steamer to have an absolute lien upon the cargo for all freight, dead freight, and demurrage."

There is no dispute as to the dereliction of the respondent on the last day for unloading, viz., October 24th. It should have discharged the cargo by noon. It did not do this until the end of the day. It concedes that the libellant is entitled to recover for a half day's demurrage. The controversy rages as to the demurrage claimed on October 17th. There is no dispute that the work of discharging the cargo stopped anywhere from 11:30 to 12 o'clock on that day. The respondent, however, justifies this hiatus in the energies of its employes by reference to a provision of the Savannah Board of Trade, designed and formulated for the exigencies of that port. The rule is thus tersely stated:

"Rain during working hours previous to noon shall prevent that day from counting. Rain after noon previous to 4 p. m. shall prevent that half of the day from counting."

Now, the charter party does not undertake to define a "weather working day," or, in the meaning of the rule of the Savannah Board of Trade, a day the loss of which would count in the accumulation of

demurrage. The Circuit Court of Appeals of the Fifth Circuit, in the case of *The India*, 49 Fed. 76, 1 C. C. A. 174, has afforded a clear and practical definition:

"A day, otherwise a working day, when the weather would reasonably permit the carrying on of the work contemplated."

Considering this definition in connection with the facts of the case, we do not feel obliged to express an opinion as to the validity of the somewhat indulgent rule of the Savannah Board of Trade, above quoted. It is sufficient to say that the rule itself was not adopted to cause delay in loading or unloading the vessels engaged in the large commerce of that important port. It is more likely ascribable to the astonishing celerity with which the American citizens of African descent, who form a vast majority of the laborers along the wharves in Savannah, will disperse and disappear in the presence of a shower, and after such dispersal the impossibility of such a rally or assembly as would enable the stevedores to resume the work of discharging. Some of the witnesses testified to this reason for the rule. That it is well grounded upon fact will be recognized by all who know how easily the gravest responsibilities of life are cheerfully thrown aside by this light-hearted class of our population. According to the testimony of Mr. W. B. Stillwell, the president of the Savannah Board of Trade, of the secretary and other officers of the respondent, and of witnesses wholly disinterested, a custom similar to that prescribed by the Board of Trade has long existed in Savannah. It is that where any rain falls before the hour of 12, upon the option of the party interested the day will not count as a lay day, but it is held a nonweather working day. Certainly this was as well understood by the longshoremen and stevedores as by the shipping merchants of Savannah. There was no evidence to contradict the universality of this custom of the port, and, while it may not be held applicable to all cases, we may consider it along with the circumstances of this case, in order to ascertain whether or not the 17th is to be treated as a weather working day.

In the same connection we consider the character of the cargo being discharged. It consisted of manure salt and kainit, known as potash salts. It appears that these salts when dry are easily handled, but when wet have a tendency to dissolve and waste, and after being subjected to moisture, when they dry, the remnant hardens or solidifies to such an extent that it is frequently necessary to use dynamite in order to break up the mass so that it can be handled. For this reason it is contended by the respondent that it was improper to discharge this cargo in rainy weather. It insists that the 17th day of October, for which one-half day's demurrage was obtained, was rainy in the morning.

As usual in such cases, there is much evidence on both sides as to the fact of rain. The officers of this vessel and other vessels testified that there was no rain. For the respondent many witnesses have sworn that it was actually raining before the noon hour. Mr. T. Newell West, the acting stevedore for the Southern States Phosphate

& Fertilizer Company, who superintended the unloading of the Wini-fred, testified:

"I did not take the hatch off. About 9 a. m. I started to haul the ship. It took half or a hour to haul her, and about 10 or 10:30, I think, it was finished, and it was raining so I knocked the men off."

He said many drops were actually falling at that time.

Mr. F. D. Screven, superintendent of the respondent's works, testified:

"I got down about half-past 10, and, immediately on getting there, it was raining then. So I put on a rain coat and took an umbrella, and kept it up until I got to the wharf, * * * and when I got there Mr. West was opening No. 3 hatch—just finished No. 4—and I gave instructions to stop work on account of the weather conditions."

The libelant's witnesses admit that it was misty and the sky was overcast. In the presence of this conflicting evidence the court prefers to accept the official report of the Weather Bureau at Savannah. The operator, Mr. H. B. Boyer, reports that the prevailing conditions were as follows:

"Cloudy and overcast all day, except between the hours of 12 noon and 1 p. m., when the sun shone for short periods. Misting rain began some time during the very early morning, and continued until 11:20 a. m."

Another cogent piece of testimony is a letter of Mr. Screven, written the day after that in question, viz., the 18th. It was addressed to the captain of the vessel. He wrote:

"In view of the fact that we made every reasonable effort to continue work on your vessel, but were forced to discontinue work due to rain in the forenoon, I do not agree with you that yesterday was a weather working day, nor do I agree with you that you can count it as a lay day."

This indicates clearly that the defense of the respondent was not the result of device or forethought. Otherwise, they exercised all reasonable diligence. To expedite the unloading of the vessel, they even, in violation of the laws of Georgia, worked on the 14th and the 21st, which were Sundays, when it was entirely optional with them whether they would work or not, so far as the rights of the chartered party were concerned.

For these reasons, I conclude that the libelant has not made out a case for demurrage so far as it relates to the claim for the 17th of October. The respondent admitting liability for one-half day of demurrage, in the amount of \$112.69, this will be allowed. This sum was tendered to the libelant, but not until the libel was filed. Judgment, therefore, will be rendered for the libelant in the sum of \$112.69, with costs of the case.

In re RIONDA.

(District Court, S. D. New York. June 16, 1908.)

ALIEN—PERSONS WHO MAY BECOME CITIZENS BY NATURALIZATION—ALIEN WIFE OF FOREIGNER.

An alien woman, married to an alien, although residing in this country and otherwise qualified, cannot become a citizen of the United States by naturalization.

[Ed. Note.—For cases in point, see Cent. Dig. vol. 2, Aliens, § 122.]

Petition for Naturalization.

Henry L. Stimson and Hugh Govern, Jr., for the United States.
William Y. Clarke, for petitioner.

ADAMS, District judge. The petitioner, Harriet Rionda, seeks to become a citizen of this country by naturalization. It appears that she was born in the Kingdom of Great Britain and Ireland. In 1889, she was married in this country to her present husband, Manuel Rionda, then, and now, a subject of the King of Spain. She admits that her husband has no intention of applying for American citizenship.

The question is whether an alien woman dwelling in this country and otherwise qualified, can, in the circumstances mentioned, be naturalized under our laws.

The decisions upon the subject have not been uniform, but the weight of authority establishes that the nationality of a wife is controlled by that of her husband. The subject has been discussed and the various decisions collected in Van Dyne on Naturalization, 51-53, inclusive.

It is explicitly provided by the United States laws:

"Sec. 3. That any American woman who marries a foreigner shall take the nationality of her husband. At the termination of the marital relation she may resume her American citizenship, if abroad, by registering as an American citizen within one year with a consul of the United States, or by returning to reside in the United States, or, if residing in the United States at the termination of the marital relation, by continuing to reside therein." Act March 2, 1907, c. 2534, 34 Stat. 1228 (U. S. Comp. St. Supp. 1907, p. 381).

If, therefore, the applicant had been an American woman, she would have taken the nationality of her foreign husband, and it is difficult to see how a foreign born married woman is in a position to acquire the rights given by naturalization.

The application must be denied.

KELLEY et al. v. McNAMEE.

(Circuit Court of Appeals, Ninth Circuit. October 5, 1908.)

No. 1,573.

MINES AND MINERALS (§ 99*) — MINING PARTNERSHIPS — LIABILITY OF RETIRING PARTNER.

A mining partnership, unlike an ordinary one, is not dissolved by the sale of the interest of one of the partners; but whether the retiring partner is liable for indebtedness of the partnership subsequently incurred depends on the facts of the case. As to employes who continue in the employment after the change, without knowledge thereof, his liability continues, but not for subsequent wages, if they know of the transfer.

[Ed. Note.—For other cases, see Mines and Minerals, Dec. Dig. § 99.*

Mining partnerships, see note to *G. V. B. Min. Co. v. First Nat. Bank of Hailey*, 35 C. C. A. 515.]

In Error to the District Court of the United States for the Third Division of the District of Alaska.

McGowan & Clark and C. W. Miller, for plaintiffs in error.

T. C. West, Fernand De Journal, and Henry Roden, for defendant in error.

Before GILBERT, ROSS, and MORROW, Circuit Judges.

ROSS, Circuit Judge. This action was commenced in the court below by the defendant in error to recover wages for work done by him and his assignors upon that certain placer mining claim known as "No. 3 Above Discovery on the Right Limits of First Tier of Benches on Dome Creek," in the Fairbanks mining district of Alaska. The case was tried by the court without a jury, on the stipulation of the respective parties, and resulted in findings of fact and a judgment in favor of the plaintiff to the action for the sum of \$8,563.50, with interest from May 1, 1907, and costs of suit. In so far as the findings have any evidence at all to support them, they are conclusive upon us; but if it be true, as is insisted on the part of the plaintiffs in error, that in some respects at least they are not only wholly unsupported by the evidence, but are in conflict with the uncontradicted evidence in certain respects, we are not so concluded.

The complaint contains 17 counts. In each count it is alleged that on and prior to October 9, 1906, the defendants were, and ever since have been, and now are, partners in the business of mining on Dome Creek. The first count also alleges that between the 15th and 28th days of April, 1907, the plaintiff performed 12 days' labor for the defendants as engineer on the placer mining claim mentioned, at the request of the defendants, for which they promised to pay him \$6 a day, no portion of which has been paid, and that there is now due and owing from the defendants to the plaintiff the sum of \$54. The second count alleges that between October 9, 1906, and the 21st of April, 1907, James O'Day performed 195 days' work for the defendants on the said mining claim, on which last-mentioned day, at the place mentioned, an account was stated between O'Day and the defendants, upon which

*For other cases see same topic & § NUMBER in Dec. & Am. Digs. 1907 to date, & Rep'r Indexes

statement a balance of \$689.15 was found due, which the defendants agreed to pay O'Day, but no part of which has been paid; that on the 6th day of May, 1907, O'Day duly assigned all his right in and to the account to the plaintiff. The third count alleges that between October 9, 1906, and April 26, 1907, A. C. Johnson performed 195 days' work for the defendants on the said mining claim, and that on or about April 25, 1907, at Dome Creek, an account was stated between him and the defendants, upon which statement a balance of \$938 was found due, which the defendants agreed to pay Johnson, but no part of which has been paid; that on the 6th day of May of the same year Johnson duly assigned all his right in and to said account to the plaintiff. The fourth count alleges that between October 9, 1906, and April 26, 1907, Frank Gustavson performed 195 days' work for the defendants on the mining claim mentioned, and that on or about April 25, 1907, at Dome Creek, an account was stated between him and the defendants, upon which statement a balance of \$823.15 was found due Gustavson, which the defendants agreed to pay, but no part of which has been paid; that on the 6th day of May, 1907, Gustavson duly assigned all his right in and to the account to the plaintiff. The fifth count alleges that between October 9, 1906, and April 25, 1907, Martin Nahtrin performed 195 days' work for the defendants on the mining claim mentioned, and that on or about the 25th day of April, 1907, at Dome Creek, an account was stated between him and the defendants, upon which statement a balance of \$706 was found due Nahtrin, which the defendants agreed to pay, but no part of which has been paid; that on the 6th day of May, 1907, Nahtrin duly assigned all his right in and to the account to the plaintiff. The sixth count alleges that between October 9, 1906, and April 25, 1907, C. J. Hall performed 171 days' labor for the defendants on the mining claim mentioned, and that on or about the 25th day of April, 1907, at Dome Creek, an account was stated between him and the defendants, upon which statement a balance of \$677.55 was found due Hall, which the defendants agreed to pay, but no part of which has been paid; that on the 6th day of May, 1907, Hall duly assigned all his right in and to the account to the plaintiff. The seventh count alleges that between January 8, 1907, and April 25, 1907, J. J. McDonald performed 108 days' work for the defendants on the mining claim mentioned, and that on or about the 25th day of April, 1907, at Dome Creek, an account was stated between him and the defendants, upon which statement a balance of \$360.25 was found due McDonald, which the defendants agreed to pay, but no part of which has been paid, that on the 6th day of May, 1907, McDonald duly assigned all his right in and to the account to the plaintiff. The eighth count alleges that between January 4, 1907, and the 25th day of April, 1907, Peter Wenn performed 112 days' work for the defendants on the mining claim mentioned, and that on or about the 25th day of April, 1907, at Dome Creek, an account was stated between him and the defendants, upon which statement a balance of \$327.50 was found due Wenn, which the defendants agreed to pay, but no part of which has been paid; that on the 6th day of May, 1907; Wenn duly assigned all his right in and to the account to the plaintiff. The ninth count alleges that between January 21, 1907, and April 15, 1907, Ed. Wilkinson performed 85 days'

work for the defendants on the mining claim mentioned, and that on or about the 25th day of April, 1907, at Dome Creek, an account was stated between him and the defendants, upon which statement a balance of \$515 was found due Wilkinson, which the defendants agreed to pay, but no part of which has been paid; that on the 6th day of May, 1907, Wilkinson duly assigned all his right in and to the account to the plaintiff. The tenth count alleges that between January 21, 1907, and April 7, 1907, Edward Olsen performed 87 days' work for the defendants on the mining claim mentioned, and that on or about the 7th day of April, 1907, at Dome Creek, an account was stated between him and the defendants, upon which statement a balance of \$349.50 was found due Olsen, which the defendants agreed to pay, but no part of which has been paid; that on the 6th day of May, 1907, Olsen duly assigned all his right in and to the account to the plaintiff. The eleventh count alleges that between December 5, 1906, and April 25, 1907, C. Knutson performed 142 days' work for the defendants on the mining claim mentioned, and that on or about the 25th day of April, 1907, at Dome Creek, an account was stated between him and the defendants, upon which statement a balance of \$500.50 was found due Knutson, which the defendants agreed to pay, but no part of which has been paid; that on the 6th day of May, 1907, Knutson duly assigned all his right in and to the account to the plaintiff. The twelfth count alleges that between October 9, 1906, and April 25, 1907, Max Nelson performed 195 days' labor for the defendants on the mining claim mentioned, and that on or about the 25th day of April, 1907, at Dome Creek, an account was stated between him and the defendants, upon which statement a balance of \$729.35 was found due Nelson, which the defendants agreed to pay, but no part of which has been paid; that on the 6th day of May, 1907, Nelson duly assigned all his right in and to the account to the plaintiff. The thirteenth count alleges that between the 9th day of December, 1906, and the 25th day of April, 1907, Jack Dugan performed 138 days' labor for the defendants on the mining claim mentioned, and that on or about the 25th day of April, 1907, at Dome Creek, an account was stated between him and the defendants, upon which statement a balance of \$647.75 was found due Dugan, which the defendants agreed to pay, but no part of which has been paid; that on the 6th day of May, 1907, Dugan duly assigned all his right in and to the account to the plaintiff. The fourteenth count alleges that between October 18, 1906, and April 25, 1907, C. E. Allen performed 191 days' labor for the defendants on the mining claim mentioned, and that on or about April 25, 1907, at Dome Creek, an account was stated between him and the defendants, upon which statement a balance of \$651.10 was found due Allen, which the defendants agreed to pay, but no part of which has been paid; that on the 6th day of May, 1907, Allen duly assigned all his right in and to the account to the plaintiff. The fifteenth count alleges that between March 17, 1907, and April 25, 1907, Chris Nerland performed 41 days' labor for the defendants on the mining claim mentioned, and that on or about April 26, 1907, at Dome Creek, an account was stated between him and the defendants, upon which statement a balance of \$157 was found due Nerland, which the defendants agreed to pay, but no part of which has

been paid; that on May 6, 1907, Nerland duly assigned all his right in and to the account to the plaintiff. The sixteenth count alleges that between March 2, 1907, and April 26, 1907, Thomas Taralson performed 55 days' labor for the defendants on the mining claim mentioned, and that on or about April 26, 1907, at Dome Creek, an account was stated between him and the defendants, upon which statement a balance of \$207.50 was found due Taralson, which the defendants agreed to pay, but no part of which has been paid; that on May 6, 1907, Taralson duly assigned all his right in and to the account to the plaintiff. The seventeenth count alleges that between March 2, 1907, and May 5, 1907, M. Wakkila performed 50 days' labor for the defendants on the mining claim mentioned, and that on or about May 5, 1907, at Dome Creek, an account was stated between him and the defendants, upon which statement a balance of \$237.80 was found due Wakkila, which the defendants agreed to pay, but no part of which has been paid; that on May 6, 1907, Wakkila duly assigned all his right in and to the account to the plaintiff.

The defendants filed a joint amended answer, in which is a denial of all of the allegations of the first count of the complaint, coupled, however, with an express admission that the defendants have not paid the plaintiff any sum of money whatever. The amended answer then sets up that there is a misjoinder of parties defendant in the action, in that, at the time of the alleged performance of labor by the plaintiff, the defendant Kelley had no interest in the said property and was not a member of the partnership alleged in the complaint. In answer to the second cause of action counted on, the amended answer denies all of its allegations, except the assignment to the plaintiff, and expressly admits that the defendants have not paid the plaintiff any money. It also sets up a misjoinder of parties defendant in the second count, in that Williams is improperly made a party defendant in that cause of action for the reason that he owned no interest in the mining claim at any time prior to December 20, 1906, and that Kelley is improperly joined in that cause of action for the reason that he had no interest in the said property or in the work being prosecuted thereon subsequent to December 20, 1906. The amended answer contains similar denials, admissions, and alleged misjoinders in respect to each of the other counts of the complaint.

Subsequently the defendants asked leave of the court to file a "separate and supplemental answer and counterclaim," in which it was alleged that the plaintiff and his assignors were at all of the times mentioned in the complaint employed as laborers on the placer mining claim mentioned, and that the terms of such employment were that they should receive their pay for such labor "after the dump of gold-bearing gravel taken out between the months of October, 1906, and the 1st day of May, 1907, and piled upon said claim, had been washed and sluiced up in the spring of 1907"; that on or about May 1, 1907, the plaintiff and his said assignors wrongfully, unlawfully, and fraudulently conspired together to prevent any of the defendants from washing up the said dump, "which said dump had been theretofore, during the period of the said plaintiff's and his assignors' employment, extracted from said mining claim," and that the plaintiff and his said as-

signors did at the time last stated "enter upon and incite a strike against defendants and their successors in interest, and all of them, and did then and there, contrary to the terms of their employment, leave the employ of defendants, and each of them, and then and there refuse to wash up said dump, or any part thereof, and by threats, intimidation, and coercion prevented other laborers from washing or sluicing the dump during the spring of 1907; that it is customary in the Fairbanks mining district, and particularly on Dome Creek, to use the snow water as it melts for washing up the winter dumps, and that by the alleged acts of the plaintiff and his assignors the defendants were prevented from doing so, and that by reason of the inability of the defendants to secure the gold in the dumps in the early spring, "at which time all of its obligations fell due, and at which time defendants were obligated to pay all bills for supplies and labor contracted during the winter, defendants were involved in a vast amount of litigation and were put to great and unnecessary expense in defending the same, and greatly embarrassed in the carrying on of their business, and damaged to the extent of \$20,000," which damage was caused entirely by the alleged acts of the plaintiff and his said assignors. The prayer of this pleading was that plaintiff take nothing by his action, and that the defendants have judgment against him and his assignors in the sum of \$20,000. The court below refused to permit the filing of the supplemental answer and counterclaim, to which action the defendants excepted, and here assign the ruling as error.

The defendant Williams also subsequently asked leave to file a separate answer, containing denials, admissions, and allegations similar to those contained in the other pleadings on the part of the defendants already mentioned, and also denying, upon information and belief, the alleged assignments to the plaintiff. The court below likewise refused to permit this last-mentioned answer to be filed, to which action of the court the defendant Williams excepted, and which ruling is also assigned as error.

On the trial there was introduced in evidence, on the part of the plaintiff, written articles of partnership "for the purpose of mining and working said mining claim," by and between the defendants Blondo, Broome, and Kelley, of date October 9, 1906, setting forth, among other things, the interest of each partner in the property and the proportions in which they should share in the proceeds. The evidence shows without conflict that Kelley sold all of his interest in the property to Williams on the 20th day of December, 1906, by the terms of which sale Williams assumed, among other things, the amount of Kelley's indebtedness to the miners then and theretofore working upon the claim, including some of the assignors of the plaintiff. The evidence further shows without conflict that such of the plaintiff's assignors as were working for the partnership prior to Kelley's sale to Williams continued working for the partnership after Williams succeeded to Kelley's interest, and that the plaintiff and the others of his assignors commenced working for the partnership subsequent to Kelley's sale to Williams.

The court below found the number of days that the plaintiff and each of his assignors worked upon the claim in question, the agreed rate of wages of each, the dates within which each of them worked, the amount of money earned by each of the miners at the agreed rate, that none of them had been paid, that the various alleged assignments were actually made to the plaintiff, and further found as a fact "that at all the times mentioned in plaintiff's complaint the defendants were mining copartners engaged in mining upon Placer Mining Claim No. 3 Above Discovery First Tier Right Limit of Dome Creek, Fairbanks Mining and Recording District, Territory of Alaska," and from the findings so made concluded as matter of law that all of the defendants are indebted to the plaintiff in the sum sued for, and gave judgment accordingly.

The finding to the effect that at all the times mentioned in the complaint the defendants were mining copartners, engaged in mining upon the placer claim in question, evidently proceeded upon the view of the law relating to mining partners expressed by the court in ruling upon a motion made during the course of the trial, as follows:

"A mining partnership differs in many respects from an ordinary partnership. Where three men go into a mercantile partnership, for instance, and one sells out, it is a dissolution of partnership under the rules of law. If he dies, it is a dissolution of the partnership. If one withdraws through bankruptcy, or for any other reason, from the partnership, it is a dissolution of the partnership; or if one sells out or retires in any way. But that is not true in a mining partnership. Where three men become mining partners, the partnership is not dissolved where one sells out and another man takes his place. The partnership goes right along. If one should die and his interest be sold out, another person may purchase that interest and become a partner; and he becomes a partner in the partnership without regard to the consent of the other partners. If they proceed with the work of the partnership, it is an approval on behalf of the other partners; and the rules of law permit just such a thing as was done in this case to be done. Upon the sale, if there was a sale, by Mr. Kelley of his interest to Mr. Williams, and the entrance of Mr. Williams into the partnership, the partnership was not dissolved in any way. It went right on. So that, in those respects, and in many other respects, there are great differences between mining partnerships and other partnerships."

In some respects the learned judge was correct in those observations, but in others the inferences and conclusions drawn by him are not correct. It is quite true that a mining partnership, unlike an ordinary one, is not dissolved by the sale of the interest of one of the partners; but it does not follow, from the mere continuance of the partnership, that the mining partner selling his interest continues liable for all of the debts of the partnership subsequently incurred. Under certain circumstances he may continue liable for subsequently incurred indebtedness of the partnership, as, for instance, where, as in this case, the partnership is indebted to laborers for work done while the partner selling was a member of the partnership, and such laborers continue their work upon the property without notice of such sale. In the case of *Dellapiazza v. Foley*, 112 Cal. 380, 44 Pac. 727, the Supreme Court of that state held a mining partner, disposing of his interest in the mining partnership, bound by the provisions of section 2453 of the Civil Code of California, which enacts that the liability of a general partner for the acts of his copartners continues, after dissolution of the partner-

ship, in favor of persons who have had dealings with and given credit to the partnership until they have had personal notice of the dissolution, saying:

"The law governing general copartnerships, with a few well-defined exceptions, applies to mining copartnerships. Therefore, a mining copartner, who claims exemption from the general law of partnerships, must show his case to be within some one of those exceptions. This appellant has failed to do; and I see no just reason for excepting the case of appellant from the full operation and effect of the above-cited section of the Civil Code—it being a part of the general law of partnerships, and its application to this case not being inconsistent with any exception heretofore recognized in favor of mining partnerships. *Jones v. Clark*, 42 Cal. 180; *Stuart v. Adams*, 89 Cal. 367, 26 Pac. 970. As to the 'personal notice of the dissolution,' required by the Code section cited, see *Johnson v. Totten*, 3 Cal. 343, 58 Am. Dec. 412, and *Williams v. Bowers*, 15 Cal. 321, 76 Am. Dec. 489. The notice must have been actual. The deed to the corporation was not even constructive notice to plaintiff of the sale."

We have been cited to no similar statute of Alaska, but the general rule governing ordinary partnerships upon the point applies. As to the plaintiff and such of his assignors as commenced work for the partnership after Kelley had ceased to be a member of it by reason of the sale of all of his interest in the property to Williams, it is clear that there should not have been judgment against Kelley; for he was an utter stranger to them, never having had any contract relations with them in respect to the property. As to such of the plaintiff's assignors as had commenced to work for the partnership while Kelley was a member of it, and continued such work after his sale to Williams, but without notice of such sale, Kelley is clearly liable under the well-established rule applicable to all partnerships, which general rule, however, exempts him from liability to such of the plaintiff's assignors whose work commenced for the partnership while he was a member of it and thereafter continued, either with actual notice of such sale or with knowledge of such facts and circumstances as were sufficient to have put a reasonably prudent person on inquiry as to the sale. *Delapiazza v. Foley*, 112 Cal. 385, 44 Pac. 727; *Treadwell v. Wells*, 4 Cal. 260; *Davis v. Keyes*, 38 N. Y. 94; *Holtgreve v. Wintker*, 85 Ill. 472; *Smith v. Vanderburg*, 46 Ill. 34; *Zollar v. Janvrin*, 47 N. H. 328; *Young v. Tibbitts*, 32 Wis. 79.

The evidence shows without conflict that some of the plaintiff's assignors who were working on the claim at the time of Kelley's sale of his interest, and thereafter continued to work thereon, had actual notice of the sale; but the findings do not disclose which of such assignors had such actual notice or the equivalent thereof. We think the judgment right as to all of the other defendants, including Williams, who by the terms of his purchase from Kelley assumed the latter's proportion of the then existing indebtedness to the miners, and who was, of course, liable for the indebtedness thereafter incurred by the partnership.

The only assignment of error on behalf of Kelley individually is that:

"The court erred in failing to find, as a matter of fact, that defendant James Kelley was improperly joined as party defendant in said action."

That assignment is not well taken, for Kelley was unquestionably liable for the indebtedness incurred while he was a member of the partnership, and was, therefore, a proper party defendant. It is true that the court is authorized to take notice of and act on a plain error in the absence of an assignment; but in view of the nature of this case, that the defendant in error, possibly relying upon the assignments of error, has made no appearance here, the conditions prevailing in the territory where the cause arose, the fact that the judgment is right as to all of the parties except Kelley, right as to him in part, and cannot be changed, except by reversing the whole judgment and sending the case back to the court below for a new trial, we are of the opinion that the case is not a proper one for the exercise of our discretion to notice and act on a plain error not assigned.

The judgment is affirmed.

STANDARD OIL CO. OF INDIANA v. UNITED STATES.

(Circuit Court of Appeals, Seventh Circuit. July 22, 1908. On Rehearing, November 10, 1908.)

No. 1,409.

1. CARRIERS (§ 38*)—OBTAINING ILLEGAL CONCESSION—SHIPPER'S LIABILITY—LAWFUL RATES—KNOWLEDGE—EVIDENCE.

Under Elkins Act Feb. 19, 1903, c. 708, 32 Stat. 847, § 1 (U. S. Comp. St. Supp. 1907, p. 880), making it unlawful for any person or corporation to accept or receive any rebate, concession, or discrimination in respect to the transportation of any property in interstate or foreign commerce, and requiring the filing and publication of interstate rates, a shipper cannot be convicted of accepting a concession from the lawfully published rate without proof of knowledge of what such rate in fact was; and hence evidence that the shipper had no knowledge of the published rate, and could only have ascertained the same by construction of several tariff sheets, the application of which was questionable, was admissible.

[Ed. Note.—For other cases, see Carriers, Dec. Dig. § 38.*]

2. CARRIERS (§ 38*)—ILLEGAL CONCESSIONS—PROSECUTION OF SHIPPER—"TRANSACTION"—COMPLETED OFFENSE.

Elkins Act Feb. 19, 1903, c. 708, 32 Stat. 847, § 1 (U. S. Comp. St. Supp. 1907, p. 880), prohibits any person or corporation from receiving any rebate, concession, or discrimination in respect to the transportation of any property in interstate or foreign commerce, etc., and declares that every person or corporation who shall accept or receive any such rebates or concession shall be guilty of a misdemeanor, and on conviction be fined, etc. *Held*, that the gist of the offense was the receipt of a concession, irrespective of whether the property involved was train loads, car loads, or pounds, and consisted of the "transaction," which was not completed until the shipper received a rate different from the established rate, without reference to the size of the shipment.

[Ed. Note.—For other cases, see Carriers, Dec. Dig. § 38.*]

3. CARRIERS (§ 38*)—ILLEGAL CONCESSIONS—SENTENCE—ABUSE OF DISCRETION.

Defendant, Standard Oil Company of Indiana, was found guilty on 1,462 counts of an indictment for receiving concessions from a railroad company on shipments of oil, in violation of Elkins Act Feb. 19, 1903, c. 708, 32 Stat. 847, § 1 (U. S. Comp. St. Supp. 1907, p. 880). Defendant's capital stock was \$1,000,000, and there was no evidence that its assets

*For other cases see same topic & § NUMBER in Dec. & Am. Digs. 1907 to date, & Rep'r Indexes

were in excess of that sum, nor did it appear that defendant had ever before been guilty of a similar offense. A majority of defendant's capital stock was owned by the Standard Oil Company of New Jersey, which was no party to the prosecution, whose capital stock was \$100,000,000. This corporation was a holding company, and its net earnings for the period during which the concessions were received the court investigated before passing sentence. *Held*, that the assessment of the fine of \$29,240,000, which was the maximum punishment on each count, based on a finding that such amount was less than one-third of the net revenues of the Standard Oil Company of New Jersey during the period of violation, the effect of which would be to bankrupt the defendant, was excessive, and an abuse of discretion.

[Ed. Note.—For other cases, see Carriers, Dec. Dig. § 38.*]

In Error to the District Court of the United States for the Northern Division of the Northern District of Illinois.

For opinion below see 155 Fed. 305.

John S. Miller and Moritz Rosenthal, for plaintiff in error.

Edwin W. Sims, U. S. Dist. Atty., and James H. Wilkerson, Sp. Asst. U. S. Atty.

Before GROSSCUP, BAKER, and SEAMAN, Circuit Judges.

GROSSCUP, Circuit Judge. The writ of error is to the judgment and sentence of the District Court, fining plaintiff in error in the sum of twenty-nine million, two hundred and forty thousand dollars, upon a verdict of guilty upon 1,462 counts of an indictment, each charging plaintiff in error with having, on a date mentioned within the period from September 1, 1903, to March 1, 1905, unlawfully and knowingly accepted and received from the Chicago & Alton Railway Company a concession in respect of the transportation of certain property of plaintiff in error therein mentioned, in interstate commerce, whereby such property was transported, in such interstate commerce, at a rate less than that named in the tariffs published and filed by said Railway Company, as required by the act to regulate commerce and the acts amendatory thereof.

The indictment is based upon section 1 of the Act approved February 19, 1903 (32 Stat. 847, c. 708 [U. S. Comp. St. Supp. 1907, p. 880]), formerly known as the "Elkins Act," wherein it was provided:

"That it shall be unlawful for any person, persons or corporation, to offer, grant or give, or to solicit, accept or receive any rebate, concession or discrimination in respect of the transportation of any property in interstate or foreign commerce, * * * whereby any such property shall, by any device whatever, be transported at a less rate than that named in the tariffs published and filed by such carrier, as is required by said act to regulate commerce and the acts amendatory thereto, or whereby any other advantage is given, or discrimination is practiced. Every person or corporation who shall offer, grant, or give, or solicit, accept or receive, any such rebates, concession or discrimination, shall be deemed guilty of a misdemeanor, and on conviction thereof shall be punished by a fine of not less than one thousand dollars or more than twenty thousand."

The fine actually imposed, was the maximum penalty provided.

The provision of the interstate commerce act relating to the publishing and filing of rates is as follows:

*For other cases see same topic & § NUMBER in Dec. & Am. Digs. 1907 to date, & Rep'r Indexes

"Sec. 6. That every common carrier subject to the provisions of this act shall print and keep open to public inspection schedules showing the rates, and fares and charges for the transportation of passengers and property which any such common carrier has established and which are in force at the time upon its route. The schedules printed as aforesaid by any such common carrier shall plainly state the places upon its railroad between which property and passengers will be carried, and shall contain the classification of freight in force, and shall also state separately the terminal charges and any rules or regulations which in any wise change, affect, or determine any part or the aggregate of such aforesaid rates, fares and charges. Such schedules shall be plainly printed in large type and copies for the use of the public shall be posted in two public and conspicuous places in every depot, station or office of such carrier where passengers or freight, respectively, are received for transportation, in such form that they shall be accessible to the public and can be conveniently inspected. * * *

"And when any such common carrier shall have established and published its rates, fares and charges, in compliance with the provisions of this section, it shall be unlawful for such common carrier to charge, demand, collect or receive from any person or persons, a greater or less compensation for the transportation of passengers or property, or for any services in connection therewith, than is specified in such published schedules of rates, fares and charges as may at the time be in force.

"Every common carrier subject to the provisions of this act shall file with the Commission hereinafter provided for, copies of its schedules of rates, fares, and charges which have been established and published in compliance with the requirements of this section, and shall promptly notify said Commission of all changes made in the same. Every such common carrier shall also file with said Commission copies of all contracts, agreements, or arrangements with other common carriers, in relation to any traffic affected by the provisions of this act, to which it may be a party. And in cases where passengers and freight pass over continuous lines or routes operated by more than one common carrier, and the several common carriers operating such lines or routes establish joint tariffs of rates, or fares, or charges for such continuous lines or routes, copies of such joint tariffs shall also, in like manner, be filed with said Commission. Such joint rates, fares and charges on such continuous lines, so filed as aforesaid, shall be made public by such common carriers when directed by said Commission, in so far as may, in the judgment of the Commission, be deemed practicable; and said Commission shall from time to time prescribe the measure of publicity which shall be given to such rates, fares, and charges, or to such part of them as it may deem it practicable for such common carriers to publish, and the places at which they shall be published."

Act March 2, 1889, c. 382, § 1, 25 Stat. 855 (3 U. S. Comp. St. 1901, p. 3156; 3 Fed. St. Ann. 827-829).

Each count of the indictment is based upon a car load of petroleum and products of petroleum, irrespective of the number of pounds, carried by such car (in some cases thirty thousand pounds, in other cases eighty thousand pounds) and irrespective, also, of whether the car constituted the whole or a part only of an actual shipment—the plaintiff in error being convicted of as many offenses as there were car loads, although each car load was in some instances but one only, in a number of car loads that made up the shipment.

From 1 to 885 inclusive, the counts charge, that during the period covered by the shipment, the said Chicago & Alton Railway Company, as required by law, kept open for public inspection at Whiting and Chappell, its printed tariffs and schedules then in force upon its route; and, as required by law, filed copies of such tariffs and schedules with the Interstate Commerce Commission; which tariffs and schedules, so published and filed, showed the rate for the transportation of petro-

leum and products of petroleum, in car load lots, from Whiting, Indiana, to East St. Louis, Illinois, to be eighteen cents per one hundred pounds, all of which was well known to the plaintiff in error; but that said Railroad Company, at the request, and on account of said plaintiff in error, did unlawfully engage in the transportation in interstate commerce from Whiting to St. Louis, of the property named, at a total rate and charge to said plaintiff in error, for such transportation, of six cents for each one hundred pounds, under a common arrangement between the said Railway Company and the Chicago Terminal Transfer Railroad Company, for continuous carriage and shipment of such property from Whiting to East St. Louis; wherefore the plaintiff in error unlawfully did knowingly accept and receive from said Railway Company, the concession named. The remaining counts of the indictment from 886 to 1903 inclusive, are in the same form as the previous counts (except as to the dates, weight, description of property, number, of car and the like) with this exception, that the transportation was charged to be from Chappell, in Illinois, to St. Louis in the State of Missouri—the published tariff being charged to be nineteen and one-half cents per one hundred pounds, and the total rate and charge to plaintiff in error being seven and one-half cents for each one hundred pounds.

There are one hundred and sixty-nine assignments of error, taking up seventy-six pages of the printed record. In view of the conclusion, however, to which we have come, it is unnecessary to review many of these assignments—the ones reviewed covering all the propositions of law that we deem essential to the guidance of the District Court in the event of a second trial. Comprehensively stated, the assignments of error that we shall review, relate:

First: To the view adopted by the trial court, carried out in its rulings on the admission and exclusion of evidence, and embodied in its charge to the jury, that a shipper can be convicted of accepting a concession from the lawfully published rate, even though it is shown, as bearing on the matter of intent, that the shipper, at the time of accepting such concession, did not know what the lawfully published rate actually was;

Secondly: To the view adopted by the trial court that the number of offenses is the number of car loads of property transported, irrespective of whether each car load constituted the whole or a part only, of a single transaction resulting in a shipment; and

Thirdly: Whether, in the imposition of the fine named, the trial court abused the discretion vested in the court.

We shall take up these subjects in the order stated, the first being whether a shipper can, without error, be convicted of accepting a concession from the lawful published rate, even though it is shown, as bearing on the matter of intent, that the shipper, at the time of accepting such concession, did not know what the lawful published rate actually was—a view of the law that is embodied in the charge, and carried out in the ruling excluding certain proffered testimony including, as a result of the charge on that point, the testimony of one Edward Bogardus, who, being in absolute charge of the traffic affairs of plaintiff in error during the period covered by the transac-

tions, was offered to testify on that point, that during the period involved, he did not know anything about an eighteen cent rate over the Alton Railroad; that his attention had never been called to any such rate by any person, or by the examination of any document; and that it was his understanding and belief, based on what he was told by one Hollands, Tariff Clerk for the Alton Railroad, that the rate over the Alton road was six cents; and that such rate had been filed with the Interstate Commerce Commission.

Hollands, who was called by the government, had previously testified that he had no recollection of telling Bogardus that the six cent rate (a commodity rate) had been filed with the Interstate Commerce Commission. But answering on his voir dire, the jury being excused, Hollands further stated that he regarded six cents per one hundred pounds as the oil rate between Whiting and East St. Louis; that he regarded a certain application sheet, which covered Whiting at Chicago rates, and the sheet for Chicago, taken together, as showing a six cent commodity rate; that whenever he spoke of a rate on this commodity between Whiting and East St. Louis, he had in mind those papers; and that if he had been asked by Bogardus or anybody else, whether there was a rate between Whiting and East St. Louis, he would have answered that there was, and that it was filed, and that such rate was six cents; which evidence thus proffered was excluded by the court, for the sole reason that, as a matter of fact, as the court (not the jury) found the fact to be, the application sheet containing this six cent commodity rate had not been filed with the Interstate Commerce Commission. Had the court found, as a fact, that that sheet had been so filed, or, submitting that question to the jury, had the jury found that that sheet had been so filed, the six cent rate given to Bogardus admittedly would have been the lawful published rate.

In addition to this, Bogardus was offered as a witness to prove that a tariff prescribing a rate of six and a quarter cents per one hundred pounds from Whiting to East St. Louis was issued by the Chicago & Eastern Illinois Railroad Company, a competing line, October 9th, 1895, and filed with the Interstate Commerce Commission October 11th, 1895; that such tariff sheet was among the tariff files in possession of the plaintiff in error; that plaintiff in error, during the period named, shipped thereunder a large number of cars of petroleum and its products, from Whiting to East St. Louis, over the Eastern Illinois, at said rate; and that such rate of six and a quarter cents was equivalent, to the shipper, of the rate of six cents over the Alton, owing to a quarter of a cent terminal charges, all of which evidence was excluded, as also the offer of the tariff sheet itself, produced from the files of the Interstate Commerce Commission, and an amendment thereto filed in April, 1903.

The relation between the action of the trial court in thus excluding this evidence, and the charge of the court on the subject of knowledge, is apparent. The view embodied in the charge is as follows:

"The indictment alleges that the defendant accepted the concession knowingly. To sustain this averment the proof need not establish that the defendant had actual knowledge of the lawful rate. It was the duty of the defend-

ant to diligently endeavor in good faith to get from the Chicago & Alton Company the lawful rate by applying to the Alton Company at one of its freight or traffic offices or depots. In making this endeavor the defendant is presumed to have known that the Railway Company would be guilty of a misdemeanor if it gave the defendant a rate on interstate traffic which was not set down on paper, and a copy of the schedule filed with the Interstate Commerce Commission. The defendant must also be presumed to have known that the defendant would be guilty of a misdemeanor if it accepted a rate for the transportation of property in interstate commerce which was lower than a rate thus published at a railway station or traffic office and filed with the Interstate Commerce Commission.

"The defendant must be held to have known that which this diligent endeavor would have enabled it to find out. Therefore, if you believe from the evidence beyond a reasonable doubt that such endeavor on the part of the defendant would have enabled it to ascertain the lawful rate as I have defined lawful rate to you in these instructions, and that the defendant did not make the endeavor in good faith, such failure on defendant's part will not excuse defendant, and you will find it guilty on those counts of the indictment, if any, which under these instructions, you find sustained by the evidence."

Of course if this view of the law is sound, the action of the court, in its rulings on the evidence offered, as well as its charge, is without error; for if a shipper can be held guilty of accepting a concession from the lawful published rate, even though the shipper had no knowledge of what the lawful published rate was—if the plaintiff in error, in the transactions before us, was bound, at its peril, first to successfully disentangle the Alton's confused tariff sheets, and then correctly to interpret them—the evidence excluded could have had little determinative weight in any judgment of the jury upon the guilt or innocence of the shipper. But if, on the contrary, it is necessary to a conviction of a shipper of accepting a concession from the lawful published rate, that it should appear as bearing on intent, that the shipper knew what the lawful published rate was, the evidence offered and excluded clearly relates to the fact of such knowledge, and was erroneously excluded, because the plaintiff in error was thereby deprived of its right to have the judgment, not of the court alone, but of the jury as to whether the plaintiff in error had such knowledge as charged him with an intent to violate the law. Indeed the whole question is the fundamental one of whether a shipper is guilty, under the Interstate Commerce Act, of having accepted a rate less than the lawful published rate, even though he does not know, at the time, that the rate accepted was in fact less than the published rate, thereby having no intent to violate the law; or, as the Supreme Court stated the question in *Armour Packing Company v. United States* (decided March 16, 1908) 209 U. S. 56, 28 Sup. Ct. 428, 52 L. Ed. 681, whether "shippers who pay a rate under the honest belief that it is the lawful published rate when in fact it is not, are liable, under the statute, because of a duty resting on them to inform themselves as to the existence of the elements essential to establish a rate as required by law."

The trial court was doubtless influenced by judicial holdings in cases under statutes against smuggling, the sale of liquors to minors, and other cases arising out of fiscal and police regulations, for the mere violation of which, irrespective of the motive or intent, certain penalties are enforced (*Greenleaf on Evidence*, § 21; 1 *Wharton Crim.*

Law (10th Ed.) § 23a; *United States v. Bayard* (C. C.) 16 Fed. 376 and other cases cited); and thus influenced, proceeded on the view that if the shipper can, by diligent endeavor, decipher out of the tariff sheets, no matter how entangled or confused they may be, a rate that a court, upon subsequent investigation, no matter how close the question thus raised may be, determines to be the lawful published tariff rate, under all the circumstances named, the shipper may not plead that under information from the carrier or any other investigation short of diligent research on his own account, he mistook another rate to be the lawful published rate—may not plead that he had no intent to violate the law.

In this interpretation of the interstate commerce law, so far as it relates to shippers, we cannot concur. The cases cited by the government, such as those requiring liquor sellers, at their peril, to know whether the person to whom a drink is sold, is a minor, or within the prohibitions of the act or not, are not controlling, nor very persuasive. The Interstate Commerce Act was intended to promote, not to restrain trade and commerce—to secure fair dealing in commerce through uniformity, not to put obstructions in the way of commerce. *Texas & Pacific R. R. v. Interstate Commerce Com.*, 162 U. S. 197, 16 Sup. Ct. 666, 40 L. Ed. 940. Surely the farmer who brings his produce to town to be shipped to the city markets, or the small merchant shipping to the country, or the householder who ships his furniture, when changing his residence, were not meant by the interstate commerce law to be guilty of having accepted a concession, merely because they took the word of the carrier or his agent, as to what the rate was, accepting such rate stated, in the honest belief that it was in fact the regularly established rate. In this respect the shipper and the carrier stand on different ground. The carrier is required by a separate provision of the law to establish and publish rates (section 6) and is forbidden to charge or collect from the shipper a rate greater or less than such established and published rate; and as to the carrier, the doctrine laid down by Wharton and by Judge Cooley in *Bonker v. People*, 37 Mich. 4, that ignorance of the fact is no defense is perhaps applicable; for the carrier having established and filed the rate, can very justly be denied the right to plead that he overlooked or forgot the rate that he has thus knowingly established and filed. But is the ordinary shipper, under any reasonable view of the situation to which the law relates, thus bound—bound at his peril, under this law intended to promote commerce, to cipher out, before he can safely put anything that he has into commerce, all the confusing papers and figures that generally make up the tariff sheet? Plainly not, it seems to us. As to him, the language of Bishop (1 Bishop, *New Criminal Law*, § 286) seems sound, that:

“It is never right to punish a man for walking circumspectly in the path which appears to be laid down by the law, even though some fact which he is unable to discover renders the appearance false. And for the Government, whether by legislation or by judicial decree, to inflict injustice on a subject, is to injure itself more than its victim. And the court should, in all circumstances, so interpret both the common law and the statutes as to avoid this wrong.”

And though it is true that large shippers like the plaintiff in error do not usually take the word of the carrier as to what the rate is, but examine for themselves the tariff sheets, and have all the knowledge that is necessary to an intelligent examination, from which it might easily follow, as a matter bearing wholly on the weight of the evidence, that professions of ignorance upon the part of such shipper would stand on a different plane of credibility from a plea of ignorance put forward by the ordinary shipper, it does not, on that account, follow that the ultimate question of intent, to be submitted to the jury, is not the same whether the shipper be a large one, or a small one; for the law is the same for all shippers, and the duty devolving on the government is the same, viz.: that before conviction, there must be proof of all the facts upon which the shipper's offense is predicated.

This view of what is essential to constitute the offense, makes it plain that the trial court was in error, as a matter of law, in the application, to the case of a shipper, of the principles that the trial court applied to this case. And this error is made all the plainer, lifting it from what might otherwise be considered a mere technical error, to the level of a real substantial error, when the exact nature of the so-called tariffs published and filed, relied upon by the government as the lawful rate, are scrutinized; and when the rate that the trial court deciphered out of these papers, is compared with admitted rates on other roads for the same products, and with the admitted rates on the same road for like products. The tariff sheet relied upon as the lawful published rate filed with the Interstate Commerce Commission, is tariff sheet No. 24 of the Chicago & St. Louis Traffic Association; and the first thing to be noted is that this tariff sheet No. 24 makes no reference, by name, to petroleum or the products of petroleum. On the face of that tariff sheet, no eighteen cent rate for petroleum or the products of petroleum appears. The eighteen cent rate was only arrived at by a process of circumlocution; that is to say, on the face of these tariff sheets there was found the printed line "Governed by Illinois classification except as noted herein"; then by turning to a classification adopted by the Railroad & Warehouse Commission of Illinois, September 7th, 1899, it was found that petroleum and its products were set down in the "fifth" class; and then by turning back to tariff sheet No. 24, it was found that the rate set down for the "fifth class" was eighteen cents per one hundred pounds. And so, out of this process of reference and cross reference, the lawful published rate was evolved by the trial court to be eighteen cents, not because it so appeared on the face of the tariff sheets, but because, by reference to other sheets—sheets fixing, not rates, but classification, and that not by the Interstate Commerce Commission or the carrier, but by the Illinois Railway Commission—it could be so figured out.

Now many nice judicial questions are raised, in this case, upon the accuracy and validity of the result thus arrived at. Tariff schedule No. 24, for instance, with the words thereon printed, "Governed by Illinois Classification," took effect May 15th, 1899. The Illinois classification, that the government relies upon as adoption by reference, was not adopted until nearly four months afterwards, to-wit, September 7th, 1899. No proof is in the record either of the terms or the

existence of any Illinois classification as of May 15th, 1899, the time the tariff sheet was filed. Do the words, "Governed by Illinois Classification" refer to a classification presently in existence—the classification in existence when the tariff was filed? If so, the proof fails, for no such classification is shown. Are the words to be interpreted as if they read: Governed by Illinois Classification "as from time to time that classification may be changed"? If so, it is only because words not expressed are to be judicially imported into the face of this tariff sheet—the clause to be so enlarged by judicial interpretation, that it would be thereafter within the power of state commissions, at any time, through changes of state classifications, to alter from time to time, and without consent of the interstate carriers, interstate rates for interstate commerce, unless such interstate carrier instantly reformed its tariff sheets to the changed classifications of the several state commissions. Indeed, taking this along with some of the other questions that have been brought to our attention in connection with these schedules, we are not prepared to say that tariff sheet No. 24 really fixes the rate on petroleum and its products at eighteen cents. The most we can say is, that the question is one upon which judges, after full discussion, might very reasonably disagree. And when to this we add that the representative of the plaintiff in error, in charge of its traffic affairs, knew that a six and a quarter cent rate—the equivalent of a six cent rate over the Alton—was the lawful published rate of the competing Chicago & Eastern Illinois Railroad, duly filed with the Interstate Commerce Commission; that in this tariff schedule No. 24 there were no oils, and nothing similar to oils even though small in quantity as freight compared with petroleum and its products, scheduled at more than ten cents; that he had been told by the Alton representative that six cents was the lawful Alton "commodity" rate; that he knew that in 1903 there were in force on the Alton road, three hundred and eighty-six commodity tariffs of the same character as the six cent tariff which he was told was the commodity tariff on petroleum and its products, and in 1904 and 1905 even a larger number of such commodity tariffs; and when we bear in mind that all that prevented the trial court from holding, as a matter of law, that a six cent rate upon petroleum and its products was a lawful commodity rate was that, technically, the filing with the commission of the application sheets upon which that proposed commodity rate appeared was not, in the trial court's opinion, the filing of a tariff within the requirements of the law; and when we put against this positive information, and these strong confirmatory circumstances, a confused mass of tariff sheets that on their face show no rate on petroleum and its products whatever, leaving it to the judicial mind to cipher out the eighteen cent rate by reference to other papers that may or may not have been properly interpreted, the error of the trial court in taking away from the plaintiff in error its right to submit to the jury the whole question of whether it had knowledge of the tariff sheet from which it is said to have accepted a concession, and therefore an intent to violate the law—whether the rate paid was not paid in the honest belief that it was the lawful rate—is an error that rises into one of solid substance.

This brings us to the second question: Whether, as a matter of law the number of offenses is the number of car loads of the property transported, irrespective of whether each car load constituted the whole, or a part only, of an actual single transaction resulting in a shipment.

The shipments upon which the indictment was based were within the period from September 1, 1903, to March 1, 1905; were carried in fourteen hundred and sixty-two car loads; and were settled for, and the charges thereon paid, upon thirty-six distinct days within that period. The proof shows, also, that in the regular course of business, whenever an order came to plaintiff in error from a buyer in the St. Louis district (the order being in gallons or barrels, not cars) the order was translated by the clerks into car loads, according to the capacity of the cars, running all the way from thirty thousand to eighty thousand pounds; that the oil was then loaded upon the cars—cars for that purpose nearly always standing in the yards; and that the cars were then turned over to the carrier, some single orders filling six or eight cars. Notwithstanding this, in the indictments, and upon sentence, each single car load was dealt with as a separate offense.

At the trial, the plaintiff in error moved, severally, that the government be required to proceed upon one count only and to elect such count; that the government be required to proceed upon one count averred to have taken place during each of the years 1903, 1904 and 1905, respectively, and to elect such count; and that the government be required to proceed upon thirty-six counts only, or upon as many counts as there were settlements and payments by the shipper to the carrier, and to elect such counts; all of which motions were overruled.

The chief argument, if we rightly comprehend the argument and can state it compactly, in favor of the proposition that under these circumstances each car transported constituted a separate offense is, that each "act of transportation," whereby property in interstate or foreign commerce is transported at the prohibited rate, constitutes a distinct offense, and that each car was a separate act of transportation, as was evidenced by the issuing of a way bill to the plaintiff in error for every car.

The offense denounced in the statute, and charged in the indictment, is the accepting by plaintiff in error of a concession in respect to the transportation of property in interstate commerce, whereby such property was transported at a less rate than that named in the tariffs published and filed. The gist of the offense is the acceptance of the concession, irrespective of whether the property involved was car loads, train loads, or pounds. Has a shipper fully and finally accepted a concession when he has done nothing more than to agree with the carrier that less than the published and filed rates shall be paid for transportation of his property? Is it not necessary that the transaction be closed by actual payment of the lower rate? Take the rebate, the commonest form of the evil—the concession being only a variety. In the rebate, the shipper pays in the first instance the full rate to the carrier and afterwards receives back a part. Manifestly the offense of accepting a rebate has not been committed until the shipper has

taken back a part of the freight money, whereby his property has been transported at less than the lawful rate. Proof that he agreed to accept a return of a part of the full rate—stopping there—would not support an indictment for accepting a rebate. Such an agreement is not binding; and at any time before its complete fulfillment the shipper may repent and insist upon the carrier's keeping the whole amount. The concession differs from the rebate only in this, that in the concession the shipper, instead of paying the full rate and receiving back part, merely settles for the difference. The result is the same—the property is transported for the same net amount less than the lawful rate. And there is no basis in the statute for holding that in the case of accepting a concession the transaction is consummated, and the door of repentance is closed, at any earlier moment than in the case of accepting a rebate. So proof that a shipper has agreed to accept a concession—stopping there—whether the proof be embodied in way bills, or book entries, or formal contracts, will not support an indictment for accepting a concession, until the intended wrong becomes an accomplished fact. Of course the irrevocable may be reached and the transaction consummated in other ways than by money settlements, as by the off-setting of mutual accounts. The point is that the transaction, as a transaction, must be consummated.

The offense of accepting a concession is the "transaction" that the given rebate consummates—not the units of mere measurement of the physical thing transported—but the "transaction" whereby the shipper, for the thing shipped, no matter how great or how little its quantity, received a rate different from the established rate—the wide range between maximum and minimum punishment being doubtless thought to be a sufficient range within which to differentiate the punishment adapted to one transaction, from the punishment adapted to another.

The number of offenses in the present case should have been ascertained in accordance with these principles. The measure adopted by the trial court was wholly arbitrary—had no basis in any intention or fixed rule discoverable in the statute. And no other way of measuring the number of offenses seems to have been given a thought either by the government or the trial court.

This brings us, then, to the last question, Did the court, in the fine imposed, abuse its discretion? The defendant indicted, tried and convicted, was the Standard Oil Company, a corporation of Indiana. The capital stock of this corporation is one million dollars. There is nothing in the record, in the way of evidence, either before conviction, or after conviction and before sentence, that shows that the assets of this corporation were in excess of one million dollars. There is nothing in the record, either before conviction, or after conviction and before sentence, that shows that the defendant, before the court, had ever before been guilty of an offense of this character. It may, therefore, be safely assumed, that but for the relation of the defendant before the court to another corporation not before the court—a relation to be presently stated—the court would have measured out punishment on the basis of the facts just stated.

That under such circumstances the punishment would have been

the maximum punishment, does not seem possible; for, bearing in mind that this is not the punishment of an unlawful business, but the punishment of unlawful practices connected with a lawful business, the maximum sentence, put into execution against the defendant before the court, would wipe out, many times, and for its first offense, all the property that constitutes the defendant's lawful business. Put into execution, this maximum sentence would add to the liabilities of defendant to its creditors, (and, according to a petition of the government on the matter of supersedeas there were current liabilities of from three to five million dollars) an additional liability of twenty-nine million, two hundred and forty thousand dollars; resulting without doubt in a condition of bankruptcy that would deduct from every creditor's share of the assets to be divided a sum running from fifty to nearly one hundred per cent. of the money that such creditors had advanced. Is the defendant, by way of regulative punishments, to be thus punished? Are the creditors to be thus punished? Would a cab driver, convicted of violating the city law against excessive cab fares, be sentenced to pay a fine that would take his horse and cab, and then leave him a bankrupt many times over, unable to pay anything but the least proportion of his debts to his other creditors? Is this case another case, simply because, instead of being an individual, the defendant is a corporation, and instead of being up for sentence under a city ordinance that was intended, not to destroy, but to regulate, the defendant was up for sentence under a national law that was intended, not to destroy, but to promote? Indeed, that the sentence was not imposed on the basis of the facts just stated respecting the defendant before the court, but was imposed wholly because of other facts, wholly outside the record so far as this defendant is concerned, is disclosed by the reasons set out in connection with the sentence.

Briefly stated, the trial court had in mind when the sentence was fixed, not so much the Standard Oil Company of Indiana, as the Standard Oil Company of New Jersey; and intended by the imposition of this sentence, to reach and punish, not so much the Standard Oil Company of Indiana, as the Standard Oil Company of New Jersey. "The nominal defendant is the Standard Oil Company of Indiana, a million dollar corporation. The Standard Oil Company of New Jersey, whose capital stock is one hundred million dollars, is the real defendant," says the trial court in imposing the sentence; and with this in mind "for the guidance of the court in determining the penalty to be fixed" the court says information was requested, as to what corporation held the stock of the Standard Oil Company of Indiana, what the outstanding capital stock of such "holding" company was, and what its (the holding company's) net earnings and dividends were, for the three years covered by the indictment, in order, as the court said, that it might "advisedly exercise the discretion required by the law in fixing the punishment." And, when such information was not furnished, it was the officers of the Standard Oil Company of New Jersey who were subpoenaed before the court, and it was the net earnings and dividends, not of the Standard Oil Company of Indiana, but of the Standard Oil Company of New Jersey, that was obtained, for the three years covered by the indictment—proceedings and a purpose

that have no meaning unless, in the mind of the court, one of the parties to the punishment was to be the Standard Oil Company of New Jersey.

That this was the view and purpose of the trial court is again disclosed in the reason given why the fine was fixed at the amount stated, viz.: "that for the law to take from one of its corporate creatures, as a penalty for the commission of a dividend producing crime, less than one-third of its net revenues accrued during the period of violation, falls far short of the imposition of an excessive fine"—the "dividend producing crime" in the mind of the court obviously being the crime, not of the Standard Oil Company of Indiana (it had not been brought out what were that company's net revenues)—but of the Standard Oil Company of New Jersey, whose net revenues were said by the court, in this connection, to be "approximately forty per cent." upon the "approximately one hundred million dollars" of its capitalization.

And again, in fixing the penalty, the trial court said "in this connection it may be observed that the figures exhibiting the net earnings of the Standard Oil Company of New Jersey during the period covered by this indictment are exceedingly instructive, because of the peculiarly intimate relation between the character of the crime, and the revenues of the offender"—a remark wholly without meaning unless the court had in mind the revenues of the Standard Oil Company of New Jersey, for, as already stated, no revenues of the Standard Oil Company of Indiana were in the record; and a remark also wholly without meaning, unless the court had in mind that the offense for which he was fixing the punishment was not the company's first or "virgin" offense; for all the revenues derived from the transactions involved in the trial were—so far as the record enables us to figure them out—an infinitesimal amount merely of the amount of revenues upon which that statement was based. Indeed, that it was the Standard Oil Company of New Jersey that the trial court was reaching out for, counsel for the government do not dispute, but seek rather to justify by the statement that:

"The effect of these violations of the law was to enhance the earnings of the Standard Oil Company of Indiana, and every dollar of the increased earnings of that company, went into the treasury of the Standard Oil Company of New Jersey. It was the Standard Oil Company of New Jersey, therefore, who was the real beneficiary of the unlawful acts of the plaintiff in error."

Now can a sentence such as the trial court imposed, based upon reasoning such as the trial court gave, be a sound sentence? Can a court without abuse of judicial discretion, wipe out all of the property of the defendant before the court, and all the assets to which its creditors look, in an effort to reach and punish a party that is not before the court—a party that has not been convicted, has not been tried, has not been indicted even? True it is, that if one corporation uses another corporation to violate law, just as if one individual uses another individual to violate law, such offender ought not, though masked, to go unpunished. And there are ways, as old as the law itself, to reach and punish him. But can the individual who is merely "said" to have procured the crime to be committed be deprived of a hear-

ing—be condemned to punishment without being tried, convicted, or indicted even? Can an individual merely “said” to be behind the party convicted, be reached for punishment, not by indictment, trial, and conviction in due process of law, but by supplemental proceedings before the judge, somewhat in the nature of civil proceedings in aid of execution? Can an American judge, without an abuse of judicial discretion, condemn any one, individual or corporation, who has not, in his own person, first been duly indicted, duly tried, and duly convicted?

That, to our mind, is strange doctrine in Anglo-Saxon jurisprudence. No monarch, no parliament, no tribunal of Western Europe, for centuries, has pretended to have the right to punish except after due trial under all the forms of the law. Can that rightfully be done here, on no other basis than the judge’s personal belief that the party marked by him for punishment deserves punishment? If so it is because the man who happens to be the judge is above the law.

Counsel for the government say, in concluding their brief, that the Elkins Act was passed because the peace of society and the welfare of the people demanded it; that railroad inequality means business ruin to all except those powerful enough to make themselves the beneficiaries of the discriminations; means the wiping out of an industry, of a town, of a city, at the command of an officer of a private corporation; that railroad inequality is the basis of monopoly and the wrongful concentration of wealth; that no law of more vital importance was ever passed by congress; and that those guilty of violating it, are guilty of a serious crime against the principles of industrial freedom and equality.

Every sentence of that arraignment is true. That this court recognizes the importance of the enforcement of that act is shown in its affirmance of penalties that under other circumstances would be regarded as very severe. But the Interstate Commerce Act, important as that law is, is not the only law under which we live. We live under a guaranty that reaches back to the beginnings of our law, and is securely planted in every constitution of civilized government, that no one shall be punished until he has been heard; and above this fundamental guaranty there can be set no higher prerogative; for let it once come to pass that under the stress of enforcing commercial equality, any power in the government may override the fundamental human right of being judged only after having been duly tried—a right just as essential to men in the associated relationship of the corporation, as to men in the relationship of copartners, or to men individually—there will remain no commerce worth the name to safeguard. The beginning of commerce is constitutional government, and the foundation of constitutional government is the faith that every guaranty of our institutions, no matter what the provocation, will be sacredly observed.

The judgment of the District Court is reversed and the case remanded with instructions to grant a new trial, and proceed further in accordance with this opinion.

BAKER, Circuit Judge (concurring). The judgment of reversal seems to me inevitable; and I agree that each of the three stated

grounds is well taken. I purpose merely to state some considerations which I have deemed particularly controlling with respect to the first and third questions.

The most important question, because involved in every prosecution for rebating, is the proper construction of the statute. Carriers are forbidden "to offer, grant or give," and shippers "to solicit, accept or receive any rebate, concession or discrimination in respect of the transportation of any property in interstate or foreign commerce * * * whereby any such property shall, by any device whatever, be transported at a less rate than that named in the tariff published and filed." Each count of the indictment alleged that the defendant knowingly accepted and received a concession. The court charged that "it was the duty of the defendant to diligently endeavor in good faith to get from the Chicago & Alton Company the lawful rate by applying to the Alton Company at one of its freight or traffic offices or depots," and that "the defendant must be held to have known that which this diligent endeavor would have enabled it to find out." The court refused to charge that the defendant could not properly be convicted unless it "either actually knew that it was accepting and receiving a concession or willfully and intentionally ignored facts and circumstances known to it which would have led to such knowledge." Thus a line was drawn between the negligent (unintentional) failure to ascertain the rate and the willful (intentional) disregard of knowledge of the rate or of facts which would lead to such knowledge. Did Congress denounce as an indictable offense a shipper's negligence, namely, his unintentional failure to learn the published and filed rate?

The purpose of all canons of interpretation is to discover and effectuate the will of the lawmakers; and the primary rule, to which all others are subsidiary, is to read the text according to the ordinary rules of grammar and composition, and to take the words in their usual meanings. For the carrier, "to offer" or the shipper "to solicit" involves the knowing and consenting mind. No common, no lexical, no technical definition to the contrary can be found. To say "to offer knowingly," "to solicit knowingly," is the veriest tautology. Likewise "to grant" or "to accept" requires the conscious and understanding act of the intellect and will. If one does not know what he is about, his alleged grant is no grant. If one does not know the scope and nature of his act, his alleged acceptance is no acceptance. Does any ambiguity arise because the words "to give" and "to receive" are also used? "To offer" and "to solicit" characterize the inchoate act. The completed act that is condemned is for the carrier "to grant or give" and the shipper "to accept or receive." Ordinary and accepted meanings of "give" and "receive" are synonymous with those of "grant" and "accept." As all those words appear in the same phrase of the same sentence, the principle of *ejusdem generis* forbids their being taken to indicate acts of antagonistic quality. Further, the emphasis herein given to the verbs is doubled when regard is extended to the nouns, "rebate, concession, or discrimination." Each of these nouns in and of itself implies a comparison with, a measurement by, and a departure from, a determined standard. Congress did not say (but, if it had,

an argument might well be made that negligence in not learning published rates was to constitute a crime):

"The shipper whose property shall be transported in interstate or foreign commerce at a less rate than that named in the published and filed tariffs shall be subject to a fine."

But Congress only said:

"The shipper who shall solicit, accept or receive a rebate, concession or discrimination in respect of the transportation of his property in interstate or foreign commerce shall be subject to a fine."

But even if by lexicon and grammar "to receive a concession" could fairly be given the meaning "to come into the possession of a concession without knowledge or consent," an auxiliary canon of construction would prevent that choice of meanings. That canon is that unless no other way is open a penal act will not be sustained and administered on the theory that it was "cunningly and darkly penned," so as to entrap a merely negligent citizen within the meshes of a criminal prosecution. To couple in the same breath and under the same punishment such vitally different acts as the willful violation of the legally established equality between shippers and the unintentional failure to ascertain a published rate would constitute a trap unparallelled, so far as I have learned, in the annals of legislation.

In further pursuit of the inquiry whether Congress intended to penalize a shipper's unintentional failure to ascertain a published rate, it is permissible to examine and see how Congress has treated the subject of negligence in other parts of the same act. In the very same section the carrier's failure to file and publish rates or to observe them strictly until duly changed is made punishable by the same fine as rebating. "Failure" covers both intentional and unintentional non-performance. So, in the interest of precision, it became necessary to define the quality of the action. And here, at the only place where there was a definite call to say whether negligence should be punishable, Congress explicitly said "No."

Another ancillary canon is to examine the history of the times immediately preceding the passage of a statute in order to learn the evil it was designed to remedy.

In the admirable and exhaustive "Report of the Senate Select Committee on Interstate Commerce," January 18, 1886 (Senate Report 46, 1st Session, 49th Congress), the following appears on pages 188-190.

"Differences in rates between different commodities of a similar character are often unavoidable and justifiable, as has been shown, but no excuse can be offered for any discrimination in the charges made by a common carrier as between persons similarly situated for whom a like service is performed under similar circumstances. This is the most flagrant and reprehensible form of arbitrary discrimination. Individual favoritism is the greatest evil chargeable against the management of the transportation system of the United States. The evidence before the committee shows that it has come to be considered by railroad officials as an indispensable feature of the system upon which their business is now carried on, and reveals its existence to an extent that imperatively demands additional legislation to protect the people in their common-law rights and to insure them the equal enjoyment of the advantages of transportation.

"One reference to the testimony must suffice to illustrate the universality of individual favoritism, the reasons which influence the railroads in favoring one shipper to the ruin of another, and the injustice of the system. Mr. C. M. Wicker, of Chicago, a former railroad official of many years' experience, was asked if he knew anything of discriminations upon the part of transportation companies as between individuals or localities, and testified as follows:

"Mr. Wicker: 'Yes; I do. And this discrimination, by reason of rebates, is a part of the present railroad system. I do not believe the present railway system could be conducted without it. Roads coming into the field today and undertaking to do business on a legitimate basis of billing the property at the agreed rates would simply result in getting no business in a short time.'

"Senator Harris: 'Then, regardless of the popularly understood schedule rates, practically it is a matter of underbidding for business by way of rebates?'

"Mr. Wicker: 'Yes, sir; worse than that. It is individual favoritism; the building up of one party to the detriment of the other. I will illustrate. I have been doing it for years myself, and had to do it.'

"Senator Harris: 'Doing it for yourself in your position?'

"Mr. Wicker: 'I am speaking now of when I was a railroad man. Here is quite a grain point in Iowa, where there are five or six elevators. As a railroad man, I would try and hold all those dealers on a "level keel," and give them all the same tariff rate. But suppose there was a road five or six or eight miles across the country, and those dealers should begin to drop in on me every day or two, and tell me that that road across the country was reaching within a mile or two of our station and drawing to itself all the grain. You might say that it would be the just and right thing to do to give all the five or six dealers at this station a special rate to meet that competition through the country. But, as a railroad man, I can accomplish the purpose better by picking out one good, smart, live man, and, giving him a concession of three or four cents a hundred, let him go there and scoop the business. I would get the tonnage, and that is what I want. But if I give it to the five, it is known in a very short time. * * * When you take in these people at the station on a private rebate, you might as well make it public and lose what you intend to accomplish. You can take hold of one man, and build him up at the expense of others, and the railroad will get the tonnage.'

"Senator Harris: 'The effect is to build that one man up and destroy the others?'

"Mr. Wicker: 'Yes, sir; but it accomplishes the purposes of the road better than to build up the six.'

"Senator Harris: 'And the road, in seeking its own self-preservation, has resorted to that method of concentrating the business into the hands of one or a few to the destruction of the many?'

"Mr. Wicker: 'Yes, sir; and that is a part and parcel of the system.'

"Senator Harris: 'Is that system continued up to this time?'

"Mr. Wicker: 'Yes, sir.'

* * * * *

"The practice prevails so generally that it has come to be understood among business men that the published tariffs are made for the smaller shippers and those unsophisticated enough to pay the established rates; that those who can control the largest amounts of business will be allowed the lowest rates; that those who, even without this advantage, can get on 'the inside,' through the friendship of the officials or by any other means, can at least secure valuable concessions; and that the most advantageous rates are to be obtained only through personal influence or favoritism or by persistent 'bulldozing.'

"It is in evidence that this state of affairs is far from satisfactory, even to those specially favored, who can never be certain that their competitors do not, or at any time may not, receive even better terms than themselves. Not a few large shippers, who admitted that they were receiving favorable concessions, testified that they would gladly surrender the special advantages they enjoyed if only the rates could be made public and alike to all.

"This suggests the remedy that should be applied, and the question of securing publicity of rates will be considered hereafter. The secrecy which at-

tends these transactions is the only evidence that is needed of their injustice. The uncertainty as to the rates actually charged which the system of personal favoritism occasions is demoralizing to all legitimate business, and is calculated to encourage only that which is purely speculative.

"The methods by means of which personal favoritism may be indulged in are limited in variety only by the ingenuity and inventive capacity of the railroad officials. Its most common manifestation is in the form of special contracts, special rates, rebates, underbilling, and other secret devices for evading the schedule rates; but it is possible to accomplish the same purpose in so many different ways, when desired, that the absolute prevention of the practice will be attended with no little difficulty."

A book that was cited in the debates was Hudson's "The Railways and the Republic," published in 1886. This work (particularly the chapters on "Ten Years of Discrimination," "The History of a Commercial Crime," "The Law and the Railways," and "The Discussion of Remedies") indicates quite as clearly as does the Senate report that the evil to be remedied was "personal favoritism," brought about by secret understandings and arrangements between railroads and favored shippers, and that the remedy for the evil was to let the light of publicity into the matter of rates, to prohibit all sorts of secret understandings and arrangements under pain of criminal punishment, and to provide a governmental agency to represent the aggrieved shipping public as against the oppressive railroads and their commercial favorites.

After several years of operation it was found that the Cullom act needed amending, not because of any failure to diagnose the evil accurately and fully, nor because of any misapprehension of the general course of treatment needed, but because it was considered desirable to test a prescription of the punitive remedies. All this is proven, I find, by the very clear report of the House Committee on Interstate and Foreign Commerce concerning the pending Elkins bill, February 12, 1903 (House Report 3765, 2d Session, 57th Congress). Under the Cullom act (Act Feb. 4, 1887, c. 104, 24 Stat. 379 [U. S. Comp. St. 1901, p. 3154]) "personal favoritism" was declared unlawful; and it was thought that the practice could be stopped by prescribing fine and imprisonment for any officer or agent of a carrier who entered into a secret arrangement with a shipper. But it was found virtually "impossible to obtain proof of the granting of a rebate by the officer of a railroad to some favored shipper unless the officer himself gives the evidence, in which case he is free from prosecution." So it was proposed to extend the penalty to the corporation carrier itself. Again, the Cullom act made the treatment of other shippers the test of discrimination. It was determined to make the published rates the standard of measurement, and to extend the punishment as well to shippers who solicited or accepted any departure from the published rates. This House report quotes the testimony of members of the Interstate Commerce Commission as exhibiting fully and accurately the then existing conditions that were to be met by the Elkins bill. I set forth a few expressions as illustrative:

"* * * Rebating and rate cutting and all those different devices by which one shipper in a given locality gets better rates than his business rivals.
* * * A railroad officer makes a secret compact with a shipper which gives him a lower rate than the public are required to pay. * * * I want

two things: I want the corporation carrier made liable, and I want the shipper made liable when he accepts a preference or secret rate whether there is discrimination or not. * * * I want to repeat that there are two changes in the law relating to the enforcement of criminal remedies which are important, against which I venture to say no one will come here and interpose opposition. They are that the corporation carrier shall be made liable, and not simply its agent and representative, and that the shipper shall be made liable who knowingly accepts a lower rate than that provided by the published tariff without being obliged to show that he thereby secured a discrimination in favor of himself and against his business rivals."

To my mind this history furnishes clear and affirmative proof that the evil to be remedied in 1887 and in 1903 as well was nothing less than conscious and intended departures from the published rates. The same conclusion is reached by considering certain historical data negatively. While the views and reasons of an individual Senator or Representative expressed in debate cannot be taken as the views and reasons of Congress, yet what fails to appear in the debates may be considered as an historical fact tending negatively to prove what the scope of the evil was that needed remedying. An extended search through the Congressional Record covering the period in 1884 and 1885 when the Reagan bill was pending, in 1886 and 1887 when the bills that resulted in the Cullom act were under consideration, and in 1903 when the Elkins bill was up, has failed to produce a word or hint that a single Senator or Representative during all those years was aware that one of the moving causes of the quarter century's agitation preceding the Elkins act was the negligence of shippers in their unintentional failure to learn that the rates tendered them by carriers were not the true rates.

With respect to the amount of the fine I agree that errors of law were committed. I do not mean that the mere size of the fine involved error. The questions, according to my view, would be the same had there been but one count in the indictment and an assessment thereon of \$20,000. Nor do I mean that the discretion of this court may be substituted for the discretion of the trial court. The case is here upon writ of error, and it is incumbent upon plaintiff in error to prove affirmatively by the record that errors of law entered into the judgment.

The bill of exceptions (the part under consideration is published in 155 Fed. 316-320) shows that the maximum of \$20,000 was reached by acting upon certain matters as aggravations of the offense.

One of these was the finding that the defendant company against which judgment was about to be pronounced was merely a tool of the real offender. Such a circumstance may lawfully be considered in mitigation. To use it in aggravation violates, in my opinion, that principle of the law which forbids the punishment of one for another's crime. The real offender should be proceeded against directly.

Another error of law occurred in denying the defendant company the benefit of the legal presumption that it had not, previously to the times laid in the indictment, violated the interstate commerce law. The record discloses that the court offered to hear in mitigation of punishment "any evidence that might be submitted by the defendant as tending to show that neither it nor the Standard Oil Company of New

Jersey had ever violated the interstate commerce law before"; that the defendant declined to "attempt to show that it has been innocent of any wrongdoing in connection with matters outside of this record, when there is nothing before this court charging it with such wrongdoing," and insisted that the court "must certainly presume the complete innocence of this defendant of any prior violations of the interstate commerce law, and fix its penalty, if any, solely upon the record in this case"; and that the court concluded that:

"Of course, on the trial of a defendant for a specific offense, this presumption is indulged in favor of that defendant as to that offense; but where, as in this case, the crime charged was the acceptance of a preferential railroad rate, in violation of a law that had been on the books for nearly 20 years; where during a period of 18 months, 1,900 car loads of property were shipped at an unlawful rate, which amounted to but one-third of the rate available to the general shipping public; where the convicted defendant's transportation affairs were in the charge of an expert traffic official of at least ordinary intelligence and many years' railroad traffic experience, and who was a frequent visitor at the general freight office of the railway company; where the unlawful rate was shown only by a paper appearing on its face to be a special billing order, and which directed that settlement for services rendered at the rate which it authorized should be made through the railway company's auditor's office instead of at the railway station or freight office, as is done by the general shipping public; and where the defendant when brought to trial persistently maintains that the Constitution of the United States guarantees to it the right to make a private contract for a railroad rate—this court is obliged to confess that he is unable to indulge the presumption that in this case the defendant was convicted of its virgin offense."

Thus, it seems to me, the court virtually found the defendant guilty of prior offenses on the assumption that the state of affairs shown to have existed during the 18 months covered by the indictment extended backwardly from the earliest date named in the indictment. As to the lawfulness of considering prior offenses in aggravation and as to the methods of proving prior offenses, the trial court cited 1 Bishop's New Crim. Law, §§ 948, 950. If Bishop's latitude as to *ex parte* affidavits and hearsay evidence were the established law, error in this case would nevertheless remain, for not even such method nor such evidence was back of the denial of the presumption of innocence.

On Rehearing.

PER CURIAM. The petition for rehearing questions the correctness of the text of that portion of the opinion that relates to the trial judge's statement, in passing sentence, that he was "unable to indulge the presumption that in this case the defendant was convicted of its virgin offense"—the point of the petition being, that in the use of the word "defendant" in connection with "virgin offense," the trial court referred to the Standard Oil Company of Indiana, and not to the Standard Oil Company of New Jersey. The trial court, in passing sentence, expressly stated that the Standard Oil Company of Indiana was but the nominal defendant, the Standard Oil Company of New Jersey being the real defendant; and every word, almost, of the trial court, in arriving at its conclusion respecting the sentence, related to the Standard Oil Company of New Jersey, and not to the Standard Oil Company of Indiana, including the statement that the rev-

enes of the "offender," and the character of the crime, showed that they had a peculiar relation to each other—the revenues referred to obviously being the revenues of the Standard Oil Company of New Jersey—40 per cent. on \$100,000,000—no revenues of the Standard Oil Company of Indiana being in the record at all. And counsel for the government plant their justification of the fine upon the showing of the revenues, not of the Standard Oil Company of Indiana, but of the Standard Oil Company of New Jersey. But as a suggestion that that line in the text of the opinion be changed, the suggestion will be accepted, and the opinion so amplified that while the language used to express the point is changed, the substance of the point involved will be more clearly brought out.

The petition for rehearing also questions the correctness of the text of that portion of the opinion in which, dealing with the question whether a shipper is guilty of accepting a concession, even though it is shown that the shipper, at the time of accepting such concession, did not know what the lawfully published rate actually was, the view taken by the trial court is said to be "a view of the law that is embodied in the charge, and carried out in the rulings 'excluding' certain proffered testimony, including that of one Edward Bogardus"—the point of the complaint being that the testimony of Bogardus, as to whether he knew or did not know of an 18 cent rate over the Alton road, was not "excluded."

Now as a matter of what physically went into the record, Bogardus' testimony was admitted, and went to the jury on the issue adopted by the court whether he had made "diligent endeavor" to ascertain the rate—an issue wholly different from the one upon which it was offered, viz., whether or not defendant had knowledge of what the lawfully established rate was. On the latter issue, the testimony of Bogardus was as effectually excluded by the charge to the jury as if it had physically been expunged from the record.

Courts have the right to expect that counsel accustomed to practice in the courts of review, not only know the meaning of legal terms constantly in use in discussions and opinions of these courts, but will not misuse such terms to spread misinformation respecting a judgment that, in the nature of the case, is bound to attract wide public attention—a remark the germaneness of which the bar of the country will perceive when we say that all that has to be done to obviate the objection made, is to insert a clause so that the portion of the opinion objected to will read "a view of the law that is embodied in the charge, and carried out in the rulings excluding, *as a result of the charge on that point*, the proffered testimony of one Edward Bogardus"—the italicized portion being the only words inserted.

Petition is overruled.

WAILES v. DAVIES et al.

(Circuit Court of Appeals, Ninth Circuit. October 5, 1908.)

No. 1,572.

1. MINES AND MINERALS (§ 23*)—MINING CLAIMS OWNED BY CORPORATION—ASSESSMENT WORK BY STOCKHOLDER.

A stockholder in a mining company has such a beneficial interest in the corporate property that any mining work done by him on unpatented claims of the company must be counted as representative work, and, if sufficient in amount and done at the proper time, will prevent a forfeiture of the claims.

[Ed. Note.—For other cases, see Mines and Minerals, Dec. Dig. § 23.*]

2. FRAUDULENT CONVEYANCES (§ 32*)—SUFFERING LOSS OF PROPERTY—FRAUDULENT RELOCATION OF MINING CLAIMS.

On December 29th defendant obtained a judgment against a mining company, and on the next day an execution was issued and levied on unpatented mining claims of the company, under which they were sold and purchased by defendant. On January 1st following the levy complainant, at the instance of the principal stockholder of the company and with the connivance and assistance of others, relocated such claims, claiming that they had been forfeited by the failure of the company to do the required assessment work for the preceding year. In fact, a sufficient amount of work had been done on some of the claims by the stockholder procuring the relocation, and his purpose was to defeat the collection of defendant's judgment, of which purpose complainant had actual or constructive knowledge. *Held*, that the attempted relocation was in effect a fraudulent conveyance, void as against creditors under Comp. Laws Nev. § 2708, as well as at common law, and that a court of equity would not assist in the consummation of the fraud by quieting the title of complainant as against defendant.

[Ed. Note.—For other cases, see Fraudulent Conveyances, Cent. Dig. § 49; Dec. Dig. § 32.*]

Appeal from the Circuit Court of the United States for the District of Nevada.

Action in equity to quiet title to a group of mining claims situated in Antelope mining district, Eureka county, state of Nevada, and for an injunction against the defendants.

For opinion below, see 158 Fed. 667.

Henry K. Mitchell and Jesse J. Ricks, for appellant.
Alfred Chartz, for appellees.

Before GILBERT, ROSS, and MORROW, Circuit Judges.

MORROW, Circuit Judge. This is an appeal from a decree of the United States Circuit Court for the District of Nevada, dismissing a bill of complaint and dissolving a temporary injunction in a suit brought by appellant to quiet title to certain mining claims, eleven in number, alleged to have been located by him on January 1, 1905, within the Antelope mining district, Eureka county, Nev., on mineral land of the United States, vacant, unoccupied, and open to occupation, location, and purchase under the laws of Congress regulating and governing the sale and purchase of mineral lands. Copies of the notices of each of the several locations are set out in paragraphs 3 to 13 inclusive. These notices set forth that they are in compliance with the Revised

*For other cases see same topic & § NUMBER in Dec. & Am. Digs. 1907 to date, & Rep'r Indexes

Statutes of the United States, describe each claim by courses, distances, and monuments, and contain declarations that until January 1, 1905, the claims belonged to the Whalen Consolidated Copper Mining Company, and that they were taken up by the locator on January 1, 1905, as abandoned claims.

The bill alleges the sinking of discovery shafts, the placing of posts and monuments by complainant, and the recording of location certificates as required by the laws of Nevada, the failure of the Whalen Consolidated Copper Mining Company to do or cause to be done the work required by law during the year 1904, and the consequent forfeiture of the claims. The bill further alleges the recovery of a judgment by defendant Davies in the state court on December 29, 1904, and the levy thereunder on the following day by defendant Sweeney, as sheriff of Eureka county, of an execution on all the right, title, and interest of said Whalen Consolidated Copper Mining Company in and to each and every piece and parcel of land in said bill described, followed by sale at public auction of each and every of said parcels of land to defendant Davies as the highest and best bidder, and the issuing and recording of a sheriff's certificate of such sale, the failure on the part of Davies to do or cause to be done any work on the claims, and the forfeiture of his right, title, and interest therein on the termination of the 31st day of December, 1904. The bill alleges his claim of title, and his securing an injunction through the state court hindering complainant from developing the mines; also the danger of a further cloud of a sheriff's deed at the end of six months. This bill was filed August 7, 1905, and an order was granted August 8th restraining the sheriff from issuing and Davies from receiving a sheriff's deed pending further order of the court.

By leave of court a supplemental bill was filed on December 15, 1905, referring to an injunction issued by the state court on October 19, 1905, upon a complaint filed by the appellant, restraining defendant Davies from entering or encroaching upon the Victoria mine, one of the eleven claims mentioned in appellant's original complaint, and alleging a wrongful encroachment upon two other mines of the disputed group. Upon the supplemental bill of complaint an order was issued on December 23d, restraining Daniel Davies, his servants, agents, or employes, from entering into or upon, or in any manner encroaching upon, any one of the eleven mining claims in controversy, naming them, and referring to the original bill of complaint for their description.

The answer of the defendant admits the mineral character of the land in dispute, also the allegations of the bill of complaint concerning the judgment in favor of defendant Davies, the execution sale, the claim of ownership by Davies, and the intention to execute and pass a sheriff's deed to the property at the end of the six months, but denies all the other material allegations of the complaint, including the forfeiture of the claims by the Whalen Consolidated Copper Mining Company, and especially denying seriatim each and every act of relocation particularly set out in paragraphs 3 to 13, inclusive, of the bill, except it is admitted that notice was posted on each claim on January 1, 1905; and as a further and separate answer defendants allege that at all times mentioned in the complaint, and for years prior thereto, one Charles

Lay was the general manager of the Whalen Consolidated Copper Mining Company, and directed and managed the affairs of said corporation with the consent of his co-owners of the shares of its capital stock, and with the consent of his said co-owners, and representing himself and said co-owners, during the year 1904 conspired with the complainant to make the locations of the several mining claims described in the bill of complaint on January 1, 1905, and that said attempted locations and relocations of said mining claims were made for the purpose of defrauding and cheating said Daniel Davies, defendant, out of the sums of money found due him as set forth in the bill of complaint.

Upon the issues thus tendered testimony was taken, and a final decree entered by the Circuit Court, dismissing the bill of complaint and dissolving the temporary injunction. *Wailes v. Davies* (C. C.) 158 Fed. 667.

It appears that the Whalen Consolidated Copper Mining Company was a corporation organized under the laws of the state of Illinois, with its principal office located in Chicago; that during the years 1901, 1902, and 1903 one Charles Lay, a stockholder in the corporation, had the necessary work done on the claims in controversy to prevent a forfeiture; that the expense incurred in doing this work during those years was met by Lay and some of the other stockholders. The court made no findings in the decree, but in the opinion filed in the case the court found that no labor had been performed or improvements made on six of the claims during the year 1904, that the amount of labor or improvements required by law had not been performed or made with respect to two of the claims during that year, and that with respect to these eight claims there was no evidence showing that work had been performed on other ground tending to develop or benefit these eight claims.

With respect to the three remaining claims the court found that Charles Lay, who was a stockholder in the Whalen Consolidated Copper Mining Company, owning 22,000 shares out of 100,000 shares of the capital stock of the corporation, performed the necessary amount of labor during the year 1904 to prevent the forfeiture of these three claims. Lay had testified that there was no work done by the Whalen Consolidated Copper Mining Company upon the claims in the year 1904, that the work he did was not assessment work for the company, and it was claimed in this behalf that Lay was merely a trespasser upon these claims in the year 1904. But the court concluded, from the facts stated in the opinion, that Lay as a stockholder had such a beneficial interest in the corporate property that the work performed by him on the claims was representative work, and inured to the benefit of the corporation, and prevented a forfeiture of the claims. The Court found, further, that the complainant, in relocating the claims on January 1, 1905, was only acting a part assigned to him in a scheme devised by Lay, and executed and carried out by Lay and two other stockholders of the corporation, and by another, who was the treasurer and trustee of an estate holding shares in the corporation. The purpose of this scheme was the transfer of these mining claims to complainant, who in turn was to transfer them to another corporation, in which Lay and his as-

sociates were stockholders, thereby delaying and defeating the judgment recovered by the defendant Davies against the Whalen Consolidated Copper Mining Company.

The court concluded, upon these and other facts stated in the opinion, that the purpose of complainant was fraudulent; that he did not come into equity with clean hands, and was not entitled to have a court of equity decree that a title acquired by such means was valid, thereby defeating the judgment recovered by the defendant Davies.

It is unnecessary to review the testimony in the case. A careful examination of it in detail convinces us that it fully supports the facts found in the opinion of the court and justifies the decree in favor of the defendant.

The decree is accordingly affirmed.

MONTANA CENT. RY. CO. v. UNITED STATES.
(Circuit Court of Appeals, Ninth Circuit. October 5, 1908.)

No. 1,558.

1. CARRIERS (§ 211*)—INTERSTATE CARRIERS OF LIVE STOCK—TWENTY-EIGHT HOUR LAW.

Act June 29, 1906, c. 3594, § 1, 34 Stat. 607 (U. S. Comp. St. Supp. 1907, p. 918), known as the 28-hour law, which prohibits interstate carriers of live stock from keeping the same confined for a period longer than 28 consecutive hours without unloading for rest, water, and feeding, and which subjects a carrier knowingly and willfully violating its provisions to a penalty, to be recovered by a civil suit, is not a criminal statute, nor subject to the strict rules of construction or of evidence applied in criminal prosecutions.

[Ed. Note.—For other cases, see Carriers, Dec. Dig. § 211.*]

2. CARRIERS (§ 211*)—TWENTY-EIGHT HOUR LAW—ACTION FOR VIOLATION—DEFENSES.

In an action against a railroad company to recover the penalty for knowingly and willfully violating such act, it is not a defense that such violation was by reason of the "oversight, forgetfulness, and unintentional neglect" of its train dispatchers, contrary to its rules and orders.

[Ed. Note.—For other cases, see Carriers, Dec. Dig. § 211.*]

In Error to the District Court of the United States, for the District of Montana.

This action was brought by the government to enforce a penalty growing out of the alleged violation of Act Cong. June 29, 1906, c. 3594, 34 Stat. 607 (U. S. Comp. St. Supp. 1907, p. 918) to prevent cruelty to animals, commonly known as the "Twenty-Eight Hour Law." The plaintiff in error is a Montana corporation, and at the time in question owned and operated a railroad from a point near Great Falls to the city of Butte, in that state. Since the sole defense interposed by the defendant to the action is presented by its answer, a demurrer to which the court below sustained, the only question presented is as to the sufficiency of the answer. The facts set up by that pleading are that on the 23d of November, 1906, Corey Bros., of Montana, delivered to the defendant railway company about 60 horses, at its station of Armington, in that state, to be by it and its connecting carriers transported to Twin Falls in Idaho. The horses constituted part of a train load of live stock consisting of 41 cars. The loading of the train was commenced about 9 o'clock in the morning of the day mentioned; but, although the loading of the train was conducted diligently and without negligence on the part of either the ship-

*For other cases see same topic & § NUMBER in Dec. & Am. Digs. 1907 to date, & Rep'r Indexes

pers or the carriers, it was not completed, and could not, with due diligence, have been completed, before 8 o'clock of the evening of that day. Because of certain unavoidable delays, the train did not leave Armington until 7:30 a. m. of November 24th, at which time it started and was conducted with reasonable diligence and dispatch as far as the defendant company's station of Clancy, in Jefferson county, Mont., arriving at that station at 8 o'clock in the evening of November 24th—the horses having then been in the cars of the defendant company for no greater period of time than 24 hours since the completion of the loading of the train at Armington. The train, including the cars containing the horses, was not unloaded at Clancy, nor were the horses fed or watered there, and the train did not leave that station until 1 o'clock in the morning of November 25th, at which time the horses had been confined in the cars for a period of 29 hours since the loading of the train had been completed at Armington; nor was the train unloaded at the city of Butte until 10:30 o'clock a. m. of November 25th. The answer alleges that long prior to the time when the shipment in question was made the defendant company had duly issued a formal and printed circular known as "Circular No. 1,149," addressed to all its agents, in and by which the agents were notified of the precise provisions, conditions, and requirements of the act of Congress relating to the interstate transportation of animals, and required to conform strictly to all of its provisions; and the company had also, before the time of the shipment in question, issued a special typewritten circular, signed by its superintendent, and known as "Circular No. 21," addressed to all agents, yardmasters, and others concerned, in and by which last-mentioned circular the company again gave notice to each of its employes of the precise requirements of the said act of Congress, and required strict and full compliance with all of its provisions by each of its employes, a copy of both of which circulars the company caused to be placed on all bulletin boards at each of its terminals, for the information, guidance, and instruction of all trainmen and other employes in any way connected with the loading, unloading or transportation of live stock, or the operation of trains containing such stock. The answer also alleges that the defendant company necessarily intrusted the control and movement of all trains, including the one containing the horses in question, to the supervision and direction of its chief dispatchers and assistant dispatchers at Great Falls, Mont., where its principal office and its division headquarters are located, and alleges that said dispatchers had, long before the time of the shipment in question, been furnished with a printed copy of the said act of Congress, and had been directed in writing to at all times conform to the provisions of that statute, and to so direct and control the movement of live stock trains as to always insure the unloading of live stock for rest, feed, and water in the manner and within the periods prescribed by the said law; that through the oversight, forgetfulness, and unintentional neglect of the said dispatchers, and not otherwise, no notice was given to the company's agent at the station of Clancy that a train containing live stock was being transported over the company's railroad, and no authority or direction was given by any of the said dispatchers for the unloading of the said stock at the said station; that the said live stock was under those circumstances confined on the defendant company's cars for a longer period than 28 hours without being unloaded for rest, water, and feeding, and that the failure to so unload was not prevented by storm or other accidental or unavoidable causes which could not have been anticipated or avoided by the exercise of due diligence and foresight on the part of the defendant company's employes, nor were the said animals carried in cars in which they had or could conveniently have had proper feed, water, and opportunity to rest; that by reason of those conditions and occurrences the present action was instituted by the government against the defendant company to recover the sum of \$500 as a penalty prescribed by the said act of Congress, and for the costs of such suit.

The act of Congress of June 29, 1906, is entitled "An act to prevent cruelty to animals while in transit by railroad or other means of transportation from one state or territory or the District of Columbia into or through another state or territory of the District of Columbia, and repealing sections forty-three hundred and eighty-six, forty-three hundred and eighty-seven, forty-three

hundred and eighty-eight, forty-three hundred and eighty-nine, and forty-three hundred and ninety of the United States Revised Statutes," the first, second, third, and fourth sections of which are as follows:

"Section 1. That no railroad, express company, car company, common carrier other than by water, or the receiver, trustee, or lessee of any of them, whose road forms any part of a line of road over which cattle, sheep, swine, or other animals shall be conveyed from one state or territory or the District of Columbia into or through another state or territory or the District of Columbia, or the owners or masters of steam, sailing, or other vessels carrying or transporting cattle, sheep, swine, or other animals from one state or territory or the District of Columbia into or through another state or territory or the District of Columbia, shall confine the same in cars, boats, or vessels of any description for a period longer than twenty-eight consecutive hours without unloading the same in a humane manner, into properly equipped pens for rest, water, and feeding, for a period of at least five consecutive hours, unless prevented by storm or by other accidental or unavoidable causes which cannot be anticipated or avoided by the exercise of due diligence and foresight: Provided, that upon the written request of the owner or person in custody of that particular shipment, which written request shall be separate and apart from any printed bill of lading, or other railroad form, the time of confinement may be extended to thirty-six hours. In estimating such confinement, the time consumed in loading and unloading shall not be considered, but the time during which the animals have been confined without such rest or food or water on connecting roads shall be included, it being the intent of this act to prohibit their continuous confinement beyond the period of twenty-eight hours, except upon the contingencies hereinbefore stated: Provided, that it shall not be required that sheep be unloaded in the nighttime, but where the time expires in the nighttime in case of sheep the same may continue in transit to a suitable place for unloading, subject to the aforesaid limitation of thirty-six hours.

"Sec. 2. That animals so unloaded shall be properly fed and watered during such rest either by the owner or person having the custody thereof, or in case of his default in so doing, then by the railroad, express company, car company, common carrier other than by water, or the receiver, trustee, or lessee of any of them, or by the owners or masters of boats or vessels transporting the same, at the reasonable expense of the owner or person in custody thereof, and such railroad, express company, car company, common carrier other than by water, receiver, trustee, or lessee of any of them, owners or masters, shall in such case have a lien upon such animals for food, care, and custody furnished, collectible at their destination in the same manner as the transportation charges are collected, and shall not be liable for any detention of such animals when such detention is of reasonable duration, to enable compliance with section one of this act; but nothing in this section shall be construed to prevent the owner or shipper or animals from furnishing food therefor, if he so desires.

"Sec. 3. That any railroad, express company, car company, common carrier other than by water, or the receiver, trustee, or lessee of any of them, or the master or owner of any steam, sailing, or other vessel who knowingly and willfully fails to comply with the provisions of the two preceding sections shall for every such failure be liable for and forfeit and pay a penalty of not less than one hundred nor more than five hundred dollars: Provided, that when animals are carried in cars, boats, or other vessels in which they can and do have proper food, water, space, and opportunity to rest the provisions in regard to their being unloaded shall not apply.

"Sec. 4. That the penalty created by the preceding section shall be recovered by civil action in the name of the United States in the Circuit or District Court holden within the district where the violation may have been committed or the person or corporation resides or carries on business; and it shall be the duty of United States attorneys to prosecute all violations of this act reported by the Secretary of Agriculture, or which come to their notice or knowledge by other means."

I. Parker Veazey, for plaintiff in error.
Carl Rasch, U. S. Atty.

Before GILBERT, ROSS, and MORROW, Circuit Judges.

ROSS, Circuit Judge (after stating the facts as above). From the foregoing statement it will be seen that the answer itself expressly alleges that the horses in question were confined on the company's cars for a longer period than 28 hours without being unloaded for rest, water, or feeding, and that its failure to so unload them was not caused by storm, or other accidental or unavoidable causes, which could not have been anticipated or avoided by the exercise of due diligence and foresight on the part of the company's employes, and that the horses were not carried in cars in which they had, or could conveniently have had, feed, water, or opportunity to rest. The answer further expressly alleges that the cause of this violation of the provisions of the statute was that:

"By and through the oversight, forgetfulness, and unintentional neglect of said dispatchers, and not otherwise, no notice was given to the defendant's agent at said station of Clancy that a train containing live stock was being transported over defendant's line, and would arrive at said station, and no authority or direction was given by said dispatchers for the unloading of said stock at said station."

The sole defense is that the statute imposes the penalty only on the carrier "who knowingly and willfully" fails to comply with its provisions; and it is earnestly contended for the plaintiff in error that the company here did not "knowingly and willfully" confine the horses for the time and under the circumstances stated. Its counsel insists that the case if not a criminal one, is at least of a criminal nature, and that to it should be applied the same strict rules of construction and of evidence which are applied in criminal prosecutions. In that position he is supported by the cases of the United States v. Louisville & N. R. R. Co. (D. C.) 157 Fed. 979, and United States v. Illinois Central Railroad Company (D. C.) 156 Fed. 182. But we are unable to take that view of the matter. We do not understand the statute to make a violation of its provisions a crime. It is true that a penalty is imposed for its violation, but the penalty is a pecuniary one only, which Congress expressly provided shall be recovered by civil action in the name of the United States, having, as we think, the ordinary incidents of a civil action. This view is in accord with that taken of the same and of a similar statute in the cases of United States v. Southern Pacific Railroad Company (D. C.) 157 Fed. 459, United States v. Central of Georgia Railway Company (D. C.) 157 Fed. 895, United States v. Philadelphia & Reading Railway Company (D. C.) 160 Fed. 696, and United States v. Baltimore & O. S. W. Railroad Company (C. C. A.) 159 Fed. 33.

The company, being a corporation, could, of course, only act through agents, and its answer expressly alleges that the horses in question were confined on its cars in violation of the statute by reason of the "oversight, forgetfulness, and unintentional neglect" of its train dispatchers. As was held by the court below, we think the facts expressly

alleged in the answer negative the claim that the failure to rest, feed, and water the horses was not the result of knowledge and willfulness on the part of the company. It knew through its agents, and through them only could know, that the horses were loaded on its cars, when their transportation commenced, where it should rest, water, and feed them as required by the statute, instead of doing which it, through its agents, continued to carry them in its cars longer than the statutory period of 28 hours without rest feed, or water. When the company did this, according to its own averments, by and through the only means it transported or could transport them at all, namely, its agents, we do not think it can be heard to say that it did not do so "knowingly and willfully."

The judgment is affirmed.

WILLIAMSBURGH CITY FIRE INS. CO. OF BROOKLYN v. WILLARD.†

(Circuit Court of Appeals, Ninth Circuit. October 5, 1908.)

No. 1,586.

1. INSURANCE (§ 146*)—CONSTRUCTION OF POLICY—MEANING OF WORDS USED.
Words used in a policy of insurance should be given their common, ordinary meaning, rather than that of the lexicographers or of those skilled in the niceties of language.
[Ed. Note.—For other cases, see Insurance, Cent. Dig. § 294; Dec. Dig. § 146.*]
2. INSURANCE (§ 421*) — EXCEPTION OF FIRES "OCCASIONED" BY EARTHQUAKE — "CAUSED"—"BY OR THROUGH"—"DIRECTLY OR INDIRECTLY."
A policy insuring the owner of property "against all direct loss or damage by fire except as hereinafter provided" contained a provision that the company should "not be liable for loss caused directly or indirectly by invasion, * * * or for loss or damage occasioned by or through any * * * earthquakes." *Held*, that the words "directly or indirectly" did not apply to the provision respecting earthquakes; that, construing such provision most strongly against the insurer in accordance with the settled rule, and giving the words their common, ordinary meaning, the word "occasioned" was equivalent to "caused," and the phrase "by or through" was but a repetition of words meaning the same thing, so that the provision excepted only loss or damage caused directly by earthquake, and that a loss indirectly caused by the progress of a fire from a distance, although originally started by an earthquake, was not within the exemption.
[Ed. Note.—For other cases, see Insurance, Dec. Dig. § 421.*
For other definitions, see Words and Phrases, vol. 2, pp. 1012-1013; vol. 8, pp. 7597-7598; vol. 6, pp. 4896-4897.]
3. INSURANCE (§ 421*)—CALIFORNIA STATUTE—"SPECIALLY EXCEPTED."
The insurer is not exempted from liability in such case by Civ. Code Cal. § 2628, which provides that, "when a peril is specially excepted in a contract of insurance, a loss which would not have occurred but for such peril is thereby excepted, although the immediate cause of the loss was a peril which was not excepted," since the peril "specially excepted" is fire directly caused by earthquake, and it was not the intention of the statute to create an exemption wider than that stipulated for by the parties.
[Ed. Note.—For other cases, see Insurance, Dec. Dig. § 421.*]

*For other cases see same topic & § NUMBER in Dec. & Am. Digs. 1907 to date. & Rep'r Indexes

†Rehearing denied November 6, 1908.

In Error to the Circuit Court of the United States for the Northern District of California.

T. C. Van Ness (Ralph C. Harrison, of counsel), for plaintiff in error.

L. L. Solomons and L. A. Redman, for defendant in error.

Charles S. Wheeler, J. F. Bowie, and H. U. Brandenstein, amici curiæ.

Before GILBERT, ROSS, and MORROW, Circuit Judges.

GILBERT, Circuit Judge. The court below held the plaintiff in error, the Williamsburgh City Fire Insurance Company of Brooklyn, N. Y., liable upon a fire insurance policy. By the terms of the policy the property of the defendant in error was insured "against all direct loss or damage by fire except as hereinafter provided." After setting forth the amount of the insurance, with a description of the property and certain other provisions not material to the question here involved, the following clause was added:

"This company shall not be liable for loss caused directly or indirectly by invasion, insurrection, riot, civil war, or commotion, or military or usurped power, or by order of any civil authority; or for loss or damage occasioned by or through any volcano, earthquake, or hurricane, or other eruption, convulsion, or disturbance, or by theft, or by neglect of the insured to use all reasonable means to save and preserve the property at and after a fire, or when the property is endangered by fire in neighboring premises, or (unless fire ensues and in that event for the damage by fire only) by explosion or any kind of lightning; but liability for direct damage by lightning may be assumed by agreement indorsed hereon."

The property of the insured was consumed in a general conflagration in San Francisco, which had its origin in the earthquake of April 18, 1906. The fire was started at several points in the city other than that at which the insured property was situated, and spread until it reached the insured property. It is the contention of the plaintiff in error that, since the fire which destroyed the property can be traced back through a number of buildings to a fire started by the earthquake, liability therefor is excluded by the policy. The single question before the court is whether that contention is sustained by the true construction of the terms of the policy. The insurance is against all direct loss or damage by fire with the exceptions stated in the clause above set forth. The first exception is liability for loss caused directly or indirectly by invasion, etc. Then occurs a change of phraseology, and instead of excepting liability for loss caused directly or indirectly by volcano, earthquake, etc., the language used is "or for loss or damage occasioned by or through any volcano, earthquake," etc. Standing by itself and without reference to preceding clauses of the insurance policy, the plain meaning of this clause would be that the insurer does not assume liability for loss or damage occasioned by any of the violent disturbances of nature so enumerated; but, as it is explicitly stated in the policy that the insurance is only against direct loss or damage by fire, there must be read into the clause under consideration the words "by fire," so that it shall read, "or for loss or damage by fire occasioned by or through any volcano, earthquake, or hurricane," etc.,

for it must be that the sole purpose of the exception is to specify certain losses by fire not insured against. This is especially true when we take into consideration the fact that the policy begins with the statement that the insurance is "against all direct loss by fire except as hereinafter provided." The rules of construction require that, if possible, a meaning shall be given to every provision of the contract. To say that the exception refers to destruction of insured property, from earthquake or other physical causes named is to give no meaning to the exception and to reject it as surplusage.

The plaintiff in error contends that the words "occasioned by or through" are equivalent in meaning to the words "caused directly or indirectly by," since "to occasion" by strict definition does not mean to act as a cause in producing effect, but "to cause incidentally or indirectly," "to bring about or be the means of bringing about," etc. It is true that this distinction of meaning is to be found in the definitions of these words by the lexicographers; but it is equally true, and this is also sustained by the dictionaries, that in common and colloquial use the words "cause" and "occasion" are used synonymously. Such, in fact, is their ordinary use. Words used in a policy of insurance should be given their common, ordinary meaning, rather than that of the lexicographers or of those skilled in the niceties of language. *Imperial Fire Insurance Co. v. Coos County*, 151 U. S. 463, 14 Sup. Ct. 379, 38 L. Ed. 231. Nor do we find any enlargement of the meaning of the clause from the use of the words "by or through." "By or through" is but the repetition of words meaning the same thing, and the effect is the same that it would be if either of those words have been used, instead of both. Upon the premise, then, that the exception in the policy is for loss or damage by fire caused by any volcano, earthquake, etc., we proceed to inquire whether the loss in this case is one for which liability is excluded under the policy.

The plaintiff in error particularly relies upon *Insurance Co. v. Tweed*, 7 Wall. 44, 19 L. Ed. 65, and *Insurance Co. v. Boon*, 95 U. S. 117, 24 L. Ed. 395. In the first of these cases the policy exempted the insurance company from liability for any loss which might happen or take place by means of any explosion. An explosion took place in a warehouse situated across the street from the insured property, and produced a fire which, facilitated by the direction of the wind, reached and consumed the insured property. The court held that the explosion was the proximate cause of the loss, because the fire extended at once to the insured property from the place of the explosion, and said that no new or intervening cause occurred between the explosion and the burning of the insured property, and that if such cause had intervened, sufficient of itself to stand as the cause of the misfortune, the other must have been considered as too remote. In *Insurance Co. v. Boon*, the doctrine of the *Tweed Case* was applied to a similar policy of insurance exempting the insurer from loss or damage by fire "which may happen or take place by means of any invasion, insurrection," etc. In citing the *Tweed Case* the court said:

"There it was, in effect, ruled that the efficient cause, the one that set others in motion, is the cause to which the loss is to be attributed, though

the other causes may follow it and operate more immediately in producing the disaster."

In *Scheffer v. Railroad Co.*, 105 U. S. 249, 26 L. Ed. 1070, Mr. Justice Miller, who had delivered the opinion in the *Tweed Case*, said of that case that:

"It went to the verge of sound doctrine in holding the explosion to be the proximate cause of the loss of the Alabama Warehouse; but it rested on the ground that no other proximate cause was found."

It is the doctrine of these decisions that if the excepted cause produce a fire in property near the property insured, and the fire is communicated to the latter by natural causes, the excepted cause is the proximate cause of the loss, and that the exceptions contained in the policies in those cases, phrased as they were, were sufficiently broad to exclude liability for loss by fire caused either directly or indirectly by the agencies so specified. The plaintiff in error also cites *Walker v. London & Provincial Fire Ins. Co.*, 22 Irish Law Times, 84. In that case the contract of fire insurance was made subject to the condition that the policy did not cover any loss or damage occasioned by or in consequence of incendiarism. The insured property was destroyed by a fire caused by incendiarism in an adjoining building. It was held that the word "incendiarism," as used in the policy, included any act of incendiarism, wherever committed, which directly caused the loss or damage sued for. Said Palles, C. B., in delivering the opinion of the court:

"The condition operates as an exception out of the generality of the description of fire contained in the body of the policy, and excludes from the risk damage resulting from willful, as distinguished from accidental, fires; and in my opinion the effect of the policy and the condition does not, for the purpose in hand, materially differ from that which it would have been if the words in the body of the policy had limited the risk to damage by fire not being incendiarism."

That case, however, goes no further than *Ætna Fire Ins. Co. v. Boon*. The construction of the exemption in the policy was not affected by the previous use of the words "directly or indirectly." No expression was used to show the intention to limit the exemption to incendiarism committed on the property described in the policy. This was expressly held in the opinion.

The foregoing decisions would control the construction of the policy in the present case if the exception therein as to liability for loss occasioned by volcano, earthquake, etc., stood by itself, unaffected by the language of the exception which immediately precedes it. The purpose of the policy being to insure against loss by fire, an exception of liability for fire loss should be plainly expressed. If it had been the intention of the policy to exclude liability for all loss by fire caused by earthquake, it would have been a plain and simple matter to express that intention in the words used in the first section. Had that been done, no question of construction could have arisen under the facts in the present case. But the difference in the phraseology is so marked and significant as to compel the conclusion that it was intentional. The insurer took pains to incorporate in the first exception exemption from

liability for loss caused directly or indirectly by invasion, insurrection, etc., and to omit the words "directly or indirectly" from the second. Having thus in the first exception excluded liability for loss resulting directly or indirectly from the causes specified, or, in other words, having stipulated for exemption from liability for loss through fire caused by invasion, etc., whether the fire originated on the property insured or was started elsewhere and communicated to it by the burning of intervening property, and having omitted the words "directly or indirectly" in the second exception, the natural inference is that the intention was to claim a narrower exemption from liability in the latter.

Applying the maxim that in construing the terms of an insurance policy, if there be any ambiguity, it must be construed most strongly against the insurers, since the language of the policy is their own, effect to that intention can only be given in the present case by holding that the second exception exempts only from liability for loss by fire which is caused directly by volcano, earthquake, etc., and that a loss indirectly caused by the progress of a fire from a distance, although originally started by an earthquake, is not within the exemption. *Baker & Hamilton v. Williamsburgh City Fire Ins. Co.* (C. C.) 157 Fed. 280. It is unnecessary, therefore, to enter into a discussion of the question whether the earthquake was or was not the proximate cause of the loss. Conceding that it was the procuring, efficient, predominating cause, it was not, nevertheless, the direct cause. It did not produce a fire on the insured premises. A contract such as we construe this one to be was not unreasonable or inconsistent with the usual course of business of an insurance company. An earthquake, unaided by other agencies, produces no fire. It evidently was not the intention of the contracting parties that the insured was to answer for the default of others whose buildings might be improperly constructed or defectively wired, or, by reason of the purposes for which they were used, were specially subject to fire by the disturbing agency of an earthquake.

While the question of the construction of the policy has necessarily been resolved upon a consideration of its own phraseology, in the light of the subject-matter of the contract, assistance has been found in the principles announced in the following decisions: In *Hustace v. Insurance Co.*, 175 N. Y. 292, 67 N. E. 592, 62 L. R. A. 651, the policy provided for liability only for loss directly caused by fire. A fire caused an explosion which blew down the insured premises, which were located a short distance from the place of the explosion. The court held that the direct cause of the loss was the explosion, and that there could be no recovery on the policy. In *German Fire Ins. Co. v. Roost*, 55 Ohio St. 581, 45 N. E. 1097, 36 L. R. A. 236, 60 Am. St. Rep. 711, the insurance excluded loss by explosion unless fire ensued, but specially insured against loss or damage by lightning. Lightning struck a powder magazine on the opposite side of the street and caused an explosion which wrecked the insured property. It was held that the loss was caused by the explosion, and not by lightning, and that the insurance company was not liable. In *Boatmen's Fire Ins. Co. v. Parker*, 23 Ohio St. 85, 13 Am. Rep. 228, the policy provided that the company should not be liable for damages occasioned by the explosion of a steam boiler, nor for damages resulting from such explosion,

nor for damages caused by the explosion of gunpowder. The court held that the words "resulting from such explosion" had no application to the latter clause of the sentence, and that the damage resulting from explosion caused by gunpowder was not excluded, citing *Hare v. Horton*, 5 B. & Ad. 715, in which was involved the construction of a mortgage upon "dwellings, foundries, and other premises, together with all fixtures in the dwelling house," and in which the court held that although, if there had been no specifications of fixtures in the dwelling house, the fixtures in the foundries would have passed by the mortgage, yet by the use of those words the fixtures intended to pass were confined to those in the dwelling house. So in *Commercial Ins. Co. v. Robinson*, 64 Ill. 265, 16 Am. Rep. 557, on a policy providing that the company shall not be liable "for any loss or damage by fire caused by means of an invasion, * * * nor for any loss caused by the explosion of gunpowder." The court held that the words "by fire" could not be read into the latter clause, and held that the exemption should be confined to loss caused by explosion without fire, and said:

"The difference in phraseology between the two clauses is so marked that when we consider their connection with each other, we cannot resist the conclusion that the difference was intended."

The plaintiff in error cites and relies on section 2628 of the Civil Code of California, which provides as follows:

"When a peril is specially excepted in a contract of insurance, a loss which would not have occurred but for such peril is thereby excepted, although the immediate cause of the loss was a peril which was not excepted."

As we understand the statute, it has no bearing upon the question of the construction of the policy in the present case. The "peril specially excepted" here is fire directly caused by earthquake. For a loss so caused the insurer shall not be liable. But the loss did not occur from a fire directly caused by earthquake. To hold that the insurance company, although it has specially provided for exemption of liability for loss by fire directly caused by earthquake, is entitled to an exemption wider than that which it stipulated for, is to hold that the intention of the statute is to deny to the contracting parties the power to make the contract which they made—a purpose not to be imputed to the lawmakers, and, indeed, one which is expressly disavowed in section 3268, which declares that the provisions of the Code in respect to the rights and obligations of parties to contracts (including section 2628)—

"are subordinate to the intention of the parties when ascertained in the manner prescribed by the chapter on the Interpretation of Contracts; and the benefit thereof may be waived by any party entitled thereto, unless such waiver would be against public policy."

The judgment is affirmed.

HAMBLE v. ATCHISON, T. & S. F. RY. CO.

(Circuit Court of Appeals, Ninth Circuit. October 5, 1908.)

No. 1,543.

1. RAILROADS (§ 261*)—JOINT USE OF TRACKS—LIABILITY FOR INJURY FROM NEGLIGENT OPERATION OF TRAINS.

Where the trains of one railroad company in charge of its own employes run over the tracks of another company under a contract that they shall obey the orders of the train dispatcher of the latter company, such contract does not relieve the company so using the tracks from liability for injuries caused to third persons by the negligence of its employes operating its trains in no way attributable to any order of the train dispatcher.

[Ed. Note.—For other cases, see Railroads, Cent. Dig. §§ 825, 826; Dec. Dig. § 261.*]

2. MASTER AND SERVANT (§ 193*)—FELLOW SERVANTS—SERVANTS OF SEPARATE MASTERS IN SAME WORK.

An employe of a railroad company does not by virtue of his contract of service assume the risk of injury from the negligence of the servants of another company jointly using the tracks of his employer, but has the same right of action against such company for an injury so occurring as any stranger.

[Ed. Note.—For other cases, see Master and Servant, Dec. Dig. § 193.*]

In Error to the Circuit Court of the United States for the Southern Division of the Southern District of California.

The plaintiff in error brought an action in the court below to recover damages for personal injuries suffered by him as the result of a rear-end collision between two railway trains. The complaint alleged that the accident was occasioned by the negligence of the defendant in error in operating one of the trains. The answer denied negligence, and alleged contributory negligence on the part of the plaintiff in error, and for a further defense alleged in substance that the railway upon which the accident occurred belonged to the Southern Pacific Railroad Company, and that the defendant in error was using the same by virtue of a license from the Southern Pacific Company, authorizing it to run and operate its engines, cars, and trains thereon, and that the operation and movement of all engines, cars, and trains of the defendant in error thereon was to be subject to the immediate direction, government, and superintendence of said Southern Pacific Company, and that the train so alleged to have been negligently operated by the defendant in error was, at the time of the accident, under the sole direction, control, and government of the Southern Pacific Company and its agents. The evidence showed that the plaintiff in error was a conductor in the employment of the Southern Pacific Company, and had charge of its freight train No. 2,602, bound from Los Angeles to Bakersfield. The accident occurred at about 6:25 in the morning. The plaintiff in error had crossed the summit of the Tehachapi Mountains, and running in a westerly direction on a downhill grade, had passed through tunnel No. 5, and about 20 minutes before the accident had reached a point where the rear end of his train, including the caboose, stood in the westerly end of tunnel No. 4, where his train stood until the time of the accident, for the reason that the track ahead of him was obstructed by other trains so that he could not proceed. The distance between the two tunnels is about 2,750 feet. The track from No. 5 to No. 4 runs on a downgrade of about 120 feet to the mile, and the whole course of it is plainly visible from the westerly end of No. 5. The track was equipped with an efficient system of automatic block signals, which were in working order. The plaintiff in error and his train crew adopted the usual methods and devices required by the rules in such cases to prevent a rear-end collision. Immediately on coming to a

*For other cases see same topic & § NUMBER in Dec. & Am. Digs. 1907 to date, & Rep'r Indexes

standstill, a brakeman went back up the road and strapped to the rails at different intervals between the tunnels four torpedoes, and ignited two fusees, which were stuck into the ties at points where they were most likely to be seen by an overtaking train, and one of the fusees was still burning after the accident. The overtaking train consisted of two heavy engines and a caboose belonging to the defendant in error and one light engine at the front end of the train belonging to the Southern Pacific Company. It was in charge of a conductor of the defendant in error, but the engineer of the Southern Pacific engine was in the employment of the Southern Pacific Company. The plaintiff in error knew that this train was following him. His orders required him to look out for a train ahead and a train behind. He received these orders at Summit Station, from the Southern Pacific train dispatcher. There is no evidence that either train disregarded in any way the instructions of the train dispatcher. The evidence shows that the overtaking train passed the danger signal showing red at the easterly limit of the block on which the plaintiff in error's train was standing. This signal was a mile up the grade and above the easterly end of tunnel No. 6. After passing this signal, the defendant in error's train came out of the west end of tunnel No. 5 at a speed of from 25 to 30 miles an hour, came down the grade at that speed, exploding the four torpedoes, passing over the burning fusees, passing the signaling brakeman Smith, and the yellow caution light near the easterly mouth of tunnel No. 4, thence into collision with the rear end of the plaintiff in error's train. At the close of the evidence for the plaintiff in error, the defendant in error moved for a nonsuit, which was granted on the ground that the overtaking train, from the time it left Summit Station, was under the control and direction of the Southern Pacific Company, and not of the defendant in error. That ruling is assigned as error.

Harris & Harris and F. W. Thompson (Newman Jones, of counsel), for plaintiff in error.

E. W. Camp, A. H. Van Cott, and U. T. Clotfelter, for defendant in error.

Before GILBERT, ROSS, and MORROW, Circuit Judges.

GILBERT, Circuit Judge (after stating the facts as above). The record shows that the defendant in error was in the joint use with the Southern Pacific Railroad Company of a portion of the latter's track under a license, and that its trains were under the control and direction of the Southern Pacific Company. The trains that came into collision had started from Summit Station under the direction of the Southern Pacific Company's train dispatcher at Bakersfield. It is to be admitted that a railroad company operating its trains over the road of another under a license to use the same, and subject to the direction of the latter and the rules and regulations of its road, is not answerable for injury occurring to third persons through the negligent acts of the train dispatcher or other officers in whose charge is the management and the control of the movement of trains. But when the injury occurs to a third person through the negligent act of the employes of the licensed company, not resulting from any negligent order as to the movement of trains, but wholly through the negligence of the conductor in charge of a train of the licensed company, is that company liable therefor? That is the question which this case presents.

The decisions involving the proposition are not numerous, and they are contradictory. The court below followed the rule laid down in *Atwood v. Chicago, R. I. & P. Ry. Co.* (C. C.) 72 Fed. 447. In that case both the railroad companies were made parties defendant, and the negligence alleged by the plaintiff was that the receivers of the

Union Pacific Company negligently and carelessly permitted a Rock Island train to leave Lawrence within five minutes after the departure of a train of the Union Pacific. The evidence, however, tended to show that, after the Rock Island train left Lawrence, the employes in charge of it, knowing that the Union Pacific train was in front, could, by the exercise of due care, have avoided the accident. The court ruled that the plaintiff could recover only by proof of the negligence alleged in the complaint, and that as there was nothing to justify a finding that the Union Pacific Company started the trains from Lawrence too close together, or that such act, if proved, was the proximate cause of the injury, there was no ground for holding that company liable for the injury, and as to the Rock Island Company, the court held that as the contract provided that the Union Pacific Company should have the exclusive right to make rules for the operation of that part of the road used by the parties jointly, and that all trains should move in accordance with the order of its superintendent, and since the Rock Island Company had no right or power to direct movements of its trains while on the track, it could not be held responsible to third parties, on the doctrine of respondeat superior, for any negligence of the men in charge of the train while running over such track, though they were in its employment and paid by it. This ruling was based upon the ground that the master was at the time without the power to control the act of the imputed servant; that power being taken from the Rock Island Company and conferred upon the Union Pacific Company by the contract under which trains were operated, "the rules and regulations of which," said the court, "placed the management of the trains, the whole manner of their operation, the speed at which they shall run, under the management of the Union Pacific Railroad Company. They prescribe how they shall approach other trains, the distance to be observed between trains while occupying the same track going in the same direction, and the safeguards that each must throw out and the circumspection and vigilance each shall exercise. And," continued the court, "the party who failed to observe these rules and regulations was violating the rules and regulations of the Union Pacific Railway Company, and the defendant, the Rock Island Company, was without the power or authority under its contract to give a single direction."

On the other hand, in *Clark v. Geer*, 86 Fed. 447, 32 C. C. A. 295, the Circuit Court of Appeals for the Eighth Circuit, by Thayer, Circuit Judge, held that where the trains of one company, in charge of its own employes, run over the track of another company, under a contract that they shall obey the orders of the train dispatcher of the latter company, such contract does not release the company so using the track from liability for injuries caused by the negligence of its employes, and that a master cannot claim exemption from liability for damages occasioned by the negligent act of his servant, committed while in his immediate service and doing his work, merely because he has empowered a third party to give that servant directions relative to certain matters connected with the doing of the work. In that case the action was brought against the Rock Island Company and the receivers of the Union Pacific Company. The injury occurred to a

passenger on a freight train of the Union Pacific Company, which was run into at the rear end by a freight train of the Rock Island Company. The complaint alleged that the injury was occasioned by the negligence of both railway companies, and by the negligence of the Rock Island Company in particular, in the failure of its engineer in charge of its freight train to keep a proper lookout ahead, and the failure on his part to discover at an earlier moment, as he ought to have done, the red lights on the rear end of the Union Pacific train. There was a verdict and judgment against both companies in the court below. The appellate court, after referring to the fact that no attempt was made to hold the Rock Island Company responsible, because an improper order had been given to its engineer by the train dispatcher of the Union Pacific Company, or that the latter had failed to make reasonable regulations for the movement of trains over the track which was used jointly, and to the presumption that the jury found that the engineer of the Rock Island Company was negligent as charged in the complaint, observed:

"Can it be said, then, that the Rock Island Company can claim exemption from liability for negligent acts of such a character which were in no way attributable to the conduct of the train dispatcher of the Union Pacific Company, subject to whose orders the Rock Island Company had for the time being placed its engineers? We are constrained to hold that this question should be answered in the negative. It may be conceded that a servant may at the same time be in the general employ of one master and in the special service of another, and that if, while in such special service and under the exclusive control of the special master and doing his work, he is guilty of a negligent act, the special master is alone responsible therefor. * * * In the case now in hand, it appears that the persons who were in charge of the Rock Island train at the time of the collision were not engaged in the performance of any service for and in behalf of the Union Pacific Company, or in aiding that company in the performance of any service, but were doing the work of the Rock Island Company to the same extent as if the train in their charge had been at the time on the track of the latter company. We fail, therefore, to perceive any sufficient reason for exempting the Rock Island Company from liability for the negligent acts of its servants which are charged in the complaint, especially as the acts in question were not done by the direction of the Union Pacific Company, or in consequence of the failure of its train dispatcher to give any information or orders which he ought to have given."

The doctrine so announced in *Clark v. Geer* seems to us sound in principle and just. On what principle should the Southern Pacific Company be held liable for the negligence of the servants of another company in doing acts over which it had no control in fact? It cannot be said, with any due regard for the meaning of words, that the servants of the defendant in error were the servants of the Southern Pacific Company. Notwithstanding that they were on the road of the latter, they were at all times about their own master's business. They were not working for the Southern Pacific Company, or rendering that company any service. The most that can be said is that for the time being, while serving their own master, they were under the direction of the Southern Pacific Company as to certain prescribed regulations concerning the time of starting and stopping their trains and the rules of the road, regulations essentially necessary for the safety of the trains of both companies. In all other respects they remained the servants of the company in whose service they were, by

which they were hired and discharged, and from which they received their compensation.

In *Philadelphia & Reading R. R. Co. v. Derby*, 14 How. 468-486, 14 L. Ed. 502, it was said:

"The rule of respondeat superior, or that the master shall be civilly liable for the tortious acts of his servant, is of universal application, whether the act be one of omission or commission, whether negligent, fraudulent, or deceitful. If it be done in the course of his employment, the master is liable, and it makes no difference that the master did not authorize or even know of the servant's act or neglect, or even if he disapproved or forbade it. He is equally liable if the act be done in the course of his servant's employment."

The test of the master's liability, therefore, is whether the act done by the servant was, at the time and place, done in the course of the servant's employment and while the servant was under the master's control, and he is under the master's control at all times while the master has the right to control him, whether he exercise control or not. The servants of the Santa Fé Company, in operating their trains, were in the general employment of that company, and subject to its control. They were not subject to the control of the Southern Pacific Company, except as to certain specified acts. In all other respects they were answerable to their master. The Southern Pacific Company had no power to hire or discharge them, or to compel them to exercise care in operating their master's trains. No diligence on the part of that company, as far as the record before us shows, could have averted the accident. To avoid liability the original master must resign full control of the servant for the time being. It is not sufficient that the servant is partially under the control of another. *Garven v. C., R. I. & P. Ry. Co.*, 100 Mo. App. 617, 75 S. W. 193; *Chicago, R. I. & P. Co. v. Groves*, 56 Kan. 601, 44 Pac. 628; *Chicago, R. I. & P. Co. v. Martin*, 59 Kan. 437, 53 Pac. 461; *Sullivan v. Tioga R. R. Co.*, 112 N. Y. 643, 20 N. E. 569, 8 Am. St. Rep. 793; *Roganville Lumber Co. v. Gulf, B. & K. G. Ry. Co.*, 36 Tex. Civ. App. 563, 82 S. W. 816; *Chicago, R. I. & P. Ry. Co. v. Posten*, 59 Kan. 449, 53 Pac. 465. In the case last cited the court said:

"For keeping the tracks and other Union Pacific property in repair, the Union Pacific Company is primarily responsible; but for the conduct, skill, and diligence of the trainmen in the operation of trains of the Rock Island Company it clearly is answerable both to its own passengers and to all others affected thereby. The negligence for which the Rock Island was held liable was the negligence of the engineer and other trainmen employed by it and in charge of its train. We are not called on to consider any question concerning its liability for the negligence or mismanagement of train dispatchers, telegraph operators, switchmen, or other persons employed by the Union Pacific, but whose duties relate to the trains of both companies. It is clear that the Rock Island is responsible for the conduct of its employes in the operation of its trains over the Union Pacific tracks, and that the management of Rock Island trains by employes of the Union Pacific Company is confined to orders and regulations in reference to their movements."

In *Sullivan v. Tioga R. R. Co.*, 112 N. Y. 643, 20 N. E. 569, 8 Am. St. Rep. 793, the plaintiff, who was in the employment of one railroad company, was injured through the negligence of the employes of another company jointly using the same track. Of such negligence the court said:

"Their negligence was not one of the risks which, by virtue of his contract of service, he had taken upon himself. He was at no time under the authority of the defendant, nor in any respect its servant. He neither owed service to it, nor did he render it. * * * The intestate was, in respect to his employment, a stranger to the defendant. He was merely at work in a yard to which, by permission of his employer, the defendants by its servants had access. He was removing ashes from the pit; they, running an engine over a part of it to reach the turntable; and the duties of each were so limited, neither was responsible to the master of the other for the manner of the performance. There was no common master, and although, having regard to the place of service, they were neighbors, they were not co-servants. Each, therefore, is entitled to protection against the negligence of the other."

The liability of the defendant in error is not affected by the fact that one of the engines attached to its train belonged to the Southern Pacific Company and was operated by an engineer of that company. The evidence shows that, to avoid loss of time between signal blocks, the train dispatcher had directed the conductor of the train to attach the Southern Pacific engine and bring it to Kern Junction. Notwithstanding the presence of this engine, the train remained in the control of the conductor. He was responsible for the speed at which it was run. He admitted that he ran the train carelessly, and that while running at the rate of 30 miles an hour he saw a danger signal, and that he was negligent in permitting the engineer to run at the speed at which the train was going.

The judgment is reversed, and the cause is remanded for a new trial.

In re HORGAN et al. In re REAGAN. ELDREDGE et al. v. HORGAN et al.

(Circuit Court of Appeals, First Circuit. May 1, 1908.)

No. 765 (Original).

BANKRUPTCY (§ 293*) — PROCEEDING BY TRUSTEE — JURISDICTION — ADVERSE CLAIMANT.

Trustees of a bankrupt filed a summary petition in the court of bankruptcy against sureties on a bail bond given by the bankrupt prior to the bankruptcy, to recover money deposited with them to secure them against liability on the bond. The sureties appeared and objected to the jurisdiction, and set up an agreement between them and the bankrupt, when the deposit was made, that they should defend any litigation over the money deposited and pay all charges incurred therefor from the deposit; that a prior petition to require them to pay over the money had been filed by the marshal, as receiver in bankruptcy, which they had contested, and which was dismissed for want of jurisdiction; and they claimed the amount expended by them in such defense from the fund. *Held*, that such claim was really adverse to that of the trustees, based on rights antedating the bankruptcy, and the court was without jurisdiction to determine it without the consent of the proposed defendants, under Bankr. Act July 1, 1898, c. 541, § 23b, 30 Stat. 552 (U. S. Comp. St. 1901, p. 3431), as amended by Act Feb. 5, 1903, c. 487, 32 Stat. 798 (U. S. Comp. St. Supp. 1907, p. 1028).

[Ed. Note.—For other cases, see Bankruptcy, Cent. Dig. § 411; Dec. Dig. § 293.*

Jurisdiction of federal courts in suits relating to bankruptcy, see note to *Bailey v. Mosher*, 11 C. C. A. 313.]

*For other cases see same topic & § NUMBER in Dec. & Am. Digs. 1907 to date, & Rep'r Indexes

Petition to Review.

Patrick P. Curran (Richard B. Comstock and Comstock & Canning, on the brief), for petitioners.

J. Jerome Hahn and Ralph T. Barnefield (Vincent, Boss & Barnefield, on the brief), for respondents.

Before COLT, PUTNAM and LOWELL, Circuit Judges.

LOWELL, Circuit Judge. After the decision of this court rendered December 20, 1907, and reported in 158 Fed. 774, the suit brought by Armour against the bankrupt was discontinued, and thereupon the trustees in bankruptcy brought a summary petition in the District Court against the sureties on the bond, praying that they might be ordered to deliver to the trustees the \$12,000 deposited with the sureties by the bankrupt. The sureties appeared in the District Court for the purpose of objecting to its jurisdiction in the matter, and filed affidavits in which they deposed that, at the time of their becoming sureties, it was agreed between them and the bankrupt that they should "undertake the defense of any litigation over the money deposited with" them, and "should pay out of said sum * * * all charges for professional services and disbursements in connection with the defense of any action which might grow out of (their) having received the said sum." The affidavits alleged, further, that they had paid out for these purposes \$1,209.90, which sum ought to be repaid them from the deposit of \$12,000 in their hands. After hearing the parties, the District Court made an order directing the respondent sureties to pay over to the trustees \$10,500 on March 9, 1908, and the rest of the deposit March 16, 1908. The sum of \$10,500 was thereupon paid to the trustees without objection, and is not here brought into controversy. Concerning the rest of the deposit, the petitioners filed an original petition in this court, seeking to review the action of the District Court, upon the ground that it was without jurisdiction in the case.

But one question is here presented: Was the petitioners' claim to the sum here in controversy, \$1,500 and interest, a claim really adverse to the claim of the trustees in bankruptcy or merely colorable so? The District Court had jurisdiction to pass upon this question; but, if the claim was really adverse, the court was without jurisdiction to proceed further under section 23 of the bankruptcy act (Act July 1, 1898, c. 541, 30 Stat. 552 [U. S. Comp. St. 1901, p. 3431]) as modified by the Ray bill (Act Feb. 5, 1903, c. 487, § 8, 32 Stat. 798 [U. S. Comp. St. Supp. 1907, p. 1028]). Whether the lien claimed by the petitioners be deemed to arise by implication of law out of the deposit with them of security for their liability on the bail bond, or from the express contract set up in their affidavits, we are of opinion that their claim to the lien was not so clearly without foundation as to be merely colorable within the decisions of the Supreme Court. *Louisville Trust Co. v. Comingor*, 184 U. S. 18, 22 Sup. Ct. 293, 46 L. Ed. 413; *First Nat. Bank v. Title & Trust Co.*, 198 U. S. 280, 25 Sup. Ct. 693, 49 L. Ed. 1051. To pass upon the validity of the petitioners' claim, a court must deal with a somewhat intricate question of law and with

a disputed question of fact. The trustees contend, indeed, that the expenditures for which the petitioners seek reimbursement were incurred after bankruptcy, and that they did not benefit the bankrupt estate. In some cases these conditions might defeat a claim for reimbursement. Here the petitioners' claim to the deposit at the time of the earlier proceeding was decided to be adverse; i. e., to be made not merely on behalf of the bankrupt and in his interest. This adverse claim the petitioners were not required to abandon without a contest. While the expense which was incurred in protecting their claim was incurred after bankruptcy, yet the petitioners' lien for reimbursement of the expense was inchoate before bankruptcy. It is true that the expense did not benefit the bankrupt estate; but, considering that it was incurred in resisting the proceeding of the trustees to recover the deposit in a court without jurisdiction of the controversy, the trustees cannot say that it was incurred so wantonly as to make the claim for its reimbursement merely colorable—i. e., a claim made without any substantial basis. We are not called upon to hold the petitioners' claim to be valid, and we do not so hold. We merely hold it to be really adverse to the claim of the trustees in bankruptcy. Without discussing whether the form of proceeding by way of summary petition would have been suitable if the District Court had had any jurisdiction of the controversy, we hold that the jurisdiction of that court was altogether excluded by section 23 of the bankruptcy act as interpreted by the decisions above cited.

The decree of the District Court is reversed, with costs for the petitioners in this court.

BELL v. CARTER et al.

(Circuit Court of Appeals, Eighth Circuit. October 8, 1908.)

No. 2,668.

1. TRIAL (§ 141*)—QUESTION FOR COURT OR JURY—DIRECTION OF VERDICT.

Whilst it is true that a substantial conflict in the evidence must be determined by the jury as a question of fact, it is also true that when the evidence is undisputed, or is so clearly preponderant that it reasonably admits of but one conclusion, the proper disposition of the case upon the evidence becomes a question of law, to be determined by the court.

[Ed. Note.—For other cases, see Trial, Cent. Dig. § 336; Dec. Dig. § 141.*]

2. TROVER AND CONVERSION (§ 9*)—PROPERTY TAKEN FROM PRISONER BY SHERIFF—CONVERSION—DEMAND.

A sheriff, who takes from a prisoner in his custody property rightly belonging to the prisoner and thereafter surrenders it to another, in disregard of the prisoner's rights and in recognition of an adverse claim asserted by another, is guilty of a conversion, and becomes liable in trover, without any precedent demand for a return of the property.

[Ed. Note.—For other cases, see Trover and Conversion, Cent. Dig. §§ 60, 61; Dec. Dig. § 9.*]

(Syllabus by the Court.)

In Error to the Circuit Court of the United States for the District of Colorado.

*For other cases see same topic & § NUMBER in Dec. & Am. Digs. 1907 to date, & Rep'r Indexes
164 F.—27

Ralph Talbot (Edward J. Boughton, J. H. Denison, and William H. Wadley, on the brief), for plaintiff in error.

A. R. Morrison (R. S. Morrison and Emilio D. De Soto, on the brief), for defendants in error.

Before VAN DEVANTER and ADAMS, Circuit Judges, and PHILIPS, District Judge.

VAN DEVANTER, Circuit Judge. This was an action of trover for the alleged conversion of a gold ingot and 20 sacks of crushed gold and silver ores. At the trial, which was to a jury, the evidence, without any conflict, established these facts: The defendant was the sheriff of Teller county, Colo., and as such took the plaintiffs into custody upon a charge of larceny, which was subsequently dismissed. At the time of their arrest the plaintiffs had with them the ingot and ores and were the rightful owners thereof. The defendant took this property into his possession and custody, insisting that it was stolen, and then turned it over to one Burbridge, who was the secretary of the Cripple Creek District Mine Owners' & Operators' Association. Burbridge delivered the ores to the Eagle Ore Sampling Company, and shortly thereafter it disposed of them at the direction of the Mine Owners' & Operators' Association and paid to the latter the full value of them. Subsequently, when the criminal charge was dismissed, the plaintiffs commenced an action against the defendant in the district court of Teller county to compel the redelivery to them of the specific ingot and ores so taken from them. In that action the defendant answered under his personal oath, alleging that the property never belonged to the plaintiffs, that their possession had been without right and unlawful, that after the property came into his possession he delivered it to the Mine Owners' & Operators' Association as the agent of the real owner, and that the property had thus passed out of his custody and into the hands of its true and lawful owner. Without further pursuing their action for a redelivery, the plaintiffs then commenced the present action, charging an unlawful conversion of the property by the defendant. He answered with a general denial.

Apart from a dispute respecting the value of the property, the only possible conflict in the evidence related to the nature and purpose of the delivery to Burbridge. The Circuit Court was of opinion that the evidence, reasonably interpreted, admitted of but one conclusion; that is, that the delivery to Burbridge was intended to be, and was, a delivery to the Mine Owners' & Operators' Association, and was intended to be, and was, a repudiation of the claim of the plaintiffs, and a recognition of the adverse claim of another, of whom the association was claiming to be the agent. A verdict for the plaintiffs was accordingly directed, only the question of value being submitted to the jury.

Without questioning that the verdict was rightly directed, if the evidence reasonably admitted of no other conclusion than the one stated, the defendant insists that there was evidence which made the nature and purpose of the delivery to Burbridge a question of fact for the jury. It becomes necessary, therefore, to consider whether there

was a substantial conflict in the evidence on that point. If so, the insistence is well taken; otherwise, it is untenable. Whilst it is true that a substantial conflict in the evidence must be determined by the jury as a question of fact, it is also true that when the evidence is undisputed, or is so clearly preponderant that it reasonably admits of but one conclusion, the proper disposition of the case upon the evidence becomes a question of law, to be determined by the court. *Robinson v. Denver City Tramway Co.* (C. C. A.) 164 Fed. 174, and cases cited.

The chief item of evidence bearing upon the question under consideration was the defendant's declaration, in his sworn answer in the prior proceeding, that he had delivered the property to the Mine Owners' & Operators' Association as the agent of another claimant, whom he described as "its true and lawful owner." Of course, that deliberate and solemn declaration could not be easily overcome or lightly disregarded. His attention was directed to it when he was testifying in his own behalf, and all that he could say about it was that he did not remember making it. The substance of his other testimony, which was somewhat contradictory, is embodied in the following extract from his cross-examination:

"Q. What date did you deliver this (the property in question) over to the Mine Owners' Association? A. The same day it arrived in Cripple Creek. Q. The very day? A. Yes, sir. Q. Then it had been arranged in advance that it should be delivered to them as soon as it got there, had it? A. No, sir. Q. How did it come to happen, then, on the same day that you delivered it? A. In taking the ore from the express company's office I met Col. Burbridge, as I said awhile ago. Q. He was the secretary of this association? A. Yes, sir. Q. You say you delivered it to him simply for safe-keeping? A. I turned it over to him, and it was with the understanding that it was to go to the Eagle Ore Sampling Company's vault for safe-keeping, as I had no safe in which to keep it."

Other answers given by him indicated that, shortly after he delivered the property to Burbridge, he was looking to the Mine Owners' & Operators' Association, rather than to the Sampling Company, for indemnification, if he met with loss by reason of what was done. One of his witnesses, a deputy sheriff, testified that he put the sacks of ore in the Sampling Company's vault at the direction of Burbridge, and also turned over to him the gold ingot; and another of his witnesses, the manager of the Sampling Company, testified that that company received the ore from the Mine Owners' & Operators' Association and did not know the defendant in the transaction, that the ore was disposed of at the direction of the association and payment therefor was made to it, that the course pursued was the same as in other cases where ore had been seized by the association, and that the gold ingot was not delivered to the Sampling Company. There was no evidence that Burbridge was a suitable person to be charged with the safe-keeping of the property, or that he had any official connection with the Sampling Company, or that he had actual or apparent authority to speak for it, or that the defendant exacted from him or it a receipt acknowledging that the property was received for safe-keeping merely. Burbridge was not called as a witness, and it was conceded

that the gold ingot went to the Mine Owners' & Operators' Association, and not to the Sampling Company.

From this recital of all the evidence upon the subject it is apparent that the conflict therein respecting the nature and purpose of the delivery to Burbridge resulted from the conflicting statements in the personal testimony of the defendant, and that but for his statement, repeated two or three times, that that delivery was upon the understanding that the property was to be placed in the vault of the Sampling Company for safe-keeping the evidence would all have been the other way. That statement is not only without corroboration, but is altogether inconsistent with his statement that he turned the property over to the Mine Owners' & Operators' Association on the very day that he reached Cripple Creek with the prisoners and the property, is inconsistent with his conduct at the time and shortly thereafter, is inconsistent with his deliberate and solemn declaration in his sworn answer in the other case, is inconsistent with what was actually done by Burbridge, the association and the Sampling Company, and is inconsistent with the reasonable purport and effect of the testimony of the deputy sheriff and the manager of the Sampling Company. In that situation we think that the conflict in the evidence was unsubstantial and that, reasonably considered, the evidence that the delivery was actually to the Mine Owners' & Operators' Association, and was in disregard of the plaintiffs' claim and in recognition of an adverse claim, was so clearly preponderant that no other conclusion was reasonably admissible.

It is also said that, as the defendant lawfully came into possession of the property, he could not be charged with conversion in the absence of a proper demand for its return. Ordinarily that would be so; but when such a custodian delivers the property to another in disregard of the rights of the owner, and so puts it out of his power to return it, he makes a demand unnecessary. 2 Cooley on Torts (3d Ed.) 870 et seq.; 1 Chitty on Pleadings (16th Am. Ed.) *178.

As it follows that a verdict for the plaintiffs was rightly directed, the judgment is affirmed.

HARDESTY et al. v. UNITED STATES.

(Circuit Court of Appeals, Sixth Circuit. November 2, 1908.)

No. 1,802.

CRIMINAL LAW (§ 394*)—EVIDENCE—EVIDENCE UNLAWFULLY OBTAINED.

It is no objection to the admissibility of evidence which is pertinent to the issue in a criminal case that it was obtained by means of a search warrant illegally issued or executed.

[Ed. Note.—For other cases, see Criminal Law, Cent. Dig. § 875; Dec. Dig. § 394.*]

In Error to the District Court of the United States for the Western District of Tennessee.

*For other cases see same topic & § NUMBER in Dec. & Am. Digs. 1907 to date, & Rep'r Indexes

Henry M. Johnson, for plaintiffs in error.
George Randolph, for the United States.

Before LURTON, SEVERENS, and RICHARDS, Circuit Judges.

PER CURIAM. We have given this case careful consideration, and fail to find any ground upon which the judgment should be reversed. The evidence elicited through the use of a search warrant, and to which objection was made, was admissible, however irregular the search warrant may have been, and however improper its use for the purpose of securing evidence. *Adams v. New York*, 192 U. S. 585, 24 Sup. Ct. 372, 48 L. Ed. 575. Aside from this, the warrant is not in evidence, and no error has been assigned in relation to it, or the evidence which was discovered by its use. It is admissible for this court to consider a plain error though not assigned. No such appears in respect of any illegal use of a search warrant.

Judgment affirmed.

WILFLEY et al. v. NEW STANDARD CONCENTRATOR CO. et al.

(Circuit Court of Appeals, Ninth Circuit. October 12, 1908.)

No. 1,566.

1. CONTRACTS (§ 335*)—ACTION FOR BREACH—SUFFICIENCY OF COMPLAINT.

Under Civ. Code Cal. § 1439, which provides that, before any party to an obligation can require another party to perform any act under it, he must fulfill all conditions precedent thereto imposed on himself, and must be able to, and offer to, fulfill all conditions concurrent so imposed on him on like fulfillment by the other party, a complaint in an action by a licensor under a patent to recover royalties from the licensee does not state a cause of action, where the contract contains a covenant by the plaintiff to protect the licensee from infringements of the patent, and the complaint neither alleges performance nor offers to perform such concurrent condition.

[Ed. Note.—For other cases, see Contracts, Cent. Dig. §§ 1664, 1667, 1668; Dec. Dig. § 335.*]

2. PATENTS (§ 219*)—LICENSE—ACTION TO RECOVER ROYALTIES—DEFENSES.

Where an exclusive license under a patent is coupled with an express covenant by the licensor to protect the exclusive right so granted, a breach of such covenant by the failure to prosecute known infringers of the patent and by licensing others thereunder is sufficient to defeat the recovery of any royalties contracted to be paid by the licensee.

[Ed. Note.—For other cases, see Patents, Cent. Dig. § 340; Dec. Dig. § 219.*]

In Error to the Circuit Court of the United States for the Southern Division of the Southern District of California.

The plaintiffs in error sued the defendants in error to recover royalties under a license made on November 21, 1901, authorizing the defendants in error to make and sell concentrating tables under the Wilfley patent, owned and controlled by the plaintiffs in error. The complaint alleged that in consideration of such license the defendants in error agreed to pay the plaintiffs in error

*For other cases see same topic & § NUMBER in Dec. & Am. Digs. 1907 to date, & Rep'r Indexes

certain royalties on the 1st day of each calendar month, and to make reports of the number of tables so made and sold thereunder; that the defendants in error had made and sold a large number of tables under the contract, but had failed to pay royalties or to make reports, with the exception that 56 tables had been reported to have been made between February 10, 1902, and September 11, 1903; and that there were royalties still due on 250 tables, amounting to \$18,750. The complaint did not set forth the terms of the contract, nor allege that the plaintiffs in error had upon their part performed the same.

The answer denied indebtedness to the plaintiffs in error and set forth the contract in hæc verba, the substance of which is as follows: It recites that the plaintiffs in error are the owners of certain exclusive rights under letters patent granted to Wilfley on September 28, 1897, and that the defendants in error are the assignees of the patent granted to Luther Look, of date July 16, 1901; that the defendants in error had been notified that their patent infringed certain claims of the Wilfley patent; that on November 5, 1901, a decree had been made by the United States Circuit Court at Denver, establishing the validity of the Wilfley patent, which covers the form of construction used by the defendants in error under the Look patent; that the defendants in error desire to continue to manufacture tables under the Look patent; that the Wilfley patent is prior to and covers the form of construction described in the Look patent. By the terms of the contract the plaintiffs in error acknowledged full settlement and compensation on account of all damages sustained by them prior thereto, by reason of the manufacture and sale of any and all ore-concentrating tables made by the defendants in error under the Look patent, and granted a license to the defendants in error to continue to manufacture such tables in accordance with the specifications of the Look patent, the license to continue during the life of the Wilfley patent, and covenanted that the license should be exclusive, except as to certain specified reservations, in consideration of which the defendants in error agreed to pay a royalty upon all tables made and sold by them for the first two years of \$50 for each, and thereafter of \$75 for each, and they granted to the plaintiffs in error the right to use and sell a certain improvement in sand pumps used and belonging to the defendants in error. The plaintiffs in error further covenanted at their own expense and cost to take all necessary and reasonable steps to protect the claims of the Wilfley patent, and the rights of the defendants in error thereto, by virtue of the license so granted, and to prosecute infringers thereof. The answer then proceeded to allege in detail the failure of the plaintiffs in error to comply with the covenant to protect the patent and to prosecute the infringers thereof. It alleged that the plaintiffs in error licensed one Woodbury to make and sell tables at a less royalty than that agreed upon in the contract, and that they have permitted the Joshua Hendry Machine Works, the Union Iron Works, Hendry & Bolthoff, the American Engineering Company, and others to infringe the Wilfley patent and the rights of the defendants in error thereunder, and under the said license and contract, and that with the full knowledge of such facts the plaintiffs in error have refused to protect the defendants in error in any manner, or to prosecute said infringers, although often requested so to do, and that such breaches by the plaintiffs in error of such contract have been continuing for three years or more prior to the commencement of the suit.

To these defenses the plaintiffs in error demurred, and the demurrers were overruled. When the case came on for trial the plaintiffs in error introduced in evidence the contract, a copy of which had been set out in the answer, and offered to prove the breaches thereof alleged in the complaint. The defendants in error objected to the introduction of further evidence on the ground that the contract thus admitted by the plaintiffs in error showed that the complaint stated no cause of action, for the reason that it contained no allegation that the plaintiffs in error had on their part performed the contract. Counsel for plaintiffs in error having stated that he proposed to offer no other evidence than the contract itself, and evidence of the breaches of the same as alleged in the complaint, the court sustained the objection and ordered judgment for the defendants in error.

Hodges & Wilson, Henry T. Sale, and George L. Hodges, for plaintiffs in error.

Frederick S. Lyon, for defendants in error.

Before GILBERT, ROSS, and MORROW, Circuit Judges.

GILBERT, Circuit Judge (after stating the facts as above). It is contended that the Circuit Court erred in overruling the demurrers to the defense alleged in the answer, and in refusing to allow the plaintiffs in error to introduce evidence to prove the breaches of the contract alleged in the complaint. It is argued that the covenant of the defendants in error to pay the stipulated royalties is not conditional, in that it is not expressed as being conditioned upon the performance of the covenant to protect the exclusive rights so granted them, but is absolute in its terms; that the mutual covenants in the contract do not go to the whole of the consideration on both sides; that they are therefore not mutual conditions; and that the covenant to protect the licensee goes only to a part of the consideration, the breach of which may be paid for in damages, and the performance of which need not be pleaded as a condition precedent to the recovery of the stipulated royalties.

We do not so regard the contract. Section 1439 of the Civil Code of California provides that, before any party to an obligation can require another party to perform any act under it, he must fulfill all conditions precedent thereto imposed upon himself, and he must be able to, and offer to, fulfill all conditions concurrent so imposed upon him on the like fulfillment by the other party, and section 1437 defines "conditions concurrent" to be "those which are mutually dependent and are to be performed at the same time." *Barron v. Frink*, 30 Cal. 486, holds that if the contract sued on is executory, and each party has something to perform before the other can be completely in default, the party who seeks to enforce it against the other must aver in his complaint a performance, or tender of performance, or readiness to perform, on his part. In this case there can be no question that the covenant to guard the claims of the Wilfley patent and the rights granted the licensee thereunder, and to prosecute infringers, was a concurrent condition, to be complied with at all times during the life of the license. A license implies that the licensee shall not be evicted from its enjoyment, and such an eviction is a defense to a suit for royalties accruing after it occurred. *Walker on Patents* (4th Ed.) § 307. In 3 *Robinson on Patents*, § 1241, it is said:

"A breach of warranty may constitute an entire or partial defense to an action for the purchase money, according to the nature of the broken covenant. The implied warranty of title and the express warranty of validity are of the essence of the contract, and a breach of these relieves the assignee from all his obligations. Other covenants may have the same or a more limited effect, to be determined by the extent to which their nonfulfillment impairs the value of the patent to the assignee. If the infraction is equivalent to a total failure of the consideration for the promise of the assignee to pay the price, or if the price cannot be apportioned between the advantage he receives from the conveyance and that of which he is deprived by the breach of warranty, the action of the assignor must fail."

In *Angier v. Eaton, Cole & Burnham Co.*, 98 Pa. 594, 42 Am. Rep. 624, the court held that the right under such a license was in the nature of a monopoly, and that so long as it was enjoyed by the licensee he was bound to pay the consideration therefor, but that when, by reason of something beyond his control, he was deprived of that exclusive right, there was a failure of consideration. In *Edison Elec. Co. v. Thackara Mfg. Co.*, 167 Pa. 530, 31 Atl. 856, it was held that, where a licensee is enjoying the benefit of a patent, he is bound to pay the stipulated royalty, and cannot set up as a defense the actual invalidity of the patent; but when, in addition to the invalidity of the patent by reason of a prior outstanding patent, it is shown that the owner of the prior patent is asserting his exclusive rights thereunder by supplying the market with the patented article, and the licensee under the invalid patent is deprived of the monopoly for which he contracted, he may defend against an action to recover the royalty on the ground of the failure of consideration. The principle involved in those decisions is applicable to the present case; for, where one who has agreed to pay royalties for an exclusive right under a license is deprived of that right, it is immaterial whether his eviction occurred through the acts of one who had a prior patent for the same improvement, or through the default or act of his licensor in violating a covenant to protect the exclusive rights so granted and to prevent infringement thereof, thereby depriving him of the substance of that for which he contracted to pay royalties.

Cases are cited which hold that if, in the grant of a license to use and vend a patented invention, there is no express covenant that the licensor will protect the licensee from infringement, no such covenant will be implied to defeat the licensor's right to recover the stipulated royalties. *McKay v. Smith* (C. C.) 39 Fed. 556; *National Rubber Co. v. Boston Rubber Shoe Co.* (C. C.) 41 Fed. 48; *Standard Button Fastening Co. v. Ellis*, 159 Mass. 448, 34 N. E. 682. But it is the clear inference to be drawn from these decisions that, if the license is coupled with an express covenant on the part of the licensors to protect the exclusive right so granted, the breach of such covenant is sufficient to defeat recovery.

The license here purported to be an exclusive one. Its very exclusiveness was the substance of the thing granted. It was of the essence of that for which the defendants in error agreed to pay royalties. It was coupled with a covenant to protect the licensees in the exclusive use of the rights so granted. There has been a total breach of that covenant. The licensors, instead of affording the promised protection, have by their own acts in effect reappropriated to their own use that which they granted the licensee. In short, their course was such that the licensee was evicted from the granted right immediately after the execution of the license, and the eviction was continuous until the commencement of the suit. The plaintiffs in error having failed to set up the contract in their complaint, and the defendants in error having pleaded the same according to its terms, and the plaintiffs in error having announced their intention to rest their case on the proof of the contract and evidence of the nonpayment of the royalties, the situation is the same that it would be, had the contract

been set up in full in the complaint. Unless a complaint on such a contract alleges performance of the covenant to protect the granted right, it fails to state a cause of action.

The judgment is affirmed.

THOMSON-HOUSTON ELECTRIC CO. v. TRACTION EQUIPMENT CO.
GENERAL ELECTRIC CO. v. SAME.

(Circuit Court, E. D. New York. July 31, 1908.)

1. PATENTS (§ 328*)—INFRINGEMENT—RHEOSTATS FOR ELECTRIC CARS.

The Wightman patent, No. 411,947, for a rheostat for use on electric railway cars, was not anticipated, and discloses patentable invention, but is not of such broad scope as to cover the use of any material in any form in the construction of a resistance pile, and is not infringed by the structure of the Lundie patent, No. 687,569, in which cast-iron plates or grids are used in contact only by means of hubs thereon.

[Ed. Note.—For other cases, see Patents, Dec. Dig. § 328.*]

2. PATENTS (§ 328*)—INFRINGEMENT—RHEOSTATS FOR ELECTRIC CARS.

The Short patent, No. 459,794, for a rheostat for use on electric railway cars, discloses patentable invention in the manner of construction of the pile and the idea of making flues through the same by so fastening the sheets together as to cause perforations through the same to register, but not in the manner of fastening them by the use of nonconducting pencils or insulated bolts, and is not infringed by the device of the Lundie patent, in which air spaces for cooling purposes are provided between the plates.

[Ed. Note.—For other cases, see Patents, Dec. Dig. § 328.*]

In Equity. On final hearing.

Betts, Sheffield & Betts (L. F. H. Betts, of counsel), for complainant.
Collin, Wells & Hughes (George H. Gilman and Thomas Ewing, Jr., of counsel), for defendant.

CHATFIELD, District Judge. The above actions are based upon alleged infringements of patents. The two cases arise from the use by the defendant in both cases of the same device, and have been tried and argued together, although the record has been separately completed, and neither case is dependent upon the other. But for apparent reasons the cases will be treated together in this decision, and duplication can be thus avoided.

The device, the use of which is involved in the actions, is called in the various patents, and by most of the witnesses, a rheostat. The definitions given by the experts will be referred to subsequently; but in order to form a basis for the legal questions involved, and in order to avoid purely mechanical terms, a general statement, from the standpoint of an individual other than an electrical engineer, may be useful. The adaptation of electricity as a power for propelling street cars by means of motors, receiving the electrical current from a feed or supply wire, and, in fact, experiments, even, upon any plan useful for practical application, are a matter of recent development.

According to the testimony in this case, the first electric street car in the United States, operating by means of a motor, was run by one

*For other cases see same topic & § NUMBER in Dec. & Am. Digs. 1907 to date, & Rep'r Indexes

E. M. Bentley, at the works of the Brush Electric Company, Cleveland, Ohio, and upon a mile of track in that city, during the years 1883 and 1884. The experiments at Cleveland continued through the year 1885, and in 1887 the Thomson-Houston Company entered into the electric railway business. In 1889 this company purchased an interest in the Bentley-Knight Company, which had been following up the inventions of Mr. Bentley, in 1883, and as a result of the experiments of the Thomson-Houston Company the Wightman patent, No. 411,947, on which the first of these suits is based, was obtained. The precise date of the Wightman patent is October 1, 1889, upon an application filed July 5, 1889, and in general the Wightman patent was for a rheostat or electrical resistances to be used in situations "where a bulky and cumbersome apparatus could not be readily employed—as, for instance, under electric street cars." In the ten years between 1890 and 1900, rapid and widespread advance was made both in the construction and in the operation of street railways with cars run by electric motors, in the form generally known as "trolley cars."

The Short patent, upon which is based the second suit, was granted upon the 22d day of September, 1891, upon an application filed March 17, 1891, and is stated to relate to "adjustable rheostats or rheostatic-current regulators used on electrically-propelled cars or vehicles." The Case patent was of much later date, having been granted on November 18, 1902, upon an application filed May 10, 1901, and the Case invention is stated to relate "to improvements upon the generic type of resistance device shown in the patent to Short, No. 459,794." The invention is stated to consist in a "construction and arrangement whereby the rheostat is made light, adapted to be readily cooled, and to be mounted in a simple manner on the lower side of the floor of a railway car."

It may here be said that the defendant has acquired rights in another patent for rheostats, under date of November 26, 1901, No. 687,569, upon an application filed August 15, 1901, by John Lundie, and in this patent the invention is stated to relate "to rheostats for use in regulating the amount of current flowing through an electric circuit in which it is interposed, designed more especially for use in connection with electric motors used in traction systems."

The present actions were begun in 1903, and the record shows that the complainant in the first case, the Thomson-Houston Electric Company, has acquired the rights to the Wightman patent, and the complainant in the second action, the General Electric Company, has acquired the rights to the Short and Case patents, while the defendant, the Traction Equipment Company, as has been said, holds by assignment the rights under the Lundie patent. The complainant in each action has in general alleged infringement. The defendant has set up numerous defenses; but, before considering these separately, it is necessary to consider for a moment the general purpose and use of rheostats, so called, and the methods by which the object of their use has been accomplished in the various electric trolley lines. A point has now been reached where a comparatively similar style of rheostat seems to have been placed upon the market by most of the companies manufacturing them for this purpose.

In general, it is commonly understood that each trolley car, when operated by itself, receives an electric current from the feed or supply wire, which is transmitted through the electric motor, and there transformed in such a manner as to operate some form of gear by which the wheels of the car are driven. The voltage or intensity of the electric current at the supply or feed wire is constant, and the quantity of current, or the amount of current expressed in amperes, is also constant so far as each car is concerned. The current is let in to the motor by means of a controller or switch, and the various forms of controllers have been the basis of considerable litigation previously in the United States courts, during the course of which the use of rheostats has been defined and considered.

Assuming that the potential (or the voltage) and amperage of the electric current at the supply wire are constant, and that upon connection with the ground the current is dissipated or scattered at what may be called "zero potential," and assuming that there is current sufficient throughout the supply wire to give to each trolley car a constant current when in connection with the ground or return rail, it will be seen that a certain amount of electricity will pass through the trolley pole of each car, and through the motor of that car whenever connection is made by means of a switch or controller. If this electric current in each car is turned on to the electric motor suddenly, before the motor can fully assume its work and thus neutralize the strength of the current by the work done, a large amount of electrical energy must be transformed into heat by the resistance of the metal of the motor itself, and the effect of this would be disastrous upon the motor. Various devices have been used, intended to accomplish the result of relieving this defect, by way of absorbing or using up the energy of the current supplied through the trolley pole or contact shoe, and to give a gradual and relatively proportionate increase of current to the motor, until the motor of the car equalizes in work done the strength of the current. In the absence of some such device, the transformation of the current inside of the motor into heat, rather than the utilization of this heat in work, would destroy or render useless the motor itself.

The complainant's expert, Mr. Bentley, has defined this in the following way:

"I should state that a rheostat is a device designed to be interposed in an electric circuit to present a resistance to the flow of current therein. A rheostat accomplishes its function of diminishing or adjusting the current flowing in the circuit only at the expense of electrical energy, which is dissipated and wasted in the form of heat within the rheostat, instead of performing some normally useful purpose, such as the production of electric light or power, by the conversion of the electrical energy into light or into mechanical motion. The construction of a rheostat capable of practical service in circuits carrying heavy currents under high pressure—as, for example, an electric railway circuit—is a more or less difficult matter, in view of the large amount of heat which must be produced by the device and properly disposed of without injury thereto."

The defendant's expert says that rheostats are—"used to control a current by the resistance which they offer to its passage. The greater this resistance the less will be the strength of the current, with a

given electro-motive force or pressure. The resistance offered by a conductor is directly proportional to its length, inversely proportional to its cross-section, and depends also upon the nature of the material"—iron having considerably greater resistance than copper.

Having thus generally considered the purpose and use of a rheostat, let us consider briefly the three forms of this resistance exemplified by the Wightman, Short (and Case), and Lundie patents, before discussing other patents or the prior art.

The scope of the Wightman patent is stated in the claims of the patent to be:

"1. An electric-resistance pile consisting of alternate layers of conducting and insulating material, having the parts of each conducting-strip to either side of its center connected, respectively, to the two adjoining conducting-strips."

"5. An electric-resistance pile consisting of alternate sheets of mica and a conducting material, with the successive sheets of the conducting material in electrical contact."

"7. An electric-resistance pile consisting of alternate sheets or layers of mica and iron, having the successive sheets of iron in electrical connection."

The principle of this rheostat seems to have been to construct a compact pile or series of metallic plates occupying a small space, and by means of many sheets of insulating material, and by the use of slits or slots in each sheet of the conducting material, to compel the current to pursue an exceedingly long and zigzag path from one pole of this compact pile to the other. Bearing in mind that the object of the rheostat is to offer resistance by turning the electrical current into heat, it can immediately be seen that a large number of these compact piles, mounted side by side as Wightman planned, in a trough lined with insulating material, and with no conducting or cooling device, would but slowly and imperfectly accomplish the object of transforming a strong current of electricity into heat, dissipating this heat, and being ready to receive another current after a very short interval. The familiar illustration furnished by a motorman turning his controller back and forth, when a trolley car is proceeding slowly, with the brake on, thus sending the current through the motor and the resistance or rheostat many times a minute, is all that is necessary to point out the difficulties with which a rheostat constructed according to the Wightman patent would have to contend.

The Short patent attempted to remedy this defect by means of flues or air ducts through the resistance and the interposition of heat-conducting plates, of some material such as copper, projecting beyond the resistance plates, and thus affording radiation, together with a method of binding the pile or series of plates together, through pencils of some insulating material, such as slate, to be held by clamps or bolts at the ends of these pencils. The idea in the Short patent was to take away the box or trough in which Wightman packed his series, and to furnish some means by which the series could be attached to a street car and at the same time give as much opportunity as possible to the currents of air produced by the motion of the street car to act in a cooling manner upon the plates. The claims in the Short patent to which particular attention must be given are as follows:

"4. A resistance comprising an assemblage of plates strung on nonconducting pencils and clamped between heads or end plates, substantially as described."

"5. A rheostatic element comprising clamping-heads, clamping-bolts for the same, nonconducting pencils between said heads, and resistance-plates and insulating-plates strung on the pencils and clamped between the heads, substantially as described."

The Case patent was an advance in a similar construction, by which Mr. Case separated the greater part of the surface of the conducting elements in the Short patent from each other, thus leaving air spaces between these elements entirely without any insulating material, except at what are called in the patent the "supporting hubs," through which the insulating supporting rods passed.

Upon the trial of the action testimony was offered to show use in the years 1897 to 1899, by the Crocker-Wheeler Company, of Trenton, N. J., of an idea with reference to cast-iron plates or grids equipped with hubs, as the elements of resistance for various purposes in electrical work, the idea of which, as the testimony showed, had been obtained from the Sprague Elevator Company, and that Mr. Sprague, of this company, had used a cast-iron grid, fitted with a hub of the form in question, before the year 1896. This clearly antedated the Case patent, and although Sprague had never taken advantage of his idea, in the way of obtaining a patent, it became apparent that the patent issued to Case was invalidated by this prior use, and claim of infringement of the Case patent was therefore withdrawn.

The Lundie patent, of a date only a few days later than the Case patent, makes use as well of a cast-iron grid with a hub, and with insulating washers between alternating pairs of hubs, while metallic washers are used at the opposite ends of the grids, thus forming a cumulative magnetic field, much similar in general plan to the resistance field in the Case patent, so far as the arrangement of the path of the current, the contact through hubs, and the separation of the elements or grids (which Lundie calls "resistance units," and which Case calls "resistance grids") are concerned. In each of these patents the hubs are perforated, and an insulated rod passes through the different openings and holds the various units within the box or frame by a nut and thread, and every part of each insulated grid or each resistance unit is separated by an air space, except at the faces of the hubs, which bear a relatively small proportion to the flat lateral surfaces of the grid.

The greatest point of dissimilarity between the Lundie and the Case patent is that in the Lundie patent the resistance unit is in the form of a double spiral, with a hub at the center of each spiral, and with a third hub between these spirals; insulation being so inserted in the form of washers as to make this third hub purely a means of support and not of contact. In the Case patent the resistance grid consists of a plate in the form of a combination of successive letters "u," with a hub at the beginning, a second hub at the grid, and a third hub in the center; this third hub again being insulated and used merely for the purposes of support, and all three hubs in a line upon the same side of the box or frame within which the grids are bolted. The following diagrams will show sufficiently accurately the shape of these grids and sheets:

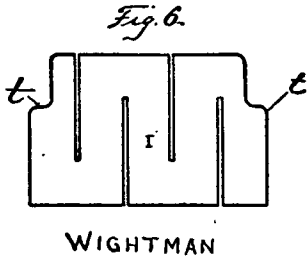

FIG. VI.

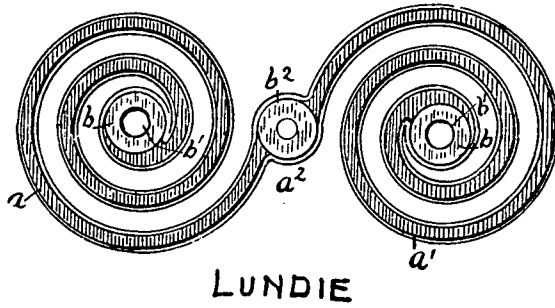
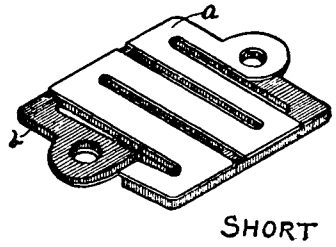
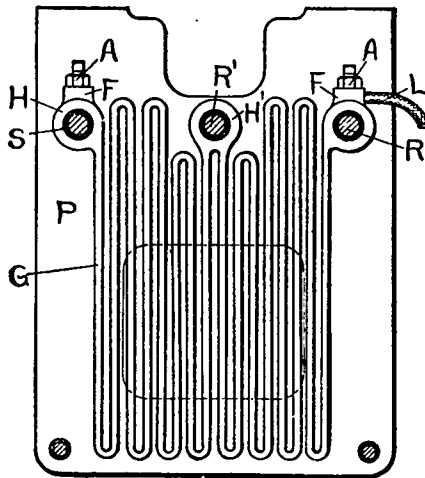

Fig. 2.



The construction in use by the defendant at the time of the bringing of this suit, and as to which infringement is claimed, leaves out the third or center hub of the Lundie patent, thus leaving out as well one set of insulating washers and one insulated rod.

In the Case patent the grids are stated to be composed "preferably of cast iron," while in the Lundie patent the spiral is stated to be intended to include "any form of wire or strip winding from the inside to the outside after the manner of a spiral"; but in actual use by the defendant the grids are also made of cast iron. In the Wightman and Short patents, the elements are stated to be "of iron," and are called "sheets," while it appears from the testimony that in the early experiments of Mr. Bentley cast-iron plates were fastened together in lateral contact in a compact mass, in such a way that the current passed through the mass from face to face of these plates; the resistance being increased and principally effected by the oxidization of the plates. In the Wightman, Short, Case, and Lundie patents the current follows from end to end, in the longest lineal direction, the successive lengths of the plates or grids, and thus makes use of an exactly contrary principle to that of the Bentley experiments, although the electrical resistance of the substance is in all of these rheostats (as in every device used for the purpose) the means of making use of or transforming the electrical current into heat.

The complainant contends that this idea or principle of an elongated path and of a large resistance, which is claimed to be in direct proportion to the length of the path, was novel and of itself an invention. The complainant also contends that when Wightman specified the use of iron in claim 7 of his patent as the material of which his elements were to be composed in one form of the structure covered by his invention, he thereby included all forms of iron whether wrought or cast. The defendant, on the other hand, contends that Wightman's patent, in its various claims referring to sheets, could not have contemplated plates or rods of greater thickness than would be capable of use in a compact pile with interlocking surfaces, and that, therefore, Wightman could not have had in mind nor anticipated the use of cast iron.

Mr. Bentley, the complainant's expert, has submitted a sketch to illustrate his theory that a cast-iron plate with a bend or shoulder near the extremity, by which the plates would be brought in contact on either side of the sheet of insulating material, would fulfill the conditions of the Wightman patent, and would show that under Wightman's claims cast-iron plates, as well as wrought-iron sheets, were covered and included. To disprove this theory the defendant relies not only upon the definition of the word "sheet" as distinguished from the definition of the word "plate" in dictionaries and text-books, but also refers to certain patents which illustrate the growth of the electrical art prior to the time of the Wightman patent, and has furnished the testimony of witnesses to fix the date at which cast iron was stated by those experimenting to have some seven or eight times the resistance of wrought iron. This date is fixed by these witnesses as 1895-96, some years subsequent to the Wightman patent. Short in his patent uses the word "plate," and there is nothing in the patent from which it can be determined that Mr. Short had in mind merely the

limited use of a thin sheet, although he describes his resistance as composed of plates "of, say, wrought iron"; and, on the contrary, there is nothing in the Short patent from which it can be inferred that at that time Mr. Short knew of or had experimented with the difference in resistance between wrought and cast iron.

The complainant also contends that the method specified by Short, and shown in his patent, of supporting the various plates by means of insulated pencils or pencils of nonconducting material, passing through the openings or perforations in the elements, and fastened with some bolting or clamping construction to the box or frame, which is substituted in the Short patent for the trough of the Wightman patent, is of itself an invention which is infringed by the use of the defendant's insulated rods for a similar purpose. The defendant alleges that the use of rods in this manner was not invention, but was an old and well-known mechanical device, used in many ways, and upon all kinds of structures, and that the idea of Short was to prevent the movement of the resistance elements laterally by insulating nonconducting rods through the perforations, and that the binding together of the elements, and the keeping them in contact, was accomplished by the common and unpatentable device of substantially fastening them in a compact package, which would not be infringed by such a structure as that in use by the defendant, where the stiff, inflexible elements are bolted through hubs with an insulated bolt of metal.

These differences comprise substantially the issues of this case, and certain patents previously obtained have been cited and put in evidence by the defendant to indicate lack of invention with regard to the various points mentioned. It will be seen from an examination of these patents that Mr. Wightman was apparently the first person to make use of a pile or series of compact resistance sheets, for the specific purpose of a rheostat, to be employed in connection with electric motors, as distinguished from electric circuits in use for different purposes.

The defendant has introduced an article from the *Telegraphic Journal and Electrical Review*, printed in London in 1879, which describes a device of one Muirhead, tried first upon land telegraph lines, prior to 1875, in which year it was applied to the Marseilles-Bona Cable, and between that date and 1879 to the Transatlantic Cable, and in which a great number of sheets of tin foil, slotted to increase the length of the path, were piled together in such a quantity as to balance the resistance of the actual cable, and to form a noninductive resistance equal to the resistance of the cable itself. By this device the duplex system of telegraphy was made possible upon submarine cables, and the principle of an increased resistance, by causing a current to pass successively through a large number of elongated metallic paths or strips in electrical contact, was certainly devised. The Muirhead apparatus was again described in the *Encyclopedia Britannica*, published in New York by Charles Scribner's Sons, in the edition of 1888, and this device would seem to be an anticipation of the Wightman scheme of resistance, unless Wightman can claim invention and originality through the application of the same idea to accomplish a dif-

ferent purpose, even if the electrical phenomena be substantially the same.

It must be observed that the use of electricity as a motive power for railway cars was substantially undeveloped until some time after the use of the Muirhead condenser. Mr. Muirhead was constructing a device for a substantially different purpose, and it would seem that the application of the principle of an elongated path, by means of successive plates, the length of each plate being increased by parallel slots, extending nearly through the plate alternately from opposite sides, might have been suggested from the construction of a condenser in a similar manner; but the two ideas are not of such an identical nature, nor would the purpose and use of a condenser be sufficiently similar to the construction of a device to transform electrical energy into heat that it can be said that Wightman did not construct a resistance upon original lines, and did not make use of invention in the ideas set forth by his patent. It is true that rheostats were known and their need and use understood in the operation of electric cars, and it was for this very purpose that Mr. Wightman conducted his experiments. But the putting together of the idea of some form of resistance with the idea of an elongated insulated path, such as, perhaps, had already proven practicable in the construction of an electric condenser, equivalent in its resistance to a submarine cable, seems to the court to have sufficient elements of originality to justify patentability.

The defendant has referred to the Stockwell patent, No. 326,603, dated September 22, 1885, in which a number of resistance bars, such as carbon, were joined together by conductors to furnish a uniform resistance in connection with electric motors, lamps, and other appliances, and also to the Ries patent, No. 381,815, dated April 24, 1888, the Ries patent, No. 381,816, dated April 24, 1888, and the Simpson patent, No. 25,532, dated September 20, 1859, all relating to the use of electrical resistances, in the form of various wire coils, and for the furnishing of heat (the Ries patent of 1888, No. 381,816 being specifically for the heating of railway cars), and to the Van Depoele patent, No. 394,035, dated December 4, 1888, which made use of the principle of a series of artificial resistances in the form of wire coils (described to be an improvement in electric motors "especially in motors designed for the propulsion of vehicles"), and Mr. Van Depoele was plainly experimenting and inventing a device for accomplishing the ends attained by the rheostat, in the sense in which the term has been used herein.

But it would seem that the idea and purpose of a rheostat was not novel at the time of the Wightman patent, nor was the wire coil an experiment in the line of a compact pile, similar to the application of the Muirhead condenser to the purpose in view. These wire coils could no more be said to anticipate the invention of Wightman than the resistance of Mr. Bentley, patented August 13, 1889, under No. 409,135, in which Bentley, the complainant's expert in this case, described an artificial resistance made up of a series of plates in contact "and provided with a moving arm for cutting more or less of the

plates out of circuit to vary the resistance at will." This Bentley invention has been referred to before in connection with Mr. Bentley's testimony, and the Wightman idea was substantially to substitute for each of Mr. Bentley's contact plates a compact series or pile, much more effective and convenient in form, as well as thereby reducing the number of resistance elements necessary. It would seem, therefore, that Wightman conceived an idea, which in its application to use for the purposes of a rheostat should be declared entitled to the merits of originality, practicability, and convenience, and properly given the protection of a patent at the time the letters patent were issued to him.

The next question to determine is whether the ideas of the Lundie patent, and the construction used by the defendant, are an infringement of Wightman. But before taking up this question it will probably save labor to consider for a moment the Short patent and the Case patent, even if the latter was anticipated by the use of the Sprague grid and the Crocker-Wheeler resistance. The general ideas of the Short patent and the points in which Mr. Short claimed an invention with relation to a resistance series of the Wightman type have been referred to. It is contended by the complainant, as has been mentioned, that the stringing of the resistance plates on the nonconducting pencils and the clamping of the plates, together with the pencils, between heads or end plates, as a means of getting rid of the trough used by Wightman, shows invention in conceiving an idea which should be looked at as a whole, and not viewed as a combination of (1) a plan to create flues in the plates by causing the perforations to register by the use of the nonconducting pencils, and (2) the fastening of the plates in a frame or box by means of bolts.

It would seem that Short's idea of providing flues through the plates, by causing the perforated plates to register by means of pencils of nonconducting material, was original. Further, the insertion of good conductors of heat was an application of the idea of radiation in a manner not apparently tried before. But all forms of resistance, as well as all structures used as rheostats, had been fastened in place and made available by means of some frame and bolt construction. The mere placing of plates in a box, and of attaching the box, whether open or closed (so far as the ends and sides were concerned) to the trolley car by means of bolts, or of bolting together the ends of the box, would seem to be an ordinary mechanical device, and not to contain such elements of originality as to be deemed worthy of being treated as an invention. The purpose of Short was to secure the radiation of heat by taking away the sides of the Wightman trough, and to allow passage of the air through the flues or ducts for the same purpose. The scheme of obtaining rigidity by passing the clamping bolts through the structure—that is, through each plate—and of insulating these bolts, is an independent idea, and a number of patents offered in evidence by the defense to show anticipation must be considered on this point.

The idea of radiation or open-air spaces between the elements was present in the Sprague grid, in the Crocker-Wheeler resistance sections, and in a number of patents, some of which have been already referred to, in which coils of wire attached at each end of the coil

form the elements. Additional patents of this sort are those of E. W. Siemens, No. 324,176, August 11, 1885, the European Siemens-Halske patent, No. 2,251, November 10, 1899, and the McLaughlin patent, No. 432,205, July 15, 1890. Subsequent to the issuance of the Short patent, also, a number of patents were obtained involving the development of the open-air style of resistance, such as the McNulta rheostat, No. 516,217, March 13, 1894, the Davis rheostat, No. 548,867, October 29, 1895, and the Berresford patent, No. 648,481, May 1, 1900; while the Shelton patent, No. 530,727, December 11, 1894, embodied the idea of a separate resistance element, consisting of coils of wire bolted between nonconducting discs or plates of some material such as fireclay.

It is claimed by the defendant that these patents, including the use by Short, are but a development of the old coiled wire idea, and that the principle of air spaces between the elements of resistance is therefore not new in the Short patent. In addition, it is claimed by the defendant that the use, by Lundie, by Berresford, and by Case, of rigid grids, with air spaces between the grids themselves, and the various convolutions or rods of the grids, is as well but a substitution of a different substance or form of grid, to overcome the disadvantages of flexible and movable wires, and that these last patents make use of the old air-space idea, which use was not prevented by anything contained in the Short patent. With this contention of the defendant the court is inclined to agree, and, so far as patentable novelty is concerned, the Short patent must be limited to the manner of construction and to the idea of registering the flues or perforations, rather than to an invention covering and controlling any adaptation of the principle of open-air cooling of the resistance elements.

It does not seem to be contended that the Lundie patent, nor the device used by the defendant, interfere with Short's idea of nonconducting pencils, except as the bolts or clamps of the defendant's device might be called pencils of nonconducting material because insulated. But insulation is an old idea. Wherever bolts come in contact with another conducting element, insulation must necessarily be used, and the precise manner of application would seem to be a mechanical device rather than an invention. Further, the insertion of bolts and clamps, if not purely mechanical, seems to have been anticipated, so far as the Short invention is concerned, in the construction of armatures and dynamos, as early as the Van Depoele patent, No. 394,035, December 4, 1888, the Belding armature, No. 415,697, November 26, 1889, the Belding armature, No. 433,391, July 29, 1890, as well as in the patents for electrical heaters above referred to; and this same principle has been made use of in the other patents between the date of the Short patent and the construction made use of by the defendant, which have been specified above.

The Davis patent, No. 548,867, dated October 29, 1895, shows a supporting rod passing through the center of the elements, with a thread at each end for purposes of clamping, and this patent specifies that:

"Where the central supporting rod is made of conducting material, any well-known means may be employed for insulating the resistance disks therefrom."

This idea of Davis would seem to be correct in treating the principle of insulation as well known and not patentable by Short at the time of securing his patent, and the defendant's device, therefore, would not seem to infringe claims 4 and 5 of the Short patent above referred to.

To return to the Wightman patent, the only remaining question is whether the device of the defendant as developed through the Berresford and Lundie patents, and in the Sprague and Crocker-Wheeler use of grids, is an infringement of the idea which in the Wightman patent has been considered by this court to be invention, namely, formation of a pile or series for the purposes of use as a rheostat, in which the large amount of resistance is obtained by the elongated path furnished by the many elements successively connected in the formation of the pile. The original idea of Mr. Bentley, of forming resistance by sending a current through iron plates, oxidized upon their lateral surfaces, is much similar to the idea in the Davis patent above referred to, and the substitution of cast iron or wrought iron for wrought-iron sheets was, as has been said, a development subsequent to the time of the Short patent. It would seem to the court that an examination of the condition of the art at the time of the Wightman patent, taking into account the use of wire prior to that time (wire necessarily being malleable iron and not cast iron), and a consideration of the details of the Wightman patent, leads to the irresistible conclusion that Mr. Wightman could not have had in mind the use of cast iron as one of the ideas which he was trying to protect by his patent.

It is true that Wightman merely specifies iron and conducting material, and cast iron would be included within the term "conducting material," if the scope of the claims and the condition of the art showed any idea of an intention to cover its use; but it would seem that Wightman was basing his claims to a patentable invention upon the form and use of many "sheets" in one pile, rather than upon the use of a conducting material or of any particular conducting material. The defendant's device would seem to the court to be, therefore, a rheostat in the form of a series or pile, not infringing upon the Wightman patent in any way, unless it be held that Wightman's invention was so broad as to cover the use of any material in any form wherein advantage is taken of an elongated path and a large number of elements. But this was present in the coiled wire resistance boxes, and in the electric heating apparatus of Simpson and Ries, above referred to, as well as in the Stockwell switch, No. 326,603, September 22, 1885, and the Van Depoele motor, No. 394,035, December 4, 1888, and it must be held that Wightman's invention, while making use of similar principles, did not prevent the adaptation of those principles in a different manner, in the form eventually adopted by Berresford, Lundie, and the defendant corporation. The structures or devices which the complainant has placed upon the market, showing a closely clamped and packed rheostat, of flat resistance strips, and the so-called ribbon rheostat of the Westinghouse Company, also made use of by one of the complainants, show the development of the Wight-

man idea, and the use of the same principle of an elongated path and of successive resistances, but in other respects only emphasize the difference between the Wightman invention and the ideas of Berresford, Lundie, and the defendant.

Subsequent to the original argument of the case further testimony was taken with reference to an alleged use by Mr. Sprague, in Richmond, Va., in the years 1887 and 1888, and at Jamaica, L. I., and other places, in the year 1888, and a blue-print marked "1-103," of the resistance used by Mr. Sprague, has been offered in evidence. The use of this resistance for the purpose of a rheostat depends upon the testimony of one Patrick O'Shaughnessy, and the accuracy of his recollection is called in question by a number of affidavits submitted on behalf of the complainant. The testimony of Mr. O'Shaughnessy is hardly definite and persuasive enough to add anything to the defendant's case, and therefore the use by Sprague of any device such as is set forth in the blue-print 1-103 has not been taken into consideration in this matter.

But, without this, it is considered that the contention of the defendant, so far as infringement is concerned, has been supported, and in each case a decree may be entered dismissing the bill.

UNITED STATES v. CASTERLIN et al.

(Circuit Court, N. D. California. June 26, 1908.)

No. 13,915.

1. ADVERSE POSSESSION (§ 70*)—COLOR OF TITLE.

To constitute color of title, the title claimed must be founded on some written instrument, and a mere occupancy of public land by an Indian by permission of the government does not give him color of title thereto.

[Ed. Note.—For other cases, see Adverse Possession, Cent. Dig. § 398; Dec. Dig. § 70.*]

2. PUBLIC LANDS (§ 120*)—SUIT TO CANCEL PATENT—FRAUD.

An applicant for the purchase of an isolated tract of public land under Act Feb. 26, 1895, c. 133, 28 Stat. 627 (U. S. Comp. St. 1901, p. 1519), on a form prepared by the land department, who, pursuant to the requirement of such form and the regulations of the department, made affidavit that the land was not occupied by any one having color of title thereto, is not chargeable with fraud, which authorizes a cancellation of the patent, because a portion of the land was at the time occupied by an Indian, who did not have color of title, or because of a failure to state the fact of such occupancy, in the absence of an actual fraudulent intent, notwithstanding a rule of the department to refuse all applications for the purchase of land so occupied; there being no presumption that the applicant had knowledge of such rule.

[Ed. Note.—For other cases, see Public Lands, Dec. Dig. § 120.*]

3. ADVERSE POSSESSION (§ 70*)—"COLOR OF TITLE."

"Color of title" is a technical term, and means that which in appearance is title, but in fact is not a good title.

[Ed. Note.—For other cases, see Adverse Possession, Cent. Dig. § 395; Dec. Dig. § 70.*]

For other definitions, see Words and Phrases, vol. 2, pp. 1264-1273; vol. 8, p. 7606.]

*For other cases see same topic & § NUMBER in Dec. & Am. Digs. 1907 to date, & Rep'r Indexes

In Equity.

George Clark, Asst. U. S. Atty.

J. H. G. Weaver and W. F. Clyborne, for defendants.

DE HAVEN, District Judge. This is an action brought by the United States to obtain a decree canceling a patent issued to the defendant Mary A. Casterlin for 40 acres of land, part of section 26, township 2 S., range 5 E., Humboldt meridian. The land was purchased from the government by the defendant Casterlin as an isolated tract of land, under Act Feb. 26, 1895, c. 133, 28 Stat. 627 (U. S. Comp. St. 1901, p. 1519), which provides:

"It shall be lawful for the Commissioner of the General Land Office to order into market and sell for no less than one dollar and twenty-five cents per acre any isolated or disconnected tract or parcel of the public domain less than one-quarter section which in his judgment it would be proper to expose to sale after at least thirty days' notice by the land officers of the district in which such lands may be situated: Provided, that the land shall not become so isolated or disconnected until the same has been subject to homestead entry for a period of three years after the surrounding land has been entered, filed upon, or sold by the government."

The application to purchase was made by the defendant Casterlin on April 30, 1900, and the patent issued August 8, 1901. At the time of the filing of the application to purchase the rules and regulations of the Department of the Interior required the applicant—

"to furnish an affidavit, made by himself and duly corroborated by two witnesses, setting forth the character of the land, stating whether it is covered with timber or contains stone or any minerals, whether it is agricultural in character, for what purpose the land would be chiefly valuable, and why he desires the same ordered into the market. It must also be shown that the tract is unoccupied by any one having color of title thereto."

The defendant Casterlin's application to purchase complied in form with this regulation of the Department of the Interior, and stated, among other things, that the tract of land sought to be purchased was not "occupied by any one having color of title thereto." The bill alleges that this statement was false in fact, and was made by the defendant Casterlin for the purpose of deceiving the complainant, and that the complainant was deceived thereby, and issued its patent to the land applied for, and that the falsity of said statement was not ascertained until after the issuance of the patent. The bill further alleges that at the time the application to purchase was made the said land was in occupation and possession of an Indian known as "Indian Jimmie"; that he had been living on the land for a number of years with his family; that he had a house and other improvements thereon, and had cultivated a small portion thereof for garden purposes, for a number of years; and that—

"the defendant Casterlin did, for the purpose of misleading and deceiving the complainant, willfully and intentionally conceal from the said complainant the fact of said occupancy, and said affidavit was false and fraudulent."

The defendant Lyons purchased the land from his codefendant on January 31, 1901.

The bill of complaint alleges that he made such purchase with full knowledge of the fact that the land had been entered under a false statement and affidavit made by his grantor. The defendants filed separate answers, denying all the material allegations of the bill.

There is a decided conflict in the evidence as to whether the house in which "Indian Jimmie" lived at the date of the filing of defendant Casterlin's application to purchase was upon the land in controversy; but my conclusion is that the preponderance of evidence is to the effect that it was not, but was standing a few feet distant, upon an adjoining quarter quarter section. But all of the witnesses agreed that a log cabin used by the Indian as a barn, and a small chicken house, also a cultivated garden containing about one-fourth of an acre and a small field of about 1½ acres, were upon the land in dispute, and in the possession of "Jimmie." I think this constituted such an occupancy of the land on the part of the Indian as would have prevented its sale by the government if the fact had been brought to the attention of the officers of the land department; it being the rule of that department, as promulgated by a circular dated May 31, 1884—

"to peremptorily refuse all entries and filings attempted to be made by others than the Indian occupants upon land in the possession of Indians who have made improvements of any value whatever thereon." 6 Land Dec. Dep. Int. 341.

The question, then, to be determined, is whether there was any fraudulent misrepresentation or concealment upon the part of the defendant Casterlin in making her application to purchase said land. The application, as has been said, was in the form prescribed by the rules and regulations of the land department, and if the statement therein contained, to the effect that the land was not occupied by any one having color of title thereto, is true, there was no false statement of any matter in relation to which the government sought information. The contention of the government is that this statement was false in fact, and that "Indian Jimmie" was an occupant under color of title.

I am unable to agree with this contention. The phrase "color of title" is a technical term, and is defined as that which in appearance is title, but in fact is not a good title. *Wright v. Mattison*, 18 How. 56, 15 L. Ed. 280; *Packard v. Moss*, 68 Cal. 126, 8 Pac. 812. In *Bouvier's Law Dictionary*, it is defined as:

"An apparent title founded upon a written instrument, such as a deed, levy of execution, decree of court, or the like."

In *Lindt v. Uihlein*, 116 Iowa, 48, 89 N. W. 215, the court, speaking of what constitutes "color of title," said:

"It involves, also, the idea of some deed of conveyance, or some paper or document, upon which the holder may reasonably rely as vesting in him the real ownership of the land."

And the Supreme Court, in *Deffeback v. Hawke*, 115 U. S. 407, 6 Sup. Ct. 102, 29 L. Ed. 423, said:

"There can be no color of title in an occupant who does not hold under any instrument, proceeding, or law purporting to transfer to him the title or to give to him the right of possession."

The fact that in this case "Indian Jimmie" was in occupation of a portion of the tract applied for, with the permission of the government, did not give him color of title to the land, as that phrase is defined in the above-cited cases; and it cannot, therefore, be said that the statement contained in the application, to the effect that there was no occupant of said land having color of title thereto, was false.

But it is further urged that in any event there was a fraudulent concealment on the part of the defendant Casterlin in not disclosing the fact of the Indian's occupancy. It is sufficient to say in answer to this contention that there is nothing in the evidence which would warrant the court in finding that the omission to state the fact of such occupancy was intended to mislead the officers of the land department, or to conceal from them any fact which the applicant believed she was required to make known in order for the officers of the land department to exercise a proper judgment in passing upon her application to purchase, and without such fraudulent intent the omission to state the fact was not a fraudulent concealment. There is no presumption of law that the defendant was familiar with the practice of the department to refuse to permit the entry of public lands in the occupancy of an Indian. On the contrary, in the absence of evidence tending to show that she knew that the statement of such fact was material, she was warranted in believing that she was not required to furnish information in relation to any fact not called for by the rules and regulations of the land department, brought to her attention at the time.

It may be proper to add that since the application to purchase this land was made by the defendant Casterlin, the Department of the Interior has so amended its rules in relation to the purchase of lands of this character as to require the applicant to state whether the land applied for is in fact occupied, and, if so, to state the nature of such occupancy, "so that the department can determine whether the occupancy is such that should require withholding the land from sale," and so long as the rules thus amended remain in force a question like that presented in the present case is not likely to again arise.

In my opinion, the government has failed to sustain the allegations of the bill, and judgment must therefore be entered dismissing the action.

In re SCHULMAN & GOLDSTEIN

(District Court, S. D. New York. October 7, 1908.)

BANKRUPTCY (§ 28*) — FAILURE OF BANKRUPT TO FILE SCHEDULES — PUNISHMENT FOR CONTEMPT.

An involuntary bankrupt is subject to punishment for contempt of court for a failure to file his schedules within 10 days after the adjudication, as required by Bankr. Act July 1, 1898, c. 541, § 7, 30 Stat. 548 (U. S. Comp. St. 1901, p. 3424), and by the order of adjudication.

[Ed. Note.—For other cases, see Bankruptcy, Dec. Dig. § 28.*]

*For other cases see same topic & § NUMBER in Dec. & Am. Digs. 1907 to date, & Rep'r Indexes

In Bankruptcy. On motion to punish bankrupts for contempt.

James, Schell & Elkus and H. & J. J. Lesser, for petitioning creditors.

Morris Meyers, for bankrupts.

HOLT, District Judge. This is a motion to punish the bankrupts for contempt for neglect to file their schedules. A petition in involuntary bankruptcy was filed in this case on July 18, 1908. An order of adjudication was entered on August 27, 1908, and duly served upon the bankrupts' attorney, but no schedules have yet been filed.

Section 7 of the bankrupt act (Act July 1, 1898, c. 541, 30 Stat. 548 [U. S. Comp. St. 1901, p. 3424]) requires, and every order of adjudication in involuntary cases contains, a direction that the bankrupt file schedules within 10 days from the date of the order. Until the schedules are filed it is impossible to go on with the proceedings. Many bankrupts pay no attention to their duty to file their schedules, and motions to punish them for contempt for not filing schedules have become very frequent. Hereafter, as a general rule, whenever such motions are made, bankrupts will be fined a sufficient sum to compensate the attorneys for their trouble in making the motion, and, if such fines do not prove sufficient to put a stop to the delay in filing schedules, punishment by imprisonment for contempt will be imposed.

The present motion is granted; but, in view of special circumstances in this case, the bankrupts may purge themselves of their contempt by filing schedules within three days. If the schedules are not filed within that time, they will be fined \$50, and stand committed until the fine is paid.

PYMAN S. S. CO., Ltd., v. MEXICAN CENT. RY. CO., Ltd.

(District Court, S. D. New York. June 25, 1908.)

SHIPPING (§ 178*)—CHARTER PARTY—LIABILITY FOR DEMURRAGE.

Under a charter party providing that lay days for loading should commence at 6 o'clock A. M. the day after the vessel's report of readiness and that she should load in the customary manner at such wharf as she should be ordered by the charterer's agent, the charterer is liable for demurrage for time lost before she could be provided with a berth after such time commenced, although the delay was not due to any fault of the charterer, but to that of a third party.

[Ed. Note.—For other cases, see Shipping, Cent. Dig. § 585; Dec. Dig. § 178.*]

Demurrage, see notes to Harrison v. Smith, 14 C. C. A. 657; Randall v. Sprague, 21 C. C. A. 337; Hagerman v. Norton, 46 C. C. A. 4.]

In Admiralty. Suit for demurrage.

Convers & Kirlin, for libelant.

Frederick R. Swift and Joseph H. Choate, Jr., for respondent.

ADAMS, District Judge. This action was brought by the Pyman Steamship Company, Limited, to recover from the Mexican Central

*For other cases see same topic & § NUMBER in Dec. & Am. Digs. 1907 to date, & Rep'r Indexes

Railway, Limited, demurrage on the British steamer Dunholme, which, it is alleged, became due by reason of her detention in Philadelphia, from 6 A. M. December 24, 1906, to noon of January 4, 1907, in all 11 days and 6 hours at the charter rate of \$213.30, amounting to \$2,399.63. The respondent defended this claim on the ground that under the contract and circumstances prevailing in Philadelphia, no demurrage became due.

The contract provided:

"* * * that the said steamer * * * shall * * * proceed to the port of Philadelphia and after discharge of her inward cargo, there load in the customary manner, from the Agents of the Freighters, at such Dock or Wharf as she may be ordered to by Charterers' Agents on arrival, a full and complete cargo consisting of about 5,000 tons of coal. * * *

It is agreed that the days for loading and discharging shall be as follows, commencing at 6 o'clock A. M. on the day after vessel reports and is ready to receive or discharge cargo:—Cargo to be loaded at customary despatch. * * * Demurrage if incurred to be paid by the charterers or their agents at the rate of ten cents United States currency per net registered ton per day except in case of strike, or any other accidents or causes beyond the control of the charterers which may prevent or delay the loading and/or discharging."

It appears that the Dunholme arrived at Philadelphia December 11, 1906, and discharged her inward cargo at the Richmond Piers. She completed her discharge of such cargo on December 16th and at 7 A. M. of the 17th moved out in the river abreast of the wharf where she had discharged. The holds were at the time cleaned up, the hatches were off and the vessel was in a condition to receive cargo. At 11 o'clock A. M. the same day, the captain gave written notice to the charterer's agent in Philadelphia that his vessel was already to receive cargo. The notice in addition to the tender of the vessel pointed out that the lay days would begin December 18th. On December 26th, the master again wrote to the charterer's agent, referring to the letter of the 18th and calling attention to the fact that lay days would expire at 6 A. M. of December 24th, and that the vessel was then two days on demurrage. The charterer's agent acknowledged receipt of this letter and stated that as soon as an available berth presented itself he would notify the vessel's agent.

Although the steamer was always ready to receive cargo under the charter party after the 17th, the respondent did not order her to a loading berth until 3 P. M. on December 31st. During the intervening time, she had been lying abreast of the wharf where she had discharged.

When the vessel received orders it was to proceed to a berth at the Greenwich Piers, but she was detained at her place of anchorage until the next day, when she was towed to the designated loading berth at the Greenwich Piers, 3 or 4 miles from Port Richmond, the place indicated by the charterer. She completed her loading there at noon January 4, 1907.

It is agreed that 1,000 tons per day is the customary rate for loading coal at Philadelphia and 5 days were properly used in loading. The libellant claims that by the terms of the contract lay days began at 6 A.

M. December 18, 1906, and that the charterer is liable for the time between 6 A. M. of December 24, 1906, and noon of January 4, 1907.

The respondent claims that the lay days did not begin to run until the steamer was at the berth to which she was ordered and that, therefore, no demurrage is due.

It further appears that while the vessel was waiting for orders, the master called upon the agent of the respondent in this matter, Mr. William J. Grandfield, at his office in Philadelphia, and was informed by him that his vessel was to be loaded by the Keystone Coal and Coke Company at the piers of the Pennsylvania Railroad Company at Greenwich Point and directed him to take his vessel there as soon as a berth could be obtained. In the port of Philadelphia coal as cargo is never loaded in any other way than through chutes, from which coal contained in railroad cars is dumped directly into the holds of vessels. There are only three places in Philadelphia at which coal in cargo quantities can thus be loaded. Those are the piers of the Pennsylvania Railroad at Greenwich Point, those of the Baltimore & Ohio Railroad Company at Jackson Street, and those of the Philadelphia & Reading Company at Port Richmond. Vessels of the size of the Dunholme cannot be loaded at the Baltimore & Ohio piers at Jackson Street and there are but four berths at which she could be loaded and but one at Port Richmond. These various piers were entirely under the control of the railroad companies, which owned them, and no shipper had any power to control the order in which vessels should be admitted to them, nor to procure a berth for any vessel except as the owners of the piers might permit.

Before the steamer finished discharging her inward cargo, Mr. Grandfield communicated with the officer in charge of the Pennsylvania Railroad piers, who had the power to determine the order in which vessels should receive their berths, notifying him that the Dunholme would require a berth on or about the 17th of December. At the same time he communicated with the Keystone Coal and Coke Company which was to furnish the coal, notifying it that the cargo would be required and requested it to do what it could to hurry the procuring of a berth for this steamer. On December 17th, the captain of the steamer, notified Mr. Grandfield that his vessel had completed the discharge of her cargo and Mr. Grandfield immediately applied again to the superintendent of the Pennsylvania piers for a berth and from that time until one was actually procured, he made persistent attempts to accomplish that result. During the same time an officer of the Keystone applied frequently for a berth, stating that the cargo was ready, as it actually was.

In spite, however, of all these efforts, no berth was procured for the steamer until about 3 o'clock of December 31st, when she was notified that a berth was ready for her and she moved into it on the following morning. She was then duly loaded.

The respondent seems to have done all it could to expedite the loading. The cause of the delay was the failure of the Pennsylvania Railroad Company to give the vessel proper despatch. While there was an obligation on the vessel's part to load in the customary manner, that evidently referred to the method of loading by chutes, not to the

time of waiting for a berth. The contract provided that the days for loading should commence at 6 o'clock A. M. on the day after the vessel reported and was ready to receive cargo. This vessel reported on the 17th of December, and was ready for a berth on the following morning. She did not receive a berth for several days because the railroad company's berths were occupied and she, therefore, had to wait. This should not be at the expense of the vessel, but of the charterer under the contract.

There will be a decree for the libellant for \$2,399.63 with interest.

UNITED STATES v. MILLER et al.

SAME v. ROBINSON et al.

(Circuit Court, D. Oregon. September 28, 1908.)

Nos. 3,131, 3,132.

1. COURTS (§ 335*) — FEDERAL COURTS — PRACTICE OF STATE COURTS—ACTION—COMMENCEMENT—SUIT IN EQUITY.

The commencement of a suit in equity in a federal court is not governed by the local statute for the commencement of actions in the state courts, but by the equity practice and procedure.

[Ed. Note.—For other cases, see Courts, Cent. Dig. §§ 902-907½; Dec. Dig. § 335.*]

2. LIMITATION OF ACTIONS (§ 118*) — "COMMENCEMENT OF A SUIT" — PROCEEDINGS CONSTITUTING.

To constitute the "commencement of a suit" in equity in a federal court, which will stop the running of the statute of limitations, there must be the filing of a bill and the due issuance of a writ of subpoena, which must come to the hands of the serving officer with intent that it be served, and there must be a bona fide attempt to serve it, followed, if unsuccessful, by reasonable diligence to procure service through further or additional process.

[Ed. Note.—For other cases, see Limitation of Actions, Cent. Dig. §§ 527, 528; Dec. Dig. § 118.*]

For other definitions, see Words and Phrases, vol. 2, pp. 1281-1286.]

3. LIMITATION OF ACTIONS (§ 119*)—ISSUANCE AND SERVICE OF PROCESS.

At the time of the issuance of the subpoena in a suit in equity in a federal court the defendant was absent from the district, and remained absent for several days, although he had an office and his residence therein. The marshal testified that because of such absence he was unable to serve the subpoena when received, and that during its life he made frequent inquiries by telephone at defendant's office and residence, and was each time informed that he was not at home, and therefore returned the subpoena without service. Something over two months after return day an alias subpoena was issued, which was served. *Held*, that there was a bona fide attempt by the marshal to make the service, and that reasonable diligence was used in that behalf and in the issuance and service of the alias subpoena, so that for the purpose of arresting the running of the statute of limitations the suit was commenced on the date of the filing of the bill.

[Ed. Note.—For other cases, see Limitation of Actions, Cent. Dig. §§ 529-535; Dec. Dig. § 119.*]

In Equity. On plea of statute of limitations.

*For other cases see same topic & § NUMBER in Dec. & Am. Digs. 1907 to date, & Rep'r Indexes

John McCourt, U. S. Atty.
A. H. Tanner, for defendants.

WOLVERTON, District Judge. This suit was instituted to set aside a patent conveying a tract of the public lands, on the grounds of fraud practiced upon the general government, inducing its issuance. The patent bears date May 8, 1901. The bill of complaint was filed March 22d previous. A subpoena was issued on the day of the filing of the bill, and was made returnable May 6, 1907. There being no service, an alias subpoena was issued July 16th, and personal service of the same was had on July 31, 1907. The defendant Kribs has interposed a plea of the statute of limitations in bar of the suit, and the only question now presented for consideration is whether the statute had run prior to the commencement of the suit. The limitation prescribed by the statute relative to suits instituted to vacate and annul patents issued by the government is six years.

Some testimony was offered and admitted at the hearing. On the part of Kribs it was shown that he had an office in the city of Portland, Or., between the date of the filing of the bill and that of the service of the alias subpoena, and that he was regularly about his office during the entire period of such interval of time, with the exception of ten days' or two weeks' absence to San Francisco, Cal., and four days to Spokane, Wash. It appears, further, that he departed for San Francisco about March 20th. Kribs during the time had a residence within the city of Portland, and made that his abode with his family, consisting of his sister-in-law and two children. On the part of the government it was shown that the subpoena came into the hands of the marshal on the day it was issued; that the marshal endeavored to make personal service of the same, but was unable to do so by reason of Kribs' absence from the city; that he subsequently made frequent inquiries at Kribs' office and at the latter's house or residence over the telephone, but was informed that he was not about or within the city; that the marshal was unable to find Kribs within the life of the subpoena, and so returned the same, stating the fact that Kribs could not be found, and that service could not, therefore, be made upon him. There was no effort to make substituted service at the place of residence.

It is suggested that the commencement of a suit in equity in the federal court is governed by the local statute for the commencement of actions within the state court; but such is not the rule. The solution of the question when a suit is begun is to be sought wholly within equity practice and procedure. Within the decision of the case of *United States v. American Lumber Co.*, 85 Fed. 827, 29 C. C. A. 431, there must, of course, be the filing of a bill, which must be followed by the suing out of process, or, in other words, the due issuance of the writ of subpoena, which must come to the hands of the serving officer with intent that it shall be served. When these things are done, the suit is commenced. Even then, however, the process will not avail to stay the running of the statute of limitations unless the delivery of the writ of subpoena "be followed either by a service of

the same or by a bona fide effort to serve it." Yet even a bona fide effort will not avail, unless it also is followed by timely proceedings, or, as I take it, by reasonable diligence in procuring service, either personal or substituted. See *United States v. American Lumber Co.*, supra. From this statement in negative form, the positive rule is deducible that to stay the statute there must be a bona fide attempt to serve the writ of subpoena after it has come into the hands of the serving officer, which, if unsuccessful, must be followed by timely proceedings or reasonable diligence to procure service through further or additional process. Does the government bring itself within this rule?

Kribs was out of the district when the subpoena was delivered to the marshal for service, and remained out, concededly, for ten days or two weeks; and, from the statement of the marshal, he could not be found about his office, or his whereabouts ascertained, for a much longer time—indeed, throughout the entire life of the subpoena. That the marshal used the telephone to ascertain whether Kribs was at his office or place of residence, or to obtain knowledge of his whereabouts, rather than going in person to make direct inquiry by word of mouth, cannot be assigned as a lack of diligence. The telephone is one of the most available and speedy means of acquiring information at the present time. If the effort failed of its purpose in the present case, it must have been because of misinformation given out in answer to the inquiries made, and therefore Kribs should be the last person to complain.

But, recurring to the dry question whether there was a bona fide attempt to serve the subpoena, it must be resolved in the affirmative. It is true that no attempt was made to make substituted service at Kribs' residence; but a bona fide attempt to serve does not require that every source by which service might be accomplished should have been exhausted. It is sufficient if the officer in good faith, or with a real purpose to serve, made reasonable effort to accomplish his purpose. The evidence shows to my mind that he did this. There was some delay in making the return and issuing the alias subpoenas, but not unreasonable or unwarranted. There was manifestly a direct and continuing purpose all the while to accomplish the service, and the diligence displayed looking to that end must be considered to have been reasonable diligence.

The plea, therefore, that the suit is barred by the statute of limitations, should be held to be insufficient, and it is so considered.

THE POTTSVILLE.

(District Court, S. D. New York. June 11, 1908.)

TOWAGE (§ 15*)—LOSS OF TOW—LIABILITY OF TUG.

Evidence considered, and *held* not to sustain the allegation of a libel that the sinking of a coal barge while in tow on a hawser was due to the fault of the tug in towing her on a rock, but to show that it was the result of tempestuous weather which caused a collision between such barge and another tow.

[Ed. Note.—For other cases, see *Towage*, Cent. Dig. § 36; Dec. Dig. § 15.*]

In Admiralty. Suit against tug for loss of tow.

Wilcox & Green, for libellant.

Kneeland & Harrison, for claimant.

ADAMS, District Judge. This action was brought by James H. Cullen, the owner of the barge *Edward F. Cullen* and the bailee of cargo of coal laden on board, to recover from the tug *Pottsville*, the damages sustained by reason of the sinking of the barge and cargo on the 12th day of November, 1906, while being towed on a hawser from New York harbor to New Haven, Connecticut. The accident happened off Shippan Point, near Stamford, and the libellant claims that his boat was towed on a well-known rock. The claimant contends that the boat following the *Cullen* was forced by the inclement weather to strike the stern of the latter, causing her to fill and become swamped.

The libellant's contention is that the tug was towing entirely out of a proper course so that the boat was dragged over a rock inside of the light, while the claimant contends that the tow was pursuing a proper and usual course, a half or three-quarters of a mile to the southward of the light on said point.

The libellant's contention is sustained solely by the testimony of the master of the boat on board. His testimony, however, is very seriously discredited and the claimant's sustained by the fact that shortly after the accident he made an affidavit as follows:

"New York, Nov. 15, 1906.

This is to certify that I, Captain N. B. Cahoon of the boat '*Edward D. Cullen*' left Brooklyn, about 1:30 P. M. on the 12th inst. in tow of Tug '*Pottsville*' my boat being port hauser boat, bound for New Haven with 650 tons of Chestnut coal. Boat *Leslie R.* was starboard hauser boat and boat '*McCusker & Shroeder*' towing under my stern. We passed Execution Light about 7 P. M. wind North, Northwest and when about abreast of Long Neck Point, the wind shifted West, Southwest and blew hard, causing a heavy sea to run. Boat *McCusker & Shroeder* hit my stern in the sea and caused my boat to sink about 11:30 P. M. off Ship Ann Buoy. [Signed] N. B. Cahoon.

Sworn to before me this 15th day of November, 1906.

[Seal.] William A. Evans, Notary Public, New York County."

The claimant produced several witnesses from the tug and tow who testified that the accident happened as alleged by the answer. The account is shown to be correct by the fact that the tug, which drew nearly a foot more than the *Cullen*, suffered no injury, which must

*For other cases see same topic & § NUMBER in Dec. & Am. Digs. 1907 to date, & Rep'r Indexes

have happened if the libellant's theory of the accident is correct. I find no corroboration of the libellant's account in the wounds received by the boat on the bottom. She was raised by pontoons after the sinking and was doubtless injured thereby and by being sunk on the rocks. The libel is dismissed.

In re WOLF CO.

(District Court, M. D. Pennsylvania. September 29, 1908.)

No. 976, in Bankruptcy.

1. BANKRUPTCY (§ 58*)—VOIDABLE PREFERENCE—KNOWLEDGE OF CREDITOR.

A creditor of a bankrupt, who at the time of receiving a preference was put on inquiry as to the solvency of the debtor, was not for that reason charged with notice of facts which could only be learned from intimate and inaccessible sources of information, such as the books of the bankrupt, but was bound only by such information as could be obtained by open observation and reasonable inquiry.

[Ed. Note.—For other cases, see Bankruptcy, Dec. Dig. § 58.*]

2. BANKRUPTCY (§ 58*).

A creditor of a bankrupt corporation, who at the time he received a preferential transfer of property as security knew that the corporation was financially embarrassed and was pressing for payment, held not to have had reasonable cause to believe it insolvent, so as to render the preference voidable, although such was the fact where he made inquiry as to its condition from its officers and others who were in the best position to know, and was assured that the value of its property exceeded its debts and that its embarrassment was only temporary.

[Ed. Note.—For other cases, see Bankruptcy, Dec. Dig. § 58.*]

In Bankruptcy. Sur exceptions to report of Samuel F. Huber, special master, dismissing petition of J. B. Allender for rule on receiver to withdraw notice of claim.

The following is the report of the master:

Findings of Fact.

First. J. S. Allender, the petitioner, loaned to the Wolf Company \$8,000 on a promissory note, and on the 12th of January, 1907, obtained an assignment by the Wolf Company to him as collateral of a claim of \$14,596.33 which the Wolf Company had against the Pacific Export Lumber Company, of Portland, Or. On the 8th of April, 1907, the Wolf Company was adjudicated an involuntary bankrupt, and the same day your honorable court appointed Walter K. Sharpe, Esq., receiver, who as receiver notified the Pacific Export Lumber Company not to pay the money due on the claim to J. S. Allender, the petitioner, but to pay the same to him as receiver. The Pacific Export Lumber Company then refused to pay the same to J. S. Allender, and J. S. Allender petitioned your honorable court to decree that Walter K. Sharpe, receiver, withdraw his claim to the fund, and that the same be paid to J. S. Allender, the petitioner, and on account of which petition the matter was referred to Samuel F. Huber, as special master, and to which petition the receiver filed his answer denying the petitioner's right to said fund, and a supplementary answer, praying the court to adjudge and decree the said assignment null and void, and that the same be set aside, and the receiver of the Wolf Company, or any trustee of said company, be directed to collect the said claim from the Pacific Export Lumber Company. The master sat six days, and took the testimony, and makes report thereon.

Second. The Wolf Company, a manufacturer of flour mill machinery, is a Pennsylvania corporation chartered in 1902, and has its principal place of

*For other cases see same topic & § NUMBER in Dec. & Am. Digs. 1907 to date, & Rep'r Indexes

business in Chambersburg, Pa. On the 8th of April, 1907, upon a petition filed by certain creditors, the Wolf Company, admitting the facts in the petition, was adjudicated an involuntary bankrupt, and the same day Walter K. Sharpe, Esq., of Chambersburg, Pa., was appointed receiver, who as receiver continued to operate the business of the company. On the 12th day of January, 1907, there was assigned to J. S. Allender, an unsecured creditor of the company, a certain account which the Wolf Company held against the Pacific Export Lumber Company, of Portland, Or., which then amounted to \$14,596.33, but which was reduced by penalties at various times since that, and is now admitted to be about \$7,500, a copy of which assignment is as follows:

Exhibit D—Transfer Wolf Co. to J. S. Allender.

"Whereas, a certain contract was entered into June 26, 1905, by and between the Wolf Company, of Chambersburg, Pa., of the one part, and the Pacific Export Lumber Company, of Portland, Or., of the second part, wherein party of the first part agreed to furnish to party of the second part certain machinery to be used by the Hong Kong Milling Company, at Hong Kong, China;

"And whereas, the Wolf Company claims there is a balance yet due on this contract, including extras, to the amount of fourteen thousand five hundred and ninety-six and $\frac{33}{100}$ dollars (\$14,596.33);

"And whereas, the Wolf Company is indebted to J. S. Allender on a certain note, a copy of which is as follows:

"The Wolf Company Works, Flour Mill Machinery.

"No. B345.

\$8,000.00

"Chambersburg, Pa., May 1, 1906.

"Six months after date we promise to pay to the order of J. S. Allender, at the office of the Wolf Company, Chambersburg, Pa., eight thousand and no/100 dollars, without defalcation, for value received, with interest at 6 per cent.

The Wolf Company

"Due Nov. 1, 1906.

By H. G. Wolf, President.'

"Now, know all men by these presents, that we, for value received, hereby assign, transfer, and set over to J. S. Allender, as collateral, to be recovered by him to his use, to secure the above-described note, all sum or sums of money now due or to become due to us from the Pacific Export Lumber Company on the contract above referred to, with full authority to sue, recover, collect, and receive the same from the said Pacific Export Lumber Company, as fully as we could do ourselves, and out of the first money collected pay the above-described note and interest in full, together with the costs and expenses of recovering the same, if any, and the balance of the proceeds to be returned to the Wolf Company.

"In witness whereof, the Wolf Company has hereto attached its signature by its president and affixed its corporate seal, duly attested by its treasurer.

"The Wolf Company,

"Attest: I. C. Walk, Treasurer.

By H. G. Wolf, President."

If the plant, assets, and business of the Wolf Company were sold, unsecured creditors would receive from 15 to 20 per cent. on their claims. If J. S. Allender receives the money on the account assigned, he will thus obtain a greater percentage of his debt than any other of the creditors of the Wolf Company of the same class. It does not appear that the assignment was recorded, nor does it appear that recording is required. It was admitted by the petitioner that the Wolf Company was insolvent on the 12th of January, 1907. The same condition continued without any material change to the 8th of April, 1907, the day of the adjudication.

Third. J. S. Allender, the petitioner, a man 55 years of age, has been a resident of the city of Baltimore, Md., for the past 13 years, and has been selling flour mill machinery for 25 years, and has since 1902 been on the road traveling in different parts of the United States selling flour mill machinery for the Wolf Company, with the exception of about a month in each year, and during that period at different times visited at the offices of the

company. His last term of employment was for one year, which contract terminated 1st of January, 1907, but his employment by the Wolf Company for the last two months is disputed. The last year of his employment was spent largely in the Pacific Coast states for the company, during which time he came East to its offices, spending a short time there in February and July. J. S. Allender has been a money lender for the last 15 years, and in 1900 loaned \$1,200 to the Wolf Company, which loan was renewed and amount increased from time to time until it reached the sum of \$8,000, for which he held a note, which note was renewed from time to time for about three years. The last renewal was the 1st of May, 1906, at which time the company gave its note for \$8,000 for six months at 6 per cent.

Fourth. Prior to the last renewal there was some correspondence between H. G. Wolf, president of the Wolf Company, and Mr. Allender, in reference to it. Mr. Allender, the petitioner, desired a 30-day renewal, and Mr. Wolf suggested that, if Mr. Allender desired the note paid, the company would prefer to make four notes of it, payable in 30, 60, and 90 days, and 4 months, as this arrangement was preferred by the company. On the 10th of April, 1906, the said president forwarded to the petitioner a letter in which he inclosed a statement purporting to show the financial condition of the company, which showed that after paying the debts, including the capital stock, the company had a surplus of \$70,434.90. The petitioner agreed by a telegram to renew the note for six months, to which the president of the company wrote as follows: "The writer wants to personally assure you that you need not have any alarm as to the financial standing of the Wolf Company, and if you get any report to the contrary, and will advise us, we shall be only too glad to inform you as to the true facts." In this letter he inclosed a financial statement, showing an increased surplus on April 25, 1906. The petitioner wrote to the president of the company as follows: "Harry, if you and Mr. Walk have a certain knowledge that this is gilt-edge paper, you can renew for six months as before. I note statement inclosed. It has but little effect on me. I rely on yours and Mr. Walk's honor. I borrowed money myself lately to make ends meet, but I am satisfied that a note of \$7,700 will be paid in bank on the same day yours is due. That will help me out. I am getting 7 to 8 per cent. on gilt edge now in some places where money is worth more than it is East. I am going to wire you, as I do not believe this will reach you in time." The petitioner visited the offices of the Wolf Company in July, 1906, at which time he had a conference with Mr. Walk, the treasurer of the company, and among other things Mr. Allender was informed that the company was involved in two lumber propositions, one in Lumber City, Ga., to the extent of \$60,000, and the other in Pikeville, Tenn., to the extent of \$125,000, and that, owing to the large amount of money required to carry the propositions along, the treasurer felt that if they continued to drain the Wolf Company it would make their position before very long very hazardous.

Fifth. The petitioner had left the \$8,000 note with the Grafton Bank & Trust Company, of Grafton, W. Va., and he himself at the time of the maturity of the note was in the state of Oregon. Before its maturity he had written to the company asking for a financial statement, and received no reply, and later notified the company that he would require the payment of the note at maturity, and in a conversation with H. W. Gladhill, another traveling salesman of the company, stated that the company had failed to forward him a requested financial statement, and that he was apprehensive of the status of affairs, and had concluded to collect the note. About the latter part of October the petitioner had a conversation with said H. W. Gladhill, in Portland, Or., who was a salesman and expert miller of the company, being sent there by the company to assist the petitioner in closing a contract, at which time they talked about the petitioner's claim against the company, and the petitioner informed Gladhill that he had advised his banker to collect the note when due, and asked Gladhill's opinion of the company's financial condition. He informed the petitioner that he believed the company had an equity in the business, and that he believed the loan was a safe one. The petitioner for some reason telegraphed his banker not to take any action on the note until he went to Chambersburg, Pa., to investigate. Mr. Gladhill further told him that he believed Mr. Walk had not answered the letter because he was not

in position to give him a favorable answer, and that he probably preferred not to say anything about it. In answer the petitioner stated he would investigate when he came in. The petitioner learned that his note was not paid at maturity, and visited the company's offices, about November 8 or 9, 1906, with reference to the note and an additional loan, if proper security could be obtained. The petitioner had determined, although he had not expressed it to the company, to quit their employment at the expiration of his term, unless arrangements were made to send him to China or to Japan. In his visit he conferred with H. G. Wolf, the president, and I. C. Walk, the treasurer, of the company, and was by them informed that they could not then pay the note, and that if he compelled payment by suit a crash would be precipitated, and he, with other creditors, would lose. He had about this time several conferences with them, and made several trips from Baltimore to Chambersburg, and as the company postponed payment from time to time he placed the collection of his note in the hands of local attorneys, namely, Ruthrauff & Nicklas. The claim was more especially under the care of J. R. Ruthrauff, Esq. On the 16th of November, 1906, the petitioner and the Wolf Company entered into an agreement as follows:

Exhibit A.

"Whereas, the Wolf Company is indebted to J. S. Allender in the sum of eight thousand dollars (\$8,000), represented by a note, a copy of which is as follows:

"The Wolf Company's Works, Flour Mill Machinery. \$8,000.00.
"No. B345.

"Chambersburg, Pa., May 1, 1906.

"Six months after date we promise to pay to the order of J. S. Allender, at the office of the Wolf Company, Chambersburg, Pa., eight thousand and no/100 dollars, without defalcation, for value received, with interest at 6 per cent.

The Wolf Company,

"Due Nov. 1, 1906.

By H. G. Wolf, President.'

"And whereas, the Wolf Company is trying to effect a reorganization, and has requested the said J. S. Allender to accept a note of Aug. Wolf & Co., for eight thousand dollars (\$8,000) in lieu of the note above described:

"Now, it is agreed, this 16th day of November, A. D. 1906, by and between J. S. Allender, of No. 1817 Walbrook Ave., Baltimore, Md., of the first part and the Wolf Company, of Chambersburg, Pa., of the second part, as follows: Said J. S. Allender, in case said reorganization is effected on or before December 1, 1906, agrees to accept the note of Aug. Wolf & Co. for eight thousand dollars (\$8,000), payable twelve months after date, with interest at six per cent. (6%), provided all accrued interest now due is paid on the present note, and eighty (80) shares of the preferred capital stock of the reorganized Wolf Company, representing eight thousand dollars (\$8,000) of the par value thereof, is placed with him as collateral to secure the payment of the note of Aug. Wolf & Co., above mentioned. The present note to be surrendered and new note accepted simultaneously with the delivery of the stock above referred to.

"The Wolf Company, in consideration of the surrender of its note, in case reorganization is effected within the time mentioned, agrees to give to the said J. S. Allender the note of Aug. Wolf & Co., for eight thousand dollars (\$8,000), payable twelve months after date, with interest at six per cent. (6%), secured by eighty (80) shares of the preferred capital stock of the reorganized Wolf Company, representing eight thousand dollars (\$8,000) of the par value thereof; also to pay all accrued interest due on the Wolf Company's note at the time of the exchange of notes is made.

"In witness whereof, the parties have hereunto set their hands and seals.

"J. S. Allender. [Seal.]

"The Wolf Company,

"By H. G. Wolf, President.

"Sixteenth November, 1906. I hereby assign eighty (80) shares of my portion of the preferred capital stock of the reorganized Wolf Company to J. S. Allender, and hereby authorize the treasurer of said company, in case said reorganization is effected within the time mentioned, to deliver the same to

him upon his acceptance of the note of Aug. Wolf & Co., above referred to, to be held by him as collateral to secure the payment of the note of Aug. Wolf & Co., for eight thousand dollars (\$8,000).
H. G. Wolf."

Sixth. At the time of the above-mentioned agreement, and prior thereto, both Mr. Allender and his counsel knew that the Wolf Company required additional capital to operate, in consequence of which arrangements had been made by the company with George H. Stewart et al., known as the "Wolf Company Syndicate," whereby the syndicate agreed to advance \$92,000 upon certain conditions, in this way furnishing to them necessary capital. The condition upon which the money was advanced was known by Mr. Allender, and he also knew that expert auditors and accountants were working on the books of the company at the offices in November and December, 1906, to ascertain the company's condition. Mr. Allender made frequent visits to Chambersburg about every two weeks, at which time he called at the offices of the company and saw the experts at work on the company's books. It does not appear that he inspected the books of the company while at the offices, or that he requested that privilege or was denied it. He conferred on a number of his visits with his counsel, and discussed the situation with the president and treasurer of his agreement, and threatened suit if the company failed to pay it. On the 1st day of December, 1906, the reorganization scheme mentioned in the above agreement having failed to go through, the agreement, after considerable negotiation, was renewed and the time extended for a period of 30 days. About the 10th of November Mr. Allender had discussed with Mr. Wolf, the president of the company, with respect to making an additional loan, increasing it from \$8,000 to \$20,000, provided proper collateral could be furnished, at which time he was informed that, on account of the agreement with the syndicate, it could not be done, the bonds having been placed as collateral with the syndicate, and that the company was then endeavoring to arrange to have its creditors accept Aug. Wolf & Co.'s notes at two months or more in place of the Wolf Company obligations.

Seventh. In one of his visits, in November or December, 1906, to the offices of the company, he met John T. Pensinger, a director and salesman of the company, and discussed with him the condition of the company. He (Allender) said "that he had heard some very bad reports in regard to the financial condition of the Wolf Company, and if the reports were true the chances were for him to lose a lot of money with them." He also told Mr. Pensinger that he had loaned them \$8,000. About the same visit he had a conversation with H. W. Gladhill, a salesman of the company, about his claim against the Wolf Company, and told him he was going to bring suit unless his claim was paid on the 1st of January, and had so instructed his attorney. He spoke further to Gladhill "about the loan, and the manner in which it was made, and the risk that he had taken," and told Gladhill, further, "that he had made the loan largely on his belief that the Wolf Company and Mr. Walk would inform him if there was any danger; that it was a personal matter between them, and it appeared to him that they had in a measure betrayed his trust, and he believed that he would lose his claim." Mr. Gladhill, who had a room in the office of the company, saw Mr. Allender almost every time he visited the offices of the company, and they discussed the matter of the loan and the condition of the company, and the report of the auditors and accountants, which had then become known. The report was intended to be kept a secret, but was generally known by the employes about the offices. Mr. Allender at this time knew of the report of the auditors and of the results of their examinations, and discussed it with Mr. Gladhill, and in discussion tried to solve the reasons for the indebtedness of the company.

Eighth. About the 1st of January, 1907, at the expiration of the extended agreement, Mr. Allender came to the offices of the Wolf Company and in a conference with Mr. Walk, the treasurer, he was informed that the scheme of the syndicate agreement had fallen through, and they discussed the \$92,000 obligation of the syndicate, payable \$10,000 1st of February, \$30,000 1st of March, and the balance of about \$50,000 1st of April. Mr. Allender inquired if the company could meet it, and was told by the treasurer that "it largely depended on Mr. Wolf's efforts to obtain money from some other source," and

the treasurer expressed a doubt as to their ability to raise the money to meet the payments. He was further at that time informed that the company was involved in lumber propositions; that they had \$125,000 in Pikeville, Tenn., and \$60,000 in Lumber City, Ga., and he was fearful that these propositions, to which the Wolf Company had advanced money and taken notes, would be unable to meet them at maturity, and, the said notes having been discounted for the Wolf Company, the Wolf Company might be compelled to meet them when due. In his conversation with the president and treasurer of the company he insisted that his note must be paid or proper security given, and that if the company failed to do it he would bring suit against them. He demanded security, and was told that bonds were not in their possession at that time. He consulted with his counsel in his effort to obtain security, and they called the president to his attorney's office and demanded security, and, failing to obtain it, demanded a judgment note, stating it would not be entered until a future time, and the president, Mr. Wolf, refused to execute such a note for them, and asked for a 10-day extension, stating that he felt he could raise the money. The extension was then granted, and the president left and endeavored to raise the money. About the 10th of January, the expiration of the 10-day extension, Mr. Allender appeared at the offices of the company and asked for Mr. H. G. Wolf, the president, and was informed that he had not returned. Mr. Allender then became very angry, and, speaking of Mr. Wolf, said, "The son of a bitch, the God damned son of a bitch, wants to beat me out of my money," but was told that such was not the case and that they expected Mr. Wolf's return in several days. During the wait for Mr. Wolf's return he discussed the financial condition of the company with Mr. Gladhill and Mr. Walk, and insisted on the payment of his note, and said, unless it was fixed up satisfactorily to him, he would sue the company. On the 12th of January he visited the office of Mr. Wolf, who had then returned, and was informed that the company could not meet the note; that Mr. Wolf was unable to raise the money which he was after. Mr. Allender then again consulted his attorney, and afterwards called Mr. Wolf to the office, and Mr. Ruthrauff, Mr. Allender's counsel, suggested that, instead of bringing suit, the company should give Allender a judgment note as collateral security for his note, but this was refused. He stated that the note would not be entered as a lien against the company's property until the time when judgment might be obtained in case a suit was brought and no defense interposed, viz., the Tuesday following the first Monday of February, but was informed by Mr. Wolf that it would be suicide for the company to do anything of that kind. The matter of other security was taken up, which could be furnished by the company. The Pacific Export Lumber Company's claim was then discussed, and it was finally agreed that it should be transferred to Mr. Allender, copy of which transfer is above set forth, being dated the 12th of January, 1907, marked "Exhibit D."

Ninth. Mr. J. R. Ruthrauff, attorney for Allender, knew at the time of the transfer that the Wolf Company had sent out letters to its creditors in which it asked them for an extension of time to meet their notes and to accept Aug. Wolf & Co.'s paper in settlement of the Wolf Company notes, and thought that it would affect the company's credit, by exciting suspicion as to the company's financial standing, and that this action had caused many creditors to place their claims in the hands of attorneys for collection, and that in addition to the Allender claim he had had other claims for collection against the company, and knew that Charles Walter, a member of the Franklin county bar, had a claim of the Farrel Foundry & Machine Company, of Ansonia, Conn., amounting to about \$20,000, and was informed by Mr. Walter that suit would be brought by him if Mr. Allender brought suit on his claim. Mr. Allender stated that in conference with Mr. Wolf he was informed that the indebtedness of the Wolf Company had practically been reduced to \$30,000, by having creditors accept Aug. Wolf & Co.'s paper; but he received the greater part of his information from the treasurer of the company, who on a number of occasions informed him of its large indebtedness and expressed his doubt as to its ability to meet its obligations when they fell due.

Tenth. The officers of the company suspected the insolvency of the Wolf Company prior to the examination of the expert accountants, who were em-

ployed in November and December to ascertain the company's financial status for the benefit of the proposed Wolf Company Syndicate, but were not positive. The experts' examination revealed to them the company's insolvency; it being the first real knowledge of this on the subject obtained. Mr. Allender, who knew of the examination which was made by the experts, could, so far as the evidence shows, have obtained the result of the examination from the same source from which the officers of the company obtained theirs, had he made proper inquiry.

Eleventh. The transfer executed 12th of January, 1907, marked "Exhibit D," was made by the president and treasurer, without authority of the board of directors of the company. It does not fully appear from the testimony that the act of the president was beyond his authority, but it was testified by the treasurer that when large loans were made they were authorized by the board of directors and stockholders, and from all the testimony submitted the transfer of a book account or claims of the kind assigned to Allender seems to have been without precedent in the history of the company, and there appears to have been no authority of such transfer at any time granted to the president and treasurer.

Conclusions of Law.

First. The effect of the enforcement of the transfer by the Wolf Company to J. S. Allender of the Pacific Export Lumber Company claim would be to enable J. S. Allender to obtain a greater percentage of his debt than any other of the creditors of the Wolf Company of the same class. Both J. S. Allender and his counsel, acting for him in the matter of the collection of his note against the Wolf Company, had reasonable cause to believe that it was intended by said transfer to give to him (J. S. Allender) a preference. The Wolf Company was insolvent when the transfer to J. S. Allender was given, and its condition remained unchanged up to the time of the adjudication. J. S. Allender made repeated threats, if the note was not paid, to bring suit. He conferred frequently with his attorney. He visited the offices and discussed with different parties his fear of losing his money, and was told by the treasurer that he was afraid that the company might not be able to meet its obligations. His conduct indicated that he was exceedingly anxious about the status of his claim. He saw the expert accountants at work on the books of the company, and discussed the result of their report with Mr. Gladhill, and would have been able to learn that status of the company from the same source the company itself obtained its information, had he made the proper investigation.

Second. "Sec. 60a. A person shall be deemed to have given a preference, if, being insolvent, he has within four months before the petition * * * made a transfer of any of his property in favor of any person, or made a transfer of any of his property, and the effect * * * of the transfer will be to enable any one of his creditors to obtain a greater percentage of his debt than any other of such creditors of the same class." Section 60b provides that: "If a bankrupt shall have given a preference, and the person receiving it, or to be benefited thereby, or his agent acting therein, shall have had reasonable cause to believe that it was intended thereby to give a preference, it shall be voidable by the trustee." Act July 1, 1898, c. 541, 30 Stat. 562 (U. S. Comp. St. 1901, p. 3445). From the evidence the referee finds that J. S. Allender was in possession of such facts as would have put a reasonably prudent man upon inquiry, and, if made, would have shown that the bankrupt was insolvent. "Notice of facts which would incite a person of reasonable prudence to an inquiry under similar circumstances is notice of all the facts which a reasonably diligent inquiry would disclose." *Coder v. McPherson*, 18 Am. Bankr. Rep. 523, 152 Fed. 951, 82 C. C. A. 99; *Pittsburgh Plate Glass Co. v. Edwards*, 17 Am. Bankr. Rep. 447, 148 Fed. 377, 78 C. C. A. 191. J. S. Allender knew that the treasurer of the company had stated to him that he was afraid the company would not be able to meet its obligations when they fell due, and Mr. Allender also knew something of the adverse report of the experts whom he had seen examining the books of the company. These facts would inevitably incite the ordinary creditor to inquire further into the condition of the company before making a loan, and such an inquest would have developed

the facts that some of the flattering statements he heard with reference to the company's solvency were not true. The preference is therefore voidable, and the prayer of the petition of J. S. Allender should therefore be refused. The prayer of the petition of the receiver, who is now the trustee, should be granted.

Third. Not only is the preference obtained by Allender voidable under the bankruptcy act, but the transfer to him of the Pacific Export Lumber Company's claim, having been executed and delivered by the president and treasurer of the company, without being authorized or ratified by the board of directors of the company, is not binding upon the company, and the prayer of the petition of J. S. Allender should therefore be refused, and authority granted for the payment by the Pacific Export Lumber Company of the amount due to the proper representative of the court and creditors in the bankruptcy proceedings.

O. C. Bowers and J. R. Ruthrauff, for exceptions.
J. A. Strite, opposed.

ARCHBALD, District Judge. On January 12, 1907, the Wolf Company, of Chambersburg, Pa., the present bankrupts, assigned to J. S. Allender, a creditor, an account against the Pacific Export Lumber Company amounting on its face to \$14,593.33, but on which only \$7,500 was really owing, to secure a promissory note of \$8,000 for money which Allender had loaned to the Wolf Company, which had been due since November 1, 1906, and on which he was pressing for payment. Within three months afterwards, on April 8, 1907, the Wolf Company were put into bankruptcy in this court, and a receiver appointed, who subsequently gave notice to the lumber company not to pay the account to Allender; the transfer being contested on the ground that it was a preference. Payment having been refused, Allender has petitioned the court to order the receiver to withdraw his notice and permit him to get the money. The master, to whom the case was referred, sustained the contention of the receiver and recommended that the petition be dismissed, and the case now comes up on exceptions to his report.

The assignment was clearly a preference—whether voidable or not is another matter—and the court cannot, therefore, be expected to do anything to help it out, if that is what is wanted. *Pollock v. Jones*, 10 Am. Bankr. Rep. 616, 622, 124 Fed. 163, 61 C. C. A. 555. But, rightly considered, that is not the case. The assignment was a complete transfer of the account, vesting title in the creditor, and giving him full authority over it, including the right to sue and collect it, if necessary. The transaction being thus an executed one, there is nothing left to do but to give effect to it, unless it is tainted. The notice from the receiver merely tied up the matter; the lumber company, had suit been brought by the present petitioner, being bound to pay it. The rule taken on the receiver to withdraw his claim may serve to facilitate the collection; but, however decided, it confers nothing on the creditor that he did not have already. And the money, by arrangement between the parties, having now been paid over to the receiver upon the understanding that it was to be disposed of according to the views entertained by the court of the transaction, the petitioner is entitled to it, unless the court is convinced that it amounted to a voidable preference.

The question whether the transfer was a voidable one depends on whether Mr. Allender had reasonable cause to believe that a preference was intended; that is to say, that he was getting a prohibited advantage over other creditors similarly situated. He was if the company was insolvent, but not if it was not; and the case turns, therefore, on whether the signs of insolvency were such as to put him on inquiry, affecting him with whatever it would have discovered. It is not easy to decide, much less to point out in advance, what will amount to notice; each case standing pretty much on its own bottom. Mere financial embarrassment is not always enough, although it usually will be. The law differs somewhat in this respect from what it was formerly, owing to the different meaning given to insolvency, which, under Act March 2, 1867, c. 176, 14 Stat. 517, existed if the debtor was not in a condition to pay his debts in the ordinary course of business (*Toof v. Martin*, 13 Wall. 40, 20 L. Ed. 481), but not now, unless the aggregate of his property is insufficient to meet his obligations.

In the present instance, the Wolf Company was embarrassed, and, as we now know, insolvent; but whether insolvency was so plainly indicated that Mr. Allender could not properly close his eyes to it is a question. There is no doubt that before the last renewal of his note, May 1, 1906, he hesitated about extending it, and when it came due November 1st, he insisted upon payment, although even then he was ready to more than double the loan if it could be properly secured. Meantime, also, in the preceding July, in an interview with Mr. Walk, the treasurer, he was told that the company was indulging in Southern lumber operations the outcome of which was not encouraging, and in October, in a talk with Mr. Gladhill, another salesman, he expressed doubt as to the safety of the loan, stating that he had written to Walk about it, but could get no answer; and on visiting Chambersburg, about November 10th, he was told by Walk that the note had not been paid because the company had no money. But, on the other hand, he was assured by H. G. Wolf, the president, who was supposed to be a personal friend, that his money was safe, and in accordance with a proposed reorganization of the company, which was under consideration by a syndicate who had taken an option on the property, he was offered the obligation of Aug. Wolf & Co., an auxiliary concern, who were to take over the lands of the Wolf Company in different states, as well as certain personal assets, and assume the floating indebtedness. Allender thereupon consulted Mr. Ruthrauff, a prominent attorney of Chambersburg, who in turn went to Sharpe and Elder, who were conducting the matter for the syndicate, and got from them the particulars of the scheme, after which he advised Mr. Allender to accept the note of Aug. Wolf & Co., provided 80 shares of the preferred stock of the reorganized company were put up as collateral, and this arrangement was agreed to; the Wolf Company being given until December 1st to carry it out, which was subsequently extended to January 1st, the reorganization not having been perfected by December 1st, as expected. In the meantime, however, the expert accountants, who were investigating the affairs of the company in the interest of the syndicate, made an unfavorable report, and when Allender came to see about his note, January 1st, he was informed that the contemplated reorganiza-

tion was not going through, at least with these parties. Walk told him that the option had been withdrawn at the request of Mr. Wolf, and that the syndicate had given 90 days in which to repay the \$92,000 which had been advanced—\$10,000 of which was to be taken care of February 1st, \$30,000 more by March 1st, and the balance by May—which he expressed his doubt of the ability of the company to do, depending, as it did, on Mr. Wolf's getting the money from other sources. But Mr. Wolf himself explained that he had called off the deal because he had not been fairly treated in the appraisalment of the property, stating at the same time that the trade debts had been taken care of by Aug. Wolf & Co. down to about \$30,000, including the note of Allender, and that the Wolf Company in consequence was better off financially than it had been for years. He further promised Allender to pay his note within 10 days. Coming again to Chambersburg at the end of that time, Wolf was not on hand to meet him with the promised money. This made him angry, and he accused Wolf to Walk of intending to beat him out of it, threatening to sue the company before the day was over. Walk told him, if he did, it would precipitate matters, and neither he nor other creditors would be paid as much as if he let his claim stand, expressing the belief that, if he did, he would get what was due him. In a couple of days Mr. Wolf appeared, and stated that he had been disappointed in his expectations and had not got the money, and after a discussion, in which Mr. Ruthrauff participated, of means which were available to secure the note, the account against the lumber company was offered and accepted, and the assignment followed.

These are not all the facts. but they are the main ones, and give a fair idea of the situation; and the question is what is to be deduced therefrom. It was plain, of course, that the Wolf Company was in embarrassed circumstances. Its debts were known to be large, its operations extended, and some of them, at least, unprofitable, and new capital was needed to carry on the business. The proposed reorganization had also failed, at least with the existing syndicate, and the money advanced by them had got to be repaid shortly. But, on the other hand, it did not follow, from any or all of this, that the company was insolvent in the sense that its assets were not sufficient at a fair valuation to satisfy its obligations. If its debts were large, so was its plant and its business; its machinery being sold all over the United States, and even as far as Japan and China. In the proposed reorganization preferred stock to the amount of \$400,000 was to be issued, and a like amount of common; the syndicate who were to finance the operation putting up \$150,000 to take care of the outstanding bonds and getting \$180,000 of each kind of stock, and W. G. Wolf on his part receiving \$170,000 of each, leaving \$50,000 of each in the treasury. If figures of this magnitude were at all justified, as they apparently were in the contemplation of the parties, it was hardly suggestive of insolvency. It is true that the reorganization had fallen through; but, as explained by Mr. Wolf, the option was withdrawn at his instance, because he had not been fairly treated in the appraisalment, and not necessarily, therefore, because the syndicate was not satisfied to go on with it, or to go on upon another basis.

It is said, however, that along in November or December, which was about the time that the expert accountants closed their examination, Allender had said to John T. Pensinger, another salesman, that he had heard bad reports about the company, and that, if they were true, the chances were that he would lose a lot of money; and Gladhill says that Allender knew the result of the examination, as every one did about the office, and discussed it with him frequently before the time of the transfer. But, on the other hand, Gladhill admittedly told Allender in November that he believed the company was solvent, and Pensinger, although a director, says that the suggestion of Allender was an entire surprise to him; while Walk, the treasurer, says that the report of the experts, which was not made until the middle of December and was kept from the public, was the first that he knew otherwise. The fact, also, on which some stress is laid, that, as was known to Allender, the company had sent out letters to creditors requesting an extension, and asking them to accept the notes of Aug. Wolf & Co. in settlement, is met by the further fact that this was done in pursuance of the scheme of reorganization, and according to H. G. Wolf, the president, had resulted in putting them in far better shape than they had been. While, then, there may have been abundant signs of embarrassment, the same cannot be charged as to insolvency. The most that can be said is that there was enough to put Mr. Allender on inquiry. But where could he inquire, that he had not? Or what further could he hope to elicit? He had appealed to H. G. Wolf, not only as an officer of the company, but as a friend, putting him on his honor, and had been assured by him of the safety of his debt. He had again gone to Walk, the treasurer, more than once, and, while his statements were somewhat noncommittal, they certainly were not alarming. He had also consulted Mr. Ruthrauff, a local attorney, who had in turn gone to Sharpe and Elder, the attorneys engaged in the reorganization; and surely he did not need to repeat all this, or to call for new assurances. Nor can he be charged with notice that the condition of the company was other or different than had been so represented to him. The suggestion of Gladhill that Allender knew what the experts had reported, and had discussed it with him, is denied by Allender, and, aside from this, is too general and sweeping a statement to be accepted as proving actual knowledge, as is the finding of the master based upon it. He may have known that the report was unsatisfactory, as was evident, because the reorganization was not carried out as contemplated. But that is far from knowing that it showed the company to be insolvent. Nor did he manifest any more anxiety about his claim than he had before that, as would have been the case if he had such knowledge. The idea that Allender could go to the books is not to be thought of. Neither could he expect to get access to the report of the experts, if it had been asked for. It is not intimate and inaccessible information, such as this, that a creditor is bound by, but that which is open to observation and will yield to reasonable inquiry, where it has not been expressly brought home to him. No doubt, in the present instance, Allender was anxious over his debt, and pressed for its payment, and may have expressed apprehension with regard to it. But this is not to be carried too far, nor made to operate too strongly

against him, particularly in view of the assurances which he had received from those best calculated to know, on which he had the right to rely, to the contrary.

The special master has made an admirable report, from which I may well hesitate to differ, although his findings in some respects go further than seems to be warranted by the evidence, notably at the close of the seventh and tenth paragraphs, and possibly in other places. His conclusion, also, that the assignment was executed without authority, was abandoned at the argument. But he is particularly mistaken, as I am constrained to feel, in holding that, all things considered, there was reasonable cause to believe that the company was insolvent, so as to make the transfer of the security in question a preference which further inquiry, if prosecuted, would have disclosed. This, in my judgment, cannot be sustained; and, the transfer being otherwise valid, the money realized on the account which was assigned to the petitioner must be turned over to him to apply on his claim.

And it is so ordered.

TITLE GUARANTEE & TRUST CO. et al. v. WARD, Collector of Internal Revenue.

(Circuit Court, N. D. New York. September 28, 1908.)

1. INTERNAL REVENUE (§ 8*)—LEGACY TAXES—"VESTED LEGACY."

A testator, who died in March, 1901, devised and bequeathed his residuary estate to trustees, to hold and manage the same during the lives of the two surviving children of the testator who should be the youngest at the time of his death and for so much longer as permissible under the laws of the state. The trustees were directed to set apart a sufficient sum to produce a certain amount of income to be paid to the widow during her life, and to pay the income from the remainder in equal parts to the four children of the testator named, or to their issue or devisees in case of their death, subject as to a part thereof to certain charges to pay off liens on property. At the termination of the trust the corpus of the estate was to be divided equally between the four children or the devisees, legatees, assigns, or legal heirs of any deceased. *Held*, that each of the four children took at once a vested estate in one-fourth part of the testator's residuary estate, having the immediate right to dispose of the same by deed or will, and to enjoy a part of the income, subject to no contingency, possession of the corpus alone being deferred; that such gifts took effect at once "in possession or enjoyment," and became subject to the legacy tax imposed by War Revenue Act June 13, 1898, c. 448, § 29, 30 Stat. 464 (U. S. Comp. St. 1901, p. 2307), and that the taxes paid thereon were not recoverable under Act June 27, 1902, c. 1160, § 3, 32 Stat. 406 (U. S. Comp. St. Supp. 1907, p. 652), as having been assessed on contingent interests which had not become vested prior to July 1, 1902 (citing Words and Phrases, vol. 8, p. 7304).

[Ed. Note.—For other cases, see Cent. Dig. § 12; Dec. Dig. § 8.*]

2. INTERNAL REVENUE (§ 8*)—LEGACY TAXES.

The interests of the children, however, in the portion of the estate to be set apart for the benefit of the widow during her life, did not become vested either in possession or enjoyment during her lifetime, but became subject to tax on her death, which occurred prior to July 1, 1902.

[Ed. Note.—For other cases, see Cent. Dig. § 12; Dec. Dig. § 8.*]

*For other cases see same topic & § NUMBER in Dec. & Am. Digs. 1907 to date, & Rep'r Indexes

This action is brought by the executors of the last will and testament of James Jennings McComb, deceased, to recover \$73,373, with interest, paid to the defendant, as collector of internal revenue, under protest, as a tax levied and collected under the provisions of Act June 13, 1898, c. 448, §§ 29, 30, 30 Stat. 464, 465 (U. S. Comp. St. 1901, pp. 2307, 2308).

George A. Strong, for plaintiffs.

George B. Curtiss, U. S. Atty., and Taylor L. Arms, Asst. U. S. Atty., for defendant.

RAY, District Judge. James Jennings McComb, a resident of the county of Westchester, N. Y., died March 31, 1901, leaving a last will and testament which, as to his residuary estate, contained the following provisions, viz.:

"Fifteenth. All the rest, residue and remainder of my estate of what kind soever, whether real or personal, and wheresoever situated, I give, devise and bequeath to my executors and trustees and to their successors in trust to hold, invest, maintain and manage during the lives of those two of my children who, surviving me, shall be the youngest of my children at the time of my death and for such time thereafter if any as may be permissible by and under the laws of the state of New York upon the trusts and for the purposes stated below, to wit:

"(1) To raise and set aside such sums as may be required and may not otherwise have been provided to secure and meet the payments directed in the preceding clauses of this my will and to make such payments in accordance with the terms of said will.

"(2) To set aside and separately invest a sum sufficient to insure an annual income of twelve thousand dollars and to pay such income in monthly, semi-annual or quarterly installments as she may request to my wife Mary Esther McComb during her life, and, upon her death to dispose of said sum as is hereinafter directed in respect to the principal of my residuary estate.

"(3) From the income of said residuary estate not otherwise disposed of, to pay the sum of six thousand dollars per annum, in semiannual or quarterly installments, to each one of my four children, to wit: Mary Alice, Fanny Rayne, Lillie and Jennings Scott, and to apply the remainder of said income during the continuance of this trust to the payment and satisfaction of all liens or mortgages upon the aforesaid Central Park Apartment Buildings until all said liens and mortgages shall have been paid off and satisfied and then to divide the said remaining income equally among and pay the same in equal parts to my four children above mentioned, paying to the issue or devisee of any child dying before the termination of said trust, the parent's share and distributing equally among the surviving children the share of any who may have died without issue and intestate.

"(4) Upon the termination of said trust, to pay and satisfy any liens or mortgages upon said Central Park Apartment Buildings then remaining unpaid and thereupon to pay, transfer and convey said residuary estate in equal parts, share and share alike, to my said children above named, or to their respective heirs, legatees, devisees, next of kin, executors, administrators or assigns.

"It is my desire that the Central Park Apartment Buildings shall continue to be held as one property and in the name of my family so long as practicable and I therefore request my children to agree among themselves to such distribution of my residuary estate as will leave my son, Jennings Scott, should he survive said trusts, in possession of said buildings as owner thereof, but I do not make this request a peremptory direction, nor do I intend hereby to disturb the equality of division among my children.

"Should the trusts of this article of my will terminate while any one of my children is less than forty years of age I direct my executors and trustees, if the laws of the state of New York permit them to do so, to defer the payment of

one-half the principal share of any of my children under such age in such way that a final payment of one-half said share will be made when the beneficiary attains the age of forty years.

"It is my will and I direct that interest on all the legacies and bequests made by this my will, shall commence at and be reckoned from the time of my death."

This will and the codicils thereto were duly proved and admitted to probate in the county of Westchester, N. Y., on the 23d day of April, 1901, on which day letters testamentary were duly issued to the plaintiffs. This was prior to the repealing act (Act April 12, 1902, c. 500, 32 Stat. 96 [U. S. Comp. St. Supp. 1907, p. 646]), and the refunding and qualifying act (Act June 27, 1902, c. 1160, 32 Stat. 406 [U. S. Comp. St. Supp. 1907, p. 652]). However, section 3 of the act of June 27, 1902, has application here if the case is within its provisions. That section reads as follows:

"Sec. 3. That in all cases where an executor, administrator, or trustee shall have paid, or shall hereafter pay, any tax upon any legacy or distributive share of personal property under the provisions of the act approved June thirteenth, eighteen hundred and ninety-eight, entitled 'An act to provide ways and means to meet war expenditures, and for other purposes,' and amendments thereof, the Secretary of the Treasury be, and he is hereby, authorized and directed to refund, out of any money in the treasury not otherwise appropriated, under proper application being made to the Commissioner of Internal Revenue, under such rules and regulations as may be prescribed, so much of said tax as may have been collected on contingent beneficial interests which shall not have become invested prior to July first, nineteen hundred and two. And no tax shall hereafter be assessed or imposed under said act approved June thirteenth, eighteen hundred and ninety-eight, upon or in respect of any contingent beneficial interest which shall not become absolutely vested in possession or enjoyment prior to said July first, nineteen hundred and two."

The decision of this case depends upon the nature and quality and extent of the estate or interest vested in the four children of the testator, James Jennings McComb, viz.—Mary Alice, Fanny Rayne, Lillie, and Jennings Scott.

The testator named executors and trustees, and to them he devised and bequeathed all the rest, residue, and remainder of his estate, both real and personal, in trust, however, to hold, invest, maintain, and manage during the lives of those two of his children who, surviving him, should be the youngest of his children at the time of his death, and for such longer time as the laws of New York would permit, and upon the trusts and for the purposes: (1) To raise and set aside certain sums to satisfy certain payments directed by preceding clauses of the will; (2) to set aside and invest a sum that would secure an annual income of \$12,000 to his wife; (3) from the income not otherwise disposed of to pay \$6,000 per annum to each of his four children, naming them; (4) the remainder of the income to be used during the life of the trust to pay liens on the Central Park Apartment Buildings (part of his residuary estate) until paid off, and then to pay the remaining income to such four children, paying to the issue or devisee of any child dying before the termination of the trust the parent's share, and "distributing equally among the surviving children the share of any who may have died without issue and intestate"; (5)

on the termination of the trust to satisfy any lien on such apartment building and thereupon to pay, transfer, and convey the residuary estate in equal parts, share and share alike, to the said children, or to their respective heirs, legatees, devisees, next of kin, executors, administrators, or assigns. In case the trust should terminate while either child was under 40 years of age, then, if the laws of New York would permit, he directed payment over of the share of such child in the principal deferred until he or she should reach the age of 40 years. It will be noted that, subject to the deductions for the purposes mentioned, each of the four children takes a present vested estate in the one-fourth part of the residuary estate, which is descendable, devisable, bequeathable, or assignable, which may be transferred by will, or by deed or bill of sale. They are to enjoy the income, except as stated; but possession of the corpus of the estate, of the share, is deferred until the termination of the trust—possibly until each child, respectively, reaches the age of 40 years. In no event or contingency is the title to the share of any child in the principal defeated. There is no contingent remainder or contingent estate as to the principal. Each child enters into the enjoyment of a part of the income at once. Each child may deed, or sell, or will away his or her share of the principal at once, and, in case he or she does not, then his or her heirs and next of kin take on his or her death. Possession of the principal is deferred—not beneficial enjoyment of the whole of the income therefrom. In no event is title defeated. In no event is the title contingent. It is not the case of vesting, subject to being divested on the happening of some event, in some certain contingency.

In plaintiff's reply brief he says that this may be conceded. The plaintiff, however, contends that, to be taxable under the provisions of the law referred to, the shares must be vested, not only in title, but in both possession and enjoyment, and cites *Vanderbilt v. Eidman*, 196 U. S. 480, 489, 490, 25 Sup. Ct. 331, 49 L. Ed. 563, as supporting this contention. The government, however, contends that the case cited holds no such doctrine, but, on the other hand, holds that a share is taxable when absolutely vested in title and beneficial enjoyment of the use and income in whole or in part, even if possession or payment over of the principal sum be deferred for a limited period; that is, if the title is given absolutely, with an absolute, indefeasible right to the receipt and possession and use of the rents and income, in whole or in part, and an absolute, indefeasible right to dispose of the principal, which, of course, goes with absolute title, then it is taxable, even if payment over or delivery of the principal is deferred for a lawful period.

What does the *Vanderbilt Case* decide? It is clear that the court was not called upon to decide any such proposition as is contended for by the plaintiff here. In that case *Alfred G. Vanderbilt*, aside from the income, had but a contingent estate. If vested in any sense, his estate or title as to all not paid over to him was subject to be divested on the happening of a certain event, viz., his death before attaining the age of 35 years. In that event the share of which he had the income, or so much as was not paid over when he became 30 years of age, if he lived to attain that age, was to be divided amongst his children,

if any, and in default of issue then such share was given to another son of the testator, Reginald C. Vanderbilt. When Alfred G. reached the age of 30 years he was to have one-half the principal paid over to him. If, however, he died before reaching the age of 30, then the whole principal went to his children, if any, and, if none, then to his brother, Reginald C. There Alfred G. had no power of disposition of the principal, by will or otherwise. If he lived to the age of 30 years, he became absolute owner of the one-half; but, if he did not, then his heirs and next of kin, legatees, and devisees took nothing from him, but his children, if any, took under the will of the testator creating the trust. If he left no child or children, it was given to his brother. There, as here, the property was given and held in trust by trustees, so that Alfred G. had no possession of any part of the principal, and was not to have, until he reached the age of 30 years. That case differs from this, in that there Vanderbilt had an estate, if he had any, subject, as to the principal fund, to be defeated and divested absolutely and entirely by his death before reaching the age of 30 years, and subject, as to one-half the principal fund, to be defeated absolutely and entirely by his death after reaching the age of 30 and before attaining the age of 35 years. His estate was not vested absolutely, in ownership or in possession, but was in the enjoyment of the income. Here the estates of the children of the testator, McComb, are vested absolutely in ownership, in enjoyment of a part of the income, but not in possession. In the Vanderbilt Case the beneficiary of the trust, Alfred G., had no right or power to dispose of the principal, or any part of it, in any way or by any means, while here the right of the children of McComb to dispose of their several interests at any time and in any manner is absolute and unqualified.

In the Vanderbilt Case did the Supreme Court decide that, to be taxable in present, the estate or property must be vested in title, in full enjoyment of the income, and also in possession? If so, that ends this case. It will be noted that in the Vanderbilt Case, if there was any vesting of the title, it was a technical vesting, while here the estates are absolutely vested both in title and enjoyment of the income to an extent. There the court was speaking of the case before it and of such a technical vesting. There the will gave title to one-half the residuary estate to Alfred G. when he attained the age of 30 years, if he did attain that age, to his children, if any, in case he did not, and, if no child, then to his brother. As to the other one-half the will gave him title if he attained the age of 35 years, gave title to his child or children, if any, in case he did not attain that age, and in such event, in default of children, gave it to his brother. There the tax was levied on an estate or property that might be given by the will to Alfred G., or to his children, or to his brother, depending on subsequent events. The Supreme Court held that the corpus of such an estate passing by will was not taxable until it should be ascertained who was the donee, the legatee, or devisee entitled to take. But here there is no such indefiniteness or uncertainty. The absolute title of each share, except mere possession of the principal and certain changes in the income, is given by the will to each child, respectively. The child of the testator can dispose of the title thereto. No other

person can. Such child has and enjoys the income absolutely, subject to the interest of the widow and certain payments on liens on a part of the property. At common law the title and estate of each child is vested, not technically, but absolutely; not in possession, however, but no power or event, save the voluntary act of the child of the testator, can divest that title. His or her death does not, for in that event the title goes according to his will or deed, or according to the law in cases of intestacy, not under the will of McComb.

According to the contention of the plaintiff no estate passing by will was taxable under the act in question, where possession or payment over by the executor or trustee of the principal was deferred until a subsequent time. If the Supreme Court of the United States so decided in *Vanderbilt v. Eidman*, supra, the plaintiff must prevail. I think the keynote of the holding of that case is found in the language used at page 495 of 196 U. S., at page 335 of 25 Sup. Ct. (49 L. Ed. 563) viz.:

"In view of the express provisions of the statute as to possession or enjoyment and beneficial interest and clear value, and of the absence of any express language exhibiting an intention to tax a mere technically vested interest in a case where the right to possession or enjoyment was subordinated to an uncertain contingency, it would, we think, be doing violence to the statute to construe it as taxing such an interest before the period when possession or enjoyment had attached."

The language is explicit that the statute discloses no intent to tax—"a merely technically vested interest in a case where the right to possession or enjoyment was subordinated to an uncertain contingency."

And after thus describing the interest the court says: .

"It would, we think, be doing violence to the statute to construe it as taxing such an interest before the period when possession or enjoyment had attached."

That the interests of the children of McComb are not such an interest is clear. Their interests are neither technically vested interests, nor is the right to enjoyment subordinated to any uncertain contingency. The absolute right to possess and enjoy the income, subject to certain charges, and to dispose of the principal by will or otherwise, attached immediately on the death of McComb, and the right to the possession of the principal is fixed at definite and certain times. As to the children of the testator, McComb, these periods can neither be accelerated nor retarded. Again, at page 490 of 196 U. S., at page 334 of 25 Sup. Ct. (49 L. Ed. 563), speaking of the plaintiff's contention in the *Vanderbilt Case*, the Supreme Court said:

"In other words, the proposition is that the act did not make subject to taxation a gift, which, even if technically vested in title, was yet subject to be defeated in possession or enjoyment by the happening of a contingency stated in the will. The argument, therefore, is that, when such a gift was made by will, no tax could be imposed until the time when, by the happening of the contingency stated, the right to possess or enjoy had accrued."

And again, at pages 492, 493, of 196 U. S., at page 334 of 25 Sup. Ct. (49 L. Ed. 563), says the court:

"As to this second class [personal property transferred by deed, grant, bargain, sale, or gift] the statute specifically makes the liability for taxation de-

pend, not upon the mere vesting in a technical sense of title to the gift, but upon the actual possession or enjoyment thereof."

We have a constant recurrence to the expression "vested" or "vesting" in a "technical" sense, demonstrating that the court was all the time speaking of estates, not vested in fact, but which the law for purposes of convenience treat as vested. The language of the statute is:

"Sec. 29. That any person or persons having in charge or trust, as administrators, executors, or trustees, any legacies or distributive shares arising from personal property, where the whole amount of such personal property as aforesaid shall exceed the sum of ten thousand dollars in actual value, passing after the passage of this act, from any person possessed of such property, either by will or by the intestate laws of any state or territory, or any personal property or interest therein, transferred by deed, grant, bargain, sale, or gift, made or intended to take effect in possession or enjoyment after the death of the grantor or bargainor, to any person or persons, or to any body or bodies, politic or corporate, in trust or otherwise, shall be, and hereby are, made subject to a duty or tax, to be paid to the United States, as follows—that is to say." Act June 13, 1898, c. 448, 30 Stat. 464 (U. S. Comp. St. 1901, p. 2307).

The words are: "Intended to take effect in possession or enjoyment." I am of opinion that when the estate is absolutely vested in ownership, with absolute right of disposition, and is accompanied by the absolute right to enjoyment of the income, so far as given by the will, present possession or present right of possession of the property itself is unnecessary, and that such interest is presently taxable. I do not think that in this connection "possession" means the same as "enjoyment." If the gift of the principal is absolute, then either possession thereof or the right to enjoy the income so far as given is all-sufficient. Neither the statute nor the language of the Supreme Court reads "possession and enjoyment" but "possession or enjoyment." If the personal property is absolutely given by will by an indefeasible title, and is accompanied by a present right to the possession and use of the income so far as given by the will, possession of the principal for a limited time by the trustee does not defer the imposition and collection of the tax until the time for payment over.

Applying the rule contended for, had the war continued and the act remained in force, the government would have received no present, substantial benefit from the tax, as many, if not all, testators, while giving absolute title and the entire income beneficial use, would have deferred payment over of bequests until a future day. The legatees named in the residuary clause of the will of James Jennings McComb took vested estates in the residuary estate, as contradistinguished from technically vested estates, and beneficial interests, capable of absolute and certain valuation. Their absolute title was not uncertain, or liable to be defeated by the happening of any event or in any contingency. *Vanderbilt v. Eidman*, *supra*, decides nothing to the contrary. Repeating, the court, at pages 498 to 501 of 196 U. S., page 331 of 25 Sup. Ct. (49 L. Ed. 563), refers to the fact that estates vested in possession or enjoyment were taxable. The language is not, as claimed by the plaintiff here, "vested in possession and enjoyment." And the court, at page 501 of 196 U. S., page 338 of 25 Sup. Ct. (49 L. Ed.

563), refers to *Clapp v. Mason*, 94 U. S. 589, 24 L. Ed. 212, as interpreting Act July 1, 1862, c. 119, 12 Stat. 432, 485, levying war taxes, and in substance says that that act, as interpreted in *Clapp v. Mason*, supra, meant exactly what the act of 1898, now under consideration, means. Turning to *Clapp v. Mason*, 94 U. S. 592, 24 L. Ed. 212, and to Act June 30, 1864, § 137, c. 173, 13 Stat. 289, there quoted, we find the taxes were properly and legally levied, and became due and payable—

“when the successor or any person in his right or his behalf should become entitled in possession to his succession, or to the receipt of the income or profits thereof.”

This makes clear what the court meant in *Vanderbilt v. Eidman* by “vested in possession or enjoyment”; that is, under both acts, that of 1862 and 1898, the tax was assessable and payable when the donee of the gift came into actual possession of the gift, or of the income or profits.

By the plaintiff I am cited to *Land, etc., Co. v. McCoach*, 129 Fed. 901, 64 C. C. A. 333, *Herold v. Shanley*, 146 Fed. 20, 76 C. C. A. 478, *Disston v. McClain*, 147 Fed. 114, 77 C. C. A. 340, and *Union, etc., Co. v. Lynch (C. C.)* 148 Fed. 49. Neither of these cases, unless it be *Herold v. Shanley*, or *Union Trust Co. v. Lynch*, supports the plaintiff's contention here.

In *Land, etc., v. McCoach*, supra, the residuary estate was given to trustees, in trust to pay the income to his wife during her life, with remainder to his children living at her death, if any, and the lawful issue of any deceased child or children; the issue taking the parent's share. The remainder was not vested in any child, except technically. The remainder was not limited to persons in esse and ascertained, but was given to persons who could not be ascertained until the death of the wife. The children had neither title nor beneficial use. They could not sell or dispose of their contingent or prospective shares and give title. If one died childless before the death of the wife, he or she took nothing. If one died leaving a child or children, such child or children took the parent's share. Clearly these interests were not taxable until it was ascertained who would take.

In *Herold v. Shanley*, supra, \$100,000, and in a certain event \$150,000 more, were given in trust, the income to be expended for the support, etc., of the testator's grandson until he should arrive at the age of 21 years. On his arrival at that age such sums were to be paid to him. If he did not live to reach that age, then the said sums reverted to, or fell into and became a part of, the residuary estate. Clearly this grandson had nothing but the income and an estate in expectancy in the \$250,000. It was contingent, and liable to be defeated by his death before reaching the age of 21 years. As to the residuary estate, the net income was given to his wife and three sons, share and share alike, until the death or marriage of his wife. In either event her interest ceased and—

“thereupon I direct that all the rest, residue and remainder of my estate, real and personal, subject to the provisions above written for the benefit of my grandson, shall be distributed and divided among my three sons, share and share alike.”

The case is silent as to the disposition of the residuary in case either son died before the death or remarriage of the wife. Judge McPherson, in giving the opinion of the court, held this immaterial, and construed *Vanderbilt v. Eidman* as so holding. At page 23 of 146 Fed., at page 481 of 76 C. C. A., he says, referring to that case:

"Remainders over were limited in case he (Alfred G.) should die before reaching the age of 30 or 35, but these were not regarded as material to the construction of the clause."

I do not so read the decision of the Supreme Court and differ from the learned court in *Herold v. Shanley*. Those limitations over were what made the estate of Alfred G. Vanderbilt a "technically" vested estate, instead of one absolutely vested in title and interest, everything except actual possession of the corpus of the estate, and led the Supreme Court to constantly draw the distinction between "vested estates," and "technically vested estates," and to hold that the latter were not presently taxable. The fact that payment over of the corpus of the estate is deferred, if there be a present absolute gift thereof, accompanied by the present enjoyment of the income, does not prevent the absolute vesting, and in such case there is no "technical" vesting. The cases will be cited and quoted from later. But see 8 Words and Phrases, tit. "Vested Legacy," p. 7304.

If the Supreme Court, in *Vanderbilt v. Eidman*, intended to hold that estates absolutely vested in title and enjoyment of the income, possession of the corpus alone being deferred, were not taxable presently, it would have been easy to so say, and all the reasoning and nice discriminations made in the opinion of the court, especially the language quoted, would have been unnecessary. As I read the case, the court held that the estate or interest of Alfred G. Vanderbilt was not presently taxable, for the reason that the share was not given him absolutely, with absolute power of disposition, but the gift was subject to be defeated by his death before attaining the age of 35 years, and was therefore only "technically vested"; that is, the estate, if regarded as vested, was liable to be divested by his death before reaching the prescribed age. The right of Alfred G. to the income was absolute. His right to the principal was uncertain and contingent. If this is not the decision, then the language of the Supreme Court quoted is meaningless and was unnecessary. And, to repeat, the court in *Vanderbilt v. Eidman* held that the act of 1898 is in effect the same as that of 1862, and means the same, and there the tax was due and payable when the donee came into possession of the estate, or into the receipt of the income or profits thereof. The McComb children came into the receipt of the income before the tax was levied.

In *Disston v. McClain*, supra, Rachael Asch was given \$15,000 per year in quarterly payments, same to cease on her death. Who was to take the corpus on her death was uncertain. The commissioner of internal revenue took such a sum as would produce \$15,000 per year as her interest, and taxed that sum. This was clearly erroneous. The case had nothing to do with the bequest of a fixed sum absolutely, with present enjoyment of the income; payment over of the principal alone being deferred. The case is not in point. In the case at

bar there is nothing "contingent" about the estate of the children of the testator, except actual possession of the principal. But that is not the estate given by the will. The estate or interest given is absolute and certain. It takes effect in title and beneficial enjoyment at once, but not in possession of the corpus. "A contingent estate depends for its effect upon an event which may or may not happen; as an estate limited to a person not in esse, or not yet born." 1 Bouvier; Crabb, Real Property. A contingent legacy is "a legacy made dependent upon some uncertain event." 1 Bouvier; 1 Roper, Legacy, 506. It is "a legacy which has not vested." Williams on Executors.

"On the subject of what constitutes a vested or contingent legacy, this court has in many cases iterated and reiterated the rule of the courts in England that, where there is a substantive bequest or gift of a sum of money to be paid at a future time, the legacy is vested; but, where there is no antecedent debt or bequest independent of the period fixed for payment, then it is not vested, but contingent. *Magoffin v. Patton*, 4 Rawle (Pa.) 113; *Appeal of Seibert*, 19 Pa. 49, 56; *Lamb v. Lamb*, 8 Watts (Pa.) 184 (cited in *Appeal of Bowman*, 34 Pa. 19, 23). * * * A legacy is not said to be vested, except where a legatee has power to extinguish by release or give perfect title by assignment. Where words of futurity are annexed to the substance of the gift, and there is nothing in the will to manifest a different intention, the gift itself will be deemed future, and the question of who is the beneficiary will be deemed dependent on the state of facts when that future time shall arrive. And in this class of cases the legacy is said meanwhile not to be vested, although, if it were an estate in real property given by the same language, it would technically be called a 'vested,' as distinguished from a 'contingent,' remainder. *Talmadge v. Seaman*, 85 Hun, 242, 32 N. Y. Supp. 906, 908 (citing *Delafield v. Shipman*, 18 Abb. N. C. [N. Y.] 300, note). When a legacy is directed to be paid at a future time, or on a future event, it is vested or contingent, according to the intent of the testator as expressed in his will. If the time or event is annexed to the payment of the legacy, it is vested; if to the substance or gift of the legacy, it is contingent. Therefore, if a legacy be given to a person payable or to be paid at or when he shall attain the age of 21 years, or at any other definite period or event, the legacy becomes vested immediately upon the testator's death, and is transmissible to the will or administration of the legatee, though he die before the time of payment. But if the words 'payable' or 'to be paid' are omitted, and the legacy is given at 21, or at or upon any future period, the interest is contingent, and depends for its vesting on the legatee being alive at the period or event specified. *Rubecane v. McKee*, 6 Del. Ch. 40, 6 Atl. 639, 641 (citing *Conwell's Adm'r v. Heavilo's Adm'r*, 5 Har. [Del.] 296). A legacy is contingent, and not vested, when the payment thereof is deferred for reasons personal to the legatee. Thus a will directing the trustee, on the death of a life tenant, to pay out of the residuary estate a certain amount to each of two nephews of testatrix when they shall reach majority, and, in case either die before that age, to pay his legacy to the survivor, creates contingent, and not vested legacies. In *re Engles' Estate*, 166 Pa. 280, 31 Atl. 76, 78. If a legacy, charged upon the personal estate only of the testator, be given unconditionally, and dependent upon no future contingency, then, though the day of payment be postponed, as if it is to be paid when the legatee attains the age of 21 years, or marries, or some other contingency happens, yet, if the legatee die before that day, his representatives shall take. It is a vested legacy. It cannot fail. *Fairly v. Kline*, 3 N. J. Law, 754, 758, 4 Am. Dec. 414."

Fearne (Fearne, Con. R. 1) subdivides vested estates into (1) estates vested in possession and (2) estates vested in interest, and distinguishes and contrasts both with contingent estates. It is a settled rule that:

"Where futurity is annexed to the substance of a gift made by will, the vesting is suspended; but if the gift is absolute, and the time for payment over only is postponed, the gift is vested." *Smith v. Edwards*, 88 N. Y. 103; *Miller v. Gilbert*, 144 N. Y. 68, 73, 38 N. E. 979.

See, also, *Fowler's Real Property Law*, State of N. Y. 209, etc.

There is another rule of construction referred to in *Smith v. Edwards*, supra, which should not be lost sight of. But it is not controlling here for several reasons. It is that:

"Where there is no gift, but by a direction to executors or trustees to pay or divide at a future time, the vesting in the beneficiary will not take place until that time arrives." *Shipman v. Rollins*, 98 N. Y. 311, 327; *Schlereth v. Schlereth*, 173 N. Y. 444, 449, 66 N. E. 130, 93 Am. St. Rep. 616.

However this rule is not inflexible, and is to be applied in subordination to the testator's intention, appearing from the entire will. *Matter of Young*, 145 N. Y. 535, 538, 40 N. E. 226; *Matter of Brown*; 154 N. Y. 313, 325, 48 N. E. 537; *Roosa v. Harrington*, 171 N. Y. 341, 348-351, 64 N. E. 1. As said in *Smith v. Edwards*, supra, and quoted with approval in *Roosa v. Harrington*, supra:

"It applies only where, beyond the direction for future distribution, there are no words and no provisions which import a present or vested gift, or indicate such an intent."

Here, over and beyond the mere direction to pay over to the children of the testator named on the termination of the trust, we have words which clearly import an absolute gift in praesenti to, and a vested estate in, the children named. The payment over of the corpus of the residuary estate is to be made in equal shares to the children themselves, if living; but, if either child be dead, then payment, transfer, and conveyance by the trustees is to be made of that share to his or her heirs, legatees, devisees, next of kin, executors, administrators, or assigns. As to the real estate held in trust, the child may devise by will or convey by deed at any time during the life of the trust, and as to personal property it may be assigned or bequeathed by will; but, if not disposed of in either manner, then it goes, as the property and estate of the child so dying, to his or her heirs, or, if personal, to his or her executors or administrators. It seems clear to me that the will of *McComb*, while containing no words like "I give," "I bequeath," or "I devise," as to the residuary estate, contains equivalent words, and that it is plainly indicated that the testator intended a present gift absolute, except as to possession and a charge on the income. This residuary estate was in existence, its amount easily ascertained, and was subject to no uncertainty. By giving enjoyment of the income and absolute power to dispose of the principal, it seems to me, the testator intended a vested estate.

In view of my conclusions that the estates of the children in the residuary were vested estates, as distinguished from technically vested estates; that the right to possession or enjoyment is not subordinated to any uncertain contingency; that the children came immediately into the possession and beneficial enjoyment of the rents and income subject to certain charges; that the Supreme Court, in *Vanderbilt v. Eidman*, has decided that the act of 1898 means the same as the act

of 1862, and is to be given the same construction as to the time when the tax should be assessed and becomes due and payable; and that that act expressly provided that "the duty imposed by this act shall be paid at the time when the successor, or any person in his right or his behalf, shall become entitled in possession to his succession, or to the receipt of the income or profits thereof"—I think the tax in question was in part legally assessed, and was due and payable at that time. But it is clear that the whole residuary estate was not presently taxable. Of that part set aside or apart for the use of the widow, separated for that purpose, the children had no enjoyment, and were not to have any, until the death of the widow. They were not to have possession or enjoyment of that until the death of the widow. It was vested in title only. But the widow died July 3, 1901, and hence that sum so set apart for her then fell into the residue and the income went to the children named. That part then became taxable, and was properly taxed. From the evidence and papers before me I am unable to find that any tax was levied and collected on any part of the estate of which the children named did not have the use or income. If any part of the sum paid is a tax on such a part of the residuary estate, it may be pointed out on the settlement and signing of the judgment, and will be deducted.

The plaintiff contends that something over \$4,000 was paid as interest on the tax. This interest demanded and paid covers the time which elapsed while the parties were engaged in a settlement, or an attempted settlement, of the legal amount of tax to be paid. This was a friendly dispute or contention. No disposition was shown to evade the payment of any lawful tax, and there was no wrongful withholding of any sums. But this was not a case of unliquidated damages or of a disputed account. The law fixed the tax and the time when due, and it seems to me that when return was made and the tax fixed by the government it became due as of the time fixed by law, and drew interest, even if there was a prolonged dispute as to the amount or the legality of the tax.

The plaintiff claims to be entitled to recover \$8,142.77, or about that sum, and interest, of the sum paid, on the theory that the tax assessed, claimed, and paid was excessive by that amount. I find no evidence that it was in fact excessive, except the returns and some letters and figures, which show that the commissioner of internal revenue admitted errors prior to October 18, 1906, and on that day made a statement in writing of the tax actually due at the date the assessment was made, giving figures. As the admission and figures appear to be correct in fact, based on the amount and value of the estate passing, or the estates passing, I think it clear that the plaintiffs are entitled to recover the sum of \$8,142.77 and interest thereon from the time paid, and also the amount of interest paid on that sum from the time the assessment was made to the time of payment of the tax, as that amount of interest was illegally exacted.

There will be a judgment accordingly.

MATHIESON et al. v. CRAVEN et al.

(Circuit Court, D. Delaware. June 1, 1908.)

No. 271.

1. EQUITY (§ 93*)—PARTIES.

A distinction has been recognized between necessary and indispensable parties for the purpose of ascertaining whether some of those who under well-established rules of equity pleading and practice were deemed necessary, may not, under existing rules governing pleading and practice in equity, be dispensed with as parties in order that equitable relief in a given case may not wholly fail.

[Ed. Note.—For other cases, see Equity, Cent. Dig. §§ 252-259; Dec. Dig. § 93.*]

2. EQUITY (§ 93*)—INDISPENSABLE PARTIES.

Persons whose presence in a suit as parties is essential to the granting of the relief sought, and whose absence would render impossible or nugatory any decree for such relief, are indispensable in contradistinction to necessary parties.

[Ed. Note.—For other cases, see Equity, Cent. Dig. §§ 252-259; Dec. Dig. § 93.*]

3. EQUITY (§ 219*)—FAILURE TO SERVE DEFENDANT—DEMURRER.

A demurrer to a bill cannot be sustained on the ground that one against whom process is prayed as a co-defendant and whose presence is essential to the relief prayed, has not been served and has not appeared; for non constat that he will not be so served or voluntarily appear.

[Ed. Note.—For other cases, see Equity, Dec. Dig. § 219.*]

4. COURTS (§ 316*)—FEDERAL COURTS—JURISDICTION—DIVERSITY OF CITIZENSHIP.

Where two persons, entitled to separable although precisely similar claims charged on real estate, joined in a bill for the enforcement of their liens, and the bill was amended by omitting one of such persons in order that it might not fail for want of the requisite diversity of citizenship, and the suit was prosecuted by the other for the enforcement of her own claim, the amended bill stating that the person omitted "consents to the relief sought in this bill and to all proceedings had and to all orders or decrees made or that may be made by the court in this case," *held*, that the circumstances did not disclose collusion and that the bill as amended was not demurrable.

[Ed. Note.—For other cases, see Courts, Dec. Dig. § 316.*]

Diverse citizenship as a ground of federal jurisdiction, see note to *Shipp v. Williams*, 10 O. C. A. 249; *Mason v. Dullaghan*, 27 C. C. A. 298.]

(Syllabus by the Court.)

In Equity.

David T. Marvel, Josiah Marvel, and Walter J. Willis, for complainants.

John H. Rodney, John Biggs, J. Frank Biggs, and Josiah O. Wolcott, for certain defendants.

BRADFORD, District Judge. Thomas Jamison made his will June 3, 1864, and died on or about December 8, 1864. His son Albert Jamison died without issue on or about July 2, 1864. Thomas Jamison left to survive him three sons, Edgar Jamison, Clarence Jamison and Oliver V. Jamison. Edgar Jamison died on or about May 1, 1886, leaving to survive him two children, Vesta L. Jamison, now intermarried with James D. Bastian, and Catherine P. Jamison, now intermarried with

*For other cases see same topic & § NUMBER in Dec. & Am. Digs. 1907 to date, & Rep'r Indexes

George F. Mathieson. The amended bill is filed by Catherine P. Mathieson and George F. Mathieson, and states:

"That the said Vesta L. Bastian consents to the relief sought in this bill and to all proceedings had and to all orders or decrees made or that may be made by the court in this cause."

Thomas Jamison at the time of his death was possessed of certain personal property and seized in fee of three tracts of land, viz: (1) The "Jamison Corner Farm," of about two hundred acres; (2) the "Capelle Farm," of about two hundred and twelve acres, and (3) the "Homestead Farm," of about two hundred and thirty acres, all situate in New Castle County, Delaware. The testator after making sundry bequests, unnecessary to be considered in this connection, and creating a charge of \$4,000 on the "Jamison Corner Farm," devised that farm, subject to the charge, in trust, to permit Albert Jamison, who died in the testator's lifetime, to "use, occupy, rent and receive the rents, issues and profits of said farm during the term of his natural life, for his proper use and benefit," remainder, in case of the death of Albert Jamison without leaving issue, to the testator's sons, Edgar, Clarence and Oliver "and their issue, the heirs and assigns of such issue, subject to the same conditions and limitations as their own shares are respectively subject to, under this will." The testator devised the "Capelle Farm" and the "Homestead Farm" in trust, to rent the same and collect, expend and invest the rents as hereinafter provided, "until the majority of my youngest son who shall live to attain the age of twenty-one years" and thereupon to "raise out of or charge upon the said farms respectively, such sum or sums as shall be necessary to make equal the shares of my sons Edgar, Clarence and Oliver as hereinafter provided, and subject to such charge and conditions"; and in further trust, to permit and suffer "my son Clarence to use, occupy and rent and to receive the rents, issues and profits of the said 'Capelle Farm' during the term of his natural life for his proper use and benefit, and in case of the death of the said Clarence leaving a child or children, or the issue of such, remainder to such child or children, or the issue of such, their heirs and assigns, free and discharged from the aforesaid trust"; and in further trust, to permit and suffer "my son Oliver to use, occupy and rent; and to receive the rents, issues and profits of the said 'Homestead Farm' during the term of his natural life for his proper use and benefit, and in case of the death of the said Oliver leaving a child or children, or the issue of such, remainder to such child or children, or the issue of such, their heirs and assigns, free and discharged from the aforesaid trust." The testator also undertook to create a trust in "my said executor and the guardian hereinafter named and appointed for my minor children * * * to invest all the rest and residue of my estate, not herein otherwise disposed of in bonds and mortgages as aforesaid, interest payable semi-annually and keep the same so invested until the majority of my youngest son who shall live to attain the age of twenty one years," and thereupon he desired "my trustees aforesaid to have the said 'Capelle Farm' and the said 'Homestead Farm' valued at their just and true value in money by three substantial men of the neighborhood, and that to such valuation the trustees shall add the four

thousand dollars and all interest accrued thereon which hereinbefore is charged upon the 'Jamison Corner Farm' and all the rest and residue of my estate invested as first directed in this item and also any other legacies or devises to which my said sons Edgar, Clarence and Oliver may become entitled, and the aggregate sum thus ascertained to apportion in equal shares among my sons Edgar, Clarence and Oliver, and their issue, the issue in all cases taking their parents share." He further provided that "in the said apportionment my said son Clarence to take the said 'Capelle Farm' with such incumbrances or additions as may be necessary to equalize the shares of the said Edgar, Clarence and Oliver, and the said Oliver to take the 'Homestead Farm' with such like incumbrance or addition, but the share of the said Edgar shall be in money invested in good bonds and mortgages as aforesaid, the interest payable to him, after such apportionment, semi-annually during his natural life and from and immediately after his death the principal and all interest accrued thereon payable to his child or children, or the issue of such." He further provided that "the rents and profits arising from the Capelle and Homestead farms and the interest of all sums invested as in this Item prescribed, and so much thereof as shall be necessary shall be expended by the said guardian in the maintenance and education of my said sons, Edgar, Clarence and Oliver" and that the residue, if any, should be "invested for their benefit, first deducting yearly a sum not exceeding one hundred and fifty dollars, to be expended on each of the said farms, to keep the same productive and in good condition." He further provided that "in case of the death of any of my said sons Edgar, Clarence and Oliver without leaving any child or children, or the issue of such, the share of the one so dying shall go to the survivor or survivors, and the issue of such as may be deceased, subject to the same conditions and limitations as their own shares respectively, hereinbefore designated." He further provided that "it is my will and I hereby appoint and request my esteemed friend _____ shall have the guardianship of any child or children living at my decease during the minority of such" and "I nominate and appoint my valued friend Thomas J. Craven my executor and the said executor and guardian, trustees to effectuate the trusts hereinbefore set forth and declared." Oliver V. Jamison, the youngest son of the testator, attained his majority May 1, 1878, and is one of the parties defendant in this suit. Letters testamentary were granted to Thomas J. Craven who was appointed both executor and trustee by the testator, and Craven duly qualified, and undertook the administration of the decedent's estate and accepted the trusts imposed on him by the will. All of the debts and funeral expenses of the testator have been paid by the executor, who also has paid all legacies mentioned in the will except that to Edgar Jamison and his children, Mrs. Mathieson and Mrs. Bastian. Craven, the trustee, soon after Oliver V. Jamison attained his majority, had the "Capelle Farm," the "Homestead Farm" and the "Jamison Corner Farm" valued at their "just and true value in money" by "three substantial men of the neighborhood," the valuation according to the information and belief of the complainants of each of the farms being "upwards of twelve thousand dollars." The amount of the valuation made of the three farms is

unknown to the complainants "other than that they are informed and therefore believe that said valuation was placed at upwards of \$36,000." The bill then avers in substance that the above mentioned sum of \$4,000 directed to be raised out of the "Jamison Corner Farm" and the other sums of money, to be raised respectively out of that farm, the "Capelle Farm" and the "Homestead Farm," necessary to equalize the shares of Edgar Jamison, Clarence Jamison and Oliver V. Jamison "so that the said Edgar Jamison's share would be in money," as provided in the will of Thomas Jamison, were first equitable liens upon those farms from and after the death of the testator; and that the moneys so charged upon the farms were never raised by the executor or trustee, and have never been received in whole or in part by Mrs. Mathieson and Mrs. Bastian, or either of them, and neither they nor either of them have or has released or discharged "the said lands from the said charges or liens," and that the principal of the moneys so charged, together with interest from the death of Edgar Jamison, is now due and payable to them, share and share alike. And, further, that neither the complainants and Mrs. Bastian and her husband, James D. Bastian, nor any of them "ever knew that they were entitled to any interest or estate out of the estate of the said Thomas Jamison until about six months prior to the filing of this bill." The bill also contains allegations, not material to consider at this time, touching the present ownership and occupation of the above mentioned premises, and a certain mortgage held by the Girard Trust Company of Philadelphia against the "Capelle Farm." The second, third and tenth prayers of the amended bill are as follows:

"Second: That the amount due the said Catherine P. Mathieson, both principal and interest, upon the legacy or legacies devised as aforesaid, in and by the will of the said Thomas Jamison, be ascertained and that the said amount when so ascertained be declared to be an equitable lien upon the tracts or parcels of land described as the 'Jamison Corner Farm,' the 'Capelle Farm,' and the 'Homestead Farm' as aforesaid, respectively, and in the proportions as provided in the said will.

"Third: That an account may be taken of what is due said Catherine P. Mathieson, both principal and interest, upon the legacy or legacies devised as aforesaid, in and by the will of the said Thomas Jamison, and that the said amount, when so ascertained, be declared to be an equitable lien upon the tracts or parcels of land described as the 'Jamison Corner Farm,' the 'Capelle Farm' and the 'Homestead Farm' as aforesaid respectively, and in the proportions as provided in the said will.

* * * * *

"Tenth: That the said Thomas J. Craven, trustee, be ordered and directed to raise out of each of the said tracts or parcels of land the sum ascertained to be due said Catherine P. Mathieson and charged respectively upon the said several tracts or parcels of land, or that a trustee be appointed and directed to so raise said amounts due said Catherine P. Mathieson out of the said lands, by sale, mortgage or otherwise, as the court may direct, within three months."

The fourth, fifth and sixth prayers are to the effect that the amounts found due to Mrs. Mathieson on taking an account of the several sums charged against the farms in order to "equalize the shares of the said Edgar Jamison, Clarence Jamison and Oliver V. Jamison, as provided for in the said will," be declared equitable liens thereon "from and after the death of the said testator." The bill also prays for other

and further relief. It is unnecessary now to allude to other prayers of the bill.

Such of the defendants as have appeared have demurred to the amended bill on a number of grounds. In substance, the first is that the bill is without equity, and the last that the defendants, if answerable at all, are answerable only to Thomas J. Craven as trustee under the will of Thomas Jamison. With respect to the first ground, this court is not prepared to hold at this time that the bill, aside from the other grounds of demurrer, is without equity. Whatever questions may arise touching the equity of the bill—and it is possible there may be some requiring serious attention at the proper time—may more intelligently and safely be determined on final hearing and should, therefore, in the exercise of a sound discretion, under the settled practice of this and other courts of equity, be reserved for future consideration. The last ground is clearly untenable. If Mrs. Mathieson has a lien, as she asserts, failure on the part of the trustee to proceed against the defendants to enforce it for her benefit affords no reason why she should be denied a remedy in a court of equity. The remaining grounds of demurrer are, in substance, to the effect that it is necessary and indispensable to the maintenance of this suit, first, that Mrs. Bastian and her husband should be parties; second, that the personal representative of Edgar Jamison should be a party; and, third, that Thomas J. Craven, executor and trustee, should be a party, but cannot be made such, this court not having jurisdiction over him and he residing in New Jersey “not being capable of being brought into court.” It will be convenient to take up these three points in their reverse order. Persons legitimately made parties to suits in equity may belong to three classes: First, proper parties, second, necessary parties, and, third, indispensable parties. The phrases proper parties, necessary parties and indispensable parties, in their technical sense, are distinguishable from one another, each denoting a separate and independent class. But in a broader sense the first is the most and the last the least comprehensive class; for proper parties may or may not be either necessary or indispensable, and necessary parties may or may not be indispensable. In the same broad sense an indispensable party is both a necessary and a proper party, and, though a necessary party may or may not be indispensable, he is nevertheless a proper party. The distinction between a necessary and an indispensable party, while doing violence to the English language in its usual acceptation, has been recognized for the purpose of determining the question whether some of those who under the well-established rules of equity pleading and practice were deemed necessary parties, may not, under existing rules governing pleading and practice in equity, be dispensed with as parties in order that equitable relief in a given case may not wholly fail. Equity rule 47, promulgated by the Supreme Court, is as follows:

“In all cases where it shall appear to the court that persons, who might otherwise be deemed necessary or proper parties to the suit, cannot be made parties by reason of their being out of the jurisdiction of the court, or incapable otherwise of being made parties, or because their joinder would oust the jurisdiction of the court as to the parties before the court, the court may

in their discretion proceed in the cause without making such persons parties; and in such cases the decree shall be without prejudice to the rights of the absent parties."

This rule confers discretionary power on the court in the cases specified to dispense with the presence of persons who otherwise would be deemed necessary or proper parties, to the end that justice may not be defeated. But it does not, and in reason could not, apply to those whose presence as parties is essential to the granting of the relief sought and whose absence would render impossible or nugatory any decree for such relief. Nor is there anything in section 8 of the act of March 3, 1875 (18 Stat. 472, c. 137), relating to the jurisdiction of the Circuit Courts of the United States, as amended by Act March 3, 1887, c. 373, 24 Stat. 552, and Act Aug. 13, 1888, c. 866, 25 Stat. 433 (U. S. Comp. St. 1901, p. 513), to countenance the idea that an indispensable party may be dispensed with in the suits therein referred to. That section provides, among other things, that, when in any suit commenced in a Circuit Court to enforce a legal or equitable lien on real estate within the district where such suit is brought "one or more of the defendants therein shall not be an inhabitant of, or found within, the said district, or shall not voluntarily appear thereto, it shall be lawful for the court to make an order directing such absent defendant or defendants to appear, plead, answer or demur, by a day certain to be designated," which order shall, if practicable, be served on such defendant or defendants wherever found, but, if not practicable, shall be published as in the section provided; and, in case of the failure of such defendant or defendants to appear, plead, answer or demur, as ordered, the court may "entertain jurisdiction, and proceed to the hearing and adjudication of such suit in the same manner as if such absent defendant had been served with process within the said district." In conferring power on the court, in case of such failure by a defendant after service or publication of such order, to hear and determine the suit "in the same manner as if such absent defendant had been served with process within the said district," it must be assumed that Congress did not intend or contemplate the performance by the court of an impossibility, namely, the granting of relief in the absence of one whose presence as a party is indispensable to that end, but rather that the intention was that the court should, only if practicable, dispose of the suit in the same manner as if proper service of process had been made. A different interpretation of the provision would create an absurdity. On the question whether Craven as executor or trustee is an indispensable party in the case made by the bill there is little or no room for doubt. The portion of the estate of the testator to which it is claimed Mrs. Mathieson and Mrs. Bastian as children of Edgar Jamison are entitled in equal shares, is directed in the will to consist wholly of money invested in bonds and mortgages; and that portion is to be equal to the value of the portion devised and bequeathed to Clarence Jamison or Oliver V. Jamison. The amount of the portion, one half of which is claimed in the bill, was to be ascertained by adding to the value of the real estate devised to Clarence Jamison and Oliver V. Jamison the sum of \$4,000 and its interest,

charged upon the "Jamison Corner Farm" and the amount of the rest and residue of the testator's estate directed by him to be invested in bonds and mortgages, mentioned in the clause of the will in which provision is made for the valuation of the testator's real estate. The aggregate amount thus arrived at is directed in the will to be divided into three equal portions of which one, invested in bonds and mortgages, was to go after the death of Edgar Jamison to his children, and the other two to Clarence Jamison and Oliver V. Jamison respectively. In order to effectuate this purpose provision was made by the testator for raising out of or charging upon the real estate devised to Clarence and Oliver or adding to the value thereof, such sums as should be necessary to equalize the three portions. The bill alleges that all the debts and funeral expenses of the testator and all the legacies bequeathed by him were fully paid by Craven, the executor, save what was bequeathed to Edgar Jamison and his children. But it nowhere states the amount of the rest and residue to be invested in bonds and mortgages, as above mentioned, which was to enter into the computation and ascertainment of the portion to be shared equally by Mrs. Mathieson and Mrs. Bastian, nor does it aver that Craven as executor or as trustee under the will at any time passed or rendered any account or statement showing the amount of such rest and residue; and on the principle that pleadings are to be taken most strongly against the pleader it is not to be assumed that there was no such residue. It is alleged that the bill is filed "to enforce an equitable lien upon the said real property for such sums of money as may be found due and payable to the said Catherine P. Mathieson under and by virtue of the will of the said Thomas Jamison, deceased," and the bill prays among other things, that an account may be taken of what is due to her under the legacy or legacies devised as aforesaid, and that "the amount when so ascertained may be declared to be an equitable lien" upon the "Jamison Corner Farm," the "Capelle Farm" and the "Homestead Farm" in "the proportions as provided in the said will," and that "Thomas J. Craven, trustee, be ordered and directed to raise out of each of the said tracts or parcels of land the sum ascertained to be due said Catherine P. Mathieson and charged respectively upon the said several tracts or parcels of land, or that a trustee be appointed and directed to so raise said amounts due said Catherine P. Mathieson out of the said lands by sale, mortgage or otherwise, as the court may direct, within three months." If the share of Mrs. Mathieson were ascertained in amount, and it also appeared in what parts or proportions it is to be raised from the several tracts of land respectively, it might be that this court would have power in the absence of Craven to decree a sale by a master or trustee of its own appointment to satisfy such share. But before any lien on real estate in favor of Mrs. Mathieson can be enforced it is necessary to determine its amount. It is also evident that the owners of the land devised to Clarence Jamison and Oliver V. Jamison are directly interested in the ascertainment of the amount of the "rest and residue"; for the sums chargeable against such lands will be less, if such amount be greater, and greater if such amount be less. It is a necessary condition to the granting of the relief sought

that there should have been or should be an accounting by the executor or other person having the execution of the will of Thomas Jamison, showing the amount of such residue, and Craven as executor, if not as trustee, is therefore, under existing facts, an indispensable party, without whose presence this suit must either fail or be held in abeyance. But the ground of demurrer that Craven, being an indispensable party, cannot be brought into court is untenable. Both as trustee and as executor he has been named in the bill as a party defendant, process is prayed against him, and non constat but that although a nonresident of Delaware he will voluntarily appear or service of process may be made on him. However vital his presence in this court hereafter may be, the fact that being an indispensable party he is a nonresident is no legitimate ground of demurrer.

The ground of demurrer next to be considered is that the personal representative of Edgar Jamison has not been made a party. The will of Thomas Jamison provides:

"The share of the said Edgar shall be in money invested in good bonds and mortgages as aforesaid, the interest payable to him, after such apportionment semi-annually during his natural life and from and immediately after his death the principal and all interest accrued thereon payable to his child or children or the issue of such."

The interest last mentioned in the above clause, when considered as a whole, must to avoid repugnancy be held to mean interest accruing on the principal fund after the death of the life beneficiary, and not forming part of his estate. Further, it is to be observed that it does not appear from the bill that the contemplated apportionment was made during the lifetime of Edgar Jamison or at any time since. In so far as the relief sought in this suit involves the principal fund last referred to or its interest, no claim is made by Mrs. Mathieson against the estate of her father but solely under the will of Thomas Jamison. The will further provides, as before stated, in substance, that the "Jamison Corner Farm," on the death of Albert Jamison without leaving issue should go to his brothers, Edgar, Clarence and Oliver V. Jamison "and their issue, the heirs and assigns of such issue, subject to the same conditions and limitations as their own shares are respectively subject to under this will." It is not necessary at this stage of the case to decide or consider what effect, if any, the death of Albert Jamison during the lifetime of the testator had upon the devolution or disposition to be made of the "Jamison Corner Farm." Whether that farm passed to Edgar, Clarence and Oliver V. Jamison, and their issue, under the will, or, subject to the \$4,000 charge, descended in fee to all the children of Thomas Jamison, or constituted a part of the "rest and residue" of the testator's estate which was to enter into the share of Edgar Jamison, are questions the solution of which can in no way require the presence of the personal representative of Edgar Jamison as an indispensable or necessary party. If the farm passed under the will to the testator's sons and their issue, or formed a portion of the rest and residue which, under the will, was to enter into Edgar's share, Mrs. Mathieson does not claim as legatee or distributee of the estate of her father, but solely under the will of her grandfather, Thomas Jamison; and the personal representative of her father's estate would

not be an indispensable, necessary or even proper party to the suit. So, if the farm, subject to the \$4,000 charge, descended in fee to all the children of Thomas Jamison, his will, save as to that charge, was wholly inoperative upon it, and, while the raising of the \$4,000 might be enforced in this suit as a charge created by him paramount to any claim against the farm created or suffered by any persons after his death, no claim, aside from the charge of \$4,000, could successfully be asserted in this suit against such farm; and thus, on the last assumption also, the presence of the personal representative of Edgar Jamison as a party is neither indispensable nor necessary. The circumstance, if it be a fact, that the "Jamison Corner Farm" descended, subject to the \$4,000 charge, to the children of Thomas Jamison, while preventing the granting of the full measure of relief prayed, cannot defeat this suit in so far as it involves property of the testator other than that farm. The demurrer is to the whole bill, and cannot be sustained if on the face of the bill it appears that the complainant is entitled to any of the relief prayed. The second ground of demurrer must, therefore, be overruled.

The remaining ground of demurrer is, in substance, that it is indispensable to the maintenance of this suit that Mrs. Bastian and her husband should be parties. It appears from the amended bill that Mrs. Bastian, as one of the children of Edgar Jamison, is entitled, if entitled at all, to precisely the same measure and kind of relief as Mrs. Mathieson. The claims of Mrs. Mathieson and Mrs. Bastian do not in any sense constitute a joint demand on their part against the estate of Thomas Jamison, but are clearly separable from each other. The reasons urged in support of the ground of demurrer now under consideration are substantially as follows: (1) That the place of residence and citizenship of Mrs. Bastian does not appear and no excuse is shown for omitting her as a party; (2) that in order to ascertain what is due to Mrs. Mathieson an account must be taken of what is due to both her and Mrs. Bastian, as the former, if entitled to anything, has a claim to just one half of what is coming to both; (3) that Mrs. Bastian should be a party to any account that may be taken at the instance of Mrs. Mathieson in order that the defendants may be secured thereafter from being compelled by Mrs. Bastian to account for what may be due to her; and (4) that should a sale of the real estate be effected under a decree of this court rendered in the absence of Mrs. Bastian the purchaser would acquire the land subject to her lien claim, unascertained in amount, which would constitute a cloud upon the title. The first reason contains an unwarranted assumption; for it appears from the amended bill that Mrs. Bastian and her husband are citizens of Pennsylvania, which fact furnishes sufficient excuse for omitting them from the bill to avoid defeating the jurisdiction of this court over this suit. The second and third reasons may be considered together. It is true that the ascertainment of what is due to Mrs. Mathieson involves primarily an ascertainment of what is due to both Mrs. Bastian and Mrs. Mathieson; and it is also true that, other things being equal, Mrs. Bastian should be a party in order that the defendants should not be compelled to account to her separately from Mrs. Bastian. But these considerations do not of themselves show that Mrs. Bastian

is an indispensable party, whatever may be said of her as a necessary party. *Payne v. Hook*, 7 Wall. 425, 19 L. Ed. 260; *Horn v. Lockhart*, 17 Wall. 570, 21 L. Ed. 657; *Hotel Co. v. Wade*, 97 U. S. 13, 21, 24 L. Ed. 917; *West v. Randall*, Fed. Cas. No. 17,424; *Wood v. Dummer*, Fed. Cas. No. 17,944. In *Payne v. Hook*, supra, it was held that in a suit by one distributee of an intestate's estate against the administrator it was not indispensable that the other distributees be made parties, if the court could do justice to the parties before it without injury to absent parties equally interested. The court through Mr. Justice Davis said:

"But it is said the proper parties for a decree are not before the court, as the bill shows there are other distributees besides the complainant. It is undoubtedly true that all persons materially interested in the subject-matter of the suit should be made parties to it; but this rule, like all general rules, being founded in convenience, will yield whenever it is necessary that it should yield in order to accomplish the ends of justice. It will yield, if the court is able to proceed to a decree, and do justice to the parties before it, without injury to absent persons, equally interested in the litigation, but who cannot conveniently be made parties to the suit. The necessity for the relaxation of the rule is more especially apparent in the courts of the United States, where oftentimes, the enforcement of the rule would oust them of their jurisdiction, and deprive parties entitled to the interposition of a court of equity of any remedy whatever. * * * It can never be indispensable to make defendants of those against whom nothing is alleged and from whom no relief is asked. A court of equity adapts its decrees to the necessities of each case, and should the present suit terminate in a decree against the defendants, it is easy to do substantial justice to all the parties in interest and prevent a multiplicity of suits by allowing the other distributees, either through a reference to a master, or by some other proper proceeding, to come in and share in the benefit of the litigation."

In *Hotel Co. v. Wade*, supra, the court through Mr. Justice Clifford said:

"It is true, beyond doubt, that all persons materially interested in the fund to be distributed should be made parties to the litigation; but this rule, like all general rules, will yield whenever it becomes necessary that it should be modified in order to accomplish the ends of justice. Authorities everywhere agree that exceptions exist to the general rule; and this court decided that the general rule will yield if the court is able to proceed to a decree and do justice to the parties before the court, without injury to others not made parties, who are equally interested in the litigation. *Payne v. Hook*, 7 Wall. 425, 19 L. Ed. 260. Examples of the kind are put by Judge Story, in his work on Equity Pleading. Speaking of a bill brought by one of several residuary legatees for a final settlement and distribution of the estate of the testator or intestate, he says, all the residuary legatees or distributees ought in general be made parties; but he admits that, if some are out of the jurisdiction of the court and cannot conveniently be joined, the court will dispense with them, and proceed to decree the shares of those before the court, the rule being that the decree is conclusive only as to those who are parties to the litigation. Story, Eq. Pl. § 89; *West v. Randall*, 2 Mason, 193, Fed. Cas. No. 17,424; *Wood v. Dummer*, 3 Mason, 308, Fed. Cas. No. 17,944. Parties who are not named may intervene and make themselves actual parties, so long as the proceedings are in fieri and are not definitely closed by the course and practice of the court. *Campbell and Others v. Railroad Co.*, 1 Woods, 369, Fed. Cas. No. 2,366."

In *Williams v. Crabb*, 117 Fed. 193, 54 C. C. A. 213, 59 L. R. A. 425, the Circuit Court of Appeals for the Seventh Circuit held that where one of the two heirs at law of a decedent had brought suit to set aside a will and a deed executed by the decedent for fraud and

undue influence, and to recover the complainant's share of the property, the other heir was not an indispensable party, as his joinder would have ousted the jurisdiction of the court. The court through Bunn, J., among other things, said:

"Nor can the objection prevail that Helen Alexander is not made a party defendant or a party complainant with her brother, having an equal interest in the estate of her sister with the complainant. She is not an indispensable party. * * * Nobody will be bound by any decree except the parties thereto. Without being joined as complainant, and without bringing suit on her own behalf, Helen Alexander's interest in the estate cannot be affected by a decree in favor of this complainant. The defendant Crabb cannot justly complain that the suit is not brought to recover the entire estate of Ellen Williams, rather than a one-half interest. The utmost consequence that could follow would be that the defendants might be subjected to another suit by Helen Alexander, but that would be no hardship compared with turning the complainant out of court, who would now, no doubt, be barred, under the statute, from commencing another action so far as the will is concerned."

As before stated, the claims of Mrs. Mathieson and Mrs. Bastian are separable in their nature and, while it might be more convenient, if the principles of jurisdiction permitted, that both should join as complainants in this suit in order to avoid a separate accounting in favor of Mrs. Bastian, the latter, nevertheless, is not indispensable to the suit as a party, and the former should not be denied redress in this court to which she may otherwise be entitled for the sake of relieving the defendant executor or trustee from subsequently and separately accounting to Mrs. Bastian. To the fourth reason, urged in support of the alleged indispensability of Mrs. Bastian as a party, to the effect that the purchaser of the real estate sold by direction of this court in her absence would acquire such real estate subject to a lien in her favor unascertained in amount and constituting a cloud on the title, the considerations applicable to the second and third reasons have pertinency. It is proper, also, to add that certain questions may or may not arise in this suit or certain proceedings hereafter be resorted to therein, the solution or effect of which may or may not tend to obviate the trouble to which it has been suggested the executor, trustee or purchaser may be put, if the bill in its present shape be maintained. It appears that Mrs. Bastian "consents to the relief sought in this bill and to all proceedings had and to all orders or decrees made or that may be made by the court in this cause," and further, that Mrs. Bastian originally joined as a co-complainant in this case to recover the separable claim made by her. Under these circumstances it is possible, if not probable, that she may apply so to intervene in the suit as to result in a sale of the real estate discharged from any lien in her favor and free from cloud or encumbrance on the title. Whether such intervention be permissible it would be premature to decide now. Or it may or may not be that under the circumstances the court may effect a sale of the real estate clear of the liens claimed by Mrs. Bastian and Mrs. Mathieson, or either of them, without a formal intervention by Mrs. Bastian. It would be unnecessary and improper to decide this point now. These questions and others which may be presented may more satisfactorily be passed on hereafter. It would be

imprudent to the last degree in deciding this demurrer to express an opinion on them.

It is also suggested rather than urged in support of the demurrer that Mrs. Bastian was dropped as a party from this suit by collusion with Mrs. Mathieson in order to confer jurisdiction. The court fails to perceive any justification for this suggestion. Mrs. Mathieson certainly had a right to sue in this court for the relief sought by her. It is equally certain that Mrs. Bastian did not have a right to sue as co-complainant for the relief sought by her, as jurisdiction would thereby be ousted. Mrs. Bastian, therefore, was dropped as a party and Mrs. Mathieson and her husband alone proceed for what she claims she is entitled to. The charge that it appears that Mrs. Mathieson was a party to any collusion obnoxious to the law or inconsistent with the principles of equity is wholly unfounded. On the whole I am satisfied that the demurrer should be overruled and the defendants required to plead or answer by the first Monday in July next, and it is so ordered, adjudged and decreed.

In re PITTSBURG DRUG CO.

(District Court, W. D. Pennsylvania. February 28, 1908.)

1. BANKRUPTCY (§ 350*) — DEBTS ENTITLED TO PRIORITY—CLAIM OF LANDLORD FOR RENT.

Under Bankr. Act July 1, 1898, c. 541, § 64b (5) 30 Stat. 563 (U. S. Comp. St. 1901, p. 3448), which gives priority to debts which are entitled to priority under the laws of the state, and Act Pa. June 16, 1836 (P. L. 777) § 83, which gives a landlord a lien on goods on the demised premises and liable to distress for the rent due at the time of the taking of such goods in execution, not to exceed one year's rent, upon the bankruptcy of a lessee under a lease giving the lessor the right of distress as to all goods on the premises, and also providing that on default in the payment of any rent the rent for the entire term should at once become due and payable, where at the time of the bankruptcy the lessee was in default, the landlord is entitled to priority for one year's rent from the proceeds of the property subject to distress, although he had made no levy thereon but had notified a receiver appointed by a state court for the lessee of his claim.

[Ed. Note.—For other cases, see Bankruptcy, Dec. Dig. § 350.*]

2. BANKRUPTCY (§ 318*) — PROVABLE DEBTS—CLAIM OF LANDLORD FOR RENT—“FIXED LIABILITY ABSOLUTELY OWING.”

Where a lease provided that on default in the payment of any rent the rent for the entire term should at once become due and payable, on the bankruptcy of the lessee while so in default the rent for the term, so far as definitely fixed by the lease, is a “fixed liability absolutely owing,” within the meaning of Bankr. Act July 1, 1898, c. 541, § 63a (1), 30 Stat. 562 (U. S. Comp. St. 1901, p. 3447), and provable in bankruptcy against the lessee's estate; but taxes and insurance premiums which the bankrupt covenanted to pay as a part of the rent, but which at the time of the bankruptcy were not due, nor the amount then capable of ascertainment, are not so provable.

[Ed. Note.—For other cases, see Bankruptcy, Dec. Dig. § 318.*]

In Bankruptcy. On certificate from referee.

*For other cases see same topic & § NUMBER in Dec. & Am. Digs. 1907 to date, & Rep'r Indexes

C. A. Woods, for claimant.
W. A. Way, for trustee.

YOUNG, District Judge. This case comes before us upon the certificate of the referee in bankruptcy awarding to D. E. Nevin, landlord of the bankrupt, a priority in the sum of \$11,458.40, and an unsecured claim in the sum of \$13,722.71, for rent of the premises where the bankrupt carried on its business. Exceptions were filed to the report and order of the referee, by the trustee in bankruptcy, to the allowance of the priority and to the unsecured claim. The landlord also filed exceptions to the report and order, alleging that the referee erred in not allowing as a priority the further sum of \$1,962.64, an amount equal to the city taxes for 1907; the sum of \$201.59, an amount equal to the city water rent for the year 1907; the sum of \$363.51, an amount equal to the county taxes for 1907; and the sum of \$1,440, an amount equal to the fire insurance premiums due November 27, 1907.

Statement of Facts.

The bankrupt, upon the 17th day of May, 1906, by lease in writing, rented from Daniel E. Nevin certain premises at the corner of Wood street and First avenue, in the city of Pittsburg, for the term of two years, from the 1st day of May, 1906, to the 30th day of April, 1908 for the total rent of \$27,500, payable in monthly installments of \$1,145.84. The lease also provided for the payment of certain sums in addition to the rent, that provision being as follows:

"In addition to the rent above specified, lessee agrees and covenants to pay said lessor as an additional rent the following sums, viz.: On or before March 30, 1907, a sum equal to amount of city taxes assessed against said premises, March and September installment for 1907; likewise on or before June 30, 1907, a sum equal to the city water rent assessed against said premises for 1907; likewise on or before July 30, 1907, a sum equal to the Allegheny county taxes assessed against said premises for 1907, provided that for the year 1907, if on or before the above respective dates lessee pays or causes to be paid the taxes, delivering the lessor the official receipts therefor, credit shall be given said lessee for said respective sums on account of this lease; also on or before March 30, 1908, lessee shall pay lessor a sum equal to one-third of all taxes assessed against said premises for 1908, city, water, and county. Lessee also covenants and agrees to pay lessor as additional rent a sum or sums sufficient to pay all premiums of fire insurance in approved companies from the date of this lease to April 30, 1908, to the amount of \$60,000 required by the first mortgage, and \$20,000 required by the second mortgage now on said premises; and in the event of the cancellation of any or all of the policies and the refusal or neglect of the lessee to pay said premiums, or pay the amounts, or any of them, above specified, required to pay taxes where and as specified, lessor at his option may cancel this lease, or proceed and collect any and all said same as additional rent, in the same manner as provided in this lease, by landlord's warrant, confession of judgment, or otherwise."

The lease also contains the following provision:

"And it is further agreed that in case default be made at any time in the payment of any installment of rent, or of the water tax, or of any other sum which may become due by the terms and conditions of this lease, or should the said lessee at any time remove or attempt to remove any of the goods and chattels from the premises without having paid the entire rent and water rent and other items above referred to, or should an execution be issued against

lessee, bankruptcy proceedings be begun by or against said lessee, or an assignment be made for benefit of creditors, or a receiver appointed, the entire balance of the term of the lease, including water tax or other sum, etc., then unpaid, shall thereupon become due and payable, and a landlord's warrant may be issued forthwith on this lease, and prosecuted to levy and sale for the collection of the same."

The facts as agreed upon before the referee were:

(1) That defaults were made by the lessee in the payment of rent under said lease due September 1, October 1, and November 1, 1906, and that on November 23, 1906, in the court of common pleas No. 2 of Allegheny county in *Seamless Rubber Company v. Pittsburg Drug Company*, at No. ———, January term, 1907, on bill in equity filed, C. F. Patterson was appointed receiver of the Pittsburg Drug Company, and thereafter on November 26, 1906, at the above number, an involuntary petition in bankruptcy was filed against the Pittsburg Drug Company; the act of bankruptcy in said involuntary petition being the above-stated appointment of a receiver by the common pleas court.

(2) That after the appointment of the receiver in the common pleas court, and prior to the filing of the bankruptcy petition, counsel for the said landlord stated to the receiver in the common pleas court that the landlord proposed to claim one year's rent as a priority claim and the rent for the balance of the term as an unsecured creditor, and thereafter, upon the filing of the bankruptcy petition and the appointment of the said Charles F. Patterson as receiver in the bankruptcy court, renewed and reiterated said statement to him as receiver in the bankruptcy court.

(3) The said receiver took possession of the personal property on the premises described in said lease and the same was thereafter sold by Justus Mulert, trustee in bankruptcy, on March 16, 1907, to J. M. Young, for the sum of \$31,350; the goods so sold having been goods that were on the premises and subject to distress at the time the receiver was appointed in the common pleas court and in the bankruptcy court.

(4) The city of Pittsburg taxes March and September installments, 1907, and the water rent for 1907, and the county taxes for 1907, specified in Exhibit B attached to the landlord's claim, were ascertained and assessed in February, 1907.

(5) The landlord became liable for the fire insurance premiums on November 27, 1906 appearing upon Exhibit B attached to landlord's claim, in amount of \$1,440, and actually paid the same on December 4, 1906; these insurance premiums being for insurance on the premises according to terms of the lease in advance for one year from November 27, 1906.

(6) On the 22d of April, 1907, the trustee notified the landlord that he would cease to occupy the premises after the end of April, 1907, and offered to surrender the premises. On the 25th of April, 1907, the landlord refused to accept the surrender of the premises.

(7) Prior to the 1st of May, 1907, the trustee, in pursuance of the foregoing notice to the landlord, vacated and abandoned the premises, and since May 1, 1907 has occupied them in no way whatever, and the

landlord has refused to accept said surrender of the premises or to retake possession of the same in any way.

(8) It is further agreed upon as a fact, if deemed material by the court, that the premises are now occupied by J. M. Young, above named, without permission, or without any contract of lease, contract, or agreement of any nature whatsoever with the said landlord; but the said J. M. Young stands ready and willing to pay \$200 a month rental to whichever party will receive the same, but both of said parties have refused to consider any negotiations or offers whatsoever from the said J. M. Young.

The landlord, alleging a default, filed a proof of claim for the sum of \$25,181.11, claiming priority for the sum of \$15,426.14, and the balance \$9,754.97 as an unsecured claim.

Out of the above facts arises the question: Is the landlord entitled to a priority for a part of his claim and an unsecured claim for the balance? This question naturally falls into two inquiries: First, is the landlord entitled to priority, no warrant of distress having been issued? and, second, to what amount is the landlord entitled to priority? The landlord's claim to priority, if allowed, must be based upon the provisions of the bankrupt act of 1898 (Act July 1, 1898, c. 541, § 64b [5], 30 Stat. 563 [U. S. Comp. St. 1901, p. 3448]) which provides that the debts to have priority shall be, among others:

"Debts owing to any person who by the laws of the state or the United States is entitled to priority."

The question then arises: Is the landlord's claim for rent such a debt as under the laws of the state of Pennsylvania would be entitled to priority? Act June 16, 1836 (P. L. 777) § 83, of the commonwealth of Pennsylvania, provides:

"The goods or chattels being in or upon any messuage, lands or tenements which are or shall be demised for life or years or otherwise, taken by virtue of an execution and liable to the distress of the landlord, shall be liable for the payment of any sums of money due for rent at the time of taking such goods in execution: Provided that such rent shall not exceed one year's rent."

While the statute allows the landlord one year's rent where the goods liable to distress are taken in execution, it was decided in *Longstreth v. Pennock*, 87 U. S. 575, 22 L. Ed. 451, that where the goods are taken by an assignee in bankruptcy the claim of the landlord to a year's rent is within the equity of the statute which gives a preference in case of execution. It would appear, then, that the bankrupt act having given a priority to any person who under the laws of the state would be entitled to a priority, and the statute of Pennsylvania having entitled the landlord to one year's rent out of the proceeds of the sale of goods on the premises liable to distress, the landlord is such person as is provided by the section of the bankrupt act referred to, and the debt such an one as is entitled to priority.

It was argued that the case of *York Manufacturing Co. v. Cassell*, 201 U. S. 344, 26 Sup. Ct. 481, 50 L. Ed. 782, 15 Am. Bankr. Rep. 633, which decided that the trustee in bankruptcy was vested with no better right or title to the bankrupt's property than belonged to the

bankrupt, following *Thompson v. Fairbanks*, 196 U. S. 516, 25 Sup. Ct. 306, 49 L. Ed. 574, 13 Am. Bankr. Rep. 437, where the court said:

"Under the present bankrupt act the trustee takes the property of the bankrupt, in cases unaffected by fraud, in the same plight and condition that the bankrupt himself held it, and subject to all the equities impressed upon it in the hands of the bankrupt, except in cases where there has been a conveyance or incumbrance of the property which is void as against the trustee by some positive provision of the act"

—qualified the doctrine of *Longstreth v. Pennock*, *supra*. We are of opinion that those decisions do not qualify the doctrine of that case, but rather emphasize the right of the landlord to claim his rent; all the goods on the premises being under the terms of the lease subject to distress for the entire rent of the term. So that the trustee, standing in the shoes of the bankrupt, took the goods subject to the landlord's right of distress; that right being limited by the act of 1836 to an amount not exceeding one year's rent, and it having been admitted in this case that the goods taken by the trustee were on the premises, liable to distress, and were sold for more than sufficient to pay the rent for the entire term. It has been uniformly held in Pennsylvania, not only under the act of 1836, but under the original act of 1772 (1 Smith's Laws, p. 371), and down through all the cases to the present time, that in case of execution the landlord was entitled to one year's rent due at the time of the seizure of the goods.

It was argued in this case that the claim of priority could not be allowed, because there was no distress prior to the bankruptcy petition. We do not regard this as tenable. The landlord had the right of distress. The goods were subject to distress. The statute itself provides that the landlord shall have this right if the goods are liable to distress. In *Moss' Appeal*, 35 Pa. 162, Mr. Justice Woodward said:

"Undoubtedly the landlord cannot claim the proceeds of goods that he could not have distrained; but what right have we to say, in the face of the statute, that he may not claim the proceeds of goods that were liable to his distress? No reasoning that we have met in reported cases would seem to justify so narrow a construction of a remedial statute."

This is recognized in *Re Gerson* (D. C.) 2 Am. Bankr. Rep. 170. We must conclude, therefore, that if the goods were on the premises and liable to distress the landlord would be entitled to his claim, though the goods had not been taken by warrant of distress.

We now come to the second inquiry, and that is, to what amount is the landlord entitled to priority? While the statute gives the landlord one year's rent, he is only entitled to this rent if it was due at the time of the seizure of the goods under the execution. We must therefore determine what amount of rent was due at the time of the filing of the bankruptcy petition, November 26, 1906. It appears from the landlord's proof of claim that at that time there was past due rent for the month of September to the amount of \$291.68, rent for the month of October, \$1,145.84, and rent for the month of November, payable in advance, \$1,145.84. But there is claimed by the landlord, and awarded by the referee, rent from September 1, 1906, to September 1, 1907. This claim of the landlord is based upon the covenant in the lease that if default be made in the payment of rent, or if, among

other things, a receiver be appointed, the rent for the entire term should become due and payable; and it is claimed that *Platt v. Johnson*, 168 Pa. 47, 31 Atl. 935, 47 Am. St. Rep. 877, is authority for the claim. It is there said:

"As was said in *Goodwin v. Sharkey*, 80 Pa. 149, 'the whole rent for the term might have been made payable at any time during the running of the lease, upon the happening of any contingency. The right of distress would immediately arise,' upon the happening of the specified contingency; and that right might be exercised by the lessor to the extent of collecting more than one year's past due rent, provided the rights of execution creditors have not previously attached. If they have, the act of June 13, 1836, limiting the lessor's right to payment out of such fund to amount not exceeding one year's rent, becomes operative in favor of the execution creditors."

This is the law of Pennsylvania; but it at once gives rise to the inquiry whether parties, by contract or by covenant in their lease, can avoid the provision of the bankrupt law which requires "a fixed liability as evidenced by a judgment or an instrument in writing absolutely owing at the time of the filing of the petition against him, whether then payable or not," as provided by section 63a (1) of the bankrupt act. It appears to have been decided in many cases by different judges of the District Courts that rent which would fall due after the filing of the petition in bankruptcy will not be provable, although the covenant of the lease provides that it shall become due. In our own circuit, in the case of *Wilson v. Pennsylvania Trust Co.*, 8 Am. Bankr. Rep. 169, 114 Fed. 742, 52 C. C. A. 374, it was said by Judge Acheson:

"Notwithstanding the ruling in *Platt v. Johnson*, 168 Pa. 47, 31 Atl. 935, 47 Am. St. Rep. 877, upholding as valid a provision in a lease that the entire rent for the balance of the term should become due if the lessee should become embarrassed, or make an assignment for the benefit of creditors, or be sold out by sheriff's sale, it may well be doubted whether the stipulation here making the whole rent for the whole term due and payable if the lessee shall become a bankrupt is enforceable as against the provisions of the bankrupt act."

The question, however, was not decided, as the case went off on another question. So far as we have been able to find, the question has not been decided by an appellate court. It is an important question, and one of special importance in this case, because of the large amount involved. Notwithstanding the eminent authority cited by counsel for the trustee, and especially the case of *Wilson v. Pennsylvania Trust Co.*, supra, we are of opinion that the covenant in the lease making the rent for the entire term fall due is good, and the debt thereby created one provable in bankruptcy. In the cases cited, and especially in *Wilson v. Pennsylvania Trust Co.*, supra, the default provided for was the event of the tenant becoming a bankrupt. In the case at bar the default relied upon is provided by the following clause of the lease:

"And it is further agreed that in case default be made at any time in the payment of any installment of rent, or of the water tax, or of any other sum which may become due by the terms and conditions of this lease, or should the lessee at any time remove or attempt to remove any of the goods and chattels from the premises without having paid the entire rent and water rent and other items above referred to, or should an execution be issued against lessee, bankruptcy proceedings be begun by or against said lessee, or an assignment be made for benefit of creditors, or a receiver appointed, the

entire balance of the term of the lease, including water tax or other sum, etc., then unpaid, shall thereupon become due and payable, and a landlord's warrant may be issued forthwith on this lease, and prosecuted to levy and sale for the collection of the same."

It is admitted that part of September rent and all of October and November rent for 1906 was past due, and that a receiver had been appointed by the state court on November 23, 1906, and that that receiver had been notified that the landlord would claim a year's rent as priority and the balance as an unsecured claim, and all before the filing of the bankruptcy petition. So that it appears by the express terms of the contract the entire rent for the term had become due, had become "a fixed liability absolutely owing at the time of the filing of the petition," and a landlord's warrant could have been issued for the collection of the entire amount. It also appears to us to be just as much a fixed liability, evidenced by an instrument in writing, absolutely owing at the time of the filing of the petition, as a bond securing the payment of an annuity (*Cobb v. Overman*, 6 Am. Bankr. Rep. 324, 109 Fed. 65; 48 C. C. A. 223, 54 L. R. A. 369), or a bond of an administrator (*Hibbard v. Bailey*, 12 Am. Bankr. Rep. 104, 129 Fed. 575, 64 C. C. A. 143), which by its provisions would fall due upon a default being made. In its favor we have the weight of authority of the case of *Platt v. Johnson*, *supra*. We are therefore of opinion that, not only is the debt one provable in bankruptcy, but that the whole amount became due under the express covenants of the lease and limited by the act of 1836, allowing a priority to the landlord to an amount not exceeding one year's rent, the remainder to be proved as an unsecured debt.

A question also arises as to the taxes, which under the terms of the lease are made payable at certain times after the filing of the bankruptcy petition, namely, March 30, June 30, and July 30, 1907, and the premiums of insurance, payable November 27, 1906, also after the filing of the bankruptcy petition. There is an express covenant in the lease that these taxes should be paid as additional rent on or before the dates specified. These taxes and the water rent were therefore made additional rent by the lease, and under the express covenants of the lease would be added to the monthly rents for the months of March, June, and July, 1907, and would become due upon the default in the payment of any of the installments of rent, or upon the appointment of a receiver or other contingency provided by the lease, and could have been collected when those dates arrived as rent for those months, and, if a bankruptcy petition had not been filed until after those several dates arrived, they would have become due and collectible under the express terms of the lease in case of default; but the bankruptcy petition was filed on November 26, 1906, and before the amount of taxes could be determined, because those taxes could not be determined until the municipal authorities, city and county, had fixed the rate and made the tax levy. They were not liquidated, and could not be liquidated until after the proper municipal action had been taken. How can it, then, be said that they became due by the default? What amount became due? Certainly not the amount now

claimed, for that amount was not fixed and determined until after the filing of the petition, namely, by the tax levy in February, 1907. The taxes, therefore were not a fixed liability at the time of the filing of the petition, and would not be provable in bankruptcy as between the landlord and his tenant, and necessarily could not be allowed as a priority. The same is true as to the insurance premiums, which it is admitted the landlord did not become liable for until November 27, 1906, the day after the petition in bankruptcy was filed. The premiums of insurance, therefore, cannot be allowed as a priority.

The taxes and premiums of insurance not being a fixed liability within the meaning of section 63a (1) of the bankrupt act are not provable as unsecured claims, as we have above concluded. Nor are they such unliquidated claims against the bankrupt as can be proved under section 63b, our understanding of that section being that it admits to proof only those claims which can be liquidated by legal proceedings instituted at the time of the bankruptcy; and this claim, as we have seen, could only be liquidated by the proper municipal action fixing the rate of taxation and the amount of the tax levy.

We find, therefore, that the landlord is entitled to priority for one year's rent, less the payments that have been made to him, as found by the referee, and to prove the remainder of the rent for the term as an unsecured claim; that he is not entitled to the taxes and insurance premiums as claimed by him and is not entitled to prove them as an unsecured claim. As thus modified, the report of the referee is affirmed, and all exceptions either sustained or rejected in accordance with this opinion.

In re ADAMS & HOYT CO.

(District Court, N. D. Georgia. October 21, 1908.)

No. 2,235.

BANKRUPTCY (§ 71*)—CORPORATIONS—EFFECT OF PROCEEDINGS FOR DISSOLUTION.

Where a corporation, being insolvent, commits acts of bankruptcy by preferring certain creditors, the jurisdiction of a court of bankruptcy to adjudicate it a bankrupt and administer its estate under the provisions of the bankruptcy act (Act July 1, 1898, c. 541, 30 Stat. 544 [U. S. Comp. St. 1901, p. 3418]) attaches, and the corporation cannot avoid such jurisdiction and validate its preferences by instituting proceedings for dissolution in a state court before bankruptcy proceedings against it are instituted.

[Ed. Note.—For other cases, see Bankruptcy, Dec. Dig. § 71.*]

In Bankruptcy. On petition in involuntary bankruptcy.

Moore & Pomeroy, for petitioning creditors.

Candler, Thompson & Hirsch and Slaton & Phillips, for objecting creditors.

NEWMAN, District Judge. On August 5, 1908, the stockholders of the Adams & Hoyt Company filed a petition in the superior court of Fulton county, setting out that it was a corporation of Fulton

*For other cases see same topic & § NUMBER in Dec. & Am. Digs. 1907 to date, & Rep'r Indexes

county, Ga., authorized by its charter to do a general jobbing business in soda water apparatus, supplies, and the dispensing of soda—the petition further setting out the indebtedness of the corporation, and the statement of its assets, the latter being somewhat in excess of the former; that the capital of the company was inadequate to meet the demands of its business; that on the previous day, August 4th, there had been a meeting of its stockholders at which the outstanding capital stock thereof was represented, and a resolution was unanimously passed that the charter and franchises of the company be surrendered and further conduct of the business be abandoned; that the superior court be petitioned to take charge of the assets and administer them for the benefit of the creditors and stockholders; that, unless a court of equity should intervene, great loss would result to the stockholders and creditors, and it was necessary, therefore, that a receiver be appointed to liquidate the business under the direction of the court; that the company was not insolvent, but the assets of the company were in excess of the liabilities, and under proper management the company should be able to pay all creditors, and leave something for the stockholders. The petitioners then pray, first, that the court accept the surrender of the charter and franchises; second, that a receiver be appointed to take charge of all the assets of the company, and sell same at the best possible prices under the order of the court, and collect all indebtedness; third, that all the creditors be allowed to intervene, and that all persons be enjoined from interfering in any way with the assets or property in the hands of the receiver upon instituting suits on their claims or proceeding with suits already instituted.

Service was acknowledged on petition by the vice president and treasurer of the company. The judge of the superior court, upon presentation of the petition, passed an order, the material part of which is as follows:

“It appearing to the court that the said defendant corporation has been dissolved by the surrender of its charter, which surrender is hereby accepted by the court, and upon such surrender and dissolution all of its property and assets become a fund, first, for the payment of its debts, and then for equal distribution among its stockholders, and to this end this court has power to appoint a receiver under proper restrictions to properly administer said assets under its direction, all as provided in the Code of this state, and the defendant company consenting thereto, it is therefore considered, ordered, and adjudged that A. Cruickshank be and he is hereby appointed receiver of all the property and assets of every description belonging to the Adams & Hoyt Company,” etc.

This proceeding was instituted under sections 1884 and 1886 of the Code of Georgia of 1895. Later on the same day, August 5, 1908, certain creditors filed a petition in bankruptcy against the Adams & Hoyt Company in this court. Insolvency prior to the time of filing the petition in the state court was alleged, and certain acts of bankruptcy set out; several of them being payments to creditors within four months with the purpose, intent, and effect of preferring such creditors to whom payments were made over other creditors of the same class. Another act of bankruptcy alleged was that the Adams & Hoyt Company, while insolvent, and because of insolvency, au-

thorized, directed, and procured a petition to be filed in the superior court asking for the appointment of a receiver, and upon which a receiver was duly appointed by the judge of the superior court. The various grounds of bankruptcy were contained in the original petition, and an amendment subsequently filed.

Certain creditors came into the case by counsel and denied the jurisdiction of the court on the ground that the company had surrendered its charter and ceased to be a corporation by the proceedings in the superior court of Fulton county referred to above. The issue thus made was referred by the court to a special master, who has filed his report. This report, which goes thoroughly into the questions involved, is as follows:

"Petition for receiver having been filed in the state court on the 5th day of August, 1908, and one Cruickshank having been appointed receiver by the judge of the superior court, certain creditors on the 5th day of August, 1908, filed an involuntary petition in bankruptcy in the United States District Court; said petition alleging that the said Adams & Hoyt Company had committed acts of bankruptcy in making preferred payments while insolvent, and also having transferred and assigned to one Charles A. Bowen, for the purposes of hindering creditors of the company, in the sum of \$7,000. Subpoena was issued by the clerk, returnable the 15th day of August, and on that day a plea to the jurisdiction was filed by certain creditors of the Adams & Hoyt Company; the said pleadings stating that on the 5th day of August a bill had been filed in the superior court of Fulton county, and one Cruickshank had been appointed receiver of all the assets of the Adams & Hoyt Company, and an order had been duly passed, ordering and adjudging that the Adams & Hoyt Company should be dissolved, and that the charter was accepted by the Fulton superior court, and that by virtue of said order said corporation was now dissolved. Petitioners dispute that the Adams & Hoyt Company should be declared bankrupt for the reason that the Adams & Hoyt Company is not a corporation, and was not at the time of the filing of the petition in bankruptcy, and therefore comes not within the class of corporations which can be adjudicated bankrupts. In the answer filed on the same day petitioners deny that the Adams & Hoyt Company had within four months next preceding the date of filing of the petition, and while insolvent, committed an act of bankruptcy. Petitioners further deny that the Adams & Hoyt Company are insolvent. Under an order passed by the judge of the District Court on August 21, 1908, all the questions of fact and law involved in the above pleadings are referred to me as special master, to report my findings to the court at as early a date as possible.

"On the 2d day of September, 1908, at the first hearing of these proceedings, an amendment was filed by the petitioners in bankruptcy; said amendment alleging a transfer to the Fourth National Bank, one of the creditors of the Adams & Hoyt Company, on the 7th day of July, 1908, with intent to prefer, etc. The amendment further charges that the Adams & Hoyt Company had authorized, directed, and procured the petition to be filed in the superior court of Fulton county, asking the appointment of a receiver; that under the petition the receiver was appointed by the judge of the superior court; that the Adams & Hoyt Company had, on the 21st day of July, 1908, paid to the West India Manufacturing Company \$58, with intent to prefer said creditor, etc.

"I find from the evidence the following facts: That the Adams & Hoyt Company committed the following acts of bankruptcy: (a) In paying \$800 of its property to the Fourth National Bank of Atlanta, one of its creditors, on July 7, 1908; it being then insolvent. (b) In paying to J. N. Hirsch, one of its creditors, \$300 of its property during the month of July, 1908, and thereby preferring him over its other creditors; it being then insolvent. (c) By paying to A. C. Woolley & Co., one of its creditors, \$56 during the month of July, 1908, and thereby preferring said Woolley & Co. over its other creditors; it being then insolvent. (d) That it committed an act of bankruptcy in trans-

ferring and conveying to C. A. Bowen on July 31, 1908, who was one of its creditors, also its treasurer and general manager, a large portion of its property, consisting of soda water founts and stands on Decatur street and on Butler street in the city of Atlanta, and that said transfer and sale enabled said Bowen to obtain a preference, and did thereby prefer him over its other creditors; it being then insolvent. (e) Said company committed a further act of bankruptcy, in that it did, while insolvent, on or about the 5th day of August, 1908, by act of its stockholders, authorize and request the appointment of a receiver of its assets by the judge of the superior court of Fulton county, Ga. (f) That it further committed an act of bankruptcy, in that it did, on or about the 22d day of July, 1908, while insolvent, transfer to the West India Manufacturing Company, one of its creditors, \$58 of its property, with intent to prefer this creditor over its other creditors.

"I find the law applicable to the case to be as follows: (1) That, in order to dissolve a corporation in the method attempted by the Adams & Hoyt Company, it must surrender its charter to the state of Georgia, and the surrender must be accepted by the Legislature before the corporation can be dead. This was not done in this case. (2) That, even though the company did surrender its charter and became extinct for all practical purposes, the bankrupt court will consider that the corporation still has sufficient life to enable it to administer the estate under the provisions of the bankrupt act.

"Section 1884 of the Code of Georgia of 1895 provides: 'A corporation may be dissolved by a voluntary surrender of its franchises to the state.' And section 1886 provides: 'Upon the dissolution of a corporation for any cause, all the property and assets of every description belonging to the corporation shall contribute a fund, first for the payment of its debts, and then for equal distribution among its members; to this end the superior court of the county, in which said corporation was located, shall have power to appoint a receiver, under proper restrictions, properly to administer such assets under its direction.' The first above-quoted section is a mere codification of the common law, and did not in any wise change the law existing prior to the adoption of the Code. The charter of the Adams & Hoyt Company was never surrendered to the Legislature, nor accepted by it. It is true a resolution was passed by the stockholders, resolving that a surrender be made, and an effort made to have the superior court of Fulton county accept the surrender. The dissolution is not complete until the surrender is accepted, and the acceptance must be by the Legislature.

"It is said in the case of *Mechanics' Bank v. Heard*, 37 Ga. 401: 'It is contended that a corporation may by "a voluntary surrender of its franchises dissolve itself at its will; that to the resolutions of the corporators surrendering the franchises no subsequent legislative assent is necessary; that in effect an acceptance of such surrender has been given in advance.'" This is certainly startling. Called upon for the first time to interpret the several clauses of the Code touching the dissolution of a corporation, we have felt bound by a high sense of duty to consider carefully the position assumed, and to weigh well the consequences, which, if we were to accede to it, it would induce upon the interests and business of the state. Our proven and undoubted conviction is that it is unsupportable by law and on principle untenable. * * * Our Code, in enumerating the grounds whereby corporations are dissolved, but repeats those existing at common law. Surrender is one of them. A surrender is not a dissolution. It is but a mode, a way, a means to an end. The corporators consent to surrender their franchise, tender it back to the Legislature, and ask to be dissolved as a corporation. This is their free act, and proceeds from one party to the contract. If the surrender is formal, under the seal of the corporation, and the Legislature, the other party to the contract, in behalf of the state, accepts it by an act of ordinance in some authoritative form, and that is authenticated, as laws and ordinances usually are, then, and not till then, is the dissolution of a corporation complete. Our Code, whilst it but repeated the grounds whereby dissolution of corporations is perfected at common law, has omitted to prescribe any forms to be pursued. This is not surprising, as, in condensing the leading principles of the common law, the codifiers were compelled to exclude leading titles, necessarily inferential, without specification. Adopting the ground of dissolution at

common law, the Code would have but contemplated that those grounds should be executed in the forms of the common law as the identity of surrender at common law as a mode of dissolution of a corporation. With the surrender defined by the Code, it cannot but be conceded by every lawyer who will take the trouble of investigating the subject that no mode or form is prescribed by the Code as necessary to be pursued in order to make it effectual. There seems to me no escape from the necessity of alleging an insupport of such allegation accepting some act of ordinance of the Legislature, approved by the Governor, assenting to or accepting the proposed surrender of their franchise.'

"No power is given to the superior court to accept a voluntary surrender of a franchise and charter of a corporation. The act of granting a charter by the court is legislative, and not judicial. The superior court may give life to a corporation, but it has no authority to assent to its committing suicide. It is said in *Gibson v. Thornton*, 107 Ga. 562, 33 S. E. 896: 'In the absence of express statutory authority, a court of equity has no power to dissolve a corporation and appoint a receiver to administer its assets.' The case of *Branch Sons & Company v. Knapp*, 61 Ga. 615, is a case where the corporation had surrendered its charter and the surrender accepted by the Legislature. It is said in 10 Cyc. p. 1199, citing principal Georgia cases: 'The dissolution of a corporation may be effected by the concurrent act of the state and the corporation; the corporation surrendering, and the state accepting the surrender of, its franchises, without the intervention of any judicial proceedings for that purpose. The doctrine is frequently announced in judicial proceedings that a corporation cannot dissolve itself by a mere corporate act, or by vote of a majority of the members, so as to escape its responsibilities or liabilities, but that a surrender of its franchises by a corporation must, in order to be effective, be followed by an acceptance on the part of the state.' The Code itself requires a surrender to be made 'to the state,' thereby excluding the idea that a surrender can be made by surrendering to a court.

"From the foregoing, it is obvious that the Adams & Hoyt Company has never legally surrendered its franchises, and accomplished a dissolution in the manner as provided and contemplated by the Code of Georgia. As to whether this provision of the state law is superseded by the act of Congress known as the 'Bankrupt Act,' and whether the federal courts will still consider the entity of the corporation as sufficient to give jurisdiction to adjudge it bankrupt, the true rule stated in section 97 of Remington on Bankruptcy is as follows: 'A corporation, ceasing to do business after the commission of an act of bankruptcy, does not defeat bankruptcy, as not being principally engaged in any business. Logically the dissolution of a corporation, after its commission of an act of bankruptcy, and before the filing of a petition, would defeat the jurisdiction of the bankruptcy court. Being no longer a corporation, it could not be a bankrupt corporation. However, where such dissolution is a mere incident to the winding up of the corporate affairs and the collection and distribution of its assets, such dissolution will not defeat the jurisdiction; the fiction of corporate entity giving way to the reality of business needs.' It is said in 1 Current Law, p. 736: 'Notwithstanding a decree in a state court, declaring a corporation dissolved and appointing receivers, a federal court may have jurisdiction of a creditors' petition to have the corporation adjudged a bankrupt.'

"A well-considered case is that of *Scheuer v. Book, etc., Co.*, 7 Am. Bankr. Rep. 390, 112 Fed. 407, 50 C. C. A. 312, Circuit Court of Appeals, Fifth Circuit, opinion by Judge Pardee. It is said: 'Where a corporation, while insolvent, has suffered and permitted some of its creditors to obtain preferences through legal proceedings, and then its stockholders and officers sue for and obtain a dissolution for the express purpose of hindering and delaying creditors, and the effect of the proceeding is to permit the alleged preferences to stand in full force, and to actually hinder and delay other creditors, it has committed an act of bankruptcy within the meaning of section 3a (Act July 1, 1898, c. 541, 30 Stat. 546 [U. S. Comp. St. 1901, p. 3422]), which warrants and requires its adjudication as an involuntary bankrupt.' In this case the company was adjudged a bankrupt, notwithstanding it had been dissolved in the proper method, as authorized by the laws of Alabama. In *Re Storck*

Lumber Company (D. C.) 8 Am. Bankr. Rep. 86, 114 Fed. 360, the correct principle is stated in the following language: 'Upon the broad principle that the national bankrupt law is to govern the administration of the estate of all insolvent debtors, and supersedes all the state laws having the like object, when its provisions are invoked by the requisite creditors and acts of bankruptcy are proven, a motion made by the receiver of a corporation, appointed under a suit for winding up insolvent corporations, which is in the nature of a proceeding in insolvency, to quash the petition in involuntary bankruptcy theretofore filed against the corporation, upon the ground that the state court had full jurisdiction when it entered its decree dissolving the corporation, and that, when said petition was filed, the corporation was no longer in existence, must be overruled.' In this case the corporation had been dissolved, and a receiver appointed in the state court. Subsequently thereto an involuntary petition was filed, and adjudication followed.

"In the case of Tiffany v. Condensed Milk (D. C.) 15 Am. Bankr. Rep. 417, 141 Fed. 444, it is said: 'As to such debts an individual does not lose his proven character by ceasing to carry on the business in which they were contracted and turning to another in which he is not liable to bankruptcy, and neither does a corporation by stopping business altogether and going into liquidation, voluntarily or involuntarily. In either case, as to debts previously contracted, the business character of such person, in contemplation of the law, remains the same.' In the case of International Coal Mining Company (D. C.) 16 Am. Bankr. Rep. 312, 143 Fed. 665, it is said: 'The title to this exhibited real estate must remain in the corporation until sold, and a dissolution cannot take place so long as this asset exists, even under that act; and, even if this were not so, the bankrupt law would so far control the matter of the dissolution of the insolvent corporation as to prevent its legal extinction by superseding all state laws in conflict with its provisions as to an extent necessary to enable creditors of insolvent corporations to have the assets of their insolvent debtor administered in accordance with its terms.' In the case of Cole & Company v. Stauffer, 17 Am. Bankr. Rep. 577, 148 Fed. 981, 78 C. C. A. 609, it is said: 'It is, however, strenuously insisted that this act of the board of directors was a nullity, for the reason alleged, that at the time it was made the corporation had ceased to exist, and therefore that the directors and all other officers were *functi officii*. It is true that the law already referred to provides that the property of the corporation sold under the special *fi. fa.* should pass to the purchaser, thus, in effect, terminating the old corporation. If, however, the proceeding by which this property and franchises was sold was an act of bankruptcy, it was void and of no effect. If it were not, still the existence of the corporation is not terminated in every respect by this requirement of the state act. It has often been held that, even where a charter expires by time, its existence will be considered as being extended for the purpose of winding up its affairs, securing creditors, and satisfying the ends of justice, even without special statutory authority for that purpose, and we think that the paramount authority of the federal bankrupt law is sufficient to keep alive the corporation in this case for the purpose of the bankrupt jurisdiction created by the said act, and to give efficacy to the admission made by the directors of the insolvent corporation as an act of bankruptcy.'

"It is said in *Re Underwear Company* (D. C.) 18 Am. Bankr. Rep. 623, 153 Fed. 224: 'It seems to me that upon this record alone it must be apparent to any reasonable mind that the facts found by that court show that it was because of insolvency that the receiver was appointed.' Holding that the appointment of a receiver in such a case amounted to an act of bankruptcy, and that, notwithstanding a dissolution of the corporation, the federal court had authority to adjudge the company a bankrupt, it adjudicated it in that case. In *re Mungler Vehicle Tire Company*, 19 Am. Bankr. Rep. 785, 159 Fed. 901 (Circuit Court of Appeals, Second Circuit), is a case where the Governor of New Jersey had declared the charter of the company forfeited, and subsequently thereto a petition in bankruptcy was filed, and the court holds that such a dissolution of the corporation does not prevent its adjudication.

"These conclusions being sound, I am constrained to hold that adjudication should be had, and an order may be taken accordingly."

Exceptions to the above report were filed, and the questions made by the answers and these exceptions have been argued and submitted.

It is not questioned here, if evidence can be heard outside of what appears in the record of the superior court, that the Adams & Hoyt Company was insolvent for some months prior to the time the petition was filed in the superior court. It is not questioned that the acts of bankruptcy were committed, as found by the special master. It is earnestly contended, however, that the law under which these proceedings in the superior court were instituted was not an insolvency law, which was superseded by the bankruptcy act. It is contended, also, that corporations such as the Adams & Hoyt Company, created by the Superior Court under the law of the state, may surrender their charters and terminate their existence by filing a petition such as filed in this instance in the superior court, although it is conceded that corporations created by the Legislature can only terminate their existence, prior to the time their charters expire by limitation, by surrendering the same to the Legislature and obtaining an act accepting the surrender of the charter. Be all this as it may, I can express my opinion on the issues here in a very few words.

Assuming that the Adams & Hoyt Company, while insolvent, within four months prior to the filing of the petition in bankruptcy, committed certain acts of bankruptcy, I do not believe that it could escape and avoid the jurisdiction of the bankruptcy court by instituting a proceeding such as was instituted by this company in the superior court. The jurisdiction of the bankruptcy court attached, or its right to act arose, when the company, being insolvent, committed the acts of bankruptcy. Any other view of the matter would destroy the effect of the bankruptcy act entirely. It is the paramount law for the administration of estates of insolvents. Its provisions, which seek to bring about equality among creditors of the same class, cannot be avoided in this way. The effect of proceedings such as were instituted by this corporation in the superior court, if sustained, would be that an insolvent corporation could, in clear and gross violation of the bankruptcy act, transfer all of its property to one or more of its creditors, to the exclusion of all of its other creditors, and the corporation would thereby create a preference or preferences which would undoubtedly be set aside under the bankruptcy act, but the corporation would avoid the operation and effect of the bankruptcy act by this new method of procedure. The right of the bankruptcy court to take charge of the corporation's effects and to administer the same in accordance with the bankruptcy act, thereby bringing about equality of payment among creditors of the class, arose and was in existence at the time the petition in the same court was filed. It still exists unaffected, in my judgment, by what was done in the superior court.

I do not discuss this case, except in its general aspect. It is sufficiently dealt with in detail by the special master in his report. The view here taken is sustained, I think, by the authorities cited by the special master, under the bankruptcy act of 1898. See, also, Remington on Bankruptcy, § 97. It is certainly sustained by authorities under Act March 2, 1867, c. 176, 14 Stat. 517. In re Independent In-

insurance Company, Fed. Cas. No. 7,018, approved in the Circuit Court, Fed. Cas. No. 7,017, and In re Mercantile Insurance Company, Fed. Cas. No. 9,431.

The exceptions to the special master's report will be overruled, and an order entered adjudging the Adams & Hoyt Company bankrupt.

UNITED STATES v. RICKEY LAND & CATTLE CO. et al.

(Circuit Court, N. D. California. June 26, 1908.)

No. 13,950.

1. INJUNCTION (§ 49*)—GROUNDS—FLOODING LANDS.

Including the land of another in a reservoir basin and flooding the same constitutes a permanent obstruction to its use by the owner, which entitles him to an injunction.

[Ed. Note.—For other cases, see Injunction, Cent. Dig. § 102; Dec. Dig. § 49.*]

2. WATERS AND WATER COURSES (§ 18*)—PUBLIC LANDS—WATER RIGHTS—RIGHT OF WAY FOR CANAL OR RESERVOIR.

Vested rights in public lands to right of way for ditches, canals, or reservoirs for water purposes, under Rev. St. §§ 2339, 2340 (U. S. Comp. St. 1901, p. 1437), are not acquired until the actual completion of the work, so that the water can be applied to beneficial use.

[Ed. Note.—For other cases, see Waters and Water Courses, Cent. Dig. § 10; Dec. Dig. § 18.*]

3. WATERS AND WATER COURSES (§ 12*)—PUBLIC LANDS—WATER RIGHTS—APPROVAL.

Under Act March 3, 1891, c. 561, §§ 18, 19, 26 Stat. 1101, 1102 (U. S. Comp. St. 1901, pp. 1570, 1571), granting right of way for irrigating canals, ditches, and reservoirs over the public lands to irrigation companies, upon the filing of a map thereof and its approval by the Secretary of the Interior, such approval is essential, and where it was refused as to a reservoir because the site had been previously withdrawn from sale or entry and reserved by the United States, the company acquired no right or easement by the filing of its maps.

[Ed. Note.—For other cases, see Waters and Water Courses, Dec. Dig. § 12.*]

4. WATERS AND WATER COURSES (§ 26*)—PUBLIC LANDS—WATER RIGHTS—RIGHT OF WAY FOR IRRIGATION.

An appropriation of water, duly made and maintained under the laws of California, gives no right of way over the public lands of the United States for a reservoir or canal to use the water. The withdrawal of the land after the appropriation and before the filing of an application for such right of way for irrigation purposes under Act March 3, 1891, c. 561, §§ 18, 19, 26 Stat. 1101, 1102 (U. S. Comp. St. 1901, pp. 1570, 1571), defeats such subsequent filing.

[Ed. Note.—For other cases, see Waters and Water Courses, Cent. Dig. § 17; Dec. Dig. § 26.*]

In Equity. On motion for preliminary injunction.

Robt. T. Devlin, U. S. Atty., and George Clark, Asst. U. S. Atty. Peck & Boynton, for defendants.

DE HAVEN, District Judge. The questions to be decided at this time are presented by the demurrer of the defendants to the bill of complaint, and by the application of the complainant for an injunc-

*For other cases see same topic & § NUMBER in Dec. & Am. Digs. 1907 to date, & Rep'r Indexes

tion pendente lite and the affidavits and documentary evidence used upon the hearing of that application. The bill alleges, in substance, that the United States is the owner of certain described lands, which are a part of a natural basin, including what is known as "Alkali Lake"; that said lands have been withdrawn from entry and reserved by the Secretary of the Interior for reservoir purposes, in accordance with the laws of the United States; that the defendants are constructing and have constructed three canals or ditches by which they take water from the West fork of Walker river and conduct it upon said lands and overflow the same; that defendants claim an easement therein for reservoir purposes, and the right to flood and overflow them; and that said claim is without right. It is further alleged that by flooding the same the defendants will wholly exclude the plaintiff from the use thereof and destroy the value of said lands to the plaintiff. The prayer of the bill is that the claim of defendants to an easement in said lands be adjudged without merit, and that they be restrained from flooding and using the same as a reservoir site. The defendants have demurred to the bill upon the ground that it does not state facts entitling the complainant to the relief sought for, or to any relief.

1. The demurrer must be overruled. The flooding of the lands by the defendants, in the manner alleged in the bill, would be a permanent and continuing obstruction to the free use by the complainant of its property, and this is a wrong which a court of equity will prevent by its writ of injunction. *Learned v. Castle*, 78 Cal. 454, 18 Pac. 872, 21 Pac. 11; *United States Freehold L. E. Co. v. Gallehos*, 89 Fed. 769, 32 C. C. A. 470.

2. Passing to the question of the right of complainant to an injunction pending the final hearing and decree, it may be said that the affidavits and documents introduced in evidence upon the hearing of the application for such injunction show that all of the lands described in the bill, except lot 2, in section 35, township 10 N., range 22 E., containing 8.57 acres, are public lands of the United States, and that if defendants are permitted to subject them to use as a part of the reservoir site claimed by them, and in the manner which they contemplate, said lands will be constantly under water and the complainant excluded from any use thereof. These facts entitle the complainant to the preliminary injunction sought, unless, as claimed by the defendants, the defendant Rickey Land & Cattle Company has an easement in the lands described in the bill, entitling it to use the same as a reservoir site.

It appears that the defendant Rickey caused, in the year 1881, a survey to be made of a reservoir site within the limits of which are situated the lands described in the bill, and also caused monuments and stakes to be set so as to mark the boundaries of such reservoir site, and thereafter purchased the Swauger and Wiley ditches, leading from the West fork of Walker river, together with the water rights appertaining to such ditches, and thereafter, and before August, 1902, extended these ditches, and also another ditch owned by him, and known as the Rickey ditch, so as to discharge the water carried by them on the lands lying within the basin in which said reservoir site

is situated. These ditches were not originally constructed for the purpose of taking water from the West fork of Walker river and irrigating lands within the reservoir basin, or storing the same within the limits of the reservoir site, but were constructed for the purpose of irrigating lands outside of said basin. The cost of enlarging and extending these ditches exceeded the sum of \$15,000.

The defendant Rickey Land & Cattle Company is a corporation which was duly organized under the laws of the state of Nevada July 25, 1902, and is a ditch and canal company formed for the purpose of irrigating lands, and on August 6, 1902, the defendant Rickey conveyed to it all his right, title, and interest in said reservoir site, and the ditches and canals leading thereto, and the water rights appertaining to such ditches, and all lands owned by him forming part of said reservoir site and lying adjacent thereto. The practical use of said reservoir requires that water impounded therein shall be conducted from the reservoir into the West fork of Walker river, and distributed from said West fork in ditches taken out of that stream below the point where the water from the reservoir is discharged into said river, and in order to make any beneficial use of the water impounded in said reservoir by the distribution thereof, the reservoir must have an outlet or ditch conveying the water onto the land requiring irrigation lying below the reservoir. This outlet has not yet been constructed, although it appears from the affidavit of the defendant Rickey that it is the intention of the defendant corporation to construct such outlet and that work thereon has been commenced.

Upon September 11, 1902, the defendant corporation duly posted and recorded in the office of the county recorder of Mono county, state of California, a notice to the effect that it appropriated all the waters of the West fork of Walker river flowing in said stream from the 1st day of October of each year to the 1st day of April of the following year, to the extent of 50,000 inches or more, measured under a 4-inch pressure, and all the surplus and unappropriated waters flowing in that stream from the 1st day of April to the 1st of October of each year, amounting to 50,000 inches or more, measured under a like pressure of 4 inches, and further stating that the purpose for which said water was claimed and appropriated was to store the same in a reservoir, and to use, sell, and distribute the same for domestic, irrigation, mechanical, and power purposes, and that the reservoir in which said water was to be stored is that certain lake known as "Alkali Lake," situated in Antelope Valley, and in Douglas county, Nev., and Mono county, Cal., being the same reservoir site in controversy here. The defendant corporation also, on September 11, 1903, caused to be recorded in the county recorder's office of the county of Mono, Cal., and in the office of the recorder of Douglas county, Nev., a notice of the location by it of said reservoir. Said notices were also posted upon the margin of the reservoir so located.

On the 19th of December, 1902, the defendant corporation filed with the register of the United States land office, in the proper land district in California, and on January 10, 1903, also filed with the register of the United States land office at Carson, in the state of Nevada, a map of the reservoir site in controversy, showing the canals and ditches

leading thereto, and also showing the proposed line of the tunnel and canal leading from the reservoir through and over the land lying below said reservoir site—that is to say, the proposed line of the tunnel and canal through which the water impounded in said reservoir is to be discharged—and also filed with said registers certified copies of its articles of incorporation, and also proof of its organization under said articles, and the maps and documents so filed with said registers were by them forwarded to the Commissioner of the General Land Office; and the said application by the defendant corporation for right of way for said reservoir was rejected by said Commissioner, February 20, 1907, and his action was affirmed by the Secretary of the Interior on October 11, 1907. It appears, further, that the lands described in the complaint were withdrawn from sale and reserved by the Secretary of the Interior of the United States for reservoir purposes on September 13, 1902.

The foregoing is a sufficient statement of the material facts shown by the affidavits and documentary evidence introduced upon the hearing of the application for an injunction pendente lite, and upon these facts the defendants claim that prior to their withdrawal from entry and reservation, September 13, 1902, the Rickey Land & Cattle Company acquired title to an easement in the lands described in the bill of complaint for a reservoir site, under sections 2339 and 2340 of the Revised Statutes of the United States (U. S. Comp. St. 1901, p. 1437), and also under the provisions of sections 18 and 19, of the act entitled "An act to repeal timber-culture laws, and for other purposes" (Act March 3, 1891, c. 561, 26 Stat. 1101, 1102 [U. S. Comp. St. 1901, pp. 1570, 1571]). Sections 2339 and 2340 of the Revised Statutes (U. S. Comp. St. 1901, p. 1437), so far as necessary to be here stated, are as follows:

"Sec. 2339. Whenever, by priority of possession, rights to the use of water for mining, agriculture, manufacturing, or other purposes, have vested and accrued, and the same are recognized and acknowledged by the local customs, laws, and the decisions of courts, the possessors and owners of such vested rights shall be maintained and protected in the same; and the right of way for the construction of ditches and canals for the purposes herein specified is acknowledged and confirmed. * * *

"Sec. 2340. All patents granted, or pre-emption or homesteads allowed, shall be subject to any vested and accrued water rights, or rights of ditches and reservoirs used in connection with such water rights, as may have been acquired under or recognized by the preceding section."

It is very clear that no one can under these sections acquire as against the government a vested easement in and to public lands for a reservoir site until the actual completion of the reservoir, so that the waters to be impounded therein could be applied to the beneficial uses contemplated by the irrigation system of which it forms a part. This was the construction placed upon these sections by the Supreme Court in *Bear Lake Irrigation Co. v. Garland*, 164 U. S. 1, 18, 19, 17 Sup. Ct. 7, 12, 41 L. Ed. 327, in which case it was said:

"It is the doing of the work, the completion of the well, or the digging of the ditch, within a reasonable time from the taking of possession, that gives the right to use the water in the well or the right of way for the ditches or the canal upon or through the public land. Until the completion of this work, or, in other words, until the performance of the condition upon which the

right to forever maintain possession is based. the person taking possession has no title, legal or equitable, as against the government."

Now the reservoir site, claimed by the defendants, is a natural basin at the base of a spur of the Sierra Nevada Mountains, and the lands described in the bill were withdrawn from entry and reserved on September 13, 1902; but at that date, and, indeed, when this action was commenced, no outlet to this natural basin had been completed, nor any ditch or canal constructed for the distribution of waters upon the lands intended to be irrigated from waters impounded in such reservoir. The reservoir was therefore not completed at the time the lands were withdrawn from entry, as, without an outlet, water which might be impounded therein could not be applied to any beneficial use.

3. The defendants further claim that the Rickey Land & Cattle Company acquired the right to occupy the lands in controversy as a reservoir site under sections 18 and 19 of the act entitled "An act to repeal timber-culture laws, and for other purposes" (Act March 3, 1901, c. 561, 26 Stat. 1101, 1102 [U. S. Comp. St. 1901, p. 1437]), by filing with the register of the land office in the district in which such land is located a map of its canals and ditches and reservoir. Section 18 of the act referred to provides:

"That the right of way through the public lands and reservations of the United States is hereby granted to any canal or ditch company formed for the purpose of irrigation, and duly organized under the laws of any state or territory, which shall have filed or may hereafter file with the Secretary of the Interior, a copy of its articles of incorporation, and due proofs of its organization under the same, to the extent of the ground occupied by the water of the reservoir and of the canal and its laterals and fifty feet on each side of the marginal limits thereof. * * *"

Section 19 of the same act is as follows:

"That any canal or ditch company desiring to secure the benefits of this act shall, within twelve months after the location of ten miles of its canal, if the same be upon surveyed lands, and if upon unsurveyed lands, within twelve months after the survey thereof by the United States, file with the register of the land office for the district where such land is located a map of its canal or ditch and reservoir; and upon the approval thereof by the Secretary of the Interior the same shall be noted upon the plats in said office, and thereafter all such lands over which such rights of way shall pass shall be disposed of subject to such right of way. * * *"

It will be seen that by the express terms of this section, in order to acquire a right of way over public lands for canal and reservoir purposes under the act of which it forms a part, it is essential that the map of the location of the canal and the reservoir shall be approved by the Secretary of the Interior. Such approval is a condition precedent to the taking effect of the grant of right of way for the purposes named in the preceding section of the act. *Nippel v. Forker*, 26 Colo. 74, 56 Pac. 577. This being so, it must be held that the Rickey Land & Cattle Company has not acquired any easement in the lands in controversy for a reservoir site under sections 18 and 19 of the act above referred to; the Secretary of the Interior having refused to approve the map of the location thereof filed by that company.

The application of the complainant for an injunction during the pendency of the action, restraining the defendants from using the lands

described in the bill of complaint as a reservoir, or part of a reservoir, for the storage of water for distribution, will be granted; such injunction, however, not to interfere with the right of defendants to irrigate any lands now irrigated by water carried in the ditches referred to in the bill of complaint, or to irrigate any lands capable of irrigation by water carried in such ditches.

The demurrer to the bill of complaint is overruled: the defendants to have until the first Monday of August, 1908, to answer.

MORRELL v. GEO. BROOKS & SON CO.
(Circuit Court, D. Delaware. October 21, 1908.)

No. 289.

INJUNCTION (§ 69*)—CORPORATIONS—ILLEGAL ACTS OF DIRECTORS.

A Circuit Court of the United States, other requisites to the exercise of jurisdiction being satisfied, will enjoin de facto equally with de jure officers of a corporation from perpetrating, facilitating or permitting violations of law to the detriment of innocent stockholders who have no adequate remedy at law and are unable to induce the corporation to adopt effective measures for their protection.

[Ed. Note.—For other cases, see Injunction, Cent. Dig. § 136; Dec. Dig. § 69.*]

(Syllabus by the Court.)

In Equity.

C. L. Ward and Herbert H. Ward, for complainant.

Willard Saulsbury and Charles M. Curtis, for defendant.

BRADFORD, District Judge. This is an application by Richard B. Morrell on bill and affidavits for a preliminary injunction against Geo. Brooks & Son Company. The defendant is a corporation of Delaware, created and organized in October, 1901, under the general incorporation act of March 10, 1899 (Laws 1899, p. 445, c. 273), with a total authorized capital stock of \$300,000, consisting of \$200,000 of common stock, divided into shares of \$100 each, and \$100,000 of preferred stock, also divided into shares of \$100 each. The original incorporators were the complainant, Henry Brooks, now deceased, and William M. Pyle. The whole amount of the authorized stock, both common and preferred, has been issued and is outstanding. The common stock is held and owned as follows: The complainant 997 shares, Pyle 3 shares, the estate of Henry Brooks, deceased, 985 shares, and George H. Brooks, John W. H. Brooks and Marshall A. Brooks 5 shares each. Of the preferred stock the estate of Henry Brooks, deceased, owns and holds 995 shares, and John B. Wurtz the remaining 5 shares. The complainant is thus the owner of more than one-third of the total common stock, and he and Pyle together own just one-half of it; the other half being owned by persons antagonistic to the complainant. Section 137 of the general incorporation act (page 502) provides, among other things, as follows:

*For other cases see same topic & § NUMBER in Dec. & Am. Digs. 1907 to date, & Rep'r Indexes

"Every corporation shall have power to create two or more kinds of stock of such classes, with such designations, preferences and voting powers, or restriction or qualification thereof, as shall be stated and expressed in the certificate of incorporation."

Pursuant to and in accordance with this authority article 4 of the certificate, after providing for common and preferred stock, declares:

"The holders of said preferred stock shall not be entitled, by reason of their holdings thereof, to any voice or vote in the management or affairs of the corporation. The voting power shall be confined to the holders of the common or general stock."

Article 8 provides, among other things, as follows:

"With the consent in writing and pursuant to a vote of the holders of 66% per cent. of the capital stock issued and outstanding, the stockholders shall have authority to dispose, in any manner, of the whole property of this corporation."

It appears that April 10, 1908, the holders of two-thirds of the \$300,000 of the stock, common and preferred, although not holding two-thirds of the common capital stock issued and outstanding, united in a formal request addressed to the complainant as president of the defendant, for the calling of a special meeting of the stockholders—"for the purpose of electing directors, voting upon the question of selling the assets to George Brooks & Son, Incorporated, and transacting such other business as may be brought to the attention of the meeting."

This request was based in part on the consent in writing on the same day of the several persons uniting in such request. The body of the written consent was as follows:

"The undersigned, holders of 66% per cent. of the capital stock issued and outstanding of the George Brooks & Son Company, hereby consent in writing to dispose of and sell the whole property of said company to another corporation, named George Brooks & Son, Incorporated, upon the following terms: The new corporation, which has a capital stock of \$350,000, composed of \$150,000 of preferred stock and \$200,000 of common stock, is to give to the holders of preferred and common stock share for share of like par value for their present holdings. It is also to give to the holders of the preferred stock, new preferred stock aggregating \$26,000 for the arrearages of dividends due on the present preferred stock. The \$24,000 of additional preferred stock is to be treasury stock to be used for corporate purposes as ordered by the stockholders and directors of the new company."

The complainant did not join in the written request above referred to, nor did he as president or in any other capacity call or cause to be called a special meeting of stockholders for the purpose of "voting upon the question of selling the assets to George Brooks & Son, Incorporated"; but pursuant to call a special meeting of stockholders was held May 11, 1908, for the purpose of electing directors of the defendant. At that meeting, against the protest of the complainant or his attorney, the \$100,000 of preferred stock, together with \$100,000 of the common stock, was voted for three proposed directors who were declared elected. Thereafter and on the same day the persons so declared elected took forcible possession of the business office, safe and books of the defendant and physically ejected from the office the person who up to that time had been and was recognized as treasurer of the defendant. Thereafter, May 16, 1908, Marshall A. Brooks, the

secretary or assuming to act as the secretary of the defendant, issued a call for a special meeting of stockholders to be held May 28, 1908, for "the purpose of voting on the question of selling all of the property of Geo. Brooks & Son Company to Geo. Brooks & Son, Incorporated," furnishing a certified list of stockholders, including those holding preferred as well as those holding common stock, and sending May 21, 1908, such certified list to the attorney of the complainant in a letter, saying:

"Enclosed please find a certified list of the stockholders entitled to vote at the stockholders' meeting of the Geo. Brooks & Son Co. to be held May 28, 1908."

Under these circumstances the complainant filed his bill May 26, 1908, praying, among other things, that the defendant, its officers and agents, or other persons controlling it, be restrained and enjoined as follows:

"From accepting, considering or counting any ballots or votes of the holders of the preferred shares of the capital stock of said corporation based upon said preferred shares or the ownership thereof, at any meeting of the stockholders, regular or special, of said defendant corporation, upon any question, and more particularly upon any question involving the voting or consent of the holders of said preferred shares for or against the sale of the assets or property of said defendant corporation to any other person or corporation, and from in any manner selling or disposing of the assets or property of said corporation to any other person or corporation without the consent in writing and the vote of 66 $\frac{2}{3}$ per centum of the common capital stock of the said corporation issued and outstanding, until the further order of the court."

The argument at the hearing took a wide range, covering many points unnecessary seriously to discuss. If the holders of preferred capital stock of the defendant are not, as such, entitled to vote on the question of transferring all its assets to another company, the complainant has made a case entitling him to equitable relief under the injunctive power. For I am satisfied that the complainant has no adequate remedy at law. This court will not undertake, solely by reason of illegality in their choice, to oust or enjoin de facto officers of the defendant. But it will enjoin de facto equally with de jure officers of a corporation from perpetrating, facilitating or permitting violations of law to the detriment of innocent stockholders who have no adequate remedy at law and are unable to induce the corporation to adopt effective measures for their protection. The writ of quo warranto cannot avail in such a case; for it is wholly inapplicable. The principal point to be decided is whether preferred stockholders of the defendant have the right to vote on the question of transferring its assets to another company. I am satisfied that they do not have such right. Article 8 of the certificate of incorporation, it is true, provides that with the written consent and pursuant to the vote of the holders of two-thirds of "the capital stock issued and outstanding" all the property of the defendant may be disposed of; and, undoubtedly, were there nothing in the certificate to negative the existence of such right on the part of preferred stockholders, it would be necessary to hold that "the capital stock issued and outstanding" includes preferred as well as common shares. But article 8 must be read in the light of other provisions of the certificate. Article 4 not only provides, by way of negation, that preferred stockholders shall not, as such, have "any

voice or vote in the management or affairs of the corporation," but declares, by way of affirmation, that "the voting power shall be confined to the holders of the common or general stock." To overcome the force of the restriction contained in article 4 it would be necessary that article 8 should expressly provide for the consent and vote of the holders of two-thirds of the capital stock, "preferred and common," issued and outstanding. But the latter article contains no designation of preferred stock. Under the circumstances the words "capital stock issued and outstanding" must be read "common capital stock issued and outstanding," or "capital stock, entitled to a vote, issued and outstanding." So read, article 8 is in harmony with article 4. Such a reading does no violence to the language of article 8, for the words "capital stock issued and outstanding" are in and by themselves capable of application to common stock, or to preferred stock, or to common and preferred stock together. If, however, the words "capital stock" in article 8 be read "capital stock, preferred and common," a gross repugnancy is introduced in the certificate of incorporation; for such a reading would be wholly irreconcilable with the provision in article 4 that "the voting power shall be confined to the holders of the common or general stock." It is contended that the clause of article 8 now under consideration applies to a special subject of an important and exceptional nature, and that the stockholders' vote therein provided for was intended by the incorporators to be excepted from the generality of the prohibition in article 4. On the hypothesis of the existence of such an intention it would have been highly probable either that article 4 would have contained some such saving clause as "except as hereinafter provided to the contrary," or that article 8 would have expressly referred to preferred and common stock. In the absence of such saving or reference the only basis for the contention is groundless surmise. Indeed, in the nature of the case, and aside from the particular provisions which have been quoted, there is an inherent improbability that the incorporators entertained any such intention. Article 4 provides:

"The holders of preferred stock shall, in case of liquidation or dissolution of the company, be entitled to be paid in full, both the principal of their shares and the accrued dividends charged before any amount shall be paid to the holders of the general or common stock."

Article 8, as hereinbefore stated, provides that the stockholders, with the written consent and pursuant to the vote of the holders of the requisite proportion of the capital stock, shall have authority "to dispose in any manner of the whole property of this corporation." The legitimate construction of the clause cannot vary with the varying manner in which the property may be disposed of. Such construction must be uniform whether the stockholders proceed to dispose of all the assets for the purpose of acquiring stock in another company, or for money to be distributed among the creditors and stockholders of the defendant in the course of liquidation. In order to test the question of the proper construction of the clause let it be assumed that the stockholders propose to sell all the assets and distribute the proceeds. In that event, after the payment of debts and expenses, the holders of preferred stock

are entitled, before payment can be made on account of the common stock, to be "paid in full both the principal of their shares and the accrued dividends." Hence, the pecuniary interest of the preferred stockholders would be fully satisfied by a sale of the assets for enough money to pay debts, expenses and the capital and accrued dividends of their stock, although not a dollar should be left to apply to the common stock. On the other hand, in the absence of fraud and collusion, which are not to be presumed, between the common stockholders and a portion of the preferred stockholders, the conservation and protection of the pecuniary interest of the former require that a sale of the assets should be at a price more than sufficient to pay debts, expenses and the capital and accrued dividends of the preferred stock. The above considerations furnish a cogent reason why the incorporators should vest in the common stockholders alone the power to dispose of all the assets of the defendant by way of sale. And if they alone have power to sell all the assets, uniformity of construction requires that they alone have authority to dispose of the same in any other manner. Further, aside from the provision quoted from article 8, there is nothing in the certificate of incorporation to lend the slightest color to the contention that the voting power for any purpose is vested in preferred stockholders as such. That provision is limited to cases in which it is proposed "to dispose in any manner of the whole property" of the defendant. It has no application to the disposal of only a part of the assets in the conduct of the business or otherwise. The power of such partial disposal beyond all controversy resides either mediately or immediately in the common stockholders exclusively. No canon of construction justifies such a reading of the indefinite language of article 8 as to authorize preferred stockholders by their action in conjunction with that of the common stockholders to dispose of the whole property of the defendant, and to prohibit the preferred stockholders from consenting and voting, with the common stockholders, to dispose of one-half or nine-tenths of the total assets. The by-laws of the defendant also afford evidence of an intention and understanding on the part of the original incorporators that all voting power should be and was confined to the common stockholders. Article III provides, among other things, as follows:

"The one hundred thousand of preferred stock shall have no vote in the transaction of any business of the company, being a first lien on all the property, and in case of liquidation shall be redeemed at par. * * * The two hundred thousand common stock shall have and possess all voting power; shall meet and elect board of directors once a year, alter and amend by-laws, and, in fact, exercise all the power of stockholders as hereinafter provided."

On the whole I am clearly of opinion that the preferred stockholders, as such, have no authority to vote for a sale or other disposition of the whole or any part of the assets of the defendant, or on any question affecting its business or affairs, and that the complainant is entitled to a preliminary injunction in accordance with the hereinabove quoted portion of his prayer in that behalf. An interlocutory decree for the complainant may be prepared and submitted.

Ex parte LEE SHER WING.

(District Court, N. D. California. October 19, 1908.)

ALIENS (§ 23*)—CONSTRUCTION OF IMMIGRATION ACT—CHINESE—EXCLUSION BECAUSE OF DISEASE.

The provisions of Immigration Act Feb. 20, 1907, c. 1134, 34 Stat. 898 (U. S. Comp. St. Supp. 1907, p. 391), excluding alien immigrants afflicted with certain diseases, etc., are applicable to Chinese immigrants otherwise entitled to admission.

[Ed. Note.—For other cases, see Aliens, Dec. Dig. § 23.*]

Habeas Corpus. On demurrer to petition.

McGowan & Worley and J. J. Dunne, for petitioner.

R. T. Devlin, U. S. Atty., and A. P. Black, Asst. U. S. Atty., for respondent.

DE HAVEN, District Judge This proceeding is one which arises upon a petition filed in this court by Lee Yuen, a Chinese merchant domiciled in the city of San Francisco, state of California. The petition is filed on behalf of his minor son Lee Sher Wing, and alleges that said minor is unlawfully restrained of his liberty, and prays for the issuance of a writ of habeas corpus for the purpose of releasing him from such imprisonment. The petition alleges that Lee Sher Wing is a subject of the Emperor of China, 14 years of age, and that he is desirous of joining the petitioner and remaining with him as a resident of the United States; that the cause of the imprisonment and restraint of said minor is "that the board of immigration inspectors of the United States at the port of San Francisco have ordered said Lee Sher Wing to be deported from such port to the Empire of China, and that such imprisonment and restraint are for the purpose of such deportation; that the alleged (reason for such?) deportation, as your petitioner is informed and verily believes, is that said Lee Sher Wing is suffering from a contagious disease known as 'trachoma.'" It is further alleged that said minor, "at the time of the making of the order of deportation hereinbefore referred to, was not, and is not, suffering with a contagious disease known as 'trachoma,' or any other disease at all."

Upon the filing of the petition the court made an order directing the respondent to show cause why the writ should not issue as prayed for. The respondent appeared in response to said order, and demurred to the petition upon the ground that it does not state facts sufficient to entitle the petitioner to the issuance of the writ prayed for, and upon the further ground—

"that it affirmatively appears from the face of the said petition that the lawfully constituted authorities of the United States, in the lawful exercise of their duty and authority, and after an examination of the said Lee Sher Wing, have found that he was, at the time of the examination, and is now, a person suffering from a dangerous and contagious disease of the eyes, known as 'trachoma.'"

1: Section 2 of the act of Congress entitled "An act to regulate the immigration of aliens into the United States," approved February 20,

*For other cases see same topic & § NUMBER in Dec. & Am. Digs. 1907 to date, & Rep'r Indexes

1907 (34 Stat. 898, c. 1134 [U. S. Comp. St. Supp. 1907, p. 391]), provides that certain classes of persons, including persons "afflicted with tuberculosis or with a loathsome or dangerous and contagious disease," shall be excluded from admission into the United States. The act provides for a physical examination of all aliens at ports of the United States by medical officers of the United States Public Health and Marine Hospital Service, and also for the appointment of boards of special inquiry to determine whether or not any alien belongs to either of the excluded classes; and section 10, of the act provides that the decision of the board of inquiry—

"based upon the certificate of the examining medical officer, shall be final as to the rejection of aliens affected with tuberculosis or with a loathsome or a dangerous contagious disease, or with any mental or physical disability which would bring such aliens within any of the classes excluded from admission to the United States under section 2 of this act."

As before stated, it appears from the petition for the writ that Lee Sher Wing is an alien immigrant and a subject of the Empire of China, and that his right to enter the United States has been denied upon the ground that he is suffering from a contagious disease of the eyes known as "trachoma."

But the petitioner contends that the act of Congress, above referred to, is not applicable to Chinese persons, and for that reason it is claimed that the immigration officers at the port of San Francisco had no jurisdiction to make any inquiry in relation to the health of Lee Sher Wing, or to make the order denying his right to enter the United States upon the ground that he is suffering with a contagious disease. This contention is based upon section 43 of the act above referred to, which declares:

"Sec. 43. That the act of March third, nineteen hundred and three, being an act to regulate the immigration of aliens into the United States, except section thirty-four thereof, and the act of March 22, 1904, being an act to extend the exemption from head tax to citizens of Newfoundland entering the United States, and all acts and parts of acts inconsistent with this act are hereby repealed: Provided, that this act shall not be construed to repeal, alter, or amend existing laws relating to the immigration or exclusion of Chinese persons or persons of Chinese descent. * * *"

A Chinese merchant is entitled to admission into the United States under the Chinese exclusion laws, and his minor child has the right also to enter by virtue of its relationship to the father, whether it accompanies him, or seeks to enter after the father has become domiciled in the United States. *U. S. v. Gue Lim*, 176 U. S. 459, 20 Sup. Ct. 415, 44 L. Ed. 544. There is no provision in these laws to the effect that a Chinese merchant or a member of his family shall be denied admission into this country if suffering from a loathsome or dangerous contagious disease, and counsel for petitioner argues from this that to hold that Act Feb. 20, 1907, c. 1134, 34 Stat. 898, above referred to, is applicable to Chinese, would give to it the effect of altering or amending the Chinese exclusion laws by depriving a class of Chinese, not excluded by those laws, to wit, Chinese merchants afflicted with a loathsome and dangerous contagious disease and members of their families so afflicted, of the right to enter the United

States; and it is contended that in view of the proviso above quoted such construction of the statute is not permissible.

It must be conceded that, if the proviso is to receive a literal interpretation, the contention of the petitioner would be well founded. But when it is considered that the object of the statute is to exclude from the United States certain classes of undesirable alien immigrants, and, among others, alien immigrants suffering from a loathsome or contagious disease, whose presence would endanger the public health, it is at once seen that to permit Chinese persons suffering from such diseases, to enter the United States, would in a measure defeat the primary intention of the statute, and therefore such a construction of the proviso as is contended for by the petitioner is to be avoided. "It is a well-settled rule in the interpretation of statutes that the reason and intention of the lawgiver will control the strict letter of the law when the latter would lead to palpable injustice or absurdity." *Kelley v. Gage County*, 67 Neb. 6, 93 N. W. 194, 99 N. W. 524. "Nothing is better settled," says the Supreme Court, "than that statutes should receive a sensible construction such as will effectuate the legislative intention, and, if possible, so as to avoid an unjust and absurd conclusion." *Lau Ow Bew v. U. S.*, 144 U. S. 47, 12 Sup. Ct. 517, 36 L. Ed. 340; *U. S. v. Gue Lim*, 176 U. S. 459-467, 20 Sup. Ct. 415, 44 L. Ed. 544.

Section 36 of the act to regulate the immigration of aliens into the United States, approved March 3, 1903 (32 Stat. 1221, c. 1012), contains a proviso similar to that which is relied upon by the petitioner here, and the question of the effect of such proviso upon the Chinese exclusion laws was fully considered by Attorney General Knox in an opinion reported in 24 Opinions of Attorney General, p. 706. In that opinion he said:

"There is nothing in the laws specially relating to the immigration of Chinese persons providing for the exclusion of a merchant or member of any other excepted class, although he may be suffering from a loathsome or dangerous contagious disease; and, unless the act now under consideration is applicable to him, such person may enter the United States with impunity, and the public must suffer the consequences. I can see no valid reason for concluding that the Congress intended, by the proviso in question, to imperil the public safety by allowing a diseased person, because of his Chinese descent, to enter, when the very law in which this proviso appears has, as one of its special purposes, the further and more affective protection of the public from the evil consequences to be expected as a result of the presence of one so afflicted, and to this end prescribe his exclusion."

And he added:

"To admit a Chinaman known to be suffering from a contagious disease, when another alien not so descended would be excluded because afflicted with the same disease, would to that extent defeat the legislative intent made clear by the terms of the act and apparently lead to unjust and unexpected results."

And his conclusion was that the proviso was not intended to entirely prohibit the application of the act to persons of Chinese descent; that its object—

"was to prevent a misinterpretation of the repealing clause in the same section, and to forestall any attempt to secure admission to Chinese theretofore prohibited from entering the United States under a claim that this act alone

was intended to contain all provisions regulating the immigration of all aliens, and expressly repealed all laws in conflict therewith—the Chinese exclusion laws among them.”

In my opinion the same construction is to be given to the proviso under consideration here.

The demurrer to the petition is sustained, and the application for the writ of habeas corpus denied.

In re RICE et al.

(District Court, E. D. Pennsylvania. October 14, 1908.)

No. 3,000.

BANKRUPTCY (§ 351*)—PROVABLE CLAIMS—PARTNERSHIP—ADVANCES BY PARTNER.

While the trustee of a bankrupt partner may prove a claim for advancements made by such partner to the firm against the estate in bankruptcy of the partnership, under Bankr. Act July 1, 1898, c. 541, § 5f, 30 Stat. 548 (U. S. Comp. St. 1901, p. 3424), such claim is not entitled to share with other partnership creditors in the estate, but only in the surplus, if any, remaining after their claims are paid in full.

[Ed. Note.—For other cases, see Bankruptcy, Cent. Dig. § 563; Dec. Dig. § 351.*]

In Bankruptcy. On certificate of referee concerning claim of Joseph A. Rice.

Robert S. Siegel, for claimant.

J. Howard Reber and Maxwell H. Kratz, for objecting creditors.

J. B. McPHERSON, District Judge. The order of the learned referee, George F. Coffin, Esq., which the claimant asks the court to review, disallowed and expunged the claim for reasons that are thus stated in the report:

“On the 14th day of January, 1908, Jos. A. Rice, Frank J. Lerch, and Robert N. Weaver, individually and trading as the Lerch & Rice Company, were duly adjudged bankrupts upon a petition filed against them on the 9th day of January, 1908.

“Subsequently, to wit, on the 1st day of February, schedules were filed, both by the partnership and by the individual members thereof, which schedules disclose that the partnership and each individual member thereof were insolvent.

“On the 12th day of May, 1908, the trustee of the partnership, as well as the trustee of the individual estates, filed his account, which shows a balance in his hands for distribution among the firm creditors of \$26,505.56; for distribution among the individual creditors of Jos. A. Rice of \$3,183.60; for distribution among the individual creditors of Frank J. Lerch of \$6,066.72; for distribution among the individual creditors of Robert N. Weaver of \$4,155.59.

“Claims had been filed against the firm and individual estates aggregating more than the balances indicated herein.

“On the 15th day of February, 1908, Jos. A. Rice filed a claim against the Lerch & Rice Company for \$5,210.07, the claim being based on four promissory notes, with credits, and is alleged to be for money advanced to the firm.

“On the 4th day of June, 1908, the Joel Bailey Davis Company, a creditor, filed a formal objection to the allowance of this claim, among others; the objection to the claim under consideration being as follows:

*For other cases see same topic & § NUMBER in Dec. & Am. Digs. 1907 to date. & Rep'r Indexes

"Your petitioner objects to the claim of Jos. A. Rice, in the sum of \$5,210.07, by reason of the fact that said claimant, Jos. A. Rice, was a member of the firm of the Lerch & Rice Company, and therefore, as said firm of the Lerch & Rice Company have been insolvent for a number of years, there should be credited on the indebtedness due the said Jos. A. Rice any and all moneys withdrawn by him from the firm of the Lerch & Rice Company within a period of at least two years prior to the filing of the petition in bankruptcy."

"That on the 9th day of June, 1908, said Jos. A. Rice appeared before the referee by counsel and waived the ten days' notice to which he would be entitled, and by stipulation with counsel for the objecting creditor agreed that testimony should immediately be taken on the allowance or disallowance of his claim.

"The testimony so taken was by stipulation of counsel, then present and consenting thereto, considered to be taken for the purpose of determining the validity of the claim of Jos. A. Rice, as well as the claims of the other partners against the firm. Subsequent meetings, to wit, on June 18, 1908, and June 22, 1908, were held for the purpose of taking testimony. The testimony particularly relating to the claim of Jos. A. Rice was taken on June 22d, and is summarized as follows:

"Jos. A. Rice, the claimant, advanced between October 3, 1898, and October 23, 1905, to the firm of the Lerch & Rice Company, of which he was a copartner, \$5,388.62, on which repayments were made, the balance of which advancements, together with the interest, form the amount of his present claim of \$5,210.07.

"These advancements were all evidenced by notes of the firm, given at or near the respective times when the loans or advancements were made.

"There is no direct testimony as to when the insolvency of the firm began.

"Mr. Rice was unable to say whether there was a loss or profit in conducting the business of the firm in the years 1907, 1906, 1905, or 1904.

"During the five years past, namely, beginning February 1, 1903, to January 1, 1908, Mr. Rice, as a member of the firm, withdrew either in money or merchandise from the firm the sum of \$9,126.24 in the following amounts, viz.:

February 1, 1903, to February 1, 1904.....	\$1,940.13
" " 1904, " " " " 1905.....	1,764.70
" " 1905, " " " " 1906.....	1,956.06
" " 1906, " " " " 1907.....	1,601.50
" " 1907, " January " 1908.....	1,863.85

"The articles of copartnership were not produced, and the testimony is that there was no special or definite arrangement between them as to what amount each partner was privileged to withdraw from the firm's funds, but each partner could take as much as he desired.

"The respective interests of the partners were: Jos. A. Rice, 50 per cent.; Frank J. Lerch, 40 per cent.; Robert N. Weaver, 10 per cent.

"The referee finds the following facts:

"(1) That Jos. A. Rice, the claimant against the Lerch & Rice Company, was a member of that firm when he loaned or advanced to the partnership sums of money which, with a proper allowance of credit, now amounts to \$5,210.07.

"(2) That from February 1, 1903, to January 1, 1908, said Jos. A. Rice withdrew from the firm the sum of \$9,126.24.

"(3) That there is no testimony from which the insolvency of the firm can be found for the period of time specified in the objection of the Joel Bailey Davis Company, namely, from the 1st of January, 1906.

"Opinion and Discussion.

"Although not made a part of the objection filed against this claim, the fact that it is filed in the name of Jos. A. Rice, individually, would properly authorize its being stricken from the record, since it is an asset of the bankrupt's estate, and as such an asset, if of any value, by operation of law has passed to his trustee, and, if maintainable at all, of necessity should be proven by the trustee, and not by the bankrupt himself.

"The objection filed against the claim, while on its face it seems to seek the disallowance of this claim, on the theory that the moneys withdrawn for

the past two years should be credited on the claim itself, contains, however, another allegation, viz., that said Jos. A. Rice was a partner of the firm of the Lerch & Rice Company.

"As to the right of a partner to withdraw from time to time moneys from the partnership, if done by and with the consent of his copartners, there can be no longer any question.

"As is said in *Sargent v. Blake* (C. C. A.) 20 Am. Bankr. Rep. 116, 160 Fed. 57, at page 123 of 20 Am. Bankr. Rep., and page 63 of 160 Fed.:

"In the daily conduct of business, partners are necessarily and constantly applying partnership property to the payment, not only of large individual obligations, but to the payment of their petty individual debts for living expenses, and are often devoting their individual property to the promotion of the partnership business and the discharge of partnership debts.

"It never could have been, it never was, the intention of Congress that these transactions—these transformations of partnership into individual, and of individual into partnership, property—within four months, or within any other time preceding the commencement of bankruptcy proceedings, should either be rescinded or avoided by subsequent adjudications in bankruptcy, unless they were actually fraudulent or voidably preferential."

"And at page 124 of 20 Am. Bankr. Rep., and page 64 of 160 Fed.:

"Before the partnership property is placed in custodia legis for administration, it is not held in trust for the payment of the partnership creditors in preference to the creditors of the individual partners. The partnership creditors have no lien upon it, and no independent right to its application to the payment of their claims in preference to the claims of the creditors of the individual partners. * * *

"At page 125 of 20 Am. Bankr. Rep., and page 64 of 160 Fed.:

"The right of the creditors of the partnership to payment out of the partnership property in preference to the individual creditors is the mere right by subrogation or derivation to enforce this right of one of the partners after the partnership property has been placed in the custody of the law."

"There is no evidence before the referee that the withdrawals made by this claimant were made with a fraudulent or preferential intent. The amounts withdrawn, beginning with the year 1903, seem to be approximately the same amount, viz., \$20 per week in cash and sundry merchandise.

"If this were the sole objection to the claim, the claim should have been allowed; but it is judicially before the court that the claimant, at the time he made these loans to his firm, the Lerch & Rice Company, was a member of that firm, and the testimony taken on this particular objection discloses that he was a member of the firm and to the extent of 50 per cent. thereof.

"The objection filed by the Joel Bailey Davis Company does not specifically raise this point as an objection to the allowance of the claim, but does set forth the fact, and as a part of its objection, that the claim filed was based upon money loaned by the claimant to a partnership of which he was a member.

"In the opinion of the referee, this is a fatal objection to the allowance of the claim.

"The facts in this case are very like the facts in the case of *Wallerstein v. Ervin*, 7 Am. Bankr. Rep., at page 256, 112 Fed., at page 124, 50 C. C. A. 129, in which the United States Court of Appeals for the Third Circuit says:

"The moneys advanced in excess of the amount agreed to be contributed were, it is true, in many, if not in all, instances called "loans," and the merchandise supplied was no doubt regarded by the parties themselves as having been "sold"; and it may well be conceded that upon any accounting between the parties the appellant would, after satisfaction of the firm debts, be entitled to priority of credit for its surplus advances of either kind. Yet as the proof proposed would, if allowed, have reduced the fund to which the general creditors of the firm were constrained to look for the partial payment of their claims, the law imperatively required its rejection. Whatever may have been the understanding of the partners, or their respective rights, inter se, there can be no doubt that, in fact and in law, not only the \$15,000 agreed to be contributed, but also the additional money advanced and the goods supplied, were, as to creditors, embarked in the business of the firm. They augmented its capital

and enhanced its credit, and therefore could not in any manner be exempted from liability from its debts.'

"The facts appear in *Re Ervin* (D. C.) 109 Fed. 135.

"To the same effect is the case of *Rush v. Lake*, 10 Am. Bankr. Rep. 455, 122 Fed. 561, 58 C. C. A. 447; 'the only difference being that in the case of *Rush v. Lake* there was a question of fact as to whether the claimant was a partner or not, and upon the finding that he was a partner the claim against the partnership fund was rejected.

"The proposition is stated in *Re Denning* (D. C.) 8 Am. Bankr. Rep. 133, 114 Fed. 219, at page 134 of 8 Am. Bankr. Rep., and page 220 of 114 Fed., as follows:

"It is plain that the bankrupt's former partner cannot be allowed to prove in this case. To permit him to do so would permit him to compete with his own creditors. Under a separate commission like this, joint creditors may prove, and at the least they may share in the surplus of the separate estate after payment of the separate debts. There are joint creditors in this case, who have proved, and, until claims of the joint creditors are settled, Brown cannot share in the distribution of his former partner's estate.'

"The claimant loses nothing by the disallowance of his claim, because he individually is not entitled to participate until all the firm creditors and all his individual creditors are paid in full. His individual creditors lose nothing, because ample provision is made in the act itself for just such a contingency.

"Section 5f, Bankr. Act July 1, 1898, c. 541, 30 Stat. 548 (U. S. Comp. St. 1901, p. 3424), provides 'that the net proceeds of the partnership property shall be appropriated to the payment of the partnership debts, and the net proceeds of the individual estate of each partner to the payment of his individual debts. Should any surplus remain of the property of any partner after paying his individual debts, such surplus shall be added to the partnership assets and be applied to the payment of the partnership debts. Should any surplus of the partnership property remain after paying the partnership debts, such surplus shall be added to the assets of the individual partners in the proportion of their respective interests in the partnership.'

"It is hard to conceive how the proposition could be more clearly stated than the act itself states it. If, after the payment of the firm obligations, there is any fund remaining, the individual estate of *Jos. A. Rice* is entitled to 50 per cent. of such surplus and the creditors proving against his individual estate shall receive the benefit of the same. Some argument was made that section 5g controlled the allowance or disallowance of the claim in question.

"This section has been construed in *Re Henderson* (D. C.) 16 Am. Bankr. Rep. 91, at page 94, 142 Fed., at page 590:

"That partnership assets shall pay partnership debts, individual assets individual debts, and only surpluses shall be applied the one to the other; * * * nor can I read paragraph "g" as giving any excuse for the establishment of such exception by judicial construction.

"Clause "f" states the precepts of the law. Clause "g" relates to the procedure under it. The law in "f" demands that "the net proceeds shall be appropriated" as directed by it, while "g" provides simply that in carrying out these precepts, and as an aid in doing so, the court may do certain things, to wit, permit proof of claims of partnership estates against individual estates and vice versa, and marshal the assets of such estates so as to prevent preferences and secure equitable distribution of such estates. Note the use in this paragraph of the word "estate," instead of the word "debt," as used elsewhere. It is properly used, and was designated to meet such cases, as, for example, where the partnership estate might have a just claim against one of its individual members, who had not paid into the partnership his full share, or any part, of the capital which he was legally bound to do, while the other members of the partnership perhaps had done so, or, vice versa, where the individual member, a bankrupt, had paid into the partnership fund all of his pledged capital, while the other members had not. To meet such and other similar cases that might arise, I am convinced was the sole cause and scope of this permissive clause in procedure, only mandatory in cases where the circumstances in equity and good conscience required its application.'

"In the present proceeding there is no allegation or proof that the members composing the partnership did not pay in their original agreed contribution to the partnership fund, and therefore, in the opinion of the referee, section 5g does not apply."

The referee's decision is attacked on the ground that the claim of Joseph A. Rice against the firm is an asset of his individual estate, which belongs to his individual creditors, and should not be withheld from them, and thus applied in effect to the claims of other partnership creditors than himself. But this argument fails to state the situation precisely. No doubt the claim of Joseph A. Rice against the firm of which he was a member is an asset of his individual estate; but it is an asset with a particular disability, and in this respect it differs from the claims of other partnership creditors. Its disability consists in the fact that, according to the well-settled rule governing the marshaling of partnership and of individual assets, it cannot participate in the distribution of the partnership assets until other partnership creditors have been satisfied in full. For this reason the individual creditors of the claimant cannot profit by it as completely as if he were an ordinary creditor of the firm, and not a member also. But nothing is taken away from the individual creditors to which they are equitably entitled, because the claimant himself could not share in the distribution of the partnership assets *pari passu* with other partnership creditors. To sustain the claimant's position would give to his individual creditors a more extensive right against the bankrupt firm than he himself possesses, and would thus do violence to the rule that the individual creditors succeed only to such equity in the firm assets as belongs to their debtor himself. See 22 Am. & Eng. Ency. (2d Ed.) 195, note 8.

In strictness, however, the referee's order is formally incorrect. He "disallowed and expunged" the claim; whereas, if the evidence in its support was sufficient, he should have allowed it, but with the express qualification that it could not be permitted to share in the distribution of the partnership assets until such other partnership creditors as were not members of the firm also had been paid in full. Practically the form of the order does no harm, since the partnership fund is not large enough to pay such other partnership creditors in full; but if there be a contingency that sufficient partnership assets may exist, and may be realized upon, to pay the remainder of the claims belonging to those creditors and leave a surplus for the claims belonging to the individual partners themselves, it may be worth while to have the claim under consideration in a condition to share in the surplus. If, therefore, it is desired that the claim should be formally allowed, but with the qualification just stated, and if a motion to that effect be filed within five days, the proper order will be made. In default of such motion, the clerk is directed to make an entry affirming the order of the referee.

In re RICE et al.

(District Court, E. D. Pennsylvania. October 14, 1908.)

No. 3,000.

In Bankruptcy. On certificates of referee concerning claims of Robert N. Weaver.

Robert S. Siegel, for claimant.

J. Howard Reber and Maxwell H. Kratz, for objecting creditors.

J. B. McPHERSON, District Judge. These certificates present for review two orders disallowing and expunging claims of Robert N. Weaver against the firm's bankrupt estate of \$1,001.50 and \$3,400, respectively. The claimant was also a member of the bankrupt firm, and his claims stand upon the same footing as the claim of Joseph A. Rice, which has been considered and disposed of in an opinion filed herewith. 164 Fed. 509.

For the reasons there given, it is ordered, with reference to the two claims now before the court, that if it be desired to have these claims, or either of them, formally allowed, but with the qualification there stated, and if a motion to that effect be filed within five days, the proper orders will be made. In default of such motion, the clerk is directed to make an entry affirming the orders of the referee.

 In re RICE et al.

(District Court, E. D. Pennsylvania. October 15, 1908.)

No. 3,000.

BANKRUPTCY (§ 164*)—PROVABLE CLAIMS—SURRENDER OF PREFERENCE.

Payments made to a creditor by a partnership within a few days prior to its bankruptcy *held*, under the evidence, to constitute voidable preferences, which the creditor was required to repay before proving a claim against the estate.

[Ed. Note.—For other cases, see Bankruptcy, Cent. Dig. § 267; Dec. Dig. § 164.*]

In Bankruptcy. On certificate of referee concerning claim of E. O. Dech.

William E. Doster and Ralph B. Evans, for claimant.

J. Howard Reber and Maxwell H. Kratz, for objecting creditors.

J. B. McPHERSON, District Judge. This controversy is over an order of the referee directing that no dividend out of the assets of the Lerch & Rice Company should be paid upon the claim of E. O. Dech unless he should repay to the trustee, within 10 days, the sum of \$830.09, being the aggregate of six preferential payments made to him by the bankrupt firm within a few days before the petition was filed. The dispute is wholly of fact, and, without discussing the evidence in detail, I shall only say that I have read with attention the notes of testimony accompanying the report of the referee and that I agree with his findings, namely:

*For other cases see same topic & § NUMBER in Dec. & Am. Digs. 1907 to date, & Rep'r Indexes

"(1) That the Lerch & Rice Company, bankrupt, was insolvent for a period at least antedating December 30, 1907.

"(2) That Mr. Lerch and Mr. Rice, members of the firm, knew on December 30, 1907, and on January 2, 1908, that the firm of the Lerch & Rice Company was insolvent.

"(3) That the payments made to Ezra O. Dech on December 30, 1907, and January 2, 1908, were made with the intent to give Mr. Dech a preference over other creditors of the same class.

"(4) That Mr. Dech, the claimant, had reasonable cause to believe that the firm of the Lerch & Rice Company was insolvent on and after December 30, 1907, and that, by receiving said payments, he was receiving a preference."

It follows that the order of the referee was correct, and it is now affirmed, with the modification that the claimant be allowed the further period of five days from the date of filing this opinion within which to make repayment in cash of the sum of \$830.09 to the trustee of the bankrupt firm.

In re CALDWELL.

(District Court, E. D. Arkansas, W. D. October 17, 1908.)

No. 956.

BANKRUPTCY (§ 348*)—DEBTS ENTITLED TO PRIORITY—WAGES OF "SERVANT."

Musicians, employed at regular wages to play in a theater or other place, are "servants," within the meaning of Bankr. Act July 1, 1898, c. 541, § 64b (4) 30 Stat. 563 (U. S. Comp. St. 1901, p. 3447), and entitled to priority of payment from the estate of the employer in bankruptcy for their wages earned within three months.

[Ed. Note.—For other cases, see Bankruptcy, Dec. Dig. § 348.*

For other definitions, see Words and Phrases, vol. 7, pp. 6422-6429; vol. 8, p. 7798.]

In Bankruptcy.

Downie, Rouse & Streepey, for petitioners.

J. A. Comer, for trustee.

TRIEBER, District Judge. The only question involved in this proceeding is whether the petitioners, to whom wages are due for services rendered within three months of the institution of the bankruptcy proceedings as musicians, hired by the bankrupt to play on his roof garden, are entitled to priority under section 64, cl. 4b, of the bankruptcy act (Act July 1, 1898, c. 541, 30 Stat. 563 [U. S. Comp. St. 1901, p. 3447]). To decide this question requires the determination of the meaning of the word "servant" in that section, for it is conceded that the petitioners are neither workmen, clerks, nor salesmen.

While lexicographers define the word differently, the Century Dictionary defining it as "one who exerts himself or labors for the benefit of a party or employer; an attendant; a subordinate assistant"—the courts have not considered themselves bound by the definitions found in dictionaries, but have construed the word so as to carry into effect the intent of the lawmakers. In *Cawood v. Wolfley*, 56 Kan. 281, 43 Pac. 236, 31 L. R. A. 538, 54 Am. St. Rep. 590, the court was called upon to construe the words "wages of servants," in a statute regulat-

*For other cases see same topic & § NUMBER in Dec. & Am. Digs. 1907 to date, & Rep'r Indexes

ing the classification and priorities of demands against estates of deceased persons—i. e., whether, as in the case at bar, a clerk in a store was a servant, entitled to priority of payment—and it was held that such a person was a “servant,” within the meaning of the statute. The court in its opinion said:

“The Legislature by the enactment has manifested a purpose to secure all wage earners their hire, and to prefer their claims to any other creditors. It is conceded that the term ‘servant’ in its usual application, especially in the law, is broad enough to include a clerk; but it is argued that the word is here used in a restricted sense, and means only menial or household servants. We are loath to recognize any such classification as ‘menial servants.’ The word is broad enough to include a clerk, and we think the Legislature intended to do so.”

In *Frank & Dugan v. Herold*, 63 N. J. Eq. 445, 52 Atl. 155, it was held that skilled operators employed in a manufacturing establishment are “servants.” The Vice Chancellor, in his opinion, said:

“Now, I say that the relation of master and servant existed between plaintiff and these operators. I do not use the word ‘servant’ in any menial sense. Any person who works for another for a salary is a servant in the eye of the law; and in the law the relation of master and servant does not necessarily include anything menial or degrading.”

A definition of the word, which is very comprehensive and meets my views as to its legal meaning, is that given in 20 A. & E. Enc. of Law (2d Ed.) 11:

“A servant is one who is employed to render personal services to his employer otherwise than in the pursuit of an independent calling, and in any such service remains entirely under the control and direction of the latter.”

And on page 12, where it is said:

“The relation of master and servant exists where the employer has the right to select the employé, the power to remove or discharge him, or the right to direct both what work shall be done and the way and manner in which it shall be done.”

The bankruptcy act, while primarily intended to secure an equal distribution of the assets of the bankrupt among his creditors, evinces a strong intent on the part of Congress to protect those who are dependent on their daily earnings for their support, and gives them a preference over ordinary creditors, limiting it to three months’ wages. As to the limitation of three months, it was no doubt influenced by the fact that persons who permitted their wages to accumulate for a longer period of time are not in as needy condition as the ordinary wage earner. The act as originally passed included only “workmen, clerks and servants.” When Congress found that some of the courts, giving that provision of the act a strict construction, had held that a traveling salesman was not within the classes mentioned (*In re Scanlan* [D. C.] 97 Fed. 26; *In re Greenwald* [D. C.] 99 Fed. 705; *In re Mayer* [D. C.] 101 Fed. 227), it amended the act so as to avoid that construction by adding the words “traveling or city salesmen.” Act June 15, 1906, c. 3333, 34 Stat. 267 (U. S. Comp. St. Supp. 1907, p. 1033).

It is true that Congress might have added the word “wage earner,” and thus removed all doubt; but it was probably thought that the word “servant,” in view of the construction given to the word by the

courts generally, was sufficiently broad to include all persons working for the benefit of a master or employer and dependent upon wages for their support. Employés of carriers, mills, and other establishments are always designated as servants, and the employers as masters. A musician, employed by the day, week, or month at regular wages, while not a "menial servant" in any sense of the word, is still one who labors for the benefit of an employer. He is not in pursuit of an independent calling, and is subject to his master's commands, and must do as directed. The fact that his work is that of an artist does not deprive him of the benefit which the law intended to give to those working for wages for their living. An artist of the highest class might be employed to do some fresco painting at daily wages. Should the fact that he is an artist deprive him of any rights under that provision of the bankruptcy act, although his work is performed as a hired employé?

I do not think the intent of Congress was so narrow, but rather that it took the broad view that every laborer, clerk, servant, or employé working for wages for the benefit of a master or employer, when such wages furnish the means of his livelihood, and where the relationship of master and servant exists within the well-known meaning of the law, shall have priority over ordinary creditors for the sum due him for such services, not to exceed three months' wages. Any other construction would do a great injustice to a large class of wage earners, to whom their daily earnings are absolutely necessary for their support and that of their families—an injustice which I am not inclined to assume Congress intended to inflict on them. The priorities provided for by the bankruptcy act are remedial, and should be liberally rather than strictly construed. As has been well said:

"All laws should receive a sensible construction. General terms should be so limited in their application as not to lead to injustice, oppression, or an absurd consequence. * * * The reason of the law in such cases should prevail over its letter." *United States v. Kirby*, 7 Wall. 482, 486, 19 L. Ed. 278; *Holy Trinity Church v. United States*, 143 U. S. 457, 461, 12 Sup. Ct. 511, 36 L. Ed. 226; *Lau Ow Bew v. United States*, 144 U. S. 59, 12 Sup. Ct. 517, 36 L. Ed. 340.

Applying these rules, I am of the opinion that musicians, employed at regular wages to play in a theater or any other place, are "servants," within the meaning of section 64, cl. 4b, of the bankruptcy act, and petitioners are entitled to priority of payment.

In re EVENING STANDARD PUB. CO.

(District Court, N. D. New York. October 29, 1908.)

BANKRUPTCY (§ 123*) — ELECTION OF TRUSTEE — VACATION—FAILURE TO NOTIFY CREDITOR.

Where the District Court, in sustaining a petition in involuntary bankruptcy and ordering an adjudication after a contest, expressly determined that one participating in the proceedings and claiming to be a creditor was entitled to file his proof of claim and to be treated as a creditor, unless his claim should be rejected after hearing in the regular way, he was en-

*For other cases see same topic & § NUMBER in Dec. & Am. Digs. 1907 to date, & Rep'r Indexes

titled to notice of the first meeting of creditors for the election of a trustee, although not scheduled as a creditor by the bankrupt, and to attend and file his claim and to participate in the meeting, unless duly verified objection was made to his claim by a creditor, in which case it was the duty of the referee either to adjourn the meeting until the matter could be tried, or in the exercise of a sound discretion to appoint a trustee; and where he was not notified of the meeting, and a trustee was elected and the election confirmed without his knowledge, and on his appearing and filing his claim at an adjourned meeting it was objected to by the trustee, and he was denied any participation in the meeting, the election will be vacated and a new meeting ordered, at which such claiming creditor may be given the same right to participate as others making similar claims.

[Ed. Note.—For other cases, see Bankruptcy, Dec. Dig. § 123.*]

In Bankruptcy. This is an appeal from and review of the action of the referee in confirming the selection, at the first meeting of creditors, of Charles W. Hill as trustee; also a motion to remove the trustee or set aside his appointment.

Frank H. Deal, for trustee.

J. A. Cipperly, for objecting creditor.

RAY, District Judge. On the question whether or not the above-named Evening Standard Publishing Company had committed an act of bankruptcy and was insolvent and should be adjudicated a bankrupt there was a contest before Edwin A. King, to whom the matter was referred as special master. He held and reported that the company was insolvent, that the act of bankruptcy charged had been committed, and that the petitioners were creditors. William J. Tyner was an alleged creditor, who as such interposed an answer in that matter and opposed adjudication. The special master held that Tyner was not a creditor of the Evening Standard Publishing Company and that he had no standing as a creditor to oppose the adjudication.

On review and motion to confirm this court held that the proceeding for adjudication was properly instituted, that the act of bankruptcy had been committed as alleged, and affirmed and approved the action of the special master in those regards, and ordered an adjudication accordingly. This court, however, expressly disapproved the finding that William J. Tyner was not a creditor of the alleged bankrupt, Evening Standard Publishing Company, and refused to confirm in that regard, and held that in the further proceedings in the case William J. Tyner should be regarded and treated as a creditor until it should be determined that he was not; that he should be allowed to prove and present his claim for allowance, and, if objected to, have it tried out before the referee, to whom the matter should be referred on the merits. Referee King was the special master above named. On adjudication pursuant to the order of this court being made, the matter was duly referred to Referee King. The attorney for the moving parties had a copy of the opinion of this court. It must be presumed that Special Master (and hence Referee) King had notice of the decision of this court.

Thereupon a first meeting of creditors was called, at which a trustee was to be elected. The decision and order of this court as to the

*For other cases see same topic & § NUMBER in Dec. & Am. Digs. 1907 to date, & Rep'r Indexes

status and rights of William J. Tyner were disregarded, no attention was paid thereto, and Tyner was ignored and not notified of the first meeting of creditors, which was held September 26, 1908, and, having no knowledge of it, did not attend or present his claim to the referee for allowance or have any part in the proceedings. Thereupon, at that meeting, Charles W. Hill, a most estimable man, was appointed trustee by the creditors there represented, and this appointment was confirmed by the referee. Hill qualified the same day and was authorized to sell the assets of the bankrupt October 6, 1908, and the first meeting of creditors was adjourned to October 7, 1908. On October 5, 1908, Tyner, having heard of the proposed sale and adjourned meeting, filed with the referee a claim as creditor for \$4,716.26 and a petition setting forth that he had no notice of the first meeting of creditors, praying that the proof and allowance of the claim of one William Connors for \$14,401.84, much more than a majority in amount of all the claims proved and allowed, be expurged, denying its validity, and also praying that the proposed sale be postponed, etc. His requests were all denied. On the 7th Tyner appeared at the adjourned meeting, but the sale was confirmed. Tyner's claim was objected to by the trustee, of course, and thus he was eliminated from any real participation in the matter. The assumption of the referee and attorneys for the trustee and others, in not notifying Tyner of the first meeting, was that, as he was not scheduled by the bankrupt corporation as a creditor, he was not entitled to notice; but they had notice that he claimed to be a creditor, and that the court had decided that, until his claim was presented in the regular way and offered for allowance and disallowed, he was to be treated as a creditor or alleged creditor. He was entitled to notice of the first meeting of creditors, and entitled to attend and file his claim. If his claim was not then objected to by a creditor and valid on its face, he was entitled to have it allowed, and then to take part in the selection of a trustee. If objected to by creditors, and such objections were verified, then it was the duty of the referee either to adjourn the meeting and try out the merits of the claim, or, if that would unduly postpone the election of a trustee, to proceed on the votes of those whose claims were allowed. Tyner had the right at the first meeting as an alleged creditor to file verified objections to the claims of other alleged creditors. The whole tenor of the argument of counsel for the trustee is that, if Tyner had been notified and allowed to come in at the first meeting, he would have unduly postponed the election of a trustee and the administration of the estate; but such was not the necessary consequence. Whether the referee will or will not postpone the election of a trustee, where claims are objected to, is a matter of sound discretion. If such a number of claims are duly objected to that an election by a majority in number and amount cannot be had, then, if circumstances demand, he may and should himself appoint. All this is settled by the weight of well-considered authorities.

Claims should not be voted where duly verified legal objections are filed thereto. Of course, the referee may proceed to take proof, and, if the objecting party cannot produce sufficient evidence to sustain them, he will allow the claim. If the objecting party shows legal cause

for delay for the purpose of producing evidence not at hand, the referee may in some cases allow the claim for voting purposes; but a better practice is to proceed to an election on the allowed claims, if the condition of the estate demands prompt action. If so many verified objections, apparently valid, are filed that an election by creditors is impossible, let the referee appoint. This court will not assume that Tyner's claim would or would not have been objected to. It will not assume he could not then and there have sustained it by ample proof. It will not assume that Tyner's presence and statements would not have changed the attitude of the creditors present and voting. He had the right to be notified, so as to attend and be heard. What is certain is that this court had decided that Tyner should be treated as a person claiming to be a creditor, with a right to present his claim at the first meeting of creditors, and, as an alleged creditor, be allowed to participate in the proceedings as such, and to the extent such a creditor is allowed recognition. The order of the court was disregarded, and Tyner's rights to some extent prejudiced. That he may have his day in court, a fair hearing, and a proper notice, there will be an order vacating and setting aside the proceedings had at the first meeting of creditors and declaring that meeting void, setting aside and vacating the alleged election of a trustee and the order appointing him or confirming his election or appointment, and also directing that the referee call a meeting, giving due notice to all alleged creditors, including Tyner, for the purpose of electing a trustee and transacting such business as may be legally done at such a meeting. The sale made by the trustee may stand, and the proceeds be paid into court. If made to appear hereafter that the sale was for an inadequate consideration, it may be set aside, and a new sale ordered.

It is perhaps unnecessary to add that what has been said is in no way a reflection upon the good faith of the referee and attorney for the moving parties, as they proceeded on the theory that, even in such a case as this, only scheduled creditors are entitled to notice.

UNITED STATES v. ROGERS.

(District Court, W. D. Kentucky. October 23, 1908.)

1. CRIMINAL LAW (§ 951*)—NEW TRIAL—TIME FOR MAKING APPLICATION.

The setting aside of a verdict and granting of a new trial by a federal court in a criminal case is not governed by any statute, but is a matter of discretion, which may be exercised at any time before judgment has been entered on the verdict, although the term at which the verdict was returned may have passed.

[Ed. Note.—For other cases, see Criminal Law, Cent. Dig. §§ 2349-2352; Dec. Dig. § 951.*]

2. INTERNAL REVENUE (§ 47*)—PROSECUTION FOR FAILURE TO REMOVE STAMP FROM EMPTIED LIQUOR BARREL—SUFFICIENCY OF EVIDENCE.

The conviction of a defendant of a violation of Rev. St. § 3324 (U. S. Comp. St. 1901, p. 2168), by failing to remove the stamp from a barrel which contained distilled spirits when such barrel was emptied, which constitutes a felony, and requires the imprisonment of the defendant in

*For other cases see same topic & § NUMBER in Dec. & Am. Digs. 1907 to date, & Rep'r Indexes

the penitentiary for a term of not less than one year, will not be sustained on evidence that, on the sale of a single barrel by defendant, he expressly directed an employé to empty it of the liquor remaining therein and to destroy the stamp before delivering the barrel to the purchaser, and that the failure of the employé to obey such order was unknown to him.

[Ed. Note.—For other cases, see Internal Revenue, Dec. Dig. § 47.*]

On Motion for New Trial.

Geo. Du Relle, U. S. Atty.

W. M. Smith, for defendant.

EVANS, District Judge. The indictment charges that the defendant, at the time of emptying a certain cask or package of distilled spirits, did, with intent to cause or procure to be transported such empty cask, fail to efface and obliterate the marks, stamps, and brands thereon, in violation of section 3324 of the Revised Statutes (U. S. Comp. St. 1901, p. 2168). A verdict of guilty was returned by the jury in the case on October 16, 1907. Upon motion of the defendant, acquiesced in by the district attorney, the court from time to time postponed entering a judgment upon the verdict in order to give an opportunity for an application for a pardon. In view of the great hardship of the case, this delay was granted without reluctance, especially as no motion for a new trial was made. Nor had the defendant at the trial asked the judgment of the court upon the sufficiency of the evidence to authorize a conviction. At this term—two terms having expired since the verdict of the jury was returned—upon written grounds therefor the defendant moved the court to set aside the verdict and grant a new trial.

Two terms having elapsed, the question arises as to the power of the court to act upon the motion thus made. Certainly, if final judgment had been pronounced at the October term, 1907, the power of the court over it would have ceased with that term, in March, 1908. But, as no judgment was then rendered, the question is: Did the court lose control over the action of the jury when that term ended. The practice act, now section 914 of the Revised Statutes (U. S. Comp. St. 1901, p. 684), relates exclusively to civil actions at common law, and not to either equity or criminal causes. Section 987 of the Revised Statutes (U. S. Comp. St. 1901, p. 708) authorizes a motion or petition for a new trial to be presented within 42 days after the judgment; but that section also, in express terms, applies only to civil actions. The statutes of the United States in no way fix or prescribe any time within which a motion for a new trial may be entered in criminal cases. The laws of the several states as to new trials in criminal cases in no way regulate or control the federal courts. At the common law we think the right to ask the court not to render judgment upon a verdict in a criminal case, but to order another trial thereof, existed until judgment on the verdict was rendered, and in some cases until the close of the term even after judgment. Nothing is better settled than that the granting of a new trial by the federal courts is matter of discretion, and this discretion may, we think, be exercised as long as the matter is *in fieri*. The mere return of the verdict is in a certain

*For other cases see same topic & § NUMBER in Dec. & Am. Digs. 1907 to date, & Rep'r Indexes

sense an interlocutory matter, and, this being true, it is always, like other interlocutory matters, within the power of the court until after final judgment. Indeed, a verdict is ineffectual without a judgment, and except to support a plea of former acquittal or as the basis of a judgment is without force.

Upon these considerations, which might be amplified, we conclude that the verdict in this case is yet subject to the power of the court, either to render judgment upon it or to set it aside upon a motion either in arrest of judgment or for a new trial.

Having concluded that we have power over the verdict, we must consider the merits of the motion for a new trial, which motion, in general terms, is based upon the proposition that the verdict was not sustained by the evidence. At the trial the testimony showed the facts to be substantially as follows:

Rogers and a colored man, who had been in his employ for a number of years, testified that Rogers kept his stock of liquor in his barroom in the original packages upon the opposite side of the barroom from the bar; that, in order to protect the stamps upon these barrels from defacement before the barrels were emptied, it was his habit to tack a piece of light board over the stamp upon the end of the barrel; that the barrel in question was nearly empty when Peter Bitzer came there and asked if there were any empty barrels for sale. Rogers sold this barrel to Bitzer, saying he would have it emptied when it was sent for. Rogers and his colored man both testified that Rogers had given precise and careful instructions to the latter to destroy the stamps upon all barrels that were empty and sold. Another colored man in the employ of Bitzer, who had died before the trial, came with a wagon for the barrel. Rogers directed his man to empty it. He did so, and immediately removed the board upon the end of the barrel, and was about to take off and destroy the stamp, and had actually, as he testified, pulled up one corner of the stamp for that purpose when Bitzer's man told him to stop, and said the stamp was not to be taken off. He thereupon replaced the corner of the stamp and tacked the board on again, and Bitzer's man took it away in his wagon. When Bitzer's place was raided, soon after, and he was found to be running an illicit distillery in the city under the guise of a vinegar factory, this barrel was found with the stamp intact, and was traced through the distillery records back to Rogers.

The statute upon which the indictment is based makes the offense a felony, and requires the court, after conviction, to impose a sentence of not less than one year in the penitentiary and a fine of not less than \$500. Where the facts of a case are such as have just been stated, the court is not content to impose such a sentence, but is clearly of opinion that the motion for a new trial ought to be sustained.

Accordingly the verdict of the jury will be set aside, and a new trial of the case ordered.

GROOM v. WITTMANN et al.

(Circuit Court, D. New Jersey. October 24, 1908.)

EQUITY (§ 150*)—PLEADING—MULTIFARIOUSNESS OF BILL.

A bill in equity against a corporation and another, one purpose of which is to establish complainant's equitable interest in certain lands the title to which is in the corporation and to recover such interest, and another to recover damages from the other defendant for breach of a contract to which the corporation is not a party, and in which it has no interest, is demurrable for multifariousness.

[Ed. Note.—For other cases, see Equity, Cent. Dig. §§ 342, 371; Dec. Dig. § 150.*]

In Equity. On demurrer to bill.

David W. Armstrong, for complainant.

R. V. Lindabury, for defendant Mortimer Land Co.

LANNING, District Judge. The causes of demurrer specified by the defendant the Mortimer Land Company are multifariousness and want of equity in the bill of complaint. The complainant seeks to secure by his bill a decree adjudging that a tract of land in Texas, of 25,280 acres, the legal title to which is vested in the Mortimer Land Company, is held by that company in trust for the equal benefit of the complainant and the defendant Mrs. Eleanor C. Wittmann, and also adjudging that the complainant is entitled to an accounting by Mrs. Wittmann of the profits, of which he alleges he has been deprived by the failure of Mrs. Wittmann's testator to purchase a second tract of 30,720 acres of land lying contiguous to the above-mentioned tract of 25,280 acres. The ground upon which the decree is sought is an oral contract made in 1897 by the complainant and Mrs. Wittmann's testator, the purport of which was (1) that Mrs. Wittmann's testator would purchase all the capital stock of the Mortimer Land Company, except what was then owned by the complainant and Mrs. Wittmann's testator; (2) that he would purchase the second tract of land above referred to; (3) that the complainant should develop both tracts; and (4) that after the moneys advanced by Mrs. Wittmann's testator had been refunded, with interest, the land in the two tracts and all profits of the business should be equally divided between the complainant and Mrs. Wittmann's testator. Other relief is prayed for by the bill, which it is not now necessary to mention.

It is conceded that the Mortimer Land Company is a stranger to the oral contract, and that it has no interest, direct or indirect, in the second tract of land. The situation is this: The complainant alleges that Mrs. Wittmann's testator did in fact purchase the capital stock of the land company which by the oral contract of 1897 he agreed to purchase, but that, although he secured an option for the purchase of the second tract of land, which continued for several years, and although the complainant entered upon both tracts and spent several years in developing them, Mrs. Wittmann's testator finally allowed the option for the purchase of the second tract to expire without exercising his right of purchase. The complainant therefore insists that by

*For other cases see same topic & § NUMBER in Dec. & Am. Digs. 1907 to date, & Rep'r Indexes

virtue of the provisions of the oral contract he should have a decree adjudging, first, that he is entitled to one-half of the lands of the land company; and, second, that Mrs. Wittmann should pay him a sum equal to the profits he would have realized if Mrs. Wittman's testator had purchased the second tract of land. Here, then are two separate and distinct claims; one arising out of an alleged equitable interest in the tract of land, the title to which is vested in the land company, and the other being a claim for damages for breach of the oral contract by Mrs. Wittmann's testator's failure to purchase the second tract.

Assuming that the former of these two claims may be adjudicated, and that the corporation may be stripped of its property, without regard to the claims of its creditors, if it has any, and in the absence of a proceeding intended to wind up its affairs, and assuming, too, that equity had jurisdiction of the latter of the claims, they are clearly claims that, if they be enforceable at all, are enforceable in separate proceedings. While the fact that a bill embodies claims that may be enforced in separate suits is not, in and of itself, sufficient to uphold the defense of multifariousness, it is sufficient where it also appears that they are so separate and distinct in their natures that they cannot be united in one general object. This principle is well established by the authorities cited in the briefs of both counsel. In the case in hand the land company contends, by its demurrer, that it ought not to be required to defend a suit one object of which is to strip it of its lands, on the ground of the complainant's alleged equitable interest therein, and the other of which is to recover damages against another party for the breach of a contract to which the land company is not a party and in which it has no interest. While no hard and fast rule can be given for distinguishing between bills that are and those that are not multifarious, I have been referred to no case where claims so utterly unrelated, and so incapable of being brought together for the enforcement of one general right, have been permitted to stand together in a single bill.

Without considering the objection that the bill is bad for want of equity, there will be an order sustaining the demurrer on the ground of the multifariousness of the bill.

UNITED STATES v. STAMATOPOULOS et al. (three cases).

UNITED STATES v. VARNAVELIAS et al.

(Circuit Court, E. D. New York. May 6, 1908.)

Nos. 746, 756, 766, 767.

1. CONSPIRACY (§ 43*)—CUSTOMS DUTIES—CRIMINAL LAW—SUFFICIENCY OF INDICTMENT.

An indictment under section 5440, Rev. St. (U. S. Comp. St. 1901, p. 3676), for conspiracy to defraud the United States by means of a false invoice, is sufficient which sets forth such a conspiracy, notwithstanding that it does not set forth the consummation of the fraud nor include an allegation that the fraud could have been accomplished, if not detected.

[Ed. Note.—For other cases, see Conspiracy, Cent. Dig. § 97; Dec. Dig. § 43.*]

2. CONSPIRACY (§ 43*)—INDICTMENT—SUFFICIENCY—PARTICULARITY OF ALLEGATION.

An indictment for conspiracy to defraud the United States by a false invoice is not vitiated by the particularity with which the overt act is set forth, if the conspiracy of itself be sufficient.

[Ed. Note.—For other cases, see Conspiracy, Cent. Dig. § 97; Dec. Dig. § 43.*]

On Demurrer to Indictments for Criminal Conspiracy.

The defendants in these cases are "Stephen" D. Stamatopoulos (name Stephen fictitious), Simon G. Mescall, Patros Varnavelias, Pant Vulgaris, Simon J. Mescall, and Stamatis D. Stamatopoulos.

William J. Youngs, U. S. Atty.

Eugene F. O'Connor, Jr. (Leo Oppenheimer, of counsel), for defendant Mescall.

Charles W. Gould, for defendant Stamatopoulos.

CHATFIELD, District Judge. These indictments are similar in their allegations and are brought to charge an offense within the provisions of section 5440, Rev. St. (U. S. Comp. St. 1901, p. 3676). In general, the charge set forth in each indictment is a conspiracy to defraud the United States by returning false weights to the officers of the customs service upon certain importations of cheese, which the indictments allege were to be imported into the United States and entered by means of a false invoice, and with the statement of a smaller quantity or weight of cheese in the entry blank than the actual weight of the importation. The indictments further set forth that the false weight to be returned by the weigher, who is one of the defendants named in the indictment, was the weight upon which the amount of duty would be finally estimated, and that it was planned and intended to defraud the United States of a part of the revenue; i. e., the difference. Each indictment then proceeds to recite an overt act in the form of a specific statement of an importation entry and return of a weight less than the true amount.

A demurrer has been interposed to each of these indictments, and a number of grounds of demurrer have been set forth; but it is considered that none of these grounds of objection is sufficient. The indictments set forth a conspiracy to defraud the United States, and it is unnecessary to allege either the consummation of the fraud or to include an allegation that the fraud could have been accomplished unless detected. It is sufficient to show that the conspiracy was to do an act which would constitute a fraud upon the United States.

The further objection raised by the demurrers that the conspiracy alleged is a conspiracy to commit the overt act is not well founded. Briefly stated, this objection is that the overt act is stated with particularity enough to constitute a fraud upon the revenue of the United States and to define an offense against certain of the Revised Statutes, and the charge of conspiracy is a mere general allegation of a plan to commit the overt act. A reading of the indictment does not show this to be so. The conspiracy charged is a plan to defraud, not to commit an offense; and the particularity with which the overt

*For other cases see same topic & § NUMBER in Dec. & Am. Digs. 1907 to date, & Rep'r Indexes

act is set forth cannot vitiate the indictment, if the conspiracy of itself be sufficient.

The demurrers will be overruled.

In re PFAFFINGER.

(District Court, W. D. Kentucky. October 26, 1908.)

1. BANKRUPTCY (§ 143*)—PROPERTY PASSING TO TRUSTEE—LIFE INSURANCE POLICIES.

Where policies of insurance on the life of a bankrupt were payable to his wife, they did not pass to his trustee in bankruptcy because of the fact that by their terms the bankrupt was authorized to change the beneficiary with the consent of the company, nor because, after the bankruptcy, he applied in his own name for their surrender value, which the company did not pay him.

[Ed. Note.—For other cases, see Bankruptcy, Cent. Dig. § 201; Dec. Dig. § 143.*]

2. BANKRUPTCY (§ 143*)—EXEMPTIONS—KENTUCKY STATUTE.

Under Ky. St. 1903, § 655, which provides that a lawful beneficiary designated in a life insurance policy, other than the insured or his legal representatives, shall be entitled to the proceeds thereof as against the creditors or representatives of the insured, a policy on the life of a bankrupt, payable to his wife, does not pass to his trustee in bankruptcy.

[Ed. Note.—For other cases, see Bankruptcy, Dec. Dig. § 143.*]

In Bankruptcy. On review of orders of referee.

Joseph E. Conkling, for bankrupt.

EVANS, District Judge. This case is now before us upon a petition for a review by the court of the orders of the referee in respect to the surrender value of two policies of insurance on the life of the bankrupt, in each of which his wife, Blanche J., was made the beneficiary. One of the policies was for \$3,000 and the other for \$1,000. Each was dated November 20, 1899, each was issued by the Mutual Life Insurance Company of Kentucky, and each contained a clause authorizing the insured at any time to change the beneficiary with the consent of the company. The judgment of the referee was to the effect that the trustee was entitled to the surrender value. The question arising is an interesting one; but we have reached the conclusion that the referee was in error in the ruling sought to be reviewed.

1. As appears from the record, Pfaffinger was adjudicated a bankrupt on January 9, 1907. The bankrupt, more than a year thereafter, applied in his own name for the surrender value of the policies. The referee construed this act to be a designation of himself as the beneficiary in lieu of his wife, and there might be plausibility in the proposition if the company had consented; but that consent was never given nor obtained. There is no claim that the bankrupt in fact so intended, but at all events the designation was never completed by the company's consent, and therefore never took place, and left the rights of the beneficiary as fixed in the policies.

*For other cases see same topic & § NUMBER in Dec. & Am. Digs. 1907 to date, & Rep'r Indexes

2. The rights, if any, of the trustee accrued upon the adjudication. That fact alone would seem to exclude any right in the trustee; his right being limited as a general rule to those which existed when the adjudication was made.

3. But of still more importance is the fact that section 655 of the Kentucky Statutes of 1903, among other things, contained the following provision, to wit:

"When a policy of insurance is effected by any person on his own life, or on another life in favor of some person other than himself, having an insurable interest therein, the lawful beneficiary thereof, other than himself or his legal representatives, shall be entitled to its proceeds against the creditors and representatives of the person effecting the same."

This statute in express terms exempts just such policies, as these from liability to the demands of creditors. The opinion of the Supreme Court in *Holden v. Stratton*, 198 U. S. 202, 25 Sup. Ct. 656, 49 L. Ed. 1018, appears to leave nothing more to be said as to the proper construction of sections 6 and 70 of the bankruptcy act (Act July 1, 1898, c. 541, 30 Stat. 548, 565, 566 [U. S. Comp. St. 1901, pp. 3424, 3451]), in connection with section 655 of the Kentucky Statutes of 1903. That opinion gives to the Kentucky statute controlling influence in cases like this. Furthermore, in *Lockwood v. Exchange Bank*, 190 U. S. 294, 23 Sup. Ct. 751, 47 L. Ed. 1061, the Supreme Court held that the title to exempt property never passes to the trustee, and we think the surrender value in this case did not pass to that officer.

For these reasons, the orders of the referee will be reversed and set aside.

BOARDMAN v. HANNA.

(Circuit Court, S. D. New York. May 12, 1908.)

BILLS AND NOTES (§ 296*)—FORGED INDORSEMENT OF CHECK—LIABILITY OF BANK ON GUARANTY OF INDORSEMENT.

Plaintiff's assignor, a bank, discounted for one M. a note made by a third person, payable to his own order and indorsed by him, giving M. a check for the proceeds on itself, payable to the order of the maker of the note. M. indorsed the check with the payee's name, by himself, and delivered it to defendant bank, which also indorsed it, expressly guaranteeing the indorsements, and the discounting bank, relying on such indorsement, paid it. In fact M. had no authority to indorse the check, and did so without the knowledge or consent of the payee; and he also discounted the note without authority and in violation of his agreement with the maker. *Held*, that since the discounting bank, having paid its check on a forged indorsement, did not become a bona fide purchaser for value of the note, and could not, therefore, enforce it against the maker, plaintiff was entitled to recover from defendant upon its indorsement of the check.

[Ed. Note.—For other cases, see Bills and Notes, Cent. Dig. § 670; Dec. Dig. § 296.*]

At Law.

F. J. Hatch & Sheehan, for plaintiff.

Thomas E. Wing, for defendant.

*For other cases see same topic & § NUMBER in Dec. & Am. Digs. 1907 to date, & Rep'r Indexes

LACOMBE, Circuit Judge. There is no reason to go into any of the alleged equities, nor to inquire what may or may not be recovered upon accounting between the parties and other persons. This is an action at law, and its disposition upon the undisputed facts seems reasonably plain. On May 6, 1907, the Mercantile National Bank made a check upon itself, directing the payment of \$100,000 by itself to one Morgan J. O'Brien, or his order, and delivered said check to one Charles W. Morse. Thereafter, and on the same day, Morse indorsed said check in the name of O'Brien ("Morgan J. O'Brien, per C. W. Morse") and delivered the same to the National Bank of North America. This indorsement was made without the knowledge or consent of O'Brien, and Morse was not the agent of O'Brien for the purpose of such indorsement and was not authorized by said O'Brien to make the indorsement. Thereafter the National Bank of North America indorsed said check, specifically guaranteeing the indorsements, and presented it for payment through the New York Clearing House to the Mercantile National Bank. The latter bank, without knowledge that the indorsement by Morse in the name of O'Brien was unauthorized, and relying on the guarantee, paid the check to the Bank of North America.

The check was delivered as the proceeds of a note for the same amount, made by O'Brien to his own order and indorsed by him, dated April 22, 1907, and payable in six months. Discount was requested by Morse, who offered the note and received the check. The note had been delivered by O'Brien to Morse under an agreement between them that Morse should retain the same in his possession and renew at maturity, which agreement was in full force and effect. The discount was made without the knowledge or consent of O'Brien, and Morse was not his agent for the purpose of procuring such discount, and was not authorized by O'Brien to discount the note or to receive the proceeds. The note matured on October 22, 1907, and was not paid. The situation was then as follows: Despite the agreement between Morse and O'Brien the note would be a valid obligation against the latter, if the Mercantile Bank could show that it was a bona fide holder for a valuable consideration. That could not be shown by merely proving that it had given its check upon itself to the order of O'Brien for the amount. It would have to prove that such check was duly paid. This it could not prove, because it had not paid the check to O'Brien or his order. Therefore it must fail to recover on the note, and would be a loser to the amount of the \$100,000, which it had paid on the check to persons who did not represent O'Brien and whom he had never authorized to collect the same. That loss had resulted, however, because the Mercantile Bank relied upon the guaranty of prior indorsements signed by the Bank of North America, to which it paid the money; and against this latter bank it had a good cause of action.

This cause of action it assigned to the plaintiff on November 15, 1907, and the latter, upon the testimony here taken, is entitled to judgment thereon against this defendant.

COOK et al. v. KLONOS et al.

(Circuit Court of Appeals, Ninth Circuit. October 5, 1908.)

No. 1,510.

1. EXCEPTIONS, BILL OF (§ 36*)—SETTLEMENT—POWER OF COURT.

The fact that an appeal has been allowed, a supersedeas bond approved and filed, and a citation issued does not deprive the trial judge of power to thereafter settle and sign a bill of exceptions during the same term at which the decree appealed from was entered, where it was duly presented to him for settlement before the appeal was allowed.

[Ed. Note.—For other cases, see Exceptions, Bill of, Cent. Dig. § 45, Dec. Dig. § 36.*]

2. EQUITY (§ 363*)—ALASKA CODE—DISMISSAL FOR LACK OF PROOF.

A motion by the defendant at the close of plaintiff's case to dismiss a suit of an equitable nature on the ground that plaintiff has failed to make a prima facie case, under Code Civ. Proc. Alaska, § 378 (Act June 5, 1900, c. 786, 31 Stat. 395), which authorizes the dismissal of such a suit whenever upon the trial it is determined that the plaintiff is not entitled to the relief claimed, or any part thereof, like a motion in an action at law for a nonsuit or direction of a verdict on the same ground, admits every fact which the evidence proves, or tends to prove, as well as the facts which may naturally and rationally be inferred from the facts proved.

[Ed. Note.—For other cases, see Equity, Cent. Dig. § 766; Dec. Dig. § 363.*]

3. MINES AND MINERALS (§ 38*)—SUIT TO QUIET TITLE TO MINING CLAIM—EVIDENCE.

In a suit to quiet title to an association placer mining claim, evidence that plaintiffs located the claim, marked its boundaries by stakes and monuments, put up and recorded a proper location notice, and went into peaceable possession, following it by sinking two shafts to bed rock, in which they first discovered gold at a depth of 72 feet, and that there were no other excavations on the claim, except a hole a foot or so in depth, is sufficient prima facie to show that at the time of the location the ground was unappropriated public land of the United States, its mineral character being admitted, although it further appeared that there were other stakes and location notices within the limits of the claim, not shown, however, to belong to defendants; a discovery being essential to any valid prior location.

[Ed. Note.—For other cases, see Mines and Minerals, Cent. Dig. § 102½; Dec. Dig. § 38.*]

4. MINES AND MINERALS (§ 14*)—FRAUDULENT ENTRY—ASSOCIATION CLAIM.

Under Rev. St. §§ 2330, 2331 (U. S. Comp. St. 1901, p. 1432), which authorize two or more persons to make a joint entry of placer claims not exceeding 160 acres for any one association, provided that no such location shall include more than 20 acres for each individual claimant, the location of a claim of 160 acres in the name of eight persons is fraudulent and void as against the United States, where it was made pursuant to a previous agreement by which another person, not even one of the locators, was to receive an interest exceeding one-third of the entire claim, and will not be protected by a court of equity.

[Ed. Note.—For other cases, see Mines and Minerals, Dec. Dig. § 14.*]

Appeal from the District Court of the United States for the Third Division of the Territory of Alaska.

*For other cases see same topic & § NUMBER in Dec. & Am. Digs. 1907 to date, & Rep'r Indexes
164 F.—34

John L. McGinn, Martin L. Sullivan, and Heilig & Tozier (Campbell, Metson, Drew, Oatman & Mackenzie and E. H. Ryan, of counsel), for appellants.

Fernand De Journal and H. J. Miller (T. C. West, of counsel), for appellees.

Before GILBERT, ROSS, and MORROW, Circuit Judges.

MORROW, Circuit Judge. This action was commenced by appellants against the appellees in the District Court for the Territory of Alaska, Third Division, April 20, 1905. A second amended and supplemental complaint was filed April 28, 1905, setting up three causes of action: (1) An action on the part of plaintiffs (appellants) against defendants (appellees), alleging that since the 24th day of March, 1905, the plaintiffs have been the owners in fee, as to all persons save the United States, of a certain placer mining claim in the Fairbanks recording district, situated on the right limit of Dome creek, and known as the "Dome Group," more particularly marked upon the ground and described by courses, distances, and stakes. It is alleged that the defendants claim an estate or interest in said property adverse to the plaintiffs, but that said claim is without any right whatever. (2) It is alleged in the second cause of action that prior to the 24th day of March, 1905, the property described was a part of the vacant and unappropriated public domain of the United States, and was free and open to exploration and purchase by the citizens thereof for the valuable mineral deposits therein contained; that on the 24th day of March, 1905, the plaintiffs, being citizens of the United States, entered upon said ground and segregated the same from the public domain by distinctly marking the boundaries thereof upon the ground, so that the same could be readily traced; that on the 16th day of April, 1905, plaintiffs made a discovery of gold within the exterior boundaries of said property, and thereafter, on the 17th day of April, 1905, they caused to be recorded in the records of the Fairbanks recording district of Alaska a notice of location of said claim, giving the names of the plaintiffs as locators, the date of said location, and such a description of said claim with reference to natural objects and permanent monuments that the same could be readily identified; that the defendants assert that they are, and they pretend to be, the owners of certain parts, portions, and parcels of the ground described, under and by virtue of pretended placer mining locations made by them or those under whom they claim prior to the title of plaintiffs; that said assertions of title and pretensions of ownership on the part of defendants and each of them are wrongful and without right; that neither the defendants nor those under whom they claim ever at any time have made a discovery of gold within the boundaries of any portion or parcel of ground claimed by them or either of them; that neither the defendants nor those under whom they claim ever, prior to the location of the plaintiffs or at any time, marked the location of their boundaries upon the ground, so that the same could be readily traced; that the claims of defendants cause a cloud upon the possession and title of plaintiffs, and prevent them from enjoying fully and peacefully the fruits of

their ownership of the property. (3) In the third cause of action plaintiffs' ownership of the placer mining claim described in the first and second causes of action is alleged, and it is charged that defendants have entered upon and trespassed upon certain portions of the property, and have proceeded to mine and remove and appropriate, and convert to their own use, the gold and mineral contained in the land, and to cut and remove and use the trees and timber growing thereon; that the defendants and each and all of them are insolvent, and not able to respond in damages to the plaintiffs. The prayer of the complaint is that the defendants be required to set forth the nature of their claims in and to the property described, and that all adverse claims of the defendants be determined by a decree of the court, and that by such decree it should be ordered and adjudged that the defendants have no estate or interest whatsoever in and to said land and premises; that the cloud cast upon plaintiffs' title be removed; that an account be taken of all gold extracted by the defendants, and that a judgment be entered against the defendants for the amount so extracted; that pending the action a temporary injunction issue against the defendants, restraining them from extracting gold from the premises, and upon a final hearing that the injunction be made perpetual; that it be adjudged that the plaintiffs are the owners in fee of said premises as to all persons save and except the United States, and are entitled to the sole and exclusive possession thereof; that defendants be enjoined from making any claim thereto; for plaintiffs' costs, and for general relief. The defendants answered the complaint, denying the allegations thereof, except that they all admitted that they asserted ownership of certain portions and parcels of the ground in controversy, and, alleging title and possession in themselves, set forth certain facts connected with such claims of ownership. The plaintiffs replied, denying all the allegations of the several answers, and upon the issues thus presented the case was tried in April, 1907.

Three witnesses were introduced on behalf of plaintiffs—R. A. Jackson, a civil engineer; J. C. Ridenour, one of the plaintiffs; and E. T. Barnette, who claimed to represent six absent locators as attorney in fact. The testimony of R. A. Jackson was to the effect that he had visited the upper end of the claim in June, 1905, saw a number of stakes of the Dome Group at that time, and all the stakes but one on November 5, 6, 7, and 8, 1906, when in company with Cook, one of the plaintiffs, he spent four days making a survey of the group, and from data obtained at that time and previously, compiled a map of the Dome Association Group, showing all conflicting claims of which he had knowledge, which plat was introduced in evidence by plaintiffs. He testified that he found all but one of the stakes in place, and a cut-out line in the underbrush definite enough to indicate the course from each stake to the next succeeding one.

J. C. Ridenour testified that he and his coplaintiff, Henry Cook, entered upon the property in question on March 22, 1905, and took possession of a cabin which they found there; that this cabin was occupied by witness from March 22, 1905, to June 10, 1905; that Henry Cook and Peter Morrison also lived with witness in the cabin; that on the

23d of March Cook left, and the witness proceeded to stake out the claim, placing the initial stake near the cabin, and establishing 25 other boundary stakes of suitable size; that these stakes were established at intervals of about 600 feet, so as to include within the boundaries of the claim about 160 acres. On the initial stake the witness posted a notice of location, a copy of which was afterward, on April 17, 1905, recorded with the commissioner and ex officio recorder of the Fairbanks recording district. A certified copy of this recorded notice was introduced in evidence. The location notice included the signatures of himself and Cook and six others, whom he did not know; but he put the notice up under the order of Cook, after filling in the directions from stake to stake in blanks left for that purpose; that the list of names came out to him with some supplies sent out to him by Capt. Barnette; that he had no authority to locate a placer mining claim for A. D. Armstrong, only that Henry Cook told him to locate it, and the same as to the other six locators who were absent; that the staking was finished on the afternoon of March 24th by placing the completed notice of location in a candle box fastened to the initial stake, claiming the property in the name of himself and Cook and the six other parties; that he had never seen anything upon the property that indicated in any way that there ever had been a shaft sunk on the property; that he had seen some stakes of other mining claims, also notices posted at various places within the limits of the ground located as the Dome Association Group at the time he located it; that later he had found a hole where some one had started prospecting. This was a little place about a foot deep and about 3 feet by 6 feet. After staking out the claim Ridenour testified that he immediately began on March 24, 1905, to sink a shaft at a distance of about 150 feet from the initial stake, he and a man named Morrison working six or seven days, when Cook arrived and took Morrison's place, and the two worked until about the 18th or 20th of May, when they reached bed rock, after going through 62 feet of muck and 65 feet of gravel, finding four or five colors of gold at a depth of about 10 or 15 feet of gravel on the 15th of April, 1905, and later found as high as 25 colors about the 1st of May; that they found the bed rock dipping toward the hill and about the 7th or 8th of June left that shaft and moved 2,700 feet away, further down stream and further away from the creek; commenced to dig about the 10th of June, and first found gold the latter part of July—something like about 4 feet of dirt that would go from 2 to 20 cents per pan. They went through 50 feet of muck and 78 feet of gravel. The two worked practically continuously on the property from March, 1905, until April, 1906, excepting for a week or two in town to get supplies, and laying off during the month of January owing to the extreme cold. With respect to the colors of gold found in shaft No. 1 on April 15, 1905, the witness testified that from the character of the material in which the gold was found, and the gold found, he believed that an ordinarily prudent man was justified in going ahead in spending further money and labor on the property with reasonable chances of developing a paying mine, and upon the strength of what he found in that shaft he did do other work upon the property.

The testimony of E. T. Barnette was offered to establish the bona fide character of the absent locators. On direct examination he identified various documents which had previously been introduced for identification, including several powers of attorney giving him full authority to locate claims in the names of the absent locators and full control over such claims when located, and a deed which he had signed on behalf of these six locators conveying to Cook and Ridenour a one-twelfth interest in the claim. On cross-examination the witness testified that each of these six absent locators, with one exception, was related to witness, either directly or indirectly; that there had been an understanding between himself and Cook and Ridenour in March, before the location was made, that Cook and Ridenour were to stake the claim, put a hole to bed rock, and witness was to furnish the tools and boiler; that Cook and Ridenour were each to have a one-eighth interest in the group claim; that there was no understanding that witness was to have any interest in the group by them nor by anybody; that McGinn and Sullivan were to get one-third interest in the group for looking after the litigation and protecting the property; that the witness was figuring on a half interest from the people he represented (the absent locators), and later said that when he sent for the power of attorney he stated in his letter to his brother-in-law that he would stake for them and would expect a half interest, but had never had any agreement with them; that in response to that letter he received the power of attorney. He took it for granted, according to the letter he wrote his brother-in-law, that he would have a half interest from them.

At the close of plaintiffs' testimony a motion was made to strike from the records all the testimony and evidence in the case relating to the performance of any acts of location of the claim of plaintiffs subsequent to the 20th day of April, the date of the commencement of the suit. This motion was granted as to defendant Klonos, and denied as to the other defendants. Motions were also made for a nonsuit and for a judgment dismissing the plaintiffs' bill, substantially on the grounds: (1) That the plaintiffs' location of eight claims, of 20 acres each, constituting the alleged Dome Group of claims, of the aggregate area of 160 acres, was not made by bona fide locators, but in the name of dummy locators, in fraud of the United States, in violation of the public land laws; (2) that the plaintiffs had not shown that prior to and at the time of the location of these eight claims the ground the possession of which is the subject of controversy was vacant and unappropriated public lands of the United States; (3) that the plaintiffs had not shown a valid possession or location of the claims, or that the boundary of the same had been marked or a discovery made thereon as required by law.

The motions were granted, on the ground that plaintiffs had not proved a prima facie case; the court stating that it was on the ground that the evidence showed that there was former occupation of the premises, and plaintiffs had not shown that the ground was unappropriated. The court, in granting the motion, said:

"Had there been no evidence of staking or location notices and other acts of appropriation upon the ground, it might have been possible that you had gone as far as you need, by proving your staking, discovery, and filing of notice;

but I think there is so much evidence of former appropriation in—and your pleadings admit it—that you now must show, not under your second cause of action, but under your first, if you rely upon that, that it was unappropriated public domain at the time you went upon it.

“Mr. McGinn: Your honor means the whole of the property, each and every part of it?”

“The Court: Yes.

“Mr. McGinn: And your honor also means, by that, that we would have to go to the extent, even if there was a staking of the property and notices, of showing as a negative proposition that there never was a discovery of gold upon the property.

“The Court: I think so.

“Mr. McGinn (continuing): Upon any location claimed by them. I mean, a discovery of gold upon each location made by them.

“The Court: What was that last?”

“Mr. McGinn: I want to know whether it will be incumbent upon us to prove affirmatively the negative proposition that there was never a discovery of gold made by any of the defendants in this action upon any of the property claimed by them.

“The Court: If you show failure in any one of the essentials of a valid location, that is sufficient.”

Before proceeding to examine the questions involved in the appeal, it is necessary to consider the questions involved in the motion made by the appellees to strike out the bill of exceptions and to dismiss the appeal, on the ground that the order made by the judge, dated July 12, 1907, settling and allowing the bill of exceptions, was made at a date subsequent to the order allowing the appeal, and the taking of the appeal. The record shows that the judgment in the court below dismissing the bill was entered June 3, 1907, and the bill of exceptions was presented to the judge June 28, 1907, but was not signed by the judge until July 12, 1907. The assignment of errors was served June 26, 1907, and filed June 29, 1907. The petition for appeal was presented to the judge June 26, 1907, and filed June 29, 1907. The bond on appeal (supersedeas) was approved June 29, 1907. Citation on appeal was dated June 29, 1907. It is contended on behalf of the appellees that on July 12, 1907, when the judge signed the bill of exceptions, he had no jurisdiction to make the order settling the same, on the ground that the cause had at that time been removed to this court by the allowance of the appeal, and the filing of the supersedeas bond on appeal, and the issuance of the citation thereon.

The motion to strike out the bill of exceptions and dismiss the appeal must be denied. The bill of exceptions was drawn up and presented to the judge for settlement prior to the allowance of the appeal, and was settled and signed by him during the term in which the judgment was rendered. In *Shreve v. Cheesman*, 69 Fed. 785, 16 C. C. A. 413, the Circuit Court of Appeals for the Eighth Circuit held that the fact that a bill of exceptions showing the proceedings on a motion for a new trial after judgment was certified after the issuance of a writ of error from the Supreme Court to review the judgment did not deprive the court below of its jurisdiction or relieve it of the duty to make a true record of the proceedings in that court after the judgment. In *Hunicutt v. Peyton*, 102 U. S. 354, 26 L. Ed. 113, it was held that exceptions reserved at the trial of the case may be reduced to form and presented to the judge for his signature, notwithstanding that a writ

of error is sued out before his signature is obtained. In *Davis v. Patrick*, 122 U. S. 138, 7 Sup. Ct. 1102, 30 L. Ed. 1090, the Supreme Court refused to strike out a bill of exceptions signed after the beginning of the term of the Supreme Court at which the writ of error was returnable and during the term of the Circuit Court succeeding that in which the case was tried; the bill having been seasonably submitted to the judge for signature and the delay having been caused by him.

We now come to the consideration of the questions involved in the appeal. We are of the opinion that the court was in error in dismissing the complaint on the ground that the evidence of former occupation and appropriation of the premises was of such a character that plaintiffs were required to show affirmatively that at the time of their location of the claim the land was vacant and unappropriated public land of the United States. The motion of the defendant in the court below to dismiss the action is made under section 378 of chapter 39 of the Code of Civil Procedure of Alaska (*Carter's Ann. Code Alaska*, p. 227; Act June 5, 1900, c. 786, 31 Stat. 395). The chapter is entitled "Of the Trial of Issues in Actions of an Equitable Nature," and section 378 provides as follows:

"Whenever upon the trial it is determined that the plaintiff is not entitled to the relief claimed, or any part thereof, a judgment shall be given dismissing the action, and such judgment shall have the effect to bar another action for the same cause or any part thereof, unless such determination be on account of a failure of proof on the part of the plaintiff, in which case the court may, on motion of such plaintiff, give such judgment without prejudice to another action by the plaintiff for the same cause or any part thereof."

In an action at law, if the plaintiff at the conclusion of his testimony has failed to make out a prima facie case, the defendant may move the court for a nonsuit or for an instruction to the jury to find a verdict for the defendant. In such case the defendant, for the purpose of the motion, admits every fact which the evidence proves or tends to prove, as well as the acts which may naturally and rationally be inferred from the facts proven. *Dodge v. State Bank*, 2 A. K. Marsh. (Ky.) 612; *Pleasants v. Fant*, 22 Wall. 116, 122, 22 L. Ed. 780; *Dow v. Gould & Curry S. M. Co.*, 31 Cal. 629, 650. There is no reason why this rule should not be applicable to a like motion to dismiss in an action of an equitable nature. *Heidenrich v. Heidenrich*, 18 Ill. App. 142.

The evidence shows that on March 22, 1905, Cook and Ridenour, for themselves and representing six absent locators, entered upon the premises peaceably and without force or fraud, or in any surreptitious or clandestine manner, and that they have since remained in peaceable possession of the ground; that on March 23 and 24, 1905, they located the ground as an association placer claim in accordance with the provisions contained in section 2330 of the Revised Statutes (U. S. Comp. St. 1901, p. 1432); that this location was recorded April 17, 1905, with the recorder of the district in which the claim was located, as required by section 15 of the act of June 5, 1900 (31 Stat. 321, 327, c. 786); that the claim as recorded contained the names of the locators, the date of the location, and such a description of the claim located by

reference to natural objects and permanent monuments as would identify the claim as required by section 2324 of the Revised Statutes (U. S. Comp. St. 1901, p. 1426); that the plaintiff Ridenour and an employé sunk a shaft on the claim to bed rock, a distance of 127 feet; that on April 15, 1907, at a depth of about 72 feet in the shaft, they discovered gold in the gravel. There is no evidence that the defendants had made any discovery upon the premises prior to that time. There was evidence that there was a cabin on the claim, of which Cook and Ridenour took possession; but there is no evidence that the cabin belonged to the defendants, or that it was a cabin that had been occupied by miners. Ridenour testified that he had seen some stakes of other mining claims, also notices posted at various places within the limits of the ground located by plaintiffs; but there is no evidence that these stakes were placed upon the ground by the defendants or that the notices were posted by them. Ridenour also testified that he had never seen anything upon the property that indicated in any way that there ever had been a shaft sunk on the property; that he had found a hole where some one had started prospecting, a little place about a foot deep and about 3x6 feet, but there was no evidence that this hole had been sunk by the defendants or that any discovery of gold had been made therein. No one appears to have been in possession of the ground when plaintiffs entered upon it, and the inference is that the prospect hole had been abandoned. Moreover, the plaintiffs did not make a discovery of gold in this ground until they had sunk a shaft to the depth of about 72 feet—62 feet through muck, and 10 to 15 feet through gravel; and the natural inference to be drawn from this fact is that no discovery had been made in the shallow prospect hole which Ridenour saw on the claim, and there was no evidence that there was any other place where prospecting had been done.

The evidence is, therefore, to the effect that plaintiffs made the first discovery of gold upon the ground in controversy; and this is the essential fact in determining the right of possession to mining ground. Priority of discovery gives priority of right against naked location and possession. Section 2320, Rev. St. (U. S. Comp. St. 1901, p. 1424); Lindley on Mines (2d Ed.) § 216; Crossman v. Pendery (C. C.) 8 Fed. 693; Horswell v. Ruiz, 67 Cal. 111, 7 Pac. 197; Garthe v. Hart, 73 Cal. 541, 15 Pac. 93; Gemmell v. Swain, 28 Mont. 331, 72 Pac. 662, 98 Am. St. Rep. 570; Belk v. Meagher, 104 U. S. 279, 26 L. Ed. 735; Johanson v. White (C. C. A.) 160 Fed. 901. "Discovery of mineral is the initial fact. * * * Without that no rights can be acquired. * * * It is undoubtedly true that discovery is the initial fact. The language of the statute makes that plain, and parties may not go on the public domain and acquire the right of possession by the mere performance of the acts prescribed for a location." Creede & Cripple Creek Mining & Milling Company v. Uinta Tunnel Mining & Transportation Company, 196 U. S. 337, 345, 353, 25 Sup. Ct. 266, 49 L. Ed. 501. The evidence relating to these proceedings shows that the statute relating to the location of the claim had been followed very closely by the plaintiffs, and the inference to be drawn from the evidence relating to possession and discovery is that the ground located

by them was at the time of the location vacant and unappropriated public land of the United States.

But, in our opinion, there was evidence to support the motion to dismiss the complaint on the ground that plaintiffs' location was not made in the names of bona fide locators, but that the notice contained the names of six dummy locators, in fraud of the United States and in violation of public land laws. E. T. Barnette testified that in March, 1905, before the location was made, he had an understanding with Cook and Ridenour as to the ownership of the claim. They were to stake the claim, make a discovery, and put a hole to bed rock. The witness was to furnish the supplies, tools, and boiler. They were to have each one-eighth interest in the group claim. In April, 1906, this interest was increased to a one-sixth each by a deed from Barnette as attorney in fact for six absent locators. Barnette gave Cook and Ridenour the names of these six absent persons, who it appears were not residents of Alaska, but of the state of Ohio. Four of these were relatives of Barnette—two of them brothers-in-law, one a sister, and one a niece. Barnette wrote to one of these brothers-in-law and obtained powers of attorney from these six persons. The powers of attorney were all dated July 7, 1900, and they all empower Barnette to locate, enter, and take up mining claims in Alaska. He wrote to his brother-in-law that he expected a half interest in the claims located for these absent locators, and when he received the powers of attorney he took it for granted that he was to have a half interest from them. Here were six absent locators, who were to secure the right of possession to 120 acres in the associated claim of 160 acres, and it was understood that a half interest or the equivalent of 60 acres, was to go to Barnette, who was not himself a locator, but was to secure the equivalent of three single locations by this method of securing interests. Barnette also entered into an agreement with McGinn and Sullivan that they should have a one-third interest in the property for looking after the litigation. This one-third interest was the equivalent of 53½ acres of the location. This distribution of interests by Barnette, who appears to have been the moving spirit in securing possession of the ground, was made before the entry and location of the claim, and when, as Barnette testifies, there was an understanding between him and Cook and Ridenour as to the ownership of the claim, and this understanding entered into the act of entry and location, rendering it fraudulent and void as against the United States.

It is true that section 2330 of the Revised Statutes provides that two or more persons or associations of persons having contiguous claims of any size, although such claims may be less than 10 acres each, may make joint entry thereof. This provision is subject to the limitation that no location of a placer claim made after the 9th day of July, 1870, should exceed 160 acres for any one person or association of persons; but the prohibition contained in section 2331 against the location of "more than twenty acres for each individual claimant" is direct and positive, and limits the amount of ground that any one claimant may appropriate, either individually or in association claim, at the time of the location. There is nothing in Smelting Company v.

Kemp, 104 U. S. 636, 651, 26 L. Ed. 875, contrary to this doctrine. What the court there held was that the locator's interest in a mining grant is salable and transferable, and that it was—

"difficult to perceive what object would be gained, what policy subserved, by a prohibition to embrace in one patent contiguous mining ground taken up by different locations and subsequently purchased and held by one individual. He can hold as many locations as he can purchase, and rely upon his possessory title."

The question here is, not whether an individual can purchase mining claims after they have been located and hold them in his own name, but whether an individual can, by the use of the names of his friends, relatives, or employes as dummies, locate for his own benefit a greater area of mining ground than that allowed by law. If such proceedings were to be recognized as legal, then in this case Barnette was at the time of the location of the claim, and ever since has been, the principal locator of 160 acres, and yet he was not himself a locator by notice on the ground or of record, and he is not a party to this action. How can such proceedings receive judicial sanction? This controversy is in a court of equity, where the maxim prevails that "he who comes into equity must come with clean hands."

In *Mitchell v. Cline*, 84 Cal. 410, 415, 24 Pac. 164, the Supreme Court of California refused to investigate and enforce certain agreements with respect to titles to mining claims acquired from the government by patent based upon locations made in the names of dummy locators. The refusal of the court was based upon the fact that the title had been obtained by false and fraudulent representations and in violation of the express provisions of law. The court, referring to section 2331, Revised Statutes of the United States, providing that "no such locations [of placer claims] shall include more than twenty acres to each individual claimant," said:

"The policy and object of this law are to limit the quantity of placer mineral land which may be located by one person to 20 acres, and, although one person may obtain a patent for more than 20 acres, he can do so only by representing to the government that he is a purchaser of the excess from one or more bona fide locators, whose locations were made in conformity with the above statutory limitation as to quantity. For this purpose he is required to present with his application for patent an authenticated abstract of his title, showing its derivation from lawful locations."

In *Gird v. California Oil Co.* (C. C.) 60 Fed. 531, 545, Judge Ross held that under section 2331, Rev. St., a claim located by three persons must be limited to 20 acres, when it appears that they are in the employ and acting in the interest of a single company.

The mineral land laws of the United States are extremely liberal in the requirements under which possessory rights may be acquired. The few restrictions imposed are only intended to prevent the primary location and accumulation of large tracts of land by a few persons, and to encourage the exploration of the mineral resources of the public land by actual bona fide locators. The scheme of using the names of dummy locators in making the location of a mining claim for the purpose of securing a concealed interest in such claim appears to be contrary to the purpose of the statute; but when this scheme is used

to secure an interest in a claim for a single individual, not only concealed but in excess of the limit of 20 acres, it is plainly in violation of the letter of the law, and when, as in this case, all the locators had knowledge of the concealed interest and were parties to the transaction, it renders the location void.

It follows that the court below was right in dismissing the complaint, and for the reasons here stated the judgment of dismissal is affirmed.

HARRISON v. CLARKE et ux.

(Circuit Court of Appeals, Eighth Circuit. September 21, 1908.)

No. 2,667.

1. APPEAL AND ERROR (§ 80*)—APPEALABLE DECREE—FINAL DECREE.

A decree in equity which purports to settle finally and definitely the merits of the entire controversy between the parties is a final decree, from which an appeal lies, although the court retains jurisdiction in aid of its execution in accordance with the adjudicated rights of the parties.

[Ed. Note.—For other cases, see Appeal and Error, Cent. Dig. §§ 494-509; Dec. Dig. § 80.*]

2. PARTNERSHIP (§ 333*)—SUIT FOR SETTLEMENT—BREACH OF CONTRACT.

Complainant and defendant entered into a contract of partnership for the purchase of lands along a lake shore as a site for a summer resort and to develop and sell the same. By the terms of the agreement complainant was to attend to the business of the partnership and defendant was to furnish the money required to pay for the lands and for the payment of taxes and necessary expenses, and from the proceeds of the land when sold he was to be repaid his advances, with interest, and complainant was to receive a sum equal to such interest for his services; the remainder to be equally divided. After complainant had purchased and paid for a portion of the lands, and expended other sums for expenses, taxes, and securing options on other lands, defendant without justification repudiated the contract and refused to make the advances required thereby, in consequence of which the enterprise came to an end. *Held*, in a suit to wind up the partnership and recover damages for breach of the contract, that complainant was not entitled to damages for loss of profits, which were too uncertain and speculative, nor beyond legal interest on the sums advanced by him; but, the contract having been broken by defendant, so that payment for his services could not be measured thereby, he was entitled to recover their reasonable value and to a personal judgment against defendant for so much thereof as was not realized from the proceeds of the property purchased, when sold, after paying the other demands chargeable thereon.

[Ed. Note.—For other cases, see Partnership, Dec. Dig. § 333.*]

Appeal from the Circuit Court of the United States for the Northern District of Iowa.

T. W. Harrison (Frank Farrell, on the brief), for appellant.

William G. Clark, for appellees.

Before HOOK and ADAMS, Circuit Judges, and PHILIPS, District Judge.

HOOK, Circuit Judge. This is an appeal by Harrison from a decree in a suit brought by him against Clarke to wind up the affairs of

*For other cases see same topic & § NUMBER in Dec. & Am. Digs. 1907 to date, & Rep'r Indexes

a partnership between them and for damages for a breach by the latter of the partnership contract. Clarke, the defendant, moves to dismiss the appeal because, as he says, the decree is interlocutory, not final. But the decree purports to settle finally and definitely the merits of the entire controversy and to leave nothing undone but to execute it. The retention of jurisdiction by the trial court was simply in aid of the details of execution according to the adjudicated rights of the parties. The motion must therefore be denied.

The partnership was first formed orally, and after the parties operated thereunder for several months the terms of the contract were reduced to writing. The purpose was to engage in the purchase, development, and sale of lands along and within two miles of the west shore of the lake known as "Mille Lacs," in Minnesota. Harrison, the complainant, was to contract for and purchase the lands, both parties were to "use their best influences and endeavors to develop" them and "realize therefrom the most possible," and the complainant was to sell them. The defendant was to furnish the money for the purchase price, taxes, and all necessary actual expenses in making purchases and sales. He was to repay complainant, upon request and the production of vouchers, the moneys expended by him for such purposes prior to the date their contract was reduced to writing, with interest at 6 per cent. Complainant's time in buying, selling, and handling the lands and the securities arising from the disposition of them was placed against the use of defendant's money. The partnership was to endure until all the lands were sold and the proceeds collected and distributed, unless sooner dissolved by mutual consent. The proceeds were to be divided and paid as follows: (1) To defendant, the amount advanced by him for the purchase of the lands, and for taxes and expenses; (2) to defendant, interest on his advancements at 6 per cent.; (3) to complainant, for his services, a sum equal to the interest paid defendant; (4) the balance equally between them. Probably because of confidence in the success of the enterprise no express provision was made regarding losses. The law would supply it. The lands within the scope of the contract comprised between 2,000 and 3,000 acres, with about five miles of continuous shore line. When the lands were acquired they were to be put upon the market as an attractive site for a summer resort. The evidence gives that meaning to the clause of the contract requiring both parties to "use their best influences and endeavors to develop said lands," etc. After complainant had expended over \$5,000 in the purchase of part of the lands, the payment of taxes, and for expenses connected with such purchases and the securing of options and opportunities to purchase other lands, and had also personally obligated himself for several thousand dollars more, he asked defendant to repay the advancements according to the terms of their contract, and persisted in his requests without result for more than a year. The defendant, after repeated promises to pay, finally repudiated his obligation. He demanded that the partnership relation be converted into the ordinary one of debtor and creditor, and that the money he would pay be considered as a loan and secured by the lands purchased, the title to be placed in his name for that purpose. This

position was taken without justification in the terms of their contract or in the conduct of complainant. The enterprise came to an end when less than half the lands and but a small part of the shore line had been acquired.

The trial court found to be due complainant, including interest to a date near that of the decree, for taxes paid \$657.20, for expenses in connection with lands actually purchased \$1,819.48, and for purchase money paid \$11,654.18, and to defendant \$3,040.83. The last-mentioned sum was on account of a note for \$2,500 discounted by complainant at a bank designated by defendant to raise funds for their venture, and finally taken up by the latter; the interest to the date above referred to being \$540.83. Complainant's principal assignments of error are that the trial court denied him recovery for (1) damages to his financial credit by defendant's failure to repay his advancements; (2) profits that might have been made had the contract been fully carried out; and (3) the value of his services. No error was committed in respect of the first two of these. There is nothing in the case taking it out of the general rule that principal and interest thereon is the legal measure of damage for failure to pay money when due (*Loudon v. Taxing District*, 104 U. S. 771, 774, 26 L. Ed. 923); and the proof of anticipated profits was insufficient for their ascertainment with that reasonable certainty which the law requires—they were too remote and speculative. But we think the court erred in its treatment of complainant's claim for services.

By the letter of the contract the value of his services was fixed at a sum equal to the amount of interest at 6 per cent. per annum upon all sums advanced by defendant for the purchase of lands, and taxes and expenses in making purchases and sales; that is to say, complainant's services were placed against the use of defendant's money, but this was upon the assumption that defendant would remain faithful to the enterprise to the conclusion contemplated and perform his obligation to furnish all funds needed, including the prompt repayment of complainant's preliminary advancements. By the decree the complainant was awarded for his services a sum equal to the interest on the \$2,500 paid by defendant and on the amount complainant himself paid for purchase money, excluding his payments for taxes and expenses. The sum so awarded him was placed at the foot of the items entitled to participation in the proceeds of the lands decreed to be sold, and therefore left to take the chance of their sufficiency. In other words, though defendant wrongfully put an end to the enterprise, his investment and interest thereon were given precedence over the services of complainant, who observed the contract; and defendant was allowed to profit by his default, which made it impossible justly to apply the stipulated measure of compensation to complainant for his services. This was upon the theory that there was no competent proof of the value of the services save that furnished by the contract itself. We think there was such proof. The complainant testified in considerable detail as to what he did under the contract, the trips he made, the lands he purchased, secured options upon, and opportunities to purchase, and the skill required and exercised in doing

so to advantage. This, with his previous experience in that business, and his testimony that he knew the value of his services, qualified him to speak. He said his services were reasonably worth \$12,000, and there was no testimony to the contrary. Though the estimate of value is not conclusive (*Head v. Hargrave*, 105 U. S. 45, 26 L. Ed. 1028) it is not obviously excessive, and, having the basis we find in the record, it should be accepted, especially since defendant did not see fit to dispute it. Complainant should be awarded the sum mentioned, and it should displace the award made him on the basis of interest on money expended.

Again, the services rendered by complainant to carry out the contract were not confined to the lands actually purchased. Therefore to restrict his recovery, as was done, to the proceeds of lands actually purchased, would be to charge them with an expense not incurred on their account, but which became fruitless of value to the firm because of defendant's default. If the services had been performed, and the contract had been repudiated before any lands whatever were bought, it would seem clear the complainant would have been entitled to a personal judgment at law for his damages, an element of which might very properly have been the reasonable value of the services, and we perceive no reason for applying a different rule in equity in a case like this, where to a substantial degree the purpose of the contract was defeated and by the breach of defendant the measure of compensation contracted for is not justly applicable. The defendant, being in the wrong and wholly responsible for the necessity of resort to litigation, should pay the costs of the suit. If the proceeds of the lands decreed to be sold are insufficient to pay all of the demands upon them, the defendant should be held personally liable for such part of the deficit as is attributable to the costs and the award to complainant for his services. We think that in other respects the decree as entered by the trial court is right, and not subject to the criticisms made in the assignments of error.

The decree is reversed, and the cause is remanded, with direction to enter one as indicated in the foregoing opinion.

NOTE.—The following is the opinion of Reed, District Judge in the court below:

REED, District Judge. This suit is for an accounting and recovery of damages from defendant for his failure to perform an agreement in writing, dated April 14, 1903, to advance money to pay for certain lands alleged to have been purchased by complainant for himself and defendant pursuant to such agreement. The contract is as follows:

"This agreement, made and entered into this 14th day of April, 1903, by and between A. D. Clarke, of Algona, Iowa, party of the first part, and T. W. Harrison, of Topeka, Kansas, party of the second part, witnesseth: That all tracts, lots, and parcels of land along the west shore or within two miles of the west shore of the lake known as Mille Lacs, in the state of Minnesota, which said second party has already purchased, bought, and contracted for, and for all tracts, lots, and parcels of land along the west shore or within two miles of the west shore of said lake known as Mille Lacs, in the state of Minnesota, which said second party may hereafter purchase, buy, or contract for, the said first party shall furnish the money to pay the purchase price for all of said lands, and to pay all taxes and necessary actual expenses in making the purchase and sale of said lands, and interest at the rate of 6 per

cent. per annum on such sums as said second party has advanced or shall advance to make payments thereon from the time paid by said second party until the same is repaid to him by said first party, the same to be paid to said second party on request therefor, and the production of vouchers, contracts, or deeds showing such payment; and said second party shall do the buying and selling of said lands, and the contracts, deeds, titles, and securities for said land shall be held in the name of said second party, and both said first party and said second party shall use their best influence and endeavors to develop said lands and realize therefrom the most possible, and the time of said second party in buying, selling, and handling said land and the securities thereon shall be placed against the use of the money so furnished by said first party, and, when said lands are sold, from the money received and collected therefrom there shall be paid: First, to said first party the money so advanced by him for the purchase of said land and for all taxes paid thereon and for all necessary actual expenses paid in making the purchase and sale of said land; second, to said first party interest at the rate of 6 per cent. per annum on all money so advanced by him from the time it was so advanced until it is repaid to him; third, to said second party a sum equal in amount to that which shall be paid to said first party for and on account of interest aforesaid; fourth, the balance of the proceeds arising from the sale of said lands shall be divided equally between said first party and said second party, share and share alike. This contract shall remain in force until all the lands so purchased and held in pursuance thereof shall have been sold, and the proceeds therefrom collected and distributed as herein provided, unless the same is sooner dissolved by mutual consent of the parties hereto, and a mutual division of the land, proceeds, and securities held thereunder.

"In witness whereof, the said parties have hereunto set their hands and affixed their seals the day and date first above written herein."

The defendant A. D. Clarke admits in his answer that he signed the contract, but alleges that, through the fraud of complainant in drawing the same, it does not correctly express the actual agreement between him and the complainant, which was that defendant would loan complainant the money necessary to purchase said lands, the titles to the lands to be taken in the name of the defendant as security for said loan; that the lands described in the bill of complaint, except one tract, were contracted for by complainant prior to the date of the contract, and that defendant paid \$2,500 thereon before he discovered such fraud, and refused to pay any further sum, unless the contract was corrected to conform to the actual agreement; and by a cross-bill prays that the writing be reformed so as to correctly express such agreement. The validity of the contract is not otherwise challenged by the pleadings and other issues need not be stated. The pleadings are voluminous, and a large amount of testimony has been taken. It would serve no useful purpose to review the testimony at length, and it must suffice to state the conclusions which have been reached from a careful consideration of the whole thereof. Such conclusions are:

(1) That the evidence is not sufficient to warrant a reformation of the contract as prayed by the defendant.

(2) That the complainant is not entitled to recover for his time and services in making the purchase of the lands actually bought or contracted for by him, other than as provided in said contract.

(3) That complainant is entitled to recover the actual and necessary expenses incurred by him in purchasing said lands, and the amounts advanced to pay taxes upon, and the purchase price of the lands, with 6 per cent. interest upon said sums from the date of their payment by him. Said amounts to be repaid to or recovered by him as hereinafter ordered.

(4) Conceding that damages for injury to credit may in some instances be recovered, the evidence in this case is wholly insufficient to warrant a recovery by complainant of any damages for the alleged injury to his credit or financial standing because of the nonpayment of his personal obligations as they matured.

(5) Conceding, also, that anticipated profits to be realized from the completion of a contract may in proper cases be recovered as damages upon a breach of the contract by one of the parties thereto, the evidence in this case is not

sufficient to warrant a recovery by complainant of any sum as profits that he claims would have been realized if more lands had been bought; nor is there any competent evidence to show that there would have been any such profits, nor that sales of the lands actually purchased would have been effected at a profit if more lands had been purchased, nor that sales of lands purchased were retarded or prevented because of defendant's failure to furnish additional money to pay for lands actually bought, or for other lands that might have been bought.

(6) It appears that complainant had purchased lands at Gull Lake, Minn., which is near Lake Mille Lacs, at or about the time of the purchase of the Lake Mille Lacs land. It does not appear what portion of his expense of trips to Minnesota were in connection with the purchase or handling of the Gull Lake lands. For such portion of the expenses complainant is not entitled to recover; nor is he entitled to recover for the following items, included in the statement of his account: Protest of \$8,500 draft, \$2, because said draft was not authorized by defendant. Expense of trip to New York, \$90.11, because said trip was not authorized by defendant. Expense of trip to Ft. Dodge, in June, 1905, \$27.60; expense of trip to Ft. Dodge, in November, 1905, \$27.60; expense of trip to Ft. Dodge, in June, 1906, \$35—the last three items obviously being the expenses of complainant in attending to this suit in this court. Expense of trip to Algona, January, 1903, \$26; expense of trip to Des Moines, January, 1905, \$20; miscellaneous expenses charged April 1, 1906, \$200—because it does not appear that all or any of said expenses were incurred only in the purchase or care of the lands in question. There are some other items for which it is not clear that complainant is entitled to recover.

(7) That the lands actually purchased or contracted for by complainant and described in the bill of complaint, to which he holds the proper evidence of title, be sold at public sale, subject to the prior liens upon said lands other than taxes then due and payable, by a special master to be appointed by the court, and that the proceeds arising from such sale be deposited with the clerk of this court to be applied in payment: (1) Of the taxes due and payable upon said lands at the time of such sale. (2) To complainant the amount of taxes paid by him upon said lands, with interest thereon from the time of such payment at 6 per cent. per annum. (3) To complainant for the actual and necessary expenses incurred by him in purchasing or contracting for said lands only, and caring for the same, with 6 per cent. interest upon the amount of such expenditures from the time they were made. The three items above named to be first paid from said proceeds. (4) To defendant the \$2,500 advanced by him to complainant July 20, 1903. (5) To complainant the amounts advanced by him upon the purchase price of said lands actually bought or contracted for by him, and to which he holds the proper evidence of title. Items 4 and 5 to be paid without priority to either, after items 1 to 3, inclusive, are paid. (6) To complainant interest upon the amounts so advanced by him upon said purchase price of lands at 6 per cent. per annum from the time of such advancements. (7) To defendant interest upon said \$2,500 from July 20, 1903, at 6 per cent. per annum. Items 6 and 7 to be paid after items 1 to 5, inclusive, are paid. (8) To complainant an amount equal to the interest so paid to defendant and complainant under items 6 and 7 hereof, if said items are paid in full. (9) If there shall be any sum remaining of said proceeds after paying items 1 to 7, inclusive, in full, and item 8, it shall be divided equally between complainant and defendant. (10) If the proceeds of said sales shall not be sufficient to pay in full items 4 and 5, after paying items 1 to 3, inclusive, then the loss shall be borne equally by complainant and defendant, and judgment or decrees may be entered to effect such equal loss. (11) If such proceeds shall be sufficient to pay in full items 1 to 5, inclusive, but not items 6 and 7 in full, then the surplus, after paying items 1 to 5, inclusive, shall be applied first to pay the interest to complainant under item 6, and the remainder, if any, to pay the interest to defendant under item 7, and nothing shall be paid to complainant under item 8; but, if such proceeds shall be insufficient to pay in full the interest to complainant under item 6, then complainant may have judgment for such deficiency against defendant Clarke.

(8) The parties may agree upon a special master to make the sale, or, in the absence of such agreement, the court will appoint one.

(9) A large part of complainant's testimony bears upon his claim for alleged profits, for the alleged injury to his credit, and for services in buying the lands, for none of which he is entitled to recover. The complainant and defendant will each pay the cost and expenses of taking the testimony in his own behalf, and one-half of all other costs, including the costs, fees, and expenses of the special master in selling the lands.

(10) Jurisdiction of the suit is retained for the purpose of making any further orders necessary to carry into effect the decree herein ordered and to determine the amounts actually paid by complainant for lands purchased or contracted for by him to which he [holds] the title and the actual and necessary expenses incurred by him in purchasing or caring for said lands only, and any other order necessary or proper to be made to effect a final adjustment and settlement of this controversy between complainant and defendant.

A decree may be prepared accordingly, in which an exception may be saved to each party.

Supplemental Opinion.

The complainant has filed an application for a modification of the decree as ordered in the memorandum opinion of January 28, 1907, which is in effect a petition for rehearing. The bill of complaint is framed upon the theory that the contract between complainant and defendant is one of partnership, and the prayer is for a dissolution of such partnership, and for an accounting, and complainant's contention is that he is entitled to judgment against defendant Clarke for the full amount advanced by him upon the purchase of lands, including his expenses and taxes paid, with 8 per cent. interest thereon, and that defendant's interest in the lands should be only in the proportion of \$2,500 (the amount advanced by defendant) to \$12,000, which complainant says is the value of his services, in purchasing the lands, and is his [contribution] to the capital of the alleged copartnership; that the proceeds arising from the sale of the lands should be applied, first, to pay complainant \$9,500, as the alleged excess of capital contributed by him over the \$2,500 contributed by Clarke; second, to pay defendant the \$2,500 contributed by him with 6 per cent. interest thereon; third, to pay complainant an amount equal to any interest so paid to defendant; fourth, that the remainder of said proceeds should be divided equally between complainant and defendant; and that from the remainder of the proceeds so allotted to defendant should be paid (1) all taxes due upon the land at the time of the sale thereof by the special master, and the costs of this suit, including the costs and fees of the special master; (2) to complainant the amount advanced by him for the purchase of the lands including expenses, and taxes paid by him, and interest, which he claims amounts to \$11,669.33; and that he have execution over against defendant Clarke for any deficiency remaining unpaid of said amounts after so applying the proceeds to be allotted to defendant Clarke. (See ninth paragraph of the decree proposed by complainant.)

This contention is based upon the theory that as Clarke was to advance the purchase price of the lands, including taxes and expenses, and did not do so, except to the amount of \$2,500, the complainant is entitled to recover these amounts because of the breach of the contract by defendant. But, if Clarke is compelled to pay complainant the full amount of the purchase price of the lands and all taxes and expenses and interest thereon, it cannot be that complainant is further entitled to recover \$12,000, or any other sum, as the alleged value of his services in making the purchases, and to have his interest in the lands decreed to be in the [proportion] of \$12,000, the alleged value of his services, to \$2,500, the amount advanced by defendant, or nearly five-sixths of the value of the lands. The mere statement of the complainant's contention shows that it is wholly untenable. If, under any circumstances, it could be held that complainant was entitled to recover anything for his services, other than as provided in the contract, the evidence is wholly insufficient to enable the court to fix the value thereof. It is true that complainant testified that his services in purchasing said lands were worth \$12,000, and that defendant has offered no testimony in opposition thereto; but the mere fact that complainant has so testified is not of itself sufficient to enable him to recover that amount. He does not state the time required or spent by him in

making such purchases, the value of such time, nor in what respect the title to the property was so intricate or complicated as to call for extraordinary skill or service in purchasing the lands.

The twenty-fifth interrogatory to complainant and his answer thereto, which was taken upon commission, are as follows: "Question 25. State what your services were worth in purchasing the said land, and perfecting the titles thereto, and caring for and protecting the same, and in your efforts to purchase the additional lands within two miles of the west side of said Lake Mille Lacs. State, if you know, and, if so, how much said services are worth. Answer. I do know how much said services are worth. It required a peculiar and particular service, tact, and skill to hunt up the owners and buy the lands at a reasonable price, as the least excitement in regard to development would send the prices up to \$100 an acre; for on some portions of the shore on said Lake Mille Lacs lands have been sold at \$100 an acre, and the owners of the land around that lake are expecting to get \$100 an acre and more for their land, and more, whenever development is started there. There was a vast volume of correspondence in connection with said lands, and some of the titles were complicated, and required particular knowledge of real estate law to get them perfected, and in order to purchase said land and get good titles thereto it required knowledge and experience and skill of both real estate business and real estate law, and my services were worth \$12,000, no part of which has ever been paid by said A. D. Clarke or any person for him." This is the entire testimony as to the nature and value of the complainant's services, for which he claims \$12,000. The contract is dated April 14, 1903, and from the statement of complainant's expenses in the bill of complaint it appears that he made five trips from Topeka, Kan., to Minnesota in 1902 and 1903, and two in 1904, in connection with these Lake Mille Lacs lands, assuming that all of these trips were in connection therewith. But the time actually spent or required for all or any of these trips is not shown. The greater part of the land was bought or contracted for before the date of the contract, April 14, 1903. Beginning with complainant's letters to Clarke, December 31, 1902, and continuing to April 25, 1903, he complains of being sick and confined to his room a good deal of the time, and unable to do any business, and, when not so confined, of being so pressed with other important matters that he had but little time to attend to the Mille Lacs land. Being thus unable to attend to these matters, and in view of the entire absence of testimony showing the time actually spent by him in purchasing and caring for these lands, it is plain that he is not entitled to recover \$12,000 as the value of his services in purchasing and caring for these lands.

Not only this, the question calls for the value of his services in the effort to purchase other lands, as well as in the purchases actually made. The answer includes the value of such services, and there is no separation of the value of the services for each. The complainant under the contract is to be reimbursed only for the value of his services in the purchase of lands actually bought, and not for the value of efforts to buy other lands. There is not, therefore, any competent evidence in the record upon which to base an estimate of the value of complainant's services in purchasing the lands, even if he was entitled to recover therefor. But under the contract the complainant is not entitled to recover for such services. He drew the contract himself, and his understanding of what he intended by its terms appears from his letter to Clarke of March 9, 1903. In this letter he says: "You said you would like to go in with me on all that land on that lake on the plan that we talked over last fall; that is, you furnish the money to buy the land and pay the taxes and all actual cash expenses, I to do the buying and selling and looking for the lands, then out of the first money received you to have your money back and 6 per cent. interest per annum thereon for the time it was used, then I to have for my services the same amount you receive in interest, and then the balance received to be divided equally between us as profits. That puts my work and skill and services against the use of your money, only it gives you the advantage of first getting your money back and 6 per cent. interest thereon, before I get anything for my work and services; that is, I take the second chance of getting anything for my work and services, and then we equally take the third chance on a division of the profits. But I am

so well satisfied that it will be a paying investment that I am willing to take that second chance; for I believe that with any sort of development that land will bring \$100 an acre, and if you should build a trolley line out there it would bring from \$100 to \$500 an acre. The contract is drawn accordingly. The conclusion, therefore, is unavoidable that the complainant was to put his time in buying and caring for these lands against the use of the money to be advanced by defendant for its purchase; that defendant was to be first repaid the amounts so advanced by him from the proceeds of the lands when sold, and then 6 per cent. interest thereon, before complainant was to receive anything for his services; and that the value of such services was to be measured by the amount of the interest so to be received by defendant. In other words, complainant was to take, as he says, the second chance of receiving anything out of the profits of the adventure for his services after the amount of the investments was repaid to the defendant.

It is said, however, that this was to be done only in the event that defendant complied with his part of the contract. But the defendant only agreed to pay the cost of the lands upon request of complainant and the production of receipts or vouchers showing the amount paid and expended by him in so doing. If said amounts had been advanced by defendant, it is unquestioned that the same, with interest, would have to be repaid to him from the proceeds of the land, when sold, before complainant would be entitled to receive anything for his services or otherwise. Complainant having paid the same, the repayment of said amounts to him, instead of to the defendant, would leave the net result upon the profits or loss of the venture unaffected. The true measure, then, of complainant's damage for defendant's failure to pay the purchase price of the lands is the legal or agreed rate of interest. So confident was complainant that there would be a profit upon the venture that nothing is said in his letter to Clarke, nor in the contract, of there being a loss, instead of a profit. If the contract is one of partnership, as complainant contends, then the partners are each liable for their proportionate share of the losses of the venture, though it is not so specified in the agreement. This was so conceded upon the argument at the bar. The agreement to share profits implies an agreement to share the losses, unless a contrary intent appears. *Johnson Bros. v. Carter*, 120 Iowa, 355, 94 N. W. 850; *Miller v. Hughes*, 1 A. K. Marsh. (Ky.) 181, 10 Am. Dec. 719; *Meriden Bank v. Galluadet*, 120 N. Y. 298, 24 N. E. 994; *Fleming v. Lay*, 109 Fed. 952-955, 48 C. C. A. 748; *Pirtle v. Penn*, 3 Dana (Ky.) 247, 28 Am. Dec. 70. The rights of third parties are not involved, and, whether the contract is one of partnership or not, its fair import is that the parties thereto are to receive the benefits of any profits and bear the burden of any losses that may result from their venture.

Item 11 of the seventh paragraph of the memorandum opinion provides that complainant shall recover of defendant Clarke any deficiency remaining of the interest awarded to complainant under item 6, after applying the proceeds as there directed. Under the contract defendant was to advance, upon request of complainant, the amount of the cost of the lands, and, if he had done so, defendant would have been the loser of the interest upon the investment, if the lands, when sold, did not sell for enough to pay all of such interest, and complainant would lose his time. The complainant has paid for the lands, except \$2,500 advanced by defendant, and unless he recovers interest upon the amount so advanced by him he will lose, not only his time, but the interest, which would have been defendant's loss if defendant had complied with his part of the contract. The complainant, therefore, is entitled to recover from defendant any deficiency of the interest upon the amount advanced by him that he does not receive from the proceeds of the land.

The claim of complainant to interest at the rate of 8 per cent. is based upon an alleged agreement in writing of defendant to pay interest at that rate. The legal rate of interest in Iowa and Minnesota is 6 per cent. per annum, but a greater rate may be contracted for in writing in Iowa, not to exceed 8 per cent. per annum. Code Iowa 1897, § 3038. The alleged written agreement relied upon by complainant is in the letters of defendant, dated June 16, June 22, and September 2, 1904. These letters are in answer to those of complainant, dated June 15, June 20, and August 31, 1904, urging payment by Clarke of the amounts advanced for the lands. The letters of defendant show a willingness

to pay interest at 8 per cent. if complainant would extend the time of payment. The letters of complainant do not show an assent to this proposition. On the contrary, they more persistently urge payment by defendant, and threaten to draw upon him if he does not comply with complainant's demands, and finally complainant did make the draft for \$8,500. An agreement, to be binding, must be the mutual agreement of both parties. These letters do not show such an agreement, and complainant is therefore entitled to only 6 per cent. interest upon his advancements.

The complainant contends that the items of expenses claimed by him for trips and expenses (referred to in paragraph 6 of the memorandum opinion) were all incurred in connection with the purchase of these lands, and that none of them relate to the Gull Lake lands. The defendant does not dispute this, and complainant will therefore be allowed for his expenses as claimed, except those items which are disallowed by the sixth paragraph of the memorandum opinion.

Other matters referred to in the application for a modification of the opinion need not be considered. The application is denied.

WOLDSON v. LARSON.

(Circuit Court of Appeals, Ninth Circuit. October 5, 1908.)

No. 1,544.

1. COURTS (§ 372*)—FEDERAL COURTS—FOLLOWING STATE DECISIONS.

The question of the measure of damages recoverable in an action of tort, where not governed by the state Constitution or statutes, is one of general jurisprudence, upon which state decisions are not controlling on the federal courts.

[Ed. Note.—For other cases, see Courts, Cent. Dig. § 979; Dec. Dig. § 372.*

State laws as rules of decision in federal courts, see notes to *Wilson v. Perrin*, 11 C. C. A. 71; *Hill v. Hite*, 29 C. C. A. 553.]

2. HUSBAND AND WIFE (§ 334*)—ACTIONS OF TORT—EXEMPLARY DAMAGES.

It is a settled rule of the common law as administered by the federal courts that in an action for a tort, such as the alienation of the affections of the plaintiff's wife, exemplary damages are recoverable.

[Ed. Note.—For other cases, see Husband and Wife, Cent. Dig. § 1125; Dec. Dig. § 334.*]

3. HUSBAND AND WIFE (§ 333*)—ALIENATING AFFECTIONS—ACTION—EVIDENCE.

In an action for alienating the affections of plaintiff's wife and debauching her, a decree of divorce, obtained by plaintiff since the acts complained of, is admissible in evidence for the purpose of showing a severance of the relations between him and his wife.

[Ed. Note.—For other cases, see Husband and Wife, Dec. Dig. § 333.*]

4. HUSBAND AND WIFE (§ 326*)—RIGHT OF ACTION.

A husband is not precluded from recovering damages for the debauching of his wife by the fact that he saw her meet defendant at night, and might have prevented the injury complained of, unless he connived at it.

[Ed. Note.—For other cases, see Husband and Wife, Dec. Dig. § 326.*]

5. HUSBAND AND WIFE (§ 335*)—INSTRUCTIONS—"CONNIVANCE."

An instruction in an action for debauching plaintiff's wife held to correctly and sufficiently define the word "connivance," as applied to the facts in evidence.

[Ed. Note.—For other cases, see Husband and Wife, Dec. Dig. § 335.*

For other definitions, see Words and Phrases, vol. 2, p. 1435.]

*For other cases see same topic & § NUMBER in Dec. & Am. Digs. 1907 to date, & Rep'r Indexes

6. MARRIAGE (§ 50*)—PROOF OF MARRIAGE—SUFFICIENCY.

A marriage may be proved by the testimony of one of the parties that they were married by a priest and proof that they lived together as husband and wife for a number of years, where a statute of the state provided that the validity of a marriage should not be affected by the want of jurisdiction of the judge, justice, or minister who solemnized the same, if consummated with the belief of the parties, or either of them, that they were lawfully married.

[Ed. Note.—For other cases, see Marriage, Cent. Dig. §§ 79-89; Dec. Dig. § 50.*]

In Error to the Circuit Court of the United States for the Eastern Division of the Eastern District of Washington.

Wm. Wallace, Jr., M. S. Gunn, C. S. Voorhees, and Reese H. Voorhees, for plaintiff in Error.

F. H. Graves, W. G. Graves, B. H. Kizer, and J. M. Simpson, for defendant in Error.

Before GILBERT, ROSS, and MORROW, Circuit Judges.

GILBERT, Circuit Judge. For alienating his wife's affections and debauching her the defendant in error obtained a judgment against the plaintiff in error for the sum of \$9,125 and costs. Error is assigned to the instruction to the jury permitting them to award punitive damages. It is the general rule that damages which may be recovered in this class of cases are exemplary rather than compensatory. 21 Cyc. 1628; 8 Am. & Eng. Enc. of Law (2d Ed.) 266. And the Supreme Court has said, in *Day v. Woodworth*, 13 How. 371, 14 L. Ed. 181:

"It is a well-established principle of the common law that in actions of trespass, and all actions on the case for torts, a jury may inflict what are called exemplary, punitive, or vindictive damages upon a defendant, having in view the enormity of his offense, rather than the measure of compensation to the plaintiff."

The same was held in *Lake Shore, etc., Co. v. Prentice*, 147 U. S. 101, 107, 13 Sup. Ct. 261, 37 L. Ed. 97, and *Scott v. Donald*, 165 U. S. 58, 17 Sup. Ct. 265, 41 L. Ed. 632.

But the plaintiff in error contends that a different rule has been established by a decision of the Supreme Court of the state of Washington, and that a federal court within that state is bound to follow the law so established. The decision referred to is *Spokane Truck & Dray Co. v. Hoefer*, 2 Wash. St. 45, 25 Pac. 1072, 11 L. R. A. 689, 26 Am. St. Rep. 842. In that case the court, after alluding to the diversity of opinion on the question whether or not exemplary damages were recoverable, and admitting that the weight of authority seemed to be in favor of the allowance thereof, declared that, as the question was new in that state, its investigation was approached untrammelled by former decisions, and that the court was free to accept the reasoning which most strongly appealed to the judgment, and it announced its conclusion that the doctrine of punitive damages "is unsound in principle and unfair and dangerous in practice." In so holding the court declared a principle of general law which did not involve the construction of the state Constitution or statutes, or the consideration of local customs or estab-

*For other cases see same topic & § NUMBER in Dec. & Am. Digs. 1907 to date, & Rep'r Indexes

lished rules of property. In such a case the federal courts are not bound to follow the decisions of the highest courts of the state. *B. & O. Railroad v. Baugh*, 149 U. S. 368, 13 Sup. Ct. 914, 37 L. Ed. 772; *Gibson v. Lyon*, 115 U. S. 439, 6 Sup. Ct. 129, 29 L. Ed. 440; *Carroll County v. Smith*, 111 U. S. 556, 4 Sup. Ct. 539, 28 L. Ed. 517.

But the plaintiff in error argues that the Supreme Court of Washington in the decision above cited has declared the public policy of the state as to the question here under consideration, and cites *Hartford Ins. Co. v. Chicago, etc., Ry. Co.*, 175 U. S. 91, 20 Sup. Ct. 33, 44 L. Ed. 84, in which it was held that questions of public policy as affecting liability for acts done within one of the states of the Union, when not controlled by the Constitution, laws, or treaties of the United States, "or by the principles of the commercial or mercantile law, or of general jurisprudence of national or universal application, are governed by the law of the state as expressed in its Constitution and statutes or declared by its highest court." In answer to this it is sufficient to say that the decision of the present question is controlled by "principles of general jurisprudence," as declared by the decisions of the Supreme Court of the United States above cited, in which it was held to be a principle of the common law to be administered in federal courts that exemplary damages shall be allowed in cases of tort, such as libel, slander, seduction, etc., where the wrong done to the plaintiff is incapable of being measured by money standard and the damages assessed depend on the degree of moral turpitude or atrocity of the defendant's conduct.

A copy of the decree of divorce between the defendant in error and his wife was admitted in evidence. It is contended that this was error, for the reason that a judgment in a suit is not evidence in another suit against one who was not a party to it. We think there can be no question of the competency and materiality of proof that the plaintiff in such action as this has, since the occurrence of the tort complained of, obtained a divorce from his wife. It is proper for him to show that the wife whom he claims has been debauched no longer sustains that relation to him, and the best proof of that fact is the decree of divorce. In *Lee v. Hammond*, 114 Wis. 550, 90 N. W. 1073, it was said:

"The admissibility of such evidence seems to be unquestioned, and is generally assumed."

Of course, the decree was not admissible for the purpose of showing the ground on which the divorce was obtained, nor as proof of the act with which the plaintiff in error was charged; and the court properly so ruled.

But it is urged that there was error in admitting it in the present case, for the reason that counsel for defendant in error announced that it was offered "for the purpose of showing that there was a divorce granted because of this very thing." The decree of divorce, however, is silent on the subject of the ground on which divorce was decreed. All that appears from it is that the case came on to be heard on the plaintiff's complaint and the defendant's answer and cross-complaint, that the bonds of matrimony between the parties were dissolved, and that the custody of the minor children was awarded to the defendant in error herein. If there was error, therefore, it was in the statement of

counsel in declaring the purpose of the proffered proof. His language in so doing was not excepted to, nor was any motion made to strike it out. But, even if the decree showed or tended to show the relations between the plaintiff in error and the wife of defendant in error, there would seem, from the record before us, to have been no error in its admission, for it was merely cumulative proof of a fact well established in the evidence and not denied by the plaintiff in error. There was the testimony of the defendant in error that he discovered his wife and the plaintiff in error in bed together in a room in a hotel, the testimony of others who saw them in the room together, and the testimony of two witnesses who testified to admissions severally made to them by the plaintiff in error of the commission of the acts with which he is charged, none of which was denied by the plaintiff in error or by any witness.

Error is assigned to the refusal of the court to give certain instructions in relation to the facts testified to by the defendant in error. He testified in substance that he had formerly been in partnership with the plaintiff in error; that on August 6, 1904, he and his wife and their two children were living in a lodging house; that at about 7 o'clock in the evening of that day his wife, in company with a Mrs. Hanson, went out and did not return until about 2:30 o'clock in the morning; that he was awake waiting for her, and was lying undressed on his bed; that directly after his wife and Mrs. Hanson came into the building he heard some one going out, and, opening the blind of his bedroom window, he saw his wife going down the sidewalk, and saw the plaintiff in error standing on the corner near by; that he dressed hurriedly and went down to the corner, but that they had disappeared; that he went back to his room, not knowing what to do, and stayed with his children until early in the morning; that at 6 in the morning he arose and dressed and made inquiries of Mrs. Hanson, and from information derived from her he went to the Pacific Hotel, where he inquired whether or not his wife had stayed there that night; that he got the number of the room of the plaintiff in error, and, finding a ladder in the hall, used it to look over the transom, where he saw plaintiff in error and his wife in bed together. The defendant in error had alleged in his complaint that the acts with which the plaintiff in error was charged were done without his privity or consent. The answer was a general denial. The plaintiff in error for his defense relied upon connivance on the part of the husband, and it was the theory of his counsel that the defendant in error sent his wife to hunt up the plaintiff in error and obtain money from him in any way she could, by having sexual intercourse with him if necessary. It was in relation to these defenses that the instructions were requested. The court properly instructed the jury on all the essential features involved in the case, and charged them that connivance on the part of the defendant in error would bar recovery. He did not, however, instruct as requested:

"If you find from the evidence that the plaintiff had it in his power to prevent the debauchery of his wife, and neglected to do so, he could recover at most only the actual pecuniary damages he sustained."

The court had told the jury that if the husband sent his wife to the defendant in order to borrow money, contriving at the wife's undoing,

or intending that she should be undone if necessary to obtain the money, or contemplating that result, it would be connivance. The theory upon which the instruction so refused was requested was that the defendant in error heard his wife leave the house, and saw her join the plaintiff in error, and then and there could have stopped her, and could have prevented her debauchery at the hotel, and that it was his duty then and there so to do. We do not conceive that the requested instruction embodies a hard and fast rule of law applicable under all circumstances, or that there was error in its refusal in the present case. In 2 Bishop on Marriage and Divorce (6th Ed.) § 9, it is said that a husband who suspects his wife "may watch her and even leave open the opportunities which he finds, but he must not make new ones or lay temptations in her way"; and such is the doctrine of the decisions in *Lee v. Hammond*, 114 Wis. 550, 90 N. W. 1073, *Wilson v. Wilson*, 154 Mass. 194, 28 N. E. 167, 12 L. R. A. 524, 26 Am. St. Rep. 237, *Puth v. Zimbleman*, 99 Iowa, 641, 68 N. W. 895, and many other cases.

It is contended that the court erred in refusing to define the word "connivance" as requested by the plaintiff in error, and as defined in *Black's Dictionary*, as follows:

"You are instructed that connivance is the secret or indirect consent or permission of one person to the commission of an unlawful or criminal act by another. It consists of a winking at or an intentional forbearance to see a fault or other act."

The definition given by the court was taken from *Bouvier's Dictionary* as follows:

"It is an agreement or consent, indirectly given, that something unlawful may be done by another. This is its application to the matter before you."

It is urged that the definition as given failed to advise the jury that there might be a passive connivance, a consent of the mind. But a consent of the mind can only be evidenced by the acts and conduct of the person whose mind consents. The instructions given by the court sufficiently advised the jury of the meaning of the term "connivance," in view of the evidence in the case, if indeed, the word needed definition.

Error is assigned to the refusal of the court to instruct the jury to return a verdict for the plaintiff in error for the want of sufficient proof of a valid marriage, and on the ground that the uncontradicted evidence of the defendant in error showed such conduct on his part as to bar recovery. As to the marriage, the testimony of the defendant in error was that on April 3, 1891, he and his wife were married in the house of a Catholic priest in Missoula, Mont.; that a regular ceremony was performed; that he and his wife stood up before the priest, and that the priest married them. The plaintiff in error, apparently satisfied with this proof, made no effort to elicit further facts in regard to the nature of the ceremony, and offered no proof to rebut the same. It is shown, further, that from the time of the marriage the defendant in error and his wife lived together as husband and wife, and were known as such. A statute of Montana, in force at the time of the marriage, provided that the validity of a marriage solemnized before a judge, justice, or minister should in no way be affected on account of

want of jurisdiction or of authority, "provided it be consummated with the full belief on the part of the persons so married, or either of them, that they have been lawfully joined in marriage." We think the proof in the present case was sufficient to justify the jury in finding that there was a marriage. *Fleming v. People*, 27 N. Y. 329; *People v. Calder*, 30 Mich. 85; *Kilburn v. Mullen*, 22 Iowa, 498; *Jacobsen v. Siddal*, 12 Or. 280, 7 Pac. 108, 53 Am. Rep. 360.

Nor does it appear that the case should have been taken from the jury on the other ground suggested in the motion. It is unnecessary to review the evidence in detail. If the jury believed the testimony of the defendant in error, and from their verdict they must have believed it, there was in it sufficient to show that he did not contrive for his wife's downfall, and that he did not suspect her of intimacy with the plaintiff in error until he heard her leave the house in the early morning of August 7th, and saw her join the plaintiff in error on the street corner some 150 feet away. His testimony is susceptible of the construction that he did not connive in her undoing or consent thereto. It is argued that he might have shouted from his window, or otherwise might have detained his wife on her way to join her paramour; but it is to be said in answer to this that it does not appear that he had reason to know what she intended to do, and his testimony was that, when he hurriedly dressed and pursued her, she and the plaintiff in error had disappeared, and he had no clue as to their whereabouts.

We find no error for which the judgment should be reversed. It is accordingly affirmed.

In re FISH BROS. WAGON CO.

(Circuit Court of Appeals, Eighth Circuit. October 23, 1908.)

No. 88, Original.

1. BANKRUPTCY (§ 207*)—GENERAL ASSIGNMENT—LIENS ACQUIRED BY ASSIGNEE.

A title or lien acquired by an assignee under a general assignment valid according to the law of the state where it is made, that is to the advantage of the estate when it has subsequently passed into bankruptcy, is not necessarily destroyed by the supersession of the assignment proceeding; but upon the order of the court of bankruptcy it may be retained by the trustee for the benefit of the creditors.

[Ed. Note.—For other cases, see Bankruptcy, Dec. Dig. § 207.*]

2. BANKRUPTCY (§ 140*)—LIENS—CONDITIONAL SALE CONTRACT.

Under the law of Kansas, by decision, an assignee under a general assignment represents, not only the assignor, but his creditors as well, and as such representative acquires title to the assigned property, which is good as against a contract of conditional sale not filed as required by statute. *Held*, where a debtor in Kansas made a general assignment under the state law and was subsequently adjudicated a bankrupt, that under Bankr. Act July 1, 1898, c. 541, § 67a, 30 Stat. 564 (U. S. Comp. St. 1901, p. 3449), which provides that "claims which for want of record * * * would not have been valid liens as against the claims of the creditors of the bankrupt shall not be liens against his estate," the right of the creditors, through the assignee, as their representative, to property

*For other cases see same topic & § NUMBER in Dec. & Am. Digs. 1907 to date, & Rep'r Indexes

held by the bankrupt under an unrecorded contract of conditional sale, could be enforced by the trustee under subdivision "b" of said section.

[Ed. Note.—For other cases, see Bankruptcy, Dec. Dig. § 140.*]

On Petition to Revise.

Samuel Feller, Edwin A. Krauthoff, Arthur Miller, and Karnes, New & Krauthoff, for petitioner.

George W. Freerks, M. C. Freerks, and Ed. R. Bane, for respondent trustee.

Before SANBORN and HOOK, Circuit Judges, and PHILIPS, District Judge.

HOOK, Circuit Judge. This is a proceeding to revise in matter of law an order of a court of bankruptcy denying the petition of the Fish Bros. Wagon Company for the possession of certain personal property. The wagon company sold and delivered some of its manufactured products to R. P. Roark & Co., a partnership at Scott City, Kan., under a written contract which manifestly is a contract of conditional sale, and not one of bailment, as contended. There was no deposit of the contract or copy thereof with the register of deeds of the county in which the property was kept, and therefore under a Kansas statute (section 4523, Gen. St. 1905) the contract was "void as against innocent purchasers or the creditors" of the vendees. In this situation the vendees, Roark & Co., made a general assignment for the benefit of creditors as authorized by the state law, and a few days later they were adjudged bankrupts in an involuntary proceeding. A trustee in bankruptcy was thereafter duly selected. The wagon company, claiming under the contract, petitioned the referee in bankruptcy for the possession of the goods, and the trustee asked that what he termed the lien of the assignee under the general assignment be kept alive for the benefit of the creditors in the bankruptcy proceeding. The referee denied the petition of the wagon company and sustained that of the trustee. The order of the referee was affirmed by the District Court.

Were it not for the intervention of the assignment between the making of the contract of conditional sale and the bankruptcy proceeding, the right of the wagon company would be clear. Under the Kansas statute the failure to deposit the contract or copy with the register of deeds did not make the instrument invalid as between the parties to it, but only so as to innocent purchasers and creditors of the vendees. The term "creditors" means those having some specific lien upon or right to the property involved and not mere general creditors. This was held to be so in a case involving the Kansas statute requiring the filing of chattel mortgages (*Youngberg v. Walsh*, 72 Kan. 220, 83 Pac. 972); and as the language of that statute and of the one relating to contracts of conditional sale is similar, and their purpose is the same, the same construction should be adopted. It is well settled that a trustee in bankruptcy is not an innocent purchaser or a lien creditor, but that generally speaking, he takes only such rights as the bankrupt himself had. *York Mfg. Co. v. Cassell*, 201 U. S. 344, 26

*For other cases see same topic & § NUMBER in Dec. & Am. Digs. 1907 to date, & Rep'r Indexes

Sup. Ct. 481, 50 L. Ed. 782. Attention therefore turns to the effect of the general assignment and the provisions of section 67 of the bankruptcy act (Act July 1, 1898, c. 541, 30 Stat. 564, 565 [U. S. Comp. St. 1901, p. 3449]); and the inquiry is whether the trustee is in a better position than he would have been without them.

The general doctrine is that an assignee in a general assignment under a state statute is neither an innocent purchaser nor a creditor having a lien on the assigned property, but that, like a trustee in bankruptcy, he stands in the shoes of his insolvent and is possessed of no greater right. It seems, however, to be otherwise in Kansas. In *Withrow v. Citizens' Bank*, 55 Kan. 378, 40 Pac. 639, it was held that an assignee is not merely the representative of the debtor but is also a trustee for the creditors, in whom title is vested by the deed of assignment, and that an unfiled chattel mortgage is void as against the right so secured by him. The effect of the assignment in question here is to be determined by the Kansas law (*First Nat. Bank v. Staake*, 202 U. S. 141, 26 Sup. Ct. 580, 50 L. Ed. 967), and it is the same upon an unfiled contract of conditional sale as upon an unfiled chattel mortgage. So, had no bankruptcy proceeding been instituted, the assignee would have prevailed over the wagon company in a contest for the possession of the property. Is the right of the assignee available to the trustee, or was it wholly destroyed by the bankruptcy proceeding?

The trustee relies upon subdivisions "a," "c," and "f" of section 67 of the bankruptcy act. The last of these authorizes the preservation, for the benefit of the bankrupt estate, of liens obtained, through legal proceedings against the insolvent debtor within four months prior to the filing of a petition in bankruptcy against him, and subdivision "c" provides for the subrogation under certain conditions of the trustee to the rights of one who acquires a lien by a suit or proceeding at law or in equity begun against the debtor within the four months' period. There is difficulty in the application of these provisions to the case at bar. Although the right of the assignee under the assignment might be called a "lien" in the sense that it is a right to resort to specific property for the satisfaction of the debts of the assignor, and is therefore a charge upon such property, and while the assignment proceeding considered in its entirety may be termed a "legal proceeding," because under the Kansas law it is conducted in a court of record, yet it is a voluntary proceeding, and is not, as contemplated by the provisions of the bankruptcy act above referred to, a proceeding against the insolvent debtor. We think, however, that section 67a is sufficiently comprehensive to cover the case. It provides:

"Claims which for want of record or for other reasons would not have been valid liens as against the claims of the creditors of the bankrupt shall not be liens against his estate."

At the time of the institution of the bankruptcy proceeding the creditors, through the assignee as their representative, had obtained by the general assignment, which was entirely valid under the local law, a right to have the property now in controversy subjected to the payment of their debts, to the exclusion of the claim of the wagon company under its unfiled contract of conditional sale. Because the as-

signment was superseded by the bankruptcy proceeding, it does not follow that no rights whatever could grow out of it. True, the making of the assignment was an act of bankruptcy; but, when made, it was authorized by the law of the state, and was valid until done away with by a proceeding that took precedence. An assignment cannot be said to be absolutely prohibited by the bankruptcy act, irrespective of the institution of a bankruptcy proceeding. *Randolph v. Scruggs*, 190 U. S. 533, 537, 23 Sup. Ct. 710, 47 L. Ed. 1165. Though the title of a trustee in bankruptcy to the property he takes is not by way of succession to that of an assignee under an assignment that is superseded, yet in such cases many things done by the latter for the benefit of the estate may be retained and enjoyed by the former. As already observed, the assignee, as the representative of all the creditors, had secured a specific right in the property in controversy by a deed of assignment valid under the Kansas law; and if this right, beneficial, as it is, to the bankrupt estate, is to be stricken down, it must be because the assignment was wholly invalid for every purpose and the invalidity related back to the date of the deed. That might be so in case of actual fraud, but there was no such element in the particular transaction. In *Randolph v. Scruggs*, supra, the court, in considering the effect of a general assignment honestly made, rejected the doctrine of constructive fraud. The court said:

"It had no general fraudulent intent. It was voidable only in case bankruptcy proceedings should be begun. At the time when it was made the institution of such proceedings was uncertain. It seems to us it would be a hard and subtle construction to say, as seems to have been thought in *Bartlett v. Bramhall*, 3 Gray (Mass.) 257, 260, that when they were instituted they not only avoided the assignment, but made it illegal by relation back to its date, when, if they had not been started, it would have remained perfectly good."

Again:

"But the assignee is acting lawfully in what he does before proceedings in bankruptcy are begun, and, although it may be assumed that the avoidance of the assignment relates back to the date of the deed, still, so far as his services or services procured by him tend to the preservation or benefit of the estate, the mere fiction of relation is not enough to forbid an allowance for them."

See, also, the opinion of this court in *Summers v. Abbott*, 58 C. C. A. 352, 122 Fed. 36.

We think that a title or lien acquired by an assignee under a general assignment valid according to the law of the state where it is made, that is to the advantage of the estate when it has passed into bankruptcy, is not necessarily destroyed by the supersession of the assignment proceeding, but that upon the order of the court of bankruptcy it may be retained by the trustee for the benefit of the creditors. This conclusion is in harmony with the object sought by express provisions of the bankruptcy act for the preservation of liens obtained in judicial proceedings against the debtor, and it is a fair corollary of the settled rule allowing the assignee compensation for acts that are beneficial to the estate which afterwards passes to the trustee.

The petition is denied.

BOSTON WOVEN HOSE & RUBBER CO. v. PENNSYLVANIA RUBBER CO.

(Circuit Court of Appeals, First Circuit. July 15, 1908.)

No. 755.

1. PATENTS (§ 157*)—CONSTRUCTION OF CLAIMS—PAPER PATENTS.

The rule applied that in a suit for infringement of a patent for an alleged invention of which no practical use has ever been made, the patent is not entitled to the same breadth of construction which might be warranted by its proved usefulness.

[Ed. Note.—For other cases, see Patents, Dec. Dig. § 157.*]

2. PATENTS (§ 328*)—INFRINGEMENT—WHEEL TIRES.

The Schrader patent, No. 466,577, for improvements in wheel tires, claim 2, construed, and held not infringed.

[Ed. Note.—For other cases, see Patents, Dec. Dig. § 328.*]

Appeal from the Circuit Court of the United States for the District of Massachusetts.

For opinion below, see 156 Fed. 787.

Frederick P. Fish and W. Orison Underwood (Johnson, Clapp & Underwood, on the brief), for appellant.

Bayard H. Christy (George H. Christy, on the brief), for appellee.

Before PUTNAM and LOWELL, Circuit Judges, and ALDRICH, District Judge.

PUTNAM, Circuit Judge. This is a bill alleging infringement of letters patent No. 466,577, issued on January 5, 1892, on an application filed on December 30, 1890. The second claim only is in issue, as follows:

"2. The combination of the U-shaped tire, the felly, an inflated tube confined by said tire, and an internal clamping device, between which and the felly the U-shaped tire is secured, substantially as set forth."

The Circuit Court dismissed the bill, and the complainant appealed to us.

First of all, it is to be observed that, although the letters patent issued more than 14 years before the filing of this bill, no practical use was ever made of the alleged invention covered by the claim now in issue. Consequently the patent lacks that support coming from public acquiescence which is often of great value, not only in giving support to an alleged invention, but also in justifying a breadth of construction of the patent itself, so that the complainant is subject to the scrutiny and the limitations of the class observed on in our opinion in United States Hog Hoisting Machine Co. v. North Packing & Provision Co. (C. C. A.) 158 Fed. 818, and in the cases there cited, and in Deering v. Harvester Works, 155 U. S. 286, 295, 15 Sup. Ct. 118, 39 L. Ed. 153. Aside from that, however, we are unable to give the claim in issue such a construction as would embrace within it the respondent's device.

*For other cases see same topic & § NUMBER in Dec. & Am. Digs. 1907 to date, & Rep'r Indexes

The claim before us names six elements: (1) The U-shaped tire; (2) the felly; (3) an inflated tube; (4) the inflated tube confined by the tire; (5) the internal clamping device; and (6) the location of the clamping device in such manner that the U-shaped tire is secured between it and the felly. Two additional elements are involved in the words "substantially as set forth." The first of these is the fact that the clamping device makes a complete circle, longitudinally with the tire, wholly around the wheel, and the second is that, on a transverse line, the clamping device is crowned, or, as described in the specification, convexed. All the parts are seen in the drawing, Fig. 5, as follows:

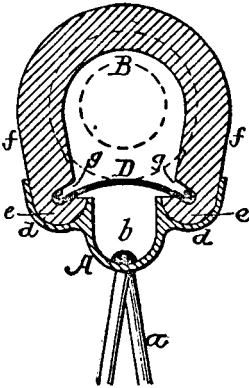

Very likely, however, it may be that this crowning is not an essential element, but only a preferable one, and therefore we will make no further observation in regard to it. There has been much discussion with reference to the question whether, in the contemplation of the inventor, the U-shaped tire means a hard rubber tire—that is, one permanently shaped—or whether it means, or may be replaced by, a flexible tire, or outside shell for the tire. The specification describes a modification showing such a flexible covering, or "strip," in the place of what is called therein "the formed tire." Inasmuch, however, as we are concerned only with the second claim, we do not perceive that we are interested in this

modified method of construction. It seems to have no bearing whatever, except that it strengthens the conclusion, which we otherwise reach, that for holding together the parts of his mechanism the patentee relies on the clamping device, and not on any inherent holding ability of the horseshoe ends of the U-shaped tire.

The case, however, comes down to the first element, which we have described as covered by the words "substantially as set forth." It is shown by the specification that, in order to hold the parts firmly together, the clamping device, or the plate, as it is sometimes called, must be continuous around the entire circumference of the wheel, and so arranged that the ends can be drawn together, thus rigidly fastening the tire to the felly. This is a positive element in the complainant's device which is lacking in that of the respondent, so that it is impossible to charge infringement.

The specification puts this in such a positive manner that we cannot waive it for the benefit of any rule whatsoever with regard to equivalents. It first says:

"I preferably convex the plate transversely, so as to stiffen the same when tension is applied, as it will be understood that this band [meaning the clamping device] extends completely around the wheel, and the two ends are secured together, thus making a rigid fastening for the tire."

The specification continues that the band may be made in sections; but even in this connection it intensifies by implication what we have

already referred to, in that it says that the sections "can be provided with a like number of securing and tightening devices." It proceeds at considerable length to describe the mechanism by which the two ends of the band, as it is called in this part of the specification, may be conveniently and firmly drawn together longitudinally, so as to make sure "the rigid fastening for the tire" to which we have already referred. Indeed, of the specification 45 lines relate to the explanation of the fact that the clamping device is a band extending longitudinally entirely around the wheel, with its ends drawn together by the mechanism described, so that, by tightening, the tire shall be rigidly secured to the felly.

It is true that, after all this, the specification suggests that the tire may be inflated by simply forcing air under pressure into the space between the band and the tire; that is, between the clamping device and the tire. It is understood, however, that this has never been successfully accomplished and is an impracticable suggestion; but it is enough for our purposes that nothing of this character is involved in claim 2.

In lieu of this continuous clamping device, the respondent relies on such a construction of the U-shaped tire that, in connection with the inflation to which it may be subjected in the respondent's method of construction, it holds itself in place without the continuous band. It is true that at certain intervals, following each other around the respondent's wheel, he has staybolts, or lugs, extending transversely from one of the horseshoe ends of the U-shaped tire to the other, which re-enforce the tendency of the tire to maintain itself in position. It cannot be doubted that, under some conditions with reference to an invention of the character involved here, the field of equivalents would be so broad that these staybolts might be held to infringe; but, under the circumstances which we have explained, we are compelled to agree with the conclusion reached by the Circuit Court.

The decree of the Circuit Court is affirmed, and the appellee recovers its costs of appeal.

In re SIEGEL.

(District Court, E. D. New York. October 16, 1908.)

BANKRUPTCY (§ 175*) — PROPERTY PASSING TO TRUSTEE — PRETENDED SALE BY BANKRUPT.

A pretended sale of goods by a bankrupt a few days prior to his bankruptcy held fraudulent and void, and to convey no title as against creditors, but merely a device to apparently transfer the title while the ownership of the goods in fact remained in the bankrupt.

[Ed. Note.—For other cases, see Bankruptcy, Cent. Dig. §§ 247, 248; Dec. Dig. 175.*]

In Bankruptcy.

*For other cases see same topic & § NUMBER in Dec. & Am. Digs. 1907 to date, & Rep'r Indexes

Cohen Bros., for trustee.
Louis Lichtenberg, for claimant.
Henry J. Bloch, for bankrupt.

CHATFIELD, District Judge. About the 10th of September, 1907, some 201 pairs of shoes were taken to the apartment of one David Palles, a workman for Abraham Siegel. The testimony shows that Siegel himself had carried these shoes to Palles' apartment. On the 23d day of September, 1907, an involuntary petition in bankruptcy was filed against Siegel, who was adjudicated on the 10th day of October, 1907; but on October 5th of that year a city marshal seized the shoes in Palles' apartment by authority of a writ of replevin obtained by one Nadler, who claimed the goods by reason of a purchase made September 10, 1907, for \$311.30. This purchase was on the same day on which the goods were taken to Palles' apartment, and the testimony shows that Siegel and Nadler were negotiating with reference to the opening of a new place of business, which the bankrupt and Nadler both claimed belonged to Nadler, but which the evidence plainly indicated was in reality the property of Siegel, for whom Nadler was a dummy. The receiver in bankruptcy demanded the shoes on motion, and the question as to whether the receiver was entitled to possession of the shoes was sent to a referee, as special commissioner.

The commissioner reported that a claim to the shoes made by Palles and his wife, the people with whom the shoes had been stored, was not substantiated; this claim having been based upon an alleged loan. The commissioner's report on this point should be confirmed. The circumstances of the alleged loan are not such as to satisfy the court that, if the money was advanced, it gave Mrs. Palles anything further than a claim against the bankrupt estate.

The commissioner further reported that Mr. Nadler had purchased the shoes in question, and that, therefore, the receiver was not entitled to them. The court then filed a memorandum to the effect that the finding of the commissioner was apparently correct, in that the question sent to him as to whether the receiver was entitled to the shoes could only be answered in the way in which he had reported; but, inasmuch as a question of title was involved, opportunity would be given to the trustee to bring such action as he might be advised, or if all of the parties, including the trustee, who had then been appointed, should consent and request the court to pass upon the issues, upon the record then before the court, and thus avoid the expense of an additional suit, the matter would be held until one course or the other was indicated. The parties, including the claimants and the trustee, have now stipulated that the court shall determine the issue of title, and the evidence seems to show with sufficient clearness that no sale to Nadler occurred which would either be valid as against creditors or which would convey title. The entire transaction between Siegel and Nadler was such that Nadler must be held to have known that he was in effect acting as a dummy, and that Siegel was planning to set up the business in Nadler's name. Nadler was, therefore, a party to the fraud, and the whole transaction should be held null and void.

Judgment may be had in favor of the trustee as against all of the parties. The question of any lien of the marshal in the replevin proceedings for his fees and disbursements will be disposed of on the settlement of the order, when further information on that subject may be furnished.

SUNSET TELEPHONE & TELEGRAPH CO. v. CITY OF POMONA et al.

(Circuit Court, S. D. California, S. D. August 31, 1908.)

No. 1,209.

1. TELEGRAPHS AND TELEPHONES (§ 9*)—TELEPHONE COMPANIES—RIGHTS UNDER FEDERAL STATUTES.

A telephone company is not within Act July 24, 1866, c. 230, 14 Stat. 221 (Rev. St. §§ 5263-5268; U. S. Comp. St. 1901, pp. 3579-3581), granting to telegraph companies who accept its conditions the right to construct their lines over the public lands and post roads; nor can a company doing both a telegraph and telephone business claim its benefit as to the lines used in its telephone business. The fact that such lines may be used for the local delivery of interstate telegraphic messages does not make them an integral part of the telegraph lines, so as to bring them within the purview of the act.

[Ed. Note.—For other cases, see Telegraphs and Telephones, Dec. Dig. § 9.*]

2. TELEGRAPHS AND TELEPHONES (§ 10*)—RIGHT TO USE STREETS.

Said act does not grant to telegraph companies the right to occupy with their poles and wires the streets of a city without the latter's consent.

[Ed. Note.—For other cases, see Telegraphs and Telephones, Cent. Dig. § 6; Dec. Dig. § 10.*]

Rights of telegraph and telephone companies to use of streets, see note to Southern Bell Tel. & Tel. Co. v. City of Richmond, 44 C. C. A. 155.]

3. TELEGRAPHS AND TELEPHONES (§ 10*)—CONSTRUCTION OF STATUTE—"HIGHWAYS."

In Civ. Code Cal. § 536, which as re-enacted March 20, 1905 (St. 1905, p. 491, c. 385), grants to both telegraph and telephone companies the right to construct their lines "along and upon any public road or highway," the word "highway" includes a street.

[Ed. Note.—For other cases, see Telegraphs and Telephones, Cent. Dig. § 6; Dec. Dig. § 10.*]

For other definitions, see Words and Phrases, vol. 4, pp. 3291-3306; vol. 8, p. 7678.]

4. COURTS (§ 366*)—FEDERAL COURTS—AUTHORITY OF DECISIONS OF STATE COURTS.

The rule that the construction of a state statute by the highest court of the state is conclusive on a federal court does not apply where a federal question is involved, as where a complainant contends that it acquired contract rights under such statute which are protected from impairment by the federal Constitution.

[Ed. Note.—For other cases, see Courts, Dec. Dig. § 366.*]

Conclusiveness of judgment as between federal and state courts, see notes to Kansas City, Ft. S. & M. R. Co. v. Morgan, 21 C. C. A. 478, and Union & Planters' Bank v. City of Memphis, 49 C. C. A. 468.]

*For other cases see same topic & § NUMBER in Dec. & Am. Digs. 1907 to date, & Rep'r Indexes
164 F.—36

5. TELEGRAPHS AND TELEPHONES (§ 10*)—STATUTES—CONSTRUCTION—"TELEGRAPH CORPORATIONS."

In Civ. Code Cal. § 536, which as it existed prior to its re-enactment March 20, 1905 (St. 1905, p. 491, c. 385), granted the right to telegraph corporations to construct their lines along and upon any public road or highway, the words "telegraph corporations" do not include a telephone company.

[Ed. Note.—For other cases, see Telegraphs and Telephones, Dec. Dig. § 10.*]

6. TELEGRAPHS AND TELEPHONES (§ 4*)—RIGHT OF WAY—CALIFORNIA STATUTES.

The California franchise act of March 22, 1905 (St. 1905, p. 777, c. 578), which provides, inter alia, that every franchise granted by the governing bodies of counties, cities, or towns to erect or lay telegraph or telephone wires, "except telegraph or telephone lines doing an interstate business," shall be granted upon the conditions in such act provided and not otherwise, by necessary implication repeals Civ. Code Cal. § 536, as re-enacted March 20, 1905 (St. 1905, p. 491, c. 385), granting the right to telegraph or telephone corporations to construct their lines along and upon any public road or highway, except as to such lines doing an interstate business.

[Ed. Note.—For other cases, see Telegraphs and Telephones, Dec. Dig. § 4.*]

7. TELEGRAPHS AND TELEPHONES (§ 10*)—UNLAWFUL OCCUPATION OF STREET.

A telephone company, which unlawfully occupies the streets of a city with its poles and wires after its franchise to do so has expired, and which has refused the demand of the city that it renew the same, is not entitled to relief in equity because the removal of such poles and wires as obstructions to the streets was ordered by a resolution, rather than by ordinance, or was otherwise informal.

[Ed. Note.—For other cases, see Telegraphs and Telephones, Dec. Dig. § 10.*]

In Equity. Suit for injunction.

Complainant, a California corporation, does a telephone business in the city of Pomona, Cal., and for this purpose has constructed and maintains its local lines running from its central station to its subscribers in said city. Complainant also does a telephone and telegraph business in the states of California, Oregon, Washington, and Nevada, under one general system, owning and using 133,000 miles of wire, of which more than 35,000 miles are used exclusively for long-distance messages, 130,000 telephones, 1,200 offices, of which 451 are exchange stations, and over 100,000 poles, and the lines of this system run into said city and terminate at said central station. Complainant claims that its local lines in Pomona are an integral part of its general telegraph system, and aid in and complete the transmission of interstate telegrams to and from its subscribers in said city.

On August 8, 1888, the city of Pomona passed an ordinance (No. 30) granting to Sunset Telephone-Telegraph Company (a corporation distinct and separate from the complainant) a franchise to erect and maintain for a period of 10 years poles and telephone wires along the streets of the city, which franchise expired by its own limitation August 8, 1898. In April, 1889, complainant was incorporated, and in May, 1889, the grantee in said ordinance transferred all of its property to complainant, and since then complainant has maintained and operated its lines in said city. From August 8, 1898, the date of the expiration of Ordinance No. 30, until about the middle of the year 1902, complainant, in extending and enlarging its system in Pomona, so as to accommodate new subscribers, expended more than \$10,000, and about May, 1904, expended more than \$6,700, in changing and reconstructing its poles and wires on Second street in said city, and in addition to said sums

*For other cases see same topic & § NUMBER in Dec. & Am. Digs. 1907 to date, & Rep'r Indexes

expended \$1,500 in extension work subsequent to October 23, 1903, and claims that said expenditures were made with the acquiescence and consent and under the direction of the city, and, further, that the expenditure of \$6,700 was made also in consideration of the recognition by the city of the right of complainant to maintain and operate its system in said city, without securing a franchise from the city.

Complainant also claims that the construction, maintenance, and operation of its lines were an acceptance of the terms of section 536 of the Civil Code of California, and an inviolable contract was thus created between the state and itself. The foregoing claims of complainant are disputed by respondent, and the court's deductions from the evidence on said issues are indicated in its opinion. The statutes construed by the court are not set forth in its opinion, and therefore copies of those most frequently referred to will be given here.

Section 536 of the Civil Code of California, as re-enacted March 20, 1905, is as follows:

"Telegraph or telephone corporations may construct lines of telegraph or telephone lines along and upon any public road or highway, along or across any of the waters or lands within this state, and may erect poles, posts, piers or abutments for supporting the insulators, wires and other necessary fixtures of their lines, in such manner and at such points as not to incommode the public use of the road or highway or interrupt the navigation of the waters."

St. Cal. 1905, pp. 491, 492, c. 385.

Prior to its re-enactment, telephone companies were not mentioned in the section.

The first section of the act of March 22, 1905, entitled "An act providing for the sale of street railroad and other franchises in counties and municipalities, and providing conditions for the granting of such franchises by legislative or other governing bodies, and repealing conflicting acts," is as follows:

"Every franchise or privilege to erect or lay telegraph or telephone wires, to construct or operate street or interurban railroads upon any public street or highway, to lay gas pipes for the purpose of carrying gas for heat and power, to erect poles or wires for transmitting electric heat and power along or upon any public street or highway, or to exercise any other privilege whatever hereafter proposed to be granted by boards of supervisors, boards of trustees, or common councils, or other governing or legislative bodies of any county, city and county, city or town within this state, except steam railroads and except telegraph or telephone lines doing an interstate business, and renewals of franchises for piers, chutes, or wharves, shall be granted upon the conditions in this act provided, and not otherwise."

St. Cal. 1905, p. 777, c. 578.

The act entitled "An act to aid in the construction of telegraph lines, and to secure to the government the use of the same for postal, military and other purposes," approved July 24, 1866 (14 Stat. 221, c. 230), and embodied in sections 5263 to 5268 of the United States Revised Statutes (U. S. Comp. St. 1901, pp. 3579-3581), is as follows:

"Be it enacted by the Senate and House of Representatives of the United States of America in Congress assembled, that any telegraph company now organized, or which may hereafter be organized under the laws of any state in this Union, shall have the right to construct, maintain, and operate lines of telegraph through and over any portion of the public domain of the United States, over and along any of the military or post roads of the United States, which have been or may hereafter be declared such by act of Congress, and over, under or across the navigable streams or waters of the United States: Provided, that such lines of telegraph shall be so constructed and maintained as not to obstruct the navigation of such streams and waters, or interfere with the ordinary travel on such military or post roads. And any of said companies shall have the right to take and use from such public lands the necessary stone, timber, and other materials for its posts, piers, stations, and other needful uses in the construction, maintenance and operation of said lines of telegraph, and may pre-empt and use such portion of the unoccupied public lands subject to pre-emption through which its said lines of telegraph may be located as may be necessary for its stations, not exceeding forty

acres for each station; but such stations shall not be made within fifteen miles of each other.

"Sec. 2. And be it further enacted, that telegraphic communications between the several departments of the government of the United States and their officers and agents shall, in their transmission over the lines of any of said companies, have priority over all other business, and shall be sent at rates to be annually fixed by the Postmaster General.

"Sec. 3. And be it further enacted, that the rights and privileges hereby granted shall not be transferred by any company acting under this act to any other corporation, association, or person: Provided, however, that the United States may at any time after the expiration of five years from the date of the passage of this act, for postal, military, or other purposes, purchase all the telegraph lines, property, and effects of any or all of said companies at an appraised value, to be ascertained by five competent, disinterested persons, two of whom shall be selected by the Postmaster General of the United States, two by the company interested, and one by the four so previously selected.

"Sec. 4. And be it further enacted, that before any telegraph company shall exercise any of the powers or privileges conferred by this act, such company shall file their written acceptance with the Postmaster General of the restrictions and obligations required by this act."

On the 14th day of December, 1897, complainant filed with the Postmaster General its written acceptance of the restrictions and obligations required by said act of Congress.

In the act of Congress entitled "An act to revise, consolidate and amend the statutes relating to the Post Office Department," approved June 8, 1872 (17 Stat. 283, 309, c. 335), and embodied in Rev. St. U. S. § 964 (U. S. Comp. St. 1901, p. 2707), is the following provision:

"Sec. 205. That all letter carrier routes established in any city or town for the collection or delivery of mail matter by carrier are hereby declared post routes."

The act of Congress entitled "An act making all public roads and highways post routes," approved March 1, 1884 (23 Stat. 3, c. 9 [U. S. Comp. St. 1901, p. 2708]), provides "that all public roads and highways, while occupied by and maintained as such, are hereby declared to be post routes."

On the 6th day of June, 1905, the board of trustees of the city of Pomona passed a resolution, of which the following is a copy:

"Whereas, the Sunset Telephone & Telegraph Company, a corporation, is now, and during all the times hereinmentioned was, engaged in local telephone business in the city of Pomona; and

"Whereas, said company obtained a right and franchise for telephone purposes only, from said city to enter and do business in said city for the period of ten years, on August 8, 1888, as evidenced by Ordinance No. 30 of said city; and

"Whereas, by the terms of said ordinance said franchise expired during the year 1898, and said company now has no franchise nor any right from said city, nor at all to use, occupy or obstruct the streets of said city for telephone purposes; and

"Whereas, the trustees of said city have repeatedly requested and still request said company to secure from said city such a franchise as will compel an observance of those or similar conditions contained in the franchise now held by the Pomona Valley Telephone & Telegraph Union, a corporation, so that there will be no discrimination between the two companies doing in competition a similar local or state business:

"Therefore be it resolved, that said Sunset Telephone & Telegraph Company be, and it is hereby, notified to appear before this board of trustees on Thursday, June 15, 1905, at 7:30 p. m., at the city hall, Pomona, California, to show cause, if any it has, why it should not obtain such franchise from said city, and upon its failure or refusal to immediately apply for and secure said franchise why the telephone poles and wires and apparatus of said company should not be declared a public nuisance, and the street superintendent of said city be instructed to remove said poles, wires and apparatus from the streets of said city; and

"Be it further resolved, that the city clerk be instructed to serve a certified copy of this resolution upon the said Sunset Telephone & Telegraph Company at its office in Pomona, California."

On the 1st day of August, 1905, said board of trustees passed a resolution, a copy of which is as follows:

"Whereas, the Sunset Telephone-Telegraph Company, a corporation, by a resolution duly adopted June 6, 1905, a certified copy of which was served on said company, cited said company to appear before this board of trustees on Thursday, June 15, 1905, at 7:30 p. m., at the city hall, Pomona, California, to show cause, if any it has, why it should not obtain a franchise from said city for the purposes stated in said resolution and citation, and upon default thereof why the telephone poles, wires and apparatus of said company should not be declared a public nuisance and removed from the streets of said city; and

"Whereas, at the time and place appointed said company failed to make any appearance in response to said resolution, and no showing at all having been made justifying its obstruction and occupancy of the streets of said city by said company:

"Therefore be it resolved, that the telephone poles, wires and apparatus of said Sunset Telephone-Telegraph Company employed in doing state and local telephone business within the city of Pomona (and not including poles, wires and apparatus used exclusively for telephone business done to or from points without the state, and not including any poles, wires and apparatus used exclusively for telephone business done for the government of the United States, its officers or agent, if any), be and all of them are hereby declared to be an obstruction and a public nuisance on all the streets of said city; and

"Further resolved, that the street superintendent of said city be and he is hereby instructed to forbid and prevent any future installation, or extension of said telephone poles, wires and apparatus; and

"Further resolved, that unless said company obtains such a franchise from said city within thirty (30) days from date hereof, that the street superintendent of said city be and he is hereby further instructed to remove all said telephone poles, wires and apparatus from the streets of said city.

"The passage of this resolution is to be deemed a further notice to said company, and to give it an opportunity and thirty days more time in which to remove its said telephone poles, wires and apparatus from the streets of said city.

"The city clerk shall certify to the passage of this resolution and shall cause a certified copy of the same to be served upon said Sunset Telephone-Telegraph Company at its office in Pomona, California."

And on the 11th day of August, 1905, a notice was served upon complainant, of which the following is a copy:

"To Sunset Telephone & Telegraph Company, a Corporation:

"In accordance with the instructions of the board of trustees of the city of Pomona, contained in its resolutions to the Sunset Telephone & Telegraph Company, made and dated respectively June 6, 1905, and August 1, 1905, and the laws in such cases made and provided, prescribing the powers and duties of street superintendent, the following notice is hereby given said Sunset Telephone & Telegraph Company:

"Under said resolutions and by virtue of the powers and duties of the office of street superintendent of said city, you are hereby notified that in accordance with the facts and conclusions stated in said resolutions, which are hereby made the facts and conclusions of the undersigned street superintendent, all the poles, wires and apparatus of said company employed in doing a state and local telephone business within the city of Pomona are hereby declared a public nuisance and obstruction upon all the streets of said city and hereby ordered to be removed from all the streets of said city within thirty days from August 1, 1905, or I shall immediately proceed to remove the same.

"You are expressly and particularly notified that I will remove only the poles, wires and apparatus of said company doing a state and local telephone business within said city, and that I will not remove or in any manner interfere with, but as to such removal, will 'except telegraph or telephone lines

doing an interstate business,' if any, and will also except from the order of removal all the poles, wires and apparatus of said company doing said 'interstate business,' if any.

"In event you do not voluntarily remove said poles, wires and apparatus doing said state and local telephone business, within said period of thirty days from August 1, 1905, then you are hereby solicited now and before said period of thirty days expires to co-operate with me and assist in the designation of the poles, wires and apparatus of said company doing said state and local telephone business, and in all other matters and things whatsoever, so that there will be no mistake and as little inconvenience as possible to said company and the public; also I desire at same time the designation by you of a place in which to put said poles, wires and apparatus.

"The words 'telephone' and 'telegraph' are not used synonymously, but according to their popular meaning and distinction. S. C. Slemker,

"Street Superintendent of the City of Pomona.

"Dated August 10, 1905."

On the 1st day of September, 1905, two of the respondents, S. C. Slemker and R. G. Loucks, began the removal of the complainant's telephone lines in said city, and continued to prosecute the same until the 5th day of September, 1905, when they were restrained from further interference with said lines by a restraining order issued in this case.

Pillsbury, Madison & Sutro, Gibson, Trask, Dunn & Crutcher, and W. Rodman, for complainant.

Robert G. Loucks, for defendants.

J. P. Wood, amicus curiæ.

WELLBORN, District Judge. This bill was filed to enjoin respondents from removing or interfering with any of complainant's poles and wires in the streets of the city of Pomona, and asserts a right of occupancy for said poles and wires in said streets, upon the following grounds, to wit: First, the act of Congress entitled "An act to aid in the construction of telegraph lines and to secure to the government the use of the same for postal, military, and other purposes," approved July 24, 1866 (14 Stat. 221, c. 230); second, section 536 of the Civil Code of California; third, an alleged contract to that effect between complainant and the city. In addition to the foregoing grounds, complainant contends that under section 1 of the "Broughton Act" (St. Cal. 1905, p. 777, c. 578) it is not required to obtain a franchise from the city. In view of the importance of the questions involved and the elaborate briefs filed, I should be glad, if circumstances allowed, to review fully and in detail the arguments of the respective parties. This, however, is impracticable, on account of other pressing engagements, and I shall therefore simply announce my conclusions in general terms, with occasional specific references to the testimony and authorities.

1. Complainant, as a telephone company, is not within the act of Congress heretofore mentioned, nor is it entitled, because of its telegraph business, if it does such business at Pomona, to claim the benefits of said act as to the poles and wires used in its telephone business. Both these conclusions find abundant support, one expressly and the other by necessary implication, in *Richmond v. Southern Bell Telephone Co.*, 174 U. S. 761, 19 Sup. Ct. 778, 43 L. Ed. 1162, where the court, quoting the syllabus, held that:

"The provisions in the act of July 24, 1866, entitled 'An act to aid in the construction of telegraph lines and to secure to the government the use of the same for postal, military and other purposes,' and Rev. St. §§ 5263 to 5268 (U. S. Comp. St. 1901, pp. 3579-3581), in which those provisions are preserved, have no application to telephone companies, whose business is that of electrically transmitting articulate speech between different points."

In that case complainant alleged in its bill:

"That its 'telephone' wires and poles were used by its subscribers in connection with the Western Union Telegraph Company, under an agreement between the plaintiff and that company for the joint use of the poles and fixtures of both companies in sending and receiving messages; that its business was in part interstate commerce, by reason of its connections with the above telegraph company; and that its status was that of a telegraph company under the laws of the United States, and of the state of Virginia, and of other states of the United States, and that it was and is in fact chartered as a telegraph company under the general laws of New York."

In the Circuit Court a final decree was entered as follows:

"The court, without passing on the rights claimed by the complainant company under the laws of Virginia and the ordinances of the city of Richmond, is of opinion, and doth adjudge, order, and decree, that the complainant company has, in accordance with the terms and provisions and under the protection of the act of Congress of the United States approved July 24, 1866 (which is an authority paramount and superior to any state law or city ordinance in conflict therewith), the right 'to construct, maintain and operate its lines over and along' the streets and alleys of the city of Richmond, both those now occupied by the complainant company and those not now so occupied, and to put up, renew, replace, and repair its lines, poles, and wires over and along said streets and alleys, and the said city of Richmond, its agents, officers, and all others, are enjoined and restrained from cutting, removing, or in any way injuring said lines, poles, and wires of the complainant company, and from preventing or interfering with the exercise of the aforesaid rights by the complainant company, and also from taking proceedings to inflict and enforce fines and penalties on said company for exercising its said rights.
* * *

In the Circuit Court the following action was also had:

"The city asked that the decree be modified by inserting therein, after the words 'construct and operate the same,' the following words: 'So far as to receive from and deliver to the Western Union Telegraph Company messages sent from beyond the limits of the state of Virginia, or to be sent beyond said limits'—and by inserting therein, after the words 'interfering with the exercise of the aforesaid rights by the complainant company,' the following words: 'So far as the reception from and delivery to the Western Union Telegraph Company of any message sent from beyond the limits of the state of Virginia, or to be sent beyond said limits.' But counsel for complainant objected, and the court (using the language of its order) 'intending by said injunction to enjoin the city from interfering with the local business and messages, as well as those of an interstate character,' refused to so modify the decree."

I present these extracts from the bill and the decree and minutes of court in order to show the relation which the complainant there bore to the Western Union Telegraph Company and the kind of services it rendered by virtue of such connection, because, from these facts, it is obvious that the decision of the Supreme Court impliedly, but necessarily, holds that an association between a telephone company and a telegraph company, whereby the telephone company receives

from and delivers to the telegraph company messages sent from beyond the limits of the state or to be sent beyond said limits, does not bring the telephone company within the purview of said act. Now if such an association of two companies is ineffectual to bring the telephone company under said act of Congress, it would seem to follow that said companies would be powerless to accomplish, through indirection and evasion, the same end, by merging themselves into one corporation and causing it to assume the attributes and employments of the two, or, to express the matter differently, that a single corporation, although organized for and engaged in both telegraph and telephone business, as above outlined, cannot, because of its telegraph business, claim the benefits of said act of Congress as to the lines used in its telephone business; and this, in substance, has been unequivocally held by the Circuit Court of Appeals for the Sixth Circuit in *Toledo v. Western Union Telegraph Co.*, 107 Fed. 10, 46 C. C. A. 111, 52 L. R. A. 730.

Multiplication of authorities on this point is unnecessary, but it may not be out of place to add that the principles enunciated in the two cases already cited are further illustrated and applied in *New York ex rel. Penn. R. R. Co. v. Knight*, 192 U. S. 21, 24 Sup. Ct. 202, 48 L. Ed. 325, and *Allen v. Pullman Co.*, 191 U. S. 171, 24 Sup. Ct. 39, 48 L. Ed. 134, and from these principles it results that complainant's telephone lines and telegraph lines are separable, and must be considered as distinct from each other. See, also, *State v. Western U. Tel. Co.*, 75 Kan. 609, 90 Pac. 299. This situation is aptly described in the brief, at pages 41 and 42, filed by amicus curiæ, as follows:

"The local lines are no intrinsic part of any telegraph lines. The telegraph instrument or instruments are situated at the central station of the telephone company, and telegraph messages per se, interstate or intrastate, if transmitted at all, are received at that station. The telegraph transmission then ceases. The mere fact that the messages may be telephoned to subscribers, or other persons in the city, or that persons may send messages to the company's office for telegraphic transmission by telephoning them to such office, does not make the telephone system to subscribers a part of the telegraph system. Only the main toll line extending from the central station to points outside the city can by any construction be regarded as a telegraph line. It is the only line engaged in telegraph business. The local telephone lines are no more a part of the telegraph lines than the United States mail would be if the telegram were received at the central office and mailed to the receiver. They are no more a part of interstate commerce, or of any telegraph system, or of the telegraphic transmission, than the messenger boy who bears the telegraph message to the consignee would be, or a telephone system not owned by the company, but used to communicate the message, would be."

While there is no dispute but that the city of Pomona removed from its streets some of complainant's poles and wires, yet I think, from all the evidence in the case, that the only poles and wires which said city removed, and certainly all it threatened to remove, as shown by the resolution of its board of trustees of August 1, 1905, and the street superintendent's notice pursuant thereto (Exhibits 3 and 4 to complainant's bill), are those which complainant used in its local and intrastate business, and these, as I have already indicated, are not protected by said act of Congress.

Furthermore, while complainant has a telegraph instrument, installed not earlier than 1902, at its central station in Pomona, yet the number of telegraph messages transmitted over its lines to and from Pomona is so inconsiderable as of itself to raise the question whether or not complainant may be fairly said, from a commercial standpoint, to be engaged in a telegraph business at that point. It is true complainant's affidavits show that over all its long-distance lines in California, Oregon, Washington, and Nevada more than 6,000 messages are transmitted each month, and that 16 per cent. of these messages are by telegraph; but they are absolutely silent as to what proportion of said 16 per cent. of telegraph messages reach Pomona. In this connection it is especially important to bear in mind that the burden is on the complainant to establish the telegraph and interstate character of its business (*Penn. R. R. Co. v. Knight*, 192 U. S. 21, 27, 24 Sup. Ct. 202, 48 L. Ed. 325), as well as every other ground essential to the equitable relief it seeks, and its failure, while giving with precision other figures showing the interstate and telegraph business over all its lines, to indicate how much of said business was done at Pomona, when the point is vital to its case, and the facts exclusively within its knowledge and easily accessible, is, under elementary rules of evidence, a strong, if not controlling, circumstance against the claim that its business at said place is, from a commercial point of view, interstate and telegraphic. In this condition of the evidence, general statements, such as some of the affidavits contain, to the effect that complainant does an interstate and telegraph business there, without giving the particulars which the exigencies of complainant's case obviously require, are not only inconclusive, but entitled to but little weight. I am satisfied, from all the information which the record furnishes, that the number of telegraph messages received at and sent from Pomona over complainant's lines are extremely few, while unquestionably the great bulk of its business there is telephone business, and that there is some ground for respondents' contention that such interstate messages as have been transmitted were not in the course of commerce, but to establish the possibility of interstate transmission. To hold, under these circumstances, that complainant's telephone lines to Pomona, because of their potential agency in the receipt and delivery of telegraph messages between the central station of complainant and its subscribers, are an integral part of a telegraph system, and therefore may be rightfully maintained in the streets of said city without its consent under said act of Congress, would, it seems to me, be a manifest perversion of the statute, and directly in the teeth of the decision of the Supreme Court in *Richmond v. Southern Bell Telephone Co.*, supra, and the decision of the Circuit Court of Appeals in *Toledo v. Western U. Tel. Co.*, supra. While the interstate clause of the federal Constitution should always be reasonably construed so as to promote the beneficent purposes for which it was ordained, it should never be employed as an instrumentality to take from a state its legitimate control over local business.

There is yet another view of said act of Congress fatal to complainant's contention on this branch of the case. Said act does not grant

to telegraph companies the right to enter upon private property without the consent of the owner, nor the right of eminent domain. *Western U. Tel. Co. v. Pennsylvania R. R. Co.*, 195 U. S. 540, 25 Sup. Ct. 133, 49 L. Ed. 312; *Western U. Tel. Co. v. Pennsylvania R. R. Co.*, 195 U. S. 594, 25 Sup. Ct. 150, 49 L. Ed. 332. Nor does it confer upon them the right to occupy with their poles, wires, and other fixtures the streets of a city, without the latter's consent. *St. Louis v. Western U. Tel. Co.*, 148 U. S. 92, 13 Sup. Ct. 485, 37 L. Ed. 380; *St. Louis v. Western U. Tel. Co.*, 149 U. S. 465, 13 Sup. Ct. 990, 37 L. Ed. 810; *Postal Telegraph & C. Co. v. Baltimore*, 156 U. S. 210, 15 Sup. Ct. 356, 39 L. Ed. 399; *Richmond v. Southern Bell Tel. Co.*, supra; *Toledo v. Western U. Tel. Co.*, supra; *Cumberland Tel. & Tel. Co. v. Evansville (C. C.)* 127 Fed. 187.

The conclusion of the court in *Western U. Tel. Co. v. Penn. R. R. Co.*, 195 U. S. 540, 573, 574, 25 Sup. Ct. 133, 142, 49 L. Ed. 312, is summarized thus:

"It follows from these views that the act of 1866 does not grant the right to telegraph companies to enter upon and occupy the rights of way of railroad companies except with the consent of the latter, or grant the power of eminent domain."

In *St. Louis v. Western U. Tel. Co.*, 148 U. S. 92, 100, 13 Sup. Ct. 485, 488, 37 L. Ed. 380, the court, in unequivocal terms, applies the same rule to public highways, as follows (underscoring mine):

"It is a misconception, however, to suppose that the franchise or privilege granted by the act of 1866 carries with it the unrestricted right to appropriate the public property of a state. It is, like any other franchise, to be exercised in subordination to public as to private rights. While a grant from one government may supersede and abridge franchises and rights held at the will of its grantor, it cannot abridge any property rights of a public character created by the authority of another sovereignty. *No one would suppose that a franchise from the federal government to a corporation, state or national, to construct interstate roads or lines of travel, transportation, or communication, would authorize it to enter upon the private property of an individual and appropriate it without compensation. No matter how broad and comprehensive might be the terms in which the franchise was granted, it would be confessedly subordinate to the right of the individual not to be deprived of his property without just compensation. And the principle is the same when, under the grant of a franchise from the national government, a corporation assumes to enter upon property of a public nature belonging to the state.* It would not be claimed, for instance, that under a franchise from Congress to construct and operate an interstate railroad the grantee thereof could enter upon the statehouse grounds of the state and construct its depot there, without paying the value of the property thus appropriated. Although the statehouse grounds be property devoted to public uses, it is property devoted to the public uses of the state, and property whose ownership and control are in the state, and it is not within the competency of the national government to dispossess the state of such control and use, or appropriate the same to its own benefit, or the benefit of any of its corporations or grantees, without suitable compensation to the state. This rule extends to streets and highways. They are the public property of the state. While for the purposes of travel and common use they are open to the citizens of every state alike, and no state can by its legislation deprive the citizens of another state of such common use, yet when an appropriation of any part of this public property to an exclusive use is sought, whether by a citizen or corporation of the same or another state, or a corporation of the national government, it is within the competency of the state, representing the sovereignty of that local public, to exact for its benefit compensation for this exclusive appropriation. It matters not for

what that exclusive appropriation is taken, whether for steam railroads or street railroads, telegraphs or telephones, the state may, if it chooses, exact from the party or corporation given such exclusive use pecuniary compensation to the general public for being deprived of the common use of the portion thus appropriated."

City of Toledo v. Western U. T. Co., 107 Fed. 10, 46 C. C. A. 111, 52 L. R. A. 730, holds (quoting from the syllabus) :

"That an interstate telegraph company, which had accepted the provisions of the act of 1866, was not entitled to erect and maintain its lines over the streets of a city without complying with the reasonable regulations of the city for the erection and maintenance of said lines and without procuring a permit therefor from the city."

Cumberland Tel. & Tel. Co. v. City of Evansville (C. C.) 127 Fed. 186, is also a case strongly in point.

In opposition to the views I have above expressed, complainant cited, in its brief filed April 13, 1906, three cases, and at the oral argument another one, which I will briefly notice in detail.

City of Wichita v. Old Colony Trust Co., 132 Fed. 641, 649, 66 C. C. A. 19, is scarcely entitled to be considered a precedent on this point. The act of Congress of July 24, 1866, was not involved in that case, and the expression of the court, with reference to telegraph companies, that "their 'right of way' there has not been dependent on municipal consent," is obiter dictum.

The views, or rather doubts, expressed by Judge Wallace in Western U. Tel. Co. v. New York (C. C.) 38 Fed. 552, 560, 3 L. R. A. 449, in regard to the threatened removal of complainant's wires from the structures of the elevated railway company, do antagonize the conclusion which I have announced above; but these antagonistic views, or doubts, of Judge Wallace must of necessity yield to the decisions of the Supreme Court in the cases above cited.

San Francisco v. Western U. Tel. Co., 96 Cal. 151. 31 Pac. 10, 17 L. R. A. 301, simply determines that, under the facts of that case, a tax upon its franchise in addition to the taxes which complainant pays upon its property in common with others, was beyond the power of the state, and said case has but little bearing upon the point now under consideration.

In Western U. Tel. Co. v. Visalia, 149 Cal. 744, 87 Pac. 1023, the court does say that the plaintiff, by accepting the terms of the act of July 24, 1866, acquired a franchise for its telegraph lines in the streets of Visalia, and that the plaintiff possessed the same franchise, not only by virtue of said act of Congress, but also under section 536 of the Civil Code of California. These, however, seem to have been casual assumptions, and not essential to the decision. Furthermore, if said points had been directly involved, the case, notwithstanding the deservedly high character of the bench by which it was decided, would have to yield, as a precedent, to the decisions of the Supreme Court of the United States above cited.

The comments which I have made upon the last case, apply to St. Louis v. Western U. Tel. Co. (C. C.) 63 Fed. 68, also cited to this point in complainant's last brief (page 44), so far as concerns the statement of the court that the telegraph company, as a govern-

mental agency, under paramount authority of a federal Congress, had the right to use the streets of the city without the city's consent.

Complainant, in its last brief, at page 51, also cites in this connection *Western Union Telegraph Co. v. Commonwealth of Massachusetts*, 125 U. S. 530, 8 Sup. Ct. 961, 31 L. Ed. 790. This case only holds that the complainant is exempt, under the act of July 24, 1866, from taxes which the state of Massachusetts assessed against it, and certainly is no authority for the contention that under said act a telegraph company may occupy the streets of a city without the city's consent, in the absence of any statute of the state giving it the right to do so.

On the next question to be determined, which is largely one of fact, my conclusion is that the city of Pomona has never consented to the perpetual occupancy of its streets by complainant's lines. Certainly as far back as 1901 there is clear evidence of opposition on the part of the city to such occupancy without the procurement by complainant of a new franchise, and from the affidavit of E. E. Armour it appears that in 1899, after the expiration of the franchise granted by Ordinance No. 30, complainant was notified by the board of trustees that its franchise under said ordinance had expired and that it had no franchise, privileges, or other legal rights in said city. The expenditure of \$10,000 by complainant between 1898 and 1902 for the extension and improvement of its system in Pomona, and other expenditures made in the face of the notice above mentioned, certainly are no evidence of any contract between the parties or consent on the part of the city that complainant should for all time or indefinitely maintain its lines in the streets of said city.

There is much conflict in the evidence as to the matters which led up to the passage of the resolutions of October 23, 1903, authorizing the street superintendent to grant permits for the extension of complainant's lines, and of February 4, 1904, directing the removal of complainant's poles and wires from Second street, as well as the subsequent occurrences connected with said resolutions. In the minutes of the board of trustees of May 5, 1903, occurs the following:

"The request of Mr. Keyser, representing the Sunset Telephone Company, that the company be allowed to extend the lines of the company in the city to reach applicants for phone service pending the action of the courts on the question of the rights of the company to operate in this state without franchise was on motion taken under advisement."

This resolution, although Mr. Keyser's application was subsequently, on May 12, 1903, withdrawn by Mr. Pillsbury, lends support to the affidavit of W. H. Posten, and also other affidavits submitted by respondent, that the resolution of October 23, 1903, authorizing the street superintendent to grant permits to complainant for extensions of its lines, was but a temporary provision to save complainant's business from injury during the period which the board of trustees supposed would elapse before there could be had a judicial settlement of the controversy between the parties as to complainant's right to maintain its lines in the streets of said city.

The evidence, however, fails wholly to satisfy me that the board of trustees of said city, by either or both of said resolutions, together

with their related matters and occurrences, entered into any contract with, or gave any consent for, complainant unconditionally and for all time to maintain and operate its telephone lines in the streets of said city. On the contrary, I believe that said city, since the expiration of the franchise granted by Ordinance No. 30, has persistently sought to have complainant procure a new franchise, and never agreed or consented otherwise to occupancy of its streets by any of complainant's lines.

2. Does section 536, Civil Code of California, confer upon complainant the rights which it claims in the streets of Pomona? I am of opinion, that the term "highway," in said section, includes "street." Pol. Code Cal. § 2618; *Abbott v. Duluth* (C. C.) 104 Fed. 833, 836, 837.

Respondents contend, among other things, that said section is in conflict with certain provisions of the California Constitutions of 1849 and 1879, and that it is rendered ineffectual by certain other provisions of the Constitution of 1879; that it is not the grant of a franchise, but constitutes simply a license; and, further, that it does not preclude municipal corporations from fixing the time and conditions upon which their streets may be occupied, and, as one of such conditions, exacting compensation for the parts of the streets exclusively appropriated. In the view which I take of the case, it is unnecessary for me to pass upon either of said contentions, and I shall, therefore, forbear any discussion of them, and assume, without, however, so deciding, that they are unmeritable.

Said section did not, as originally passed March 21, 1872, nor until re-enacted March 20, 1905, include telephone companies. *Richmond v. Southern Bell Telephone Company*, 174 U. S. 761, 19 Sup. Ct. 778, 43 L. Ed. 1162. Of course, I am not unmindful of *Davis v. Pacific Tel. & Tel. Co.*, 127 Cal. 313, 57 Pac. 767, 59 Pac. 698, nor of the rule of the United States courts that they are bound by the construction given to a state Constitution or statute by the highest court of the state. In support of this rule complainant, at pages 78 and 79 of its last brief, filed May 19, 1908, groups quite a large number of cases, and in a note to *Burgess v. Seligman*, 107 U. S. 20, 34, 2 Sup. Ct. 10, 27 L. Ed. 359, there is a list of nearly 50 cases bearing upon the subject. It is unnecessary, however, to review them in detail here, since there is no controversy as to the general rule. To said rule, however, as I have stated it, there are several exceptions, one of them being that, where a federal question is involved, the construction of the state court is not conclusive. This exception is a part of the statement of the rule in the first case cited by complainant, *Fairfield v. County of Gallatin*, 100 U. S. 47, 25 L. Ed. 544; the first paragraph of the syllabus being as follows:

"Where no federal question is involved, this court will follow the construction which has been uniformly given to the Constitution or the laws of the state by its highest court."

The exception is also embodied in the rule as stated in the next case cited by complainant, *Walker v. State Harbor Commissioners*, 84 U. S. 648, 651, 21 L. Ed. 744; the court saying:

"In the construction of the statutes of a state, and especially those affecting titles to real property, where no federal question arises, this court follows the adjudications of the highest court of the state."

There are also limitations, as well as exceptions, to the rule as I have broadly phrased it; but both the exceptions and limitations, or some of them, are often omitted in cases where the rule is applied, for the reason that the facts of the cases do not raise or suggest them. Fed. St. Annot. vol. 4, p. 524, however, formulates the rule, embodying its exceptions and limitations, with sufficient accuracy and fullness for all practical purposes, as follows:

"The construction by the highest judicial tribunal of a state of its Constitution or statutes, which establishes a rule of property, is controlling authority in the courts of the United States, where no question of right under the Constitution and laws of the nation and no question of general or commercial law is involved."

Under the rule thus stated, *Davis v. Pacific Tel. & Tel. Co.*, supra, is not controlling authority in the federal courts, for at least four reasons:

First. The word "telegraph" is so often employed throughout the country in legislative enactments and judicial decisions that its definition would seem to be a matter of general, rather than local, law.

Second. The *Davis Case* does not establish a rule of property, but only determines a question of criminal liability.

Third. Said case is not a construction of section 536 of the California Civil Code, but simply a definition of the word "telegraph" in section 591 of the Penal Code of the state. In that case, the court, after giving to the word "telegraph" a wider scope than consistent with its etymology, says:

"But is this construction justifiable in the case of the penal statute? Section 4 of our Penal Code provides that 'the rule of the common law that penal statutes are to be strictly construed has no application to this Code. All its provisions are to be construed according to the fair import of their terms, with a view to effect its object and to promote justice.' In contemplation of this section, in recognition of the fact that a substantial identity exists between the two words, we think no hesitation need be expressed in declaring that under section 591 of the Penal Code a criminal prosecution will lie for the illegal destruction of a telephone wire."

Thus it appears that the conclusion of the court was reached only by disregarding the common-law rule of strict construction, which section 4 of the Penal Code requires to be done; whereas section 536 of the Civil Code, being a grant from the state, upon its acceptance by the corporation, should be strictly construed. The *Davis Case*, therefore, is not a construction of section 536. On the contrary, the inference is a fair one, from the very language of the court, that, if it had been passing upon said section, under a strict rule of construction, a more limited meaning would have been given to the word "telegraph," and telephone companies would have been excluded from the operation of the section.

Recurring to *Richmond v. Southern Bell Telephone Co.*, supra, it is to be observed that the Supreme Court of the United States was there construing an act of Congress substantially similar to section 536

of the California Civil Code, both of them granting privileges to telegraph companies in public roads and highways.

Fourth. The case at bar involves a federal question, which can be aptly stated in complainant's own language, by quoting from its brief filed April 13, 1906 (pages 99 and 100), as follows:

"Upon its incorporation in 1899 the complainant therefore obtained the benefits of the provisions of section 536 of the Civil Code. By its acceptance of the same, and by the construction, maintenance, and operation of its telephone and telegraph lines throughout the state of California, including Pomona, a contract was created between the state of California and the complainant. This contract became inviolate and could not be impaired by any subsequent legislation."

After referring to the franchise acts, the brief continues as follows, on page 100:

"None of the foregoing acts, however, even if applicable to the complainant, could under the clearest prohibitions of the state and federal Constitutions, affect it or impair the contract, which had been created between it and the state, by its acceptance of the provisions of section 536 of the Civil Code and the construction, maintenance, and operation of its lines in the state of California, including the city of Pomona. These acts could, we submit, be given only a prospective construction, and they could, in any event, be applicable only to new enterprises, undertaken after their passage. Any other construction would be in the teeth of those prohibitions of the federal and state Constitutions, which forbid the impairment of contracts, and which declare that no person shall be deprived of property without due process of law."

The federal question is also expressly alleged in paragraph 11 of the bill as follows:

"And that this case is a suit arising under the Constitution of the United States, to wit, under subdivision 1 of section 10 of article 1 of said Constitution, and under section 1 of article 14 of the amendments to said Constitution. * * *"

There is a long and unbroken line of decisions by the Supreme Court of the United States, expressly holding that the rule as to the conclusiveness of the construction placed upon a state statute by the highest authority of the state does not apply where a federal question, like the one in the case at bar, is involved. *Ohio Life Ins. & Tr. Co. v. Debolt*, 57 U. S. 416, 432, 433, 14 L. Ed. 997; *Jefferson Branch Bank v. Skelley*, 66 U. S. 436, 443, 17 L. Ed. 173; *Bridge Proprietors v. Hoboken Co.*, 68 U. S. 116, 145, 17 L. Ed. 571; *L. & N. R. R. Co. v. Palmes*, 109 U. S. 244, 256, 257, 3 Sup. Ct. 193, 27 L. Ed. 922; *Vicksburg, etc., R. R. Co. v. Dennis*, 116 U. S. 667, 6 Sup. Ct. 625, 29 L. Ed. 770; *Shelby County v. Union, etc., Bank*, 161 U. S. 149, 151, 16 Sup. Ct. 558, 40 L. Ed. 650.

In the first of said cases, *Ohio Life Ins. & Tr. Co. v. Debolt*, 57 U. S. 432, 14 L. Ed. 997, the court says:

"It has been contended on behalf of the defendant in error (the Treasurer of the state) that the construction given to these acts of assembly by the state courts ought to be regarded as conclusive. It is said that they are laws of the state, and that this court always follows the construction given by the state courts to their own Constitution and laws. But this rule of interpretation is confined to ordinary acts of legislation, and does not extend to the contracts of the state, although they should be made in the form of a law; for it would be impossible for this court to exercise any appellate power in a case of this kind, unless it was at liberty to interpret for itself the instru-

ment relied on as the contract between the parties. It must necessarily decide whether the words used are words of contract, and what is their true meaning, before it can determine whether the obligation the instrument created has or has not been impaired by the law complained of. And in forming its judgment upon this subject it can make no difference whether the instrument claimed to be a contract is in the form of a law passed by the Legislature or of a covenant or agreement by one of its agents acting under the authority of the state."

In the next of said cases, *Jefferson Branch Bank v. Skelly*, 66 U. S. 443, 17 L. Ed. 173, the same doctrine is enunciated in the following language:

"We answer to this, as this court has repeatedly said, whenever an occasion has been presented for its expression, that its rule of interpretation has invariably been that the constructions given by the courts of the states to state legislation and to state Constitutions have been conclusive upon this court, with a single exception, and that is when it has been called upon to interpret the contracts of states, 'though they have been made in the forms of law,' or by the instrumentality of a state's authorized functionaries, in conformity with state legislation. It has never been denied, nor is it now, that the Supreme Court of the United States has an appellate power to revise the judgment of the Supreme Court of a state, whenever such a court shall adjudge that not to be a contract which has been alleged, in the forms of legal proceedings, by a litigant, to be one, within the meaning of that clause of the Constitution of the United States which inhibits the states from passing any law impairing the obligations of contracts. Of what use would the appellate power be to the litigant who feels himself aggrieved by some particular state legislation, if this court could not decide, independently of all adjudication by the Supreme Court of a state, whether or not the phraseology of the instrument in controversy was expressive of a contract and within the protection of the Constitution of the United States, and that its obligation should be enforced, notwithstanding a contrary conclusion by the Supreme Court of that state? It never was intended, and cannot be sustained by any course of reasoning, that this court should, or could with fidelity to the Constitution of the United States, follow the construction of the Supreme Court of a state in such a matter, when it entertained a different opinion; and in forming its judgment in such a case it makes no difference in the obligation of this court, in reversing the judgment of the Supreme Court of a state upon such a contract, whether it be one claimed to be such under the form of state legislation, or has been made by a covenant or agreement by the agents of a state, by its authority."

In *Vicksburg, etc., Bank v. Dennis*, 116 U. S. 667, 6 Sup. Ct. 626, 29 L. Ed. 770, the court says:

"In determining whether a statute of a state impairs the obligation of a contract, this court doubtless must decide for itself the existence and effect of the original contract (although in the form of a statute), as well as whether its obligation has been impaired. *Louisville & Nashville Railroad v. Palmes*, 109 U. S. 244, 256, 257, 3 Sup. Ct. 193, 27 L. Ed. 922, and cases cited; *Wright v. Nagle*, 101 U. S. 791, 794, 25 L. Ed. 921."

There are other conditions and circumstances where the constructions state courts give to state statutes are not conclusive upon the United States courts; but, without undertaking a classification of these instances, I will simply cite a few cases illustrative of them: *Pease v. Peck*, 18 How. 598, 15 L. Ed. 518; *Dred Scott v. Sanford*, 19 How. 393, 15 L. Ed. 691; *Yick Wo v. Hopkins*, 118 U. S. 356, 6 Sup. Ct. 1064, 30 L. Ed. 220; *Town of Roberts v. Bowes*, 101 U. S. 116, 25 L. Ed. 880; *Talcott v. Pine Grove*, 23 Fed. Cas. 653, No. 13,735; *Levy v. Stewart*, 78 U. S. 244, 20 L. Ed. 86.

Carroll v. Lessee of Carroll, 16 How. 275, 14 L. Ed. 936, holds that the Supreme Court of the United States is not bound by an obiter dictum of a state court, and by analogy it seems to follow that of still less weight with a United States court, in determining the meaning of a word used in a state statute, is the definition placed by the state court upon that word in another statute, where the two statutes are entirely different, enacted for different purposes, and subject to different rules of construction.

The construction which I have placed upon section 536 answers fully the contention of complainant, at page 99 et seq. of its printed brief, filed April 13, 1906, and page 10 of its reply brief filed May 19, 1908, that the construction, maintenance, and operation of its telephone lines was an acceptance of the terms of said section as to said lines, and constituted a contract, inviolable by subsequent legislation, namely, the franchise acts. The cases from Minnesota and other states cited in complainant's brief to this contention were based respectively upon general laws, which, although in some respects similar to section 536 of the California Civil Code, either expressly or by construction of the court applied to telephone companies, and this widely distinguishes all of said cases from the one at bar.

I am inclined to think, that said contention is also met by the Constitution of 1879 (section 1, art. 12), which provides:

"Corporations may be formed under general laws, but shall not be created by special act. All laws now in force in this state concerning corporations, and all laws that may be hereafter passed pursuant to this section, may be altered from time to time or repealed."

And also section 21 of article 1, which provides:

"No special privileges or immunities shall ever be granted which may not be altered, revoked, or repealed by the Legislature; nor shall any citizen, or class of citizens, be granted privileges or immunities which, upon the same terms, shall not be granted to all citizens."

See *Shields v. Ohio*, 95 U. S. 319, 24 L. Ed. 357; *Union Pac. R. Co. v. United States*, 99 U. S. 700, 25 L. Ed. 496; *Spring Valley W. W. v. Schottler*, 110 U. S. 347, 4 Sup. Ct. 48, 28 L. Ed. 173; *Hamilton Gas L. & C. Co. v. Hamilton*, 146 U. S. 258, 13 Sup. Ct. 90, 36 L. Ed. 963; *Stanislaus County v. San Joaquin, K. R. C. & I. Co.*, 192 U. S. 201, 24 Sup. Ct. 241, 48 L. Ed. 406; *San Antonio Traction Co. v. Altgelt*, 200 U. S. 304, 26 Sup. Ct. 261, 50 L. Ed. 491.

A brief review, chronologically arranged, of the franchise acts of California, is necessary to an intelligent understanding of their relations to and effect upon section 536 of the California Civil Code, and a correct determination of what rights, if any, complainant has under said section as it now stands; that is, as re-enacted March 22, 1905 (St. 1905, p. 777, c. 578).

The first franchise act was passed in 1893. St. Cal. 1893, p. 298, c. 214. Its provisions are certainly incompatible with the acquisition of a franchise under section 536 of the Civil Code, and therefore said act must be held to have repealed said section. A somewhat similar repeal will be found in *Northwestern Tel. Exch. Co. v. St. Charles (C. C.)* 154 Fed. 386. The incompatibility between said act and sec-

tion is emphasized by the franchise act of 1897, which contains several additional provisos, among them the following: "That the governing power may reject any and all bids." St. Cal. 1897, p. 135, c. 107. Complainant, in its last brief, filed May 19, 1908, at page 10, says, referring to the franchise act of 1893: "It excepted all telegraph lines." This statement is wrong, inadvertently made, of course, and I now correct it, merely because of its bearing upon the ruling which I have just made as to the repeal of section 536. If the exception "all telegraph lines" had been made in the franchise act of 1893, then, of course, no repeal, nor even modification, of section 536, could have been thereby effected, because the exception would have been as broad as the section. The franchise act of 1893, however, contains no exception whatever. Complainant has confused the franchise act of 1893 with that of 1897, for there is an exception in the latter act, as follows:

"Except steam railroads, telegraph lines and renewal of franchises for piers, chutes and wharves."

The franchise act of March 11, 1901, differs in this respect from that of 1897, and is as follows:

"Except telegraph or telephone lines doing an interstate business and renewals of franchises for piers, chutes or wharves." St. Cal. 1901, p. 265, c. 103.

The franchise act of March 6, 1903 (St. 1903, pp. 90, 91, c. 82), simply amends certain sections, to wit, 2, 5, and 7, but leaves unchanged section 1 of the act of March 11, 1901 (St. 1901, p. 265, c. 103). Section 536, Civ. Code, as re-enacted March 20, 1905 (St. Cal. 1905, pp. 491, 492, c. 385), includes telephone companies, and its re-enactment, because of the incompatibility above mentioned, doubtless repealed the first section of the then existing franchise act, which was the act of 1901, as amended by the act of 1903, so far as concerns telegraph and telephone lines. The franchise act, however, of March 22, 1905 (St. Cal. 1905, p. 777, c. 578), passed just two days subsequent to the re-enactment of section 536, in turn and for the same reason repealed section 536, except as to telegraph and telephone lines doing an interstate business; in other words, repealed the section so far as concerns telegraph and telephone lines doing a local or intrastate business. So that said section, as it now stands, does not grant to a telephone company any right to maintain in a street poles and wires used in local or intrastate business, and, as I have already shown, these are the only lines with which the city of Pomona threatens to interfere.

On this branch of the case *Abbott v. Duluth* (C. C.) 104 Fed. 833, *Northwestern Tel. Exch. Co. v. Minneapolis*, 81 Minn. 140, 83 N. W. 527, 86 N. W. 69, 53 L. R. A. 175, and *Duluth v. Duluth Telephone Co.*, 84 Minn. 486, 87 N. W. 1127, are without weight as precedents, because, in Minnesota, Gen. Laws 1860, p. 106, c. 12, § 1, granting to telegraph companies, which the court held included telephone companies, the right to erect poles and wires along the public roads and highways, was not limited to companies doing an interstate business, as is section 536 of the California Civil Code by the Broughton or franchise act of 1905 (St. 1905, p. 777, c. 578); *City of Wichita v.*

Old Colony Trust Co., 132 Fed. 641, 66 C. C. A. 19, and Wichita v. Missouri & Kansas Telephone Co., 70 Kan. 441, 78 Pac. 886, 890, are likewise inapplicable here, because the general statute of the state of Kansas (Gen. St. 1868, c. 23, § 74), which conferred upon telegraph companies authority to maintain poles, wires, and other fixtures along the public roads, was without any such limitation to interstate commerce as the Broughton or franchise act of 1905 imposes upon section 536 of the California Civil Code.

The distinction which I have drawn between the case at bar and the Minnesota and Kansas cases, above mentioned, applies equally, with suitable changes of phraseology, to the Iowa, Wisconsin, and Michigan cases cited in complainant's brief. Indeed, I have not found a case outside of California where the general law of the state authorizing telegraph and telephone companies to construct their lines along the public roads and highways was restricted to companies doing an interstate business, as is section 536 of the California Civil Code by the franchise act of 1905.

3. The evidence fails to establish, as I have already shown, any contract between complainant and the city of Pomona, other than by Ordinance No. 30, for the occupancy of the latter's streets with telephone lines of complainant. Village of London Mills et al. v. White et al., 208 Ill. 289, 70 N. E. 313, and the other cases in line therewith, cited under this head at page 16 of complainant's last brief, are so widely different as to material facts from the case at bar that it is unnecessary to examine them in detail. In each of said cases, with one exception, the implied contract, which the court held binding, grew out of the acceptance of an ordinance or resolution passed under statutory authority and expressly granting the franchise claimed. In the case which I have excepted from this general statement, namely, City of Bradford v. N. Y. & P. Tel. & Tel. Co., 206 Pa. 582, 56 Atl. 41, the suit was brought by the city to compel the removal from its streets of defendant's poles and wires, which had occupied the streets more than 21 years without any objection from the city authorities, and the bill was dismissed for laches.

In the case at bar, as I have already shown, section 536 of the California Civil Code did not apply to telephone companies when complainant's lines were constructed in the city of Pomona, nor was there any ordinance or resolution ever passed by the trustees of said city authorizing such construction, except Ordinance No. 30, which limited to 10 years the privileges it granted, and this period expired in August, 1898. So that the first and most obvious element of an implied contract, such as was found by the court in each of the cases cited by complainant, is wholly lacking in the case at bar.

I have given to the opinion of Judge Beatty, which forms, as an exhibit, part of the bill herein, that careful consideration which the high respectability of its authorship invites, but am unable to adopt its conclusions.

Complainant's contentions, that respondents removed its lines from the streets of Pomona in an irregular and unauthorized way, in that the resolution of August 1, 1905, concerned "Sunset Telephone-Tele-

graph Company," a corporation separate and distinct from complainant, and in that the conditions of said resolution were impracticable, and in that the board of trustees directed the removal by resolution, rather than by ordinance, I think, are not well taken. As complainant is unlawfully maintaining its intrastate and local lines in the streets of Pomona without right and against the city's consent, it will not be heard to say that the removal of such unlawful obstructions was or is otherwise informal. A suitor must come into a court of equity with clean hands, and cannot, in such a forum, protect an unlawful occupancy of streets by asserting that such occupancy is being informally or irregularly disturbed.

The bill will be dismissed, and respondents' solicitor is requested to prepare and submit a suitable form of decree.

UNITED STATES v. MESCALL (four cases).

(Circuit Court, E. D. New York. May 7, 1908.)

Nos. 3-7 (753, 764, 765, 774).

1. CUSTOMS DUTIES (§ 125*)—CRIMINAL LAW—"ENTRY."

In Customs Administrative Act June 10, 1890, c. 407, § 9, 26 Stat. 135 (U. S. Comp. St. 1901, p. 1895), relating to the crime of making or attempting to make entry by means of a fraudulent practice, etc., the word "entry" does not refer alone to the act of filing at the custom house the written paper known as an "entry," but embraces the entire transaction of passing the goods through the custom house, among the various steps of which would be the official returns of customs weighers.

[Ed. Note.—For other cases, see Customs Duties, Dec. Dig. § 125.*]

For other definitions, see Words and Phrases, vol. 3, p. 2408.]

2. CUSTOMS DUTIES (§ 128*)—ILLEGAL ENTRY—"OTHER PERSON."

Under Customs Administrative Act June 10, 1890, c. 407, § 9, 26 Stat. 135 (U. S. Comp. St. 1901, p. 1895), relating to the crime of making an illegal entry by the owner, importer, consignee, agent, "or other person," the term "other person" does not embrace all individuals who may be fraudulently concerned in the making of an entry, and would not include a customs weigher, who had merely made false reports of weights in furtherance of an importer's attempt to make an illegal entry.

[Ed. Note.—For other cases, see Customs Duties, Dec. Dig. § 128.*]

On Demurrer to Indictments for Illegal Entry.

William J. Youngs, U. S. Atty.

Eugene F. O'Connor, Jr. (Leo Oppenheimer, of counsel), for defendant.

CHATFIELD, District Judge. Each of these indictments is brought under section 9, c. 407, Act June 10, 1890, 26 Stat. 135 (U. S. Comp. St. 1901, p. 1895), which forbids the making or attempting to make an entry of imported merchandise by means of any false or fraudulent practice or appliance, false statement, or false paper, etc. Each indictment consists of more than one count, based upon different provisions of the same statute, and all are alike in the fundamental idea

*For other cases see same topic & § NUMBER in Dec. & Am. Digs. 1907 to date, & Rep'r Indexes

that they charge the defendant, who is stated to be a weigher in the customs service of the United States, with having made and having attempted to make entry of certain cheese by means of false statements and papers and practices. The basis of the charge is an accusation that, after the importer had entered his goods in the custom house, the defendant made a false return of the weights to the collector of customs, for the purpose of having the liquidation of the entry made upon the basis of that false weight, and thus causing the amount of duty exacted to be less than that which should be paid upon the correct weight of the importation.

Section 9 of the customs administrative act is a modified re-enactment of certain provisions which have long been embodied in the Revised Statutes. The original provision was contained in Act March 2, 1799, c. 22, § 66, 1 Stat. 677. In 1863, chapter 76, becoming a law upon March 3d of that year (Act March 3, 1863, c. 76, 12 Stat. 737), was enacted and furnished a more or less comprehensive statute with relation to the importation of merchandise and the duties of importers and of officials of the government with relation thereto. Section 1 of this law, in connection with various other provisions, contained substantially the language of the first portion of section 9 of the Act of 1890. Section 3 of that act contained substantially similar provisions to those now embodied in section 5445 of the Revised Statutes (U. S. Comp. St. 1901, p. 3678), and section 4 provisions substantially similar to those of section 5444 of the Revised Statutes (page 3677). Upon the compilation of the Revised Statutes of the United States in 1874 the various provisions of the act of 1863 were carried into the revision; and in 1890 that portion of section 1 of the law of 1863 above referred to was put into a separate section, a paragraph added imposing a criminal penalty upon the person making the false entry, and a phrase inserted in the civil portion of the section requiring the fraud to be one "by means whereof the United States shall be deprived of lawful duties."

An inspection of these various statutes and of the accompanying provisions of the law of 1863 would justify the interpretation that the word "entry," in the act of June 10, 1890, and in the preceding acts, referred to the filing of the written paper called the "entry" with the collector of the port, and that any false statement, document, or appliance used in making or attempting to make the entry must accompany the entry at the time of its filing, or be used as a part of the transaction prior to the receipt of the paper entry by the collector. In fact, the law of 1863, immediately after the words referred to, provides for the performance of certain acts by the collector immediately upon the making of such entry, and that duty shall not be finally liquidated until certain papers have been received, "provided that such liquidation shall not be delayed longer than eighteen months from the time of making such entry." The words "such entry," as has been said, occur frequently throughout the act, and in each place are capable of the above interpretation. Such an interpretation would make it impossible to sustain this indictment, which charges the examiner or weigher with making a false "entry," by furnishing a false statement

of weight for the purpose of liquidation, subsequent to the filing and acceptance by the collector of the paper called the "entry" and the completion of that step in the transaction.

But these provisions, now contained in section 9, have been differently interpreted in this circuit, and while the decision, perhaps, was not necessary to a determination of the particular case, it would seem to be the law of this circuit that the word "entry," in section 9 of the customs administrative act, refers to the entire transaction of passing the goods through the custom house, and hence includes the various steps, among which is the return of a statement of the weights with respect to goods subject to a specific duty upon weight. The question was first considered by Judge Blatchford in the case of *United States v. Baker*, 5 Ben. 251, Fed. Cas. No. 14,500. In charging a jury under almost precisely similar circumstances, Judge Blatchford said:

"The word 'entry' in the first section of the act of 1863 * * * means not only the entry specified in the preceding part of that section, but any entry, so called, in custom house language. * * * There is an entry for warehouse, such as was the original entry in this case. * * * There is a withdrawal entry, as there was in this case. * * * For the purposes of the clause which I have read to you, inflicting this forfeiture, the word 'entry' means the entire transaction by which the importer obtains the entrance of his goods into the body of the merchandise of the United States."

Judge Blatchford goes on to say that "any false practice, or any false appliance, * * *" previous to the liquidation and the payment of duties, may work a forfeiture and be within the provisions now contained in section 9. Judge Blatchford then charged that any bribing of a weigher, with the intent to procure a false return, would come within the provisions of this section.

This seems to be the only positive interpretation of these particular words. In the case of *United States v. Legg*, 105 Fed. 930, 45 C. C. A. 134, the Circuit Court of Appeals for this circuit, referring to the word "entry" in section 2785 of the Revised Statutes (U. S. Comp. St. 1901, p. 1867), said:

"The term 'entry' in the acts of Congress is used in two senses. In many of the acts it refers to the bill of entry—the paper or declaration which the merchant or importer in the first instance hands to the entry clerk. In other statutes it is used to denote, not a document, but a transaction, a series of acts which are necessary to the end to be accomplished, viz., the entering of the goods.' *Hoffman, J.*, in *U. S. v. Cargo of Sugar*, 3 Sawy. 46, Fed. Cas. No. 14,722. That case was a prosecution under a statute providing a penalty 'if any owner or consignee of goods shall knowingly make or attempt to make an entry thereof by means of any false invoice or false certificate, * * * or of any other false or fraudulent practice or appliance whatsoever.' Manifestly, the word 'entry,' in such statute, referred to the entire transaction of passing the goods through the custom house. To the same effect is *U. S. v. Baker*, 5 Ben. 251, Fed. Cas. No. 14,500."

It may be noted that Judge Hoffman, in his charge in the *Sugar Case*, supra, interpreted the word "entry" as covering a series of acts, but did not extend that series of acts beyond the completion of the filing of the paper commonly known as an "entry." But, however this may be, the approval of the Circuit Court of Appeals and the language used by Judge Blatchford make it necessary to hold that the

transaction prohibited by section 9 of the law of 1890 may occur at any time in connection with the entering of goods into the United States through the custom house. Under this interpretation of the section, the act of the defendant in this case would be held to be one upon which forfeiture could be based, upon which the value of the goods, if they could not be forfeited, might be collected from the person making the entry, and upon which a prosecution of that person might be had.

The defendant, however, has demurred to these indictments upon the additional ground that section 9 applies to no person except one who can be considered as within the class of "owners, importers, consignees, agents," etc. It is argued that no "assistant weigher" in the customs service can be brought within this class, without construing the words "other person" to mean "any person whatever." This is an unnecessary attempt at straining the construction of the statute. An assistant weigher, or any individual who came within the scope of the provisions of the section, in the sense of making or attempting to make an entry, would certainly be within the class of "owners, importers, consignees, agents, and other persons" referred to in the statute.

Nor is it necessary to consider the further objection, which is urged, that no actual deprivation of duty to the United States is shown. The decision of this court, in the recent case of *U. S. v. 210 Half Cases of Cheese and 59 Cases of Figs*, 163 Fed. 369, may be assumed to set forth the allegations which would be considered necessary to show a deprivation of duty upon which forfeiture or prosecution could be had. But it is apparent from the allegations of the indictment that the defendant is not in fact any of the persons within the contemplation of section 9, with relation to these particular importations, and cannot be considered either an "owner, importer, consignee, agent, or other person."

The defendant, Mescall, was not making or attempting to make an entry of these goods. According to the charge he was, contrary to his duty, rendering assistance to the importer, who was the "person" making the entry. The statute does not provide for the case of all individuals who may assist or have a fraudulent part in the making of an entry (in either sense of the word) by some other person. In fact, in the recent case of *U. S. v. One Silk Rug* (decided by the Circuit Court of Appeals in the Third Circuit) T. D. 28,779, 158 Fed. 974, section 9 has been held to apply to no one but the person who files the entry with the collector of the port; and, however that decision may be viewed, it is authority for the present proposition. If the statute had in that case been held broad enough to include all persons actually making the entry, either through the filing of the entry by themselves or by some one at their direction, nevertheless a weigher, whose connection with the transaction was merely such as that of the defendant Mescall in this case, would not be one of the parties chargeable, or referred to by the words "such person" in the criminal portion of this statute.

The case of *U. S. v. 1,150½ Pounds of Celluloid*, 82 Fed. 627, 27 C. C. A. 231, while differing in some respects from *U. S. v. One Silk*

Rug, supra, reviews a number of cases with reference to the forfeiture of goods under these sections, and is additional authority for the proposition that the defendant, Mescall, is not included in the scope of the prohibitions of section 9.

The demurrers will be sustained.

UNITED STATES v. MESCALL (three cases).

(Circuit Court, E. D. New York. May 7, 1908.)

Nos. 6-8 (768-770).

1. CUSTOMS DUTIES (§ 128*)—ILLEGAL ENTRY—"ENTRY."

Section 5444, Rev. St. (U. S. Comp. St. 1901, p. 3677), relating to the crime of illegally admitting imported goods to "entry," does not refer merely to the act of filing at the custom house the document known as an "entry," but comprises the transaction of entering the goods into the body of the commerce of the country; that is, the whole process of passing the goods through the custom house, which cannot be deemed complete until liquidation has been had.

[Ed. Note.—For other cases, see Customs Duties, Dec. Dig. § 128.*

For other definitions, see Words and Phrases, vol. 3, p. 2408.]

2. CUSTOMS DUTIES (§ 128*)—ACCESSORIES AFTER THE FACT—"AID IN THE ILLEGAL ADMISSION OF IMPORTS."

Section 5444, Rev. St. (U. S. Comp. St. 1901, p. 3677), relating to "aid in the illegal admission of imports," includes aid given both before and after the fact; and where a customs officer aids one who has made wrongful entry, by concealing the falsity of the entry, or by supporting it by false official returns, he is within the prohibition of the section.

[Ed. Note.—For other cases, see Customs Duties, Dec. Dig. § 128.*]

On Demurrer to Indictments for Aiding in Effecting an Illegal Entry of Imported Merchandise.

William J. Youngs, U. S. Atty.

Eugene F. O'Connor, Jr. (Leo Oppenheimer, of counsel), for defendant.

CHATFIELD, District Judge. Demurrers have been interposed to the three indictments above entitled, which have been brought under the provisions of section 5444, Rev. St. (U. S. Comp. St. 1901, p. 3677), which is as follows:

"Sec. 5444. Every officer of the revenue who, by any means whatever, knowingly admits or aids in admitting to entry any goods, wares, or merchandise, upon payment of less than the amount of duty legally due thereon, shall be removed from office, and shall be fined not more than five thousand dollars, or be imprisoned not more than two years."

These indictments in effect charge that certain goods had been imported into the United States, and entered by the importer with the collector of the port, under an entry number; that these goods were subject to a specific duty, and that the defendant, who was an officer of the customs service, as a part of his official duties, was to weigh the goods included in this particular importation, and to return to the col-

*For other cases see same topic & § NUMBER in Dec. & Am. Digs. 1907 to date, & Rep'r Indexes

lector a true statement of the result of that weighing, from which statement the amount of duty to be collected was to be liquidated and paid; that in fact the defendant returned a false statement of weight, upon which false weight duty was paid (the amount of this payment being too little in proportion to the amount by which the false weight was less than the actual weight); that the defendant by so doing unlawfully admitted or aided in admitting to entry the goods specified, upon payment of less than the amount of duty legally due thereon.

It may be observed at the outset that the use of the words of the statute "admits or aids in admitting," if standing alone, might be objectionable on the ground of duplicity; but inasmuch as the indictments in question set forth specifically the details of the transaction, and inasmuch as it is apparent that but one act is recited and one offense charged in each count, and inasmuch as it further appears from this recital that the offense with which the defendant is charged is that of "aiding in admitting," the word "admit" must be regarded as surplusage. This is apparent, also, from an examination of the acts charged, which shows that the defendant was not the official in the customs service who admitted the goods, in the sense of receiving the entry when filed, nor who released the goods upon payment of duty after final liquidation. The various grounds of demurrer, therefore, may be reduced to the general proposition that the indictment is claimed not to set forth a crime under the statute specified, in that the acts of the defendant occurred subsequent to the filing of the paper known as an "entry" in the customs service; that the process of entering the goods was completed by the filing of that paper and its receipt by the proper officer of the customs service; and that the defendant cannot be accused, under the language of this statute, with having aided in admitting goods to entry, if the entry referred to has been accomplished without that aid. This necessitates determining what the word "entry" in section 5444 comprises.

As has been said in the opinion filed with reference to the indictments against this same defendant under section 9 of the customs administrative act (Act June 10, 1890, c. 407, 26 Stat. 135 [U. S. Comp. St. 1901, p. 1895]), reported in 164 Fed. 580, the various statutes which have been placed among the laws of the United States in the revision of 1874, and which prior to that time were comprised in different sections of Act March 3, 1863, c. 76, might well be deemed to be limited to the paper known as an "entry," and to the process of filing the same, up to the point where that entry is accepted and the papers passed on for liquidation. Both with reference to ad valorem and specific duties, the transactions, either in ascertaining the duty where a specific duty is to be paid, or in proving and liquidating the amounts in the case of ad valorem duties, might have been considered steps in a process subsequent to entry, and subsequent to the transaction referred to as an "entry" in the provisions of section 5444, and thus the word "entry" in that statute have been confined to a series of acts up to the point stated.

But for the purposes of section 9 of the customs administrative act the word "entry" has been construed differently, and in the case of

United States v. Legg, 105 Fed. 933, 45 C. C. A. 134, this use of the word has been approved; also, in the case of United States v. Browne (C. C.) 126 Fed. 766, at page 773, an indictment similar to the one at bar was held good, where the act charged was that of an examiner, subsequent to the filing of a paper called an "entry." Because of the reasons approved by these cases it is difficult to see why the word "entry," in section 5444, unless otherwise determined by the higher courts of this circuit, should not be construed as comprising the transaction of entering the goods into the body of the merchandise in the United States; that is, the whole process of passing the goods through the custom house.

This interpretation, however, is not absolutely necessary. When a statute defines as a crime the act of some person aiding a principal offender, then the person giving this aid is an "accessory," and, if the circumstances render it possible, he may be an accessory either before or after the fact. There is no inherent reason in the language of the statute which would indicate that Congress did not intend to make it possible to punish any individual who, in a transaction based upon a false or fraudulent entry paper, aided the wrongdoer by concealing the falsity, or by rendering other false statements to correspond with the original false entry. If the principal crime be treated as that of admitting goods to entry, in the sense of allowing an entry blank to be filed and the papers sent on for the liquidation of duty, then that crime would be aided by an official who repeated the falsehood concealed in the original entry.

It may be admitted that criminal statutes are to be construed strictly, and that no words can be read into a statute in order to give it a particular meaning. It is evident that section 5444 imposes a penalty for what is called therein admitting goods to entry upon the payment of less than the amount due; whereas the crime just referred to might be more fully described as aiding in defrauding the United States, or aiding in the presentation to the government of a false document with the intent to assist in a fraud. But it is not considered that construing section 5444 to cover the present case is reading anything into the statutes, unless the courts finally determine both that the word "entry" relates merely to the transaction up to the time of filing the paper, and that no person can be an accessory to the entry of goods upon payment of a less amount of duty after the entry blank is filed and accepted. The very words of the statute, "upon the payment of less than the amount of duty legally due," would indicate that, if the statute is to be applied to any case of specific duty, the entry cannot be deemed completed until liquidation has been had.

The demurrers, therefore, will be overruled.

UNITED STATES v. MESCALL (three cases).

(Circuit Court, E. D. New York. May 7, 1908.)

Nos. 9-11 (771-773).

1. CUSTOMS DUTIES (§ 125*)—ILLEGAL ENTRY—"ENTRY."

In section 5445, Rev. St. (U. S. Comp. St. 1901, p. 3678), relating to the illegal "entry" of imports, the term "entry" is not limited to the paper so known in the customs service, nor to the making and filing of it, nor the process of filing it and thereby entering the goods.

[Ed. Note.—For other cases, see Customs Duties, Dec. Dig. § 125.*]

For other definitions, see Words and Phrases, vol. 3, p. 2408.]

2. CUSTOMS DUTIES (§ 125*)—AID SUBSEQUENT TO ENTRY—"EFFECTS."

The expression "effects, or aids in effecting," an illegal entry of imports, in section 5445, Rev. St. (U. S. Comp. St. 1901, p. 3678), includes aid in carrying out the fraud, rendered either after or before entry at the custom house.

[Ed. Note.—For other cases, see Customs Duties, Dec. Dig. § 125.*]

3. CUSTOMS DUTIES (§ 128*)—STATUTES.

Section 5445, Rev. St. (U. S. Comp. St. 1901, p. 3678), relating to "every person" who aids in effecting the illegal entry of imports, while ordinarily not intended to apply to those individuals—customs officers—covered by the preceding section of the law, does not exclude an officer of the service if the facts bring him within the definition of the "person" at whom this provision is aimed, and may therefore include a customs weigher who aids in the way prohibited.

[Ed. Note.—For other cases, see Customs Duties, Dec. Dig. § 128.*]

4. CUSTOMS DUTIES (§ 125*)—FAILURE OF FRAUDULENT ENTRY—LOCUS PŒNITENTIÆ.

The penalty provided for illegally effecting the entry of imports, under section 5445, Rev. St. (U. S. Comp. St. 1901, p. 3678), cannot be avoided on the theory that the fraud would not have been successful until the release of the goods after payment of the duty, and the participants in the wrongdoing might have repented before that time.

[Ed. Note.—For other cases, see Customs Duties, Dec. Dig. § 125.*]

On Demurrers to Indictments for Criminally Aiding in Effecting an Illegal Entry.

William J. Youngs, U. S. Atty.

Eugene F. O'Connor, Jr. (Leo Oppenheimer, of counsel), for defendant.

CHATFIELD, District Judge. These indictments are all brought under section 5445 of the Revised Statutes (U. S. Comp. St. 1901, p. 3678), which is as follows:

"Sec. 5445. Every person who, by any means whatever, knowingly effects, or aids in effecting any entry of any goods, wares, or merchandise at less than the true weight or measure thereof, or upon a false classification thereof as to quality or value, or by the payment of less than the amount of duty legally due thereon, shall be fined not more than five thousand dollars, or be imprisoned not more than two years, or both."

The defendant is charged with having returned false weights to the collector of customs, upon which the liquidation of duties with

*For other cases see same topic & § NUMBER in Dec. & Am. Digs. 1907 to date, & Rep'r Indexes

reference to an importation previously made was to be computed. Upon this the defendant is accused of having knowingly effected and aided in effecting an entry of these goods by the payment of less than the amount of duty legally due. Demurrers have been interposed upon the ground that section 5445 does not apply to a transaction of this sort.

It is claimed that the word "entry" in the section refers to (1) the paper known as an "entry" in the customs service; or to (2) the making and filing of that paper; or to (3) the process of making and filing this paper, and thereby entering the goods. It is argued that anything after this technical entry has been made has to do with liquidation, release, or the payment of duty, and that the section was inserted in the statutes for the purpose of prohibiting frauds with relation to the filing of this particular paper known in the service as an "entry."

This argument has been thoroughly discussed in the preceding opinion with reference to indictments Nos. 768, 769, and 770 (164 Fed. 584). But in addition it may be observed that section 5445 forbids the doing of any act which "aids in effecting any entry." Congress did not use the words "enter or aid in entering," but apparently, for some purpose, adopted the more comprehensive terms "effect or aid in effecting an entry." To "effect" anything is "to accomplish it; to achieve it; to bring it to an issue of full success"—as defined by the Standard Dictionary. To bring a matter to full success, when applied to such a transaction as the one in question, would seem to mean to effectuate or to carry into effect; and certainly a person who aids in so doing might lend his aid either before or after the act itself.

The meaning of these indictments, similarly to those above referred to in the previous opinion, must be limited to the allegation of aiding, so far as this particular transaction is concerned. A person who aided in effecting might be said to have also participated in the effecting itself. But no broader meaning is given thereby, and the one transaction which is charged by these indictments as criminal is that of assisting in carrying out the fraud, and this would seem to be within the scope of the Revised Statutes.

Section 5444 (U. S. Comp. St. 1901, p. 3677) and the various statutes from which it has been derived, relate to an officer of the customs service. Section 5445 comprises every person who commits the offense. While ordinarily intended to apply to those individuals not covered by section 5444, there seems to be no reason for excluding an officer of the service, if the facts alleged bring him within the definition of the "person" at whom section 5445 is aimed. Indictments under each section might be equivalent to two counts, substantially setting forth the same offense, and in case of a conviction but one sentence might be proper or legal; but that is not an objection to be taken by demurrer to each indictment separately.

Again, it is urged that, unless actual fraud or deprivation of duty is alleged, the defendant can insist that a *locus pœnitentiæ* existed for him; that up to the release of the goods after payment of a wrong amount of duty any fraud on the part of the person assisting or aiding

would not be criminal under the statute unless successful. It is only necessary to say that the indictments show, first, that the attempt would be successful, and would result in fraud of the government, if not detected; second, that the indictments show a completion of the fraud to a point beyond a mere attempt on the part of the defendant; and, third, the statute (and this is true of section 5444, as well as section 5445) makes it a crime to aid in any material step of a fraudulent importation, even if that fraud be detected, and loss of duty be prevented by seizure and forfeiture under section 9 of the act of 1890 (Act June 10, 1890, c. 407, 26 Stat. 135 [U. S. Comp. St. 1901, p. 1895]), or in any other manner.

The provisions of section 9, providing for seizure and forfeiture of the entire importation for a fraud in the process of entry, show the manner in which the crime may be consummated, and yet the government be protected from loss, the importation ultimately completed, accomplished not by the fraud, but in spite of the same.

The demurrers will be overruled.

In re RICE.

(District Court, E. D. Pennsylvania. October 16, 1908.)

No. 2,918.

1. BANKRUPTCY (§ 400*)—EXEMPTIONS—EXCEPTION BY TRUSTEE TO ALLOWANCE —“CREDITORS.”

General order in bankruptcy No. 17, authorizing “creditors” to except to the allowance of the bankrupt’s exemption, does not exclude the trustee, who may except on behalf of all of the creditors to such allowance on the ground of the bankrupt’s fraud.

[Ed. Note.—For other cases, see Bankruptcy, Dec. Dig. § 400.*

For other definitions, see Words and Phrases, vol. 2, pp. 1713-1726; vol. 8, pp. 7622-7623.]

2. BANKRUPTCY (§ 399*)—RIGHT TO EXEMPTION—FRAUDULENT CONCEALMENT OF PROPERTY.

Where a bankrupt, who was a retail merchant, is shown to have had and disposed of, or concealed, some \$50,000 worth of merchandise within a year prior to his bankruptcy, but a small part of which is in any way accounted for, he is not entitled to his exemption of \$300 under the Pennsylvania statute, which denies the right of exemption to a debtor who conceals his property with intent to defraud his creditors.

[Ed. Note.—For other cases, see Bankruptcy, Dec. Dig. § 399.*]

In Bankruptcy. On certificate of referee concerning bankrupt’s claim for exemption.

The following is the report of Referee Theodore M. Etting, referred to in the opinion:

“The trustee, after setting apart the bankrupt’s exemption as claimed, filed a petition excepting to its allowance, on the ground that the bankrupt had sold and disposed of his goods, merchandise, and property with intent to defraud his creditors. Within 20 days thereafter the bankrupt filed an answer to the above petition, denying that he had sold and disposed of his goods, merchan-

*For other cases see same topic & § NUMBER in Dec. & Am. Digs. 1907 to date, & Rep’r Indexes

dise, and property, and upon the issue thus raised extended testimony was taken. Upon argument I was asked by counsel for the bankrupt to dismiss the exceptions filed by the trustee on the ground that the trustee is not a creditor and had no right under the general orders or under the act to file exceptions to his own report.

"The word 'creditor,' as defined by the act, 'shall include any one who owns a demand or claim provable in bankruptcy and may include his authorized agent, attorney or proxy.' No adjudicated case serves as a precedent for my guidance.

"Mr. Remington, the most recent text-writer on Bankruptcy Practice, seems, however, to consider that there is no ground to suppose that the meaning of general order No. 17 excludes the trustee. Remington on Bankruptcy, p. 614.

"It is also to be noted that the bankrupt joined issue upon the pleadings as filed. His objection, therefore, is not timely. I therefore refuse to dismiss the exceptions on the ground that they were filed by the trustee, and not by a creditor.

"I find the facts to be as follows:

"An adjudication in bankruptcy was entered against the above-named Joseph Rice on the 20th day of November, 1907, upon petition filed against him on the 16th day of October, 1907. From his own evidence it appears that on December 18, 1906, he made a statement showing that he had assets in excess of liabilities amounting to \$23,700. He further testified to the purchase of merchandise to the extent of \$30,000 within less than six months preceding his bankruptcy. On October 4, 1907, it appears from his testimony that the value of his merchandise then on hand did not exceed \$2,500, and it appears that at the time of his adjudication its value was in the neighborhood of \$1,000. It is therefore apparent that since December, 1906, assets in excess of \$50,000 have disappeared. His schedules show that he still owes merchandise creditors about \$36,000, and it therefore is evident that but an inconsiderable part of the sum realized from the sale of merchandise could have been paid to his merchandise creditors. The bankrupt says he paid his help, and also that he had a drayman who robbed him; but it does not appear from his testimony that any considerable part of the \$50,000 above referred to can be reasonably accounted for in this way. The amount of goods which he attempts to account for as stolen varies from \$2,000 to \$25,000. It is incredible to suppose that the latter figures are correct. It also appears from his testimony that between December 18, 1906, and October, 1907, he lost about 10 per cent. on sales; but, if the utmost credence be given to this statement, it would only account for about \$6,000.

"It also appears that the bankrupt made assignments of his book accounts—some to a relative; others to friends. For these assignments he says he obtained about \$4,000; but he cannot account for a single penny, nor can he state the amount of any check received for such assignments, or when or where the money received was deposited. With reference to his own affairs the bankrupt displays an ignorance which it is difficult to suppose was not assumed. Again and again, when called on for information with respect to matters of which he cannot reasonably be supposed to be ignorant, his reply was, 'I don't remember.'

"Giving to the bankrupt the fullest benefit which could fairly be claimed because of imperfect knowledge of English or bad memory, no one, I think, could have heard his testimony without being impressed with the belief that it was incredible, and that in replying, as he did, that he could not remember, that he was in point of fact committing perjury.

"The only conclusion which I am able to draw from his testimony is that he managed to make away with the goods or their proceeds. The case in many respects is on all fours with that in *Re Leverton*, recently decided in the Middle District (19 Am. Bankr. Rep. 426, 155 Fed. 925), and I can only repeat in conclusion, as was there said, 'that the exemption given by the law was never intended for any such character of debtor.'

"The exemption asked for is therefore denied."

Furth & Singer, for bankrupt.

Clinton O. Mayer and Irwin L. Sessler, for trustee.

J. B. McPHERSON, District Judge. I agree with the learned referee, whose report appears herewith, in his ruling that the trustee may except to the allowance of the statutory exemption on the ground of the bankrupt's fraud. The trustee's duty to "set apart the bankrupt's exemption and report the items and estimated value thereof to the court," etc. (section 47, cl. 11), does not deprive him of the right, or, indeed, relieve him of the obligation, to decide on behalf of the creditors, whose representative he is, whether the bankrupt is entitled to the exemption at all, or has forfeited it by improper conduct. On principle, I see no reason why he may not come to this decision preliminarily, and refuse altogether to set apart the exemption; but as a matter of practice it is no doubt better that the trustee should first perform the purely ministerial function of separating and appraising the property, in accordance with general order 17, so that the specific articles may be designated; and then, if in his opinion he is justified in so doing, that he should make known formally the grounds on which he denies entirely the bankrupt's right to the benefit of the statutory privilege. The provision in the general order, that "any creditor may take exceptions to the determination of the trustee," etc., does not expressly, nor I think by fair implication, exclude the trustee. Certainly any creditor, acting by an agent, could take exception to the determination of the trustee, and the trustee himself, as the representative of the whole body of creditors, and therefore the most suitable person to act in their behalf, is in my opinion clearly within the spirit of the general order. Indeed, as the referee has supposed, he may even be fairly within the statutory definition of the word "creditor," and may thus be expressly authorized to except.

Upon the facts nothing need be added to the report of the referee. I have made a prolonged examination of the testimony, and fully agree with his findings.

The order refusing the bankrupt's exemption is affirmed.

In re STERLINGWORTH RY. SUPPLY CO.

(District Court, E. D. Pennsylvania. November 4, 1908.)

No. 3,135.

BANKRUPTCY (§ 20*)—PROCEEDINGS AGAINST CORPORATION—EFFECT OF STATE RECEIVERSHIP.

A corporation may be adjudged an involuntary bankrupt, where the petition alleges sufficient grounds, notwithstanding the fact that a receiver was appointed for its property by a state court more than four months prior to the filing of the petition, who is still in possession.

[Ed. Note.—For other cases, see Bankruptcy, Cent. Dig. § 23; Dec. Dig. § 20.*

What persons are subject to bankruptcy law, see note to *Mattoon Nat. Bank v. First Nat. Bank*, 42 C. C. A. 4.]

In Bankruptcy. On motions for an adjudication and a restraining order.

*For other cases see same topic & § NUMBER in Dec. & Am. Digs. 1907 to date, & Rep'r Indexes

Charles H. Edmunds, Samuel Scaville, and John Sparhawk, for petitioners.

F. W. Edgar, for receiver appointed by state court.

HOLLAND, District Judge. In this case a receiver had been appointed in the state court more than four months prior to the filing of an involuntary petition in bankruptcy. An order of court has been made directing the state receiver to sell the property which came into his possession as receiver of the bankrupt corporation. This sale is advertised for November 20, 1908. A petition of creditors has been presented and a motion made for an adjudication; also a petition for an injunction to restrain the state receiver from selling this property under the above-mentioned decree of the state court.

It is objected, upon the authority of *Frazer v. Southern Loan & Trust Company*, 99 Fed. 707, 40 C. C. A. 76, and *Metcalf v. Barker*, 187 U. S. 165, 23 Sup. Ct. 67, 47 L. Ed. 122, that, as the state receiver was appointed and took possession of the property more than four months prior to the presentation of the involuntary petition in bankruptcy, this court has no jurisdiction to either enter the adjudication or the restraining order. I am, however, convinced that the corporation, under the circumstances, can be adjudicated a bankrupt for the reasons set forth in the involuntary petition, and an order of adjudication is therefore entered, and the general creditors may present a petition to this court on Friday, November 6th, at 10 o'clock, for the appointment of a receiver.

As to whether or not the court has a right to issue an order restraining the state receiver from selling upon the ground that the general creditors will be irreparably damaged is a question which is not now decided.

GAMMINO v. INHABITANTS OF TOWN OF DEDHAM.

(Circuit Court of Appeals, First Circuit. October 22, 1908.)

No. 751.

1. CONTRACTS (§ 198*)—CONSTRUCTION—CONTRACT FOR CONSTRUCTION OF SEWER.

A contract with a town to furnish all materials and labor required to complete two sections of a sewer according to specifications, which stated approximate quantities of earth and rock excavation required, and provided for the payment of different sums per cubic yard for each and for excavations at different depths, also provided that "the above quantities are not guaranteed, and the commissioners reserve the right to increase or diminish the same within 25 per cent." *Held*, that under such provision the price named for each kind of excavation governed only to the extent of the quantity of such kind stated, with a variation of 25 per cent., and that for the amount of either kind required in excess of that to complete the sections the contractor was entitled to recover on a quantum meruit, although the quantity of excavation as a whole did not vary 25 per cent. from the total stated.

[Ed. Note.—For other cases, see Contracts, Cent. Dig. § 871; Dec. Dig. § 198.*]

2. CONTRACTS (§ 213*)—CONSTRUCTION—CONTRACT FOR CONSTRUCTION OF SEWER—FORFEITURE FOR DELAY IN COMPLETION.

Where, in the execution of the contract, the contractor was obliged to excavate many times the quantity of rock estimated in the contract, a provision that, in case of his failure to complete the work within the time fixed, he should "be liable to a forfeiture of \$10 per day for each and every day which shall be required to fully complete the contract," did not apply to delay caused by such excess of rock excavation above the quantity specified plus 25 per cent.

[Ed. Note.—For other cases, see Contracts, Cent. Dig. § 974; Dec. Dig. § 213.*]

3. EVIDENCE (§ 399*)—PAROL EVIDENCE TO VARY WRITING.

A contractor for the construction of a sewer was required at his peril to acquaint himself with the character of the ground to be excavated before signing the contract, and conversations between the parties in respect thereto which took place previously are not admissible to vary the written contract.

[Ed. Note.—For other cases, see Evidence, Cent. Dig. §§ 1772-1777; Dec. Dig. § 399.*]

4. EVIDENCE (§ 399*)—PAROL EVIDENCE TO VARY WRITING—EVIDENCE OF CUSTOM.

Under a contract for the construction of a sewer, which provided that "the contractor shall make no claim for damages or allowances due to any delays caused by the encountering of any pipes or underground structures, or obstruction of work due to the removal, repair, or renewal of such work by the proper authorities," the contractor is not entitled to recover for delay or expense due to the encountering of water and gas pipes lying in or beside the sewer trench, because they were not shown on plans which were made a part of the contract, nor on proof of a custom or usage to lay such pipes along the sides of the street, instead of near the center, where they were found, and that they were therefore unusual and not contemplated by such provision.

[Ed. Note.—For other cases, see Evidence, Cent. Dig. §§ 1772-1777; Dec. Dig. § 399.*]

*For other cases see same topic & § NUMBER in Dec. & Am. Digs. 1907 to date, & Rep'r Indexes 164 F.—38

5. CONTRACTS (§ 284*)—CONTRACT FOR CONSTRUCTION OF SEWER—PROVISION FOR DETERMINATION OF DISPUTES BY ENGINEER.

A provision of a contract for the construction of a sewer that, in case of any dispute arising, the engineer shall have the right to settle the same and to interpret the meaning of the specifications and contract, and that his decisions shall be final, does not deprive the parties of their right to a judicial construction of the contract after it has been performed, so far as such construction involves matters of law relating to the amount of compensation to which the contractor is entitled.

[Ed. Note.—For other cases, see Contracts, Cent. Dig. §§ 1326-1338; Dec. Dig. § 284.*]

In Error to the Circuit Court of the United States for the District of Massachusetts.

George Fred Williams (James A. Halloran, on the brief), for plaintiff in error.

James E. Cotter and Joseph P. Fagan, for defendant in error.

Before PUTMAN, Circuit Judge, and ALDRICH and BROWN, District Judges.

BROWN, District Judge. This is a writ of error for review of the rulings of the Circuit Court in an action of contract, in which a verdict was directed for the defendant town.

By the written contract between the town, by its commissioners, and the contractor, Gammino, it was agreed that the contractor should furnish all material and perform all labor required upon two sections, A and D, of a sewer.

The location, extent, and general character of the trenching and other work to be done was shown upon plans attached to the contract. Approximate quantities of work to be done were set forth in the specifications, including, among other things, earth excavation and rock excavation at various depths. The contractor was to be paid different sums per cubic yard for earth and rock excavation, and different sums for excavation at different depths. Following the detailed statement of approximate quantities was this language:

"The above quantities are not guaranteed, and the commissioners reserve the right to increase or diminish the same within 25 per cent. Upon the quantities above given bids will be compared. These quantities will be a part of any contract made for the prosecution of this work, and when referred to in such contract include each and every part of the same."

We are of the opinion that, upon a construction of the contract which gives due effect to this provision, the prices named are to prevail only to the extent of the quantities named, with a 25 per cent. margin of variation. The contract fails to fix a price for quantities in excess of this.

The amount of rock excavation necessary to complete the trenches was much more than 25 per cent. in excess of the approximate quantities. The brief of the plaintiff in error states that in section A the rock removed was 18 times the amount of the estimated rock, and in section D 43 times.

*For other cases see same topic & § NUMBER in Dec. & Am. Digs. 1907 to date, & Rep'r Indexes

It clearly appears from the contract that the work contemplated was the entire trenching and construction work of sections A and D. Therefore it cannot be said that an excess of rock excavation over that mentioned in the estimates was extra work, which required special orders from the engineer. It was work in excess of that for which prices were agreed upon, but not work in excess of what was required for the completion of the sewer sections.

Looking at the contract with due regard to its principal object, as well as to the specific provisions, it seems reasonable to hold that it was the intention of the parties, in case the quantities exceeded the estimates by more than 25 per cent., that the contractor might claim on quantum meruit for the excess, and might show that for this excess he was fairly entitled to more than the contract price. On the other hand, the town would be allowed to maintain that on quantum meruit for the excess the contractor was entitled to less than the contract prices.

The limitation to a 25 per cent. variation was inserted for a purpose. Except for this provision, the prices named would prevail for all the work done, even if it should turn out that the actual proportions of earth and rock excavation were substantially different from what was contemplated. An attempt to hold the contractor strictly to the prices named for an amount of work substantially different from what was contemplated might result in hardship so great as to show mutual mistake concerning the subject-matter of the contract, and thus endanger the entire contract.

A more reasonable view is that both parties expected that the proportions of earth and rock excavation would be substantially as set forth, but provided for a variation of 25 per cent. and agreed on prices accordingly, leaving the matter of further possible variations to be adjusted upon the principles of quantum meruit. A clause of this character, read as a provision for future contingencies, should be regarded as inserted for the benefit of both parties.

We are of the opinion that there was error in confining the plaintiff to the prices named for the excess of rock excavation over and above that stated in the estimates of quantities plus 25 per cent.

The auditor found that the sum total of earth and rock excavation did not exceed by 25 per cent. the sum total of the number of cubic yards stated in the estimate for earth and rock excavation, and therefore that the prices named in the contract applied to all rock excavation. Counsel for defendant in error contends that this is in accordance with the proper construction of the contract.

We are of the opinion that this is erroneous, and that it not only violates the terms of the contract, but leads to an unreasonable result.

The different portions of the work are distributed into different classes or quantities because of differences in kind and of cost. These "quantities" embrace such different classes, as pipes of different sizes, figured by linear foot, manholes, lampshafts, chimneys, concrete, foundations, timber cradles, etc., as well as earth and rock excavation.

It is manifest that the 25 per cent. was not intended to be figured upon the sum of all the quantities, because it is impossible to add

together linear feet of pipe, number of manholes and lampshafts, and cubic yards of earth and rock excavation.

The defendant's contention that the right reserved to increase or diminish the quantities within 25 per cent. applied to the quantities as a whole is unreasonable, because the parts or units are incapable of addition. An attempt to figure 25 per cent. of the sum of 10 pounds, 10 linear feet, and 10 cubic feet would present the same difficulty.

Nor did the auditor in fact follow the principle which he adopted; i. e., that the right to vary by 25 per cent. applied to the quantities as a whole. On the contrary, he picked out but two of the quantities, the earth excavation and the rock excavation, and, while he arrived at a sum that could be expressed in cubic yards, the result has no reasonable significance, and involves the fallacious assumption that in the minds of the contracting parties a cubic yard is a cubic yard, whether it is earth, worth from 30 cents to \$3 per yard to excavate, or rock, worth from \$2 to \$7 per yard to excavate.

When the contractor says, "In order to complete the trench I was obliged to excavate several hundred cubic yards of rock more than was estimated," it is no reply to say, "But you were relieved from excavating a corresponding number of cubic yards of earth." The number of yards may balance, but the labor and cost, which are the material things, do not balance.

In connection with the claim of the contractor for rock excavation in excess of the estimated quantity plus 25 per cent., we have to consider the clauses of the contract which provide for a forfeiture by the contractor of the sum of \$10 per day for failure to complete the work within the specified time.

We are of the opinion that, upon a proper construction of the whole contract, the forfeiture or penalty does not apply to the period of delay caused to the contractor by rock excavation necessary for the completion of the trench, but in excess of the amount named in the "quantities" plus 25 per cent.

The work which the contractor agrees to perform within the stipulated time is substantially such work as is within the express provisions of the contract concerning payment, and it would be most unreasonable to charge the contractor for delay during a period when he was engaged in carrying out the main purpose of the contract, and when the delay was due, not to his fault, but to the fact that there was error in the estimates of the proportions of earth and rock excavation.

From our conclusion that the contractor is entitled to claim quantum meruit for excess of rock excavation, it follows that during such period as he is necessarily engaged in excavating the excess he is relieved from the penalty. It was error to charge against the contractor the sum of \$10 per day during this period.

This follows, whether the provision for a forfeiture of \$10 per day be regarded as an agreement for liquidated damages or for a strict forfeiture. In connection with the provision that, if the contractor fails to complete the work within a specified time, "he shall be liable to a forfeiture of \$10 per day for each and every day which shall be required to fully complete the contract," etc., the town

contents that the agreement is for liquidated damages; the contractor, that it is for a strict forfeiture. The determination of this question, however, requires a careful consideration of *Van Buren v. Digges*, 11 How. 461-476, 13 L. Ed. 771, *Clark v. Barnard*, 108 U. S. 436-455, 27 L. Ed. 780, *Sun Printing Company v. Moore*, 183 U. S. 642, 22 Sup. Ct. 240, 46 L. Ed. 366, *United States v. Bethlehem Steel Company*, 205 U. S. 105, 27 Sup. Ct. 450, 51 L. Ed. 731, and other decisions touching the same topic. Furthermore, the application of these authorities may vary with a different state of proof.

Therefore, without determining this question, and without precluding its consideration by the Circuit Court upon a new trial, we content ourselves with holding that, whether the contract provides for liquidated damages or for a penalty, there was error in charging the contractor for delay, when delay was due, not to his fault, but to error in the estimates.

From what precedes, it follows that judgment must be reversed; but for the purposes of a new trial it may be expedient to consider some of the other points argued.

The plaintiff attempted to introduce conversations between himself and the sewer commissioners, immediately preceding the signing of the contract, relating to the character of the ground through which the sewer was to be constructed.

The excluded evidence was to the effect that the contractor stated to the commissioners that he had been over the ground, and thought it likely to be wet and hard, and for that reason he preferred not to sign the contract, but to forfeit the deposit he had made with his bid, and that thereupon two of the commissioners, in the presence of the third, assured him to the contrary, and that the work was easy, dry, and light.

This evidence was properly excluded. The contract itself speaks expressly upon this subject. The contractor was required to acquaint himself with particulars of this kind at his own risk. The written contract is drawn to preclude contentions of this familiar kind. By signing it the plaintiff precluded himself from contending, directly or indirectly, that it was agreed that the soil was dry and easy to work. Moreover, the evidence clearly shows that before signing the contract the plaintiff made an examination of the ground. The rejection of this evidence is fully supported by the familiar rule which forbids variation of a written contract by proof of antecedent oral conversations upon the same subject-matter.

The plaintiff in error also assigns as error the rejection of certain evidence as to customs and usages. The plaintiff claimed that he had suffered loss from delay, and had been put to expense from the fact that in excavating he encountered in section A about 4,300 feet of water and gas pipes lying in, on the side of, and paralleling the trench, and that these pipes were not shown on the plans. He also claimed that on section D there were 1,650 feet of such pipes. He contended that these obstructions were not contemplated by the parties, made the necessary work substantially different from that for which prices were agreed, excused him from delay in the com-

pletion of the sewer sections, and put him to extra expense, for which he claimed additional compensation. The defendant contended that these claims were precluded by the express terms of the contract. The following provisions of the specification are referred to:

"Care of Underground Structures, Water and Gas Pipes, Street Drains, and Street Railway Tracks. The contractor must take care of all retaining walls, foundation walls, buildings, water and gas pipes, and of all drains and pipes and other structures of whatever nature which he encounters in the trench work and in the laying of the sewers. He shall properly support and take care of all such pipes, and properly notify the proper authorities when such pipes or drains are encountered, and shall make all necessary arrangements with the proper authorities for their support, repair, removal, or renewal, as may be necessary in the prosecution of his work. The contractor will not be required under these specifications to relay any water pipes or gas pipes in new locations, or to remove such pipes from the trench when such relocations are required, but shall properly guard and protect such pipes until such removal or relocation has been made by the proper authorities. In all cases the contractor shall make no claims for damages or allowance due to any delays caused by the encountering of any pipes or underground structures or obstruction of work due to the removal, repair, or renewal of such work by the proper authorities. All such pipe crossing and work shall be at his expense and in his care, and he shall save the town harmless from any liability in this respect as against the pipes of the Dedham Water Company and the Dedham & Hyde Park Gas & Electric Light Company, except that the contractor will be paid for concrete ordered by the engineer to support drains."

The plaintiff contends that this clause applies only to ordinary cross-pipes, and to such pipes as are ordinarily encountered in trenching, but does not apply to pipes lying in the trench location, or closely parallel thereto, of such extent as those found, drawing attention to the following clause in support of this construction: "All such pipe crossing and work shall be at his expense and in his care," etc. He further contends that the provision, "All bidders must visit the ground in person and thoroughly acquaint themselves with all particulars in regard to the character and nature of the work," had no reference to an unusual obstruction of this character.

The testimony of Samuel M. Grey, a civil engineer, was offered to show that:

First. It was a custom to lay water pipes on one side of a street, gas pipes on the other, and sewer pipes in the middle of the street.

Second. It was a custom to describe on construction plans any underground obstructions of an unusual character connected with gas and water pipes which run in the line of the trench, or to state the fact if the obstructions are unknown.

Third. It was a custom, when such obstructions are not so shown on the plan or indicated as uncertain, to treat and pay for any work done thereon as extra work.

Fourth. The actual cost of trench work is increased by the presence of such unusual obstructions in the trench.

The plaintiff also offered to prove the extent to which these unusual obstructions existed in the trenches, how much his work was delayed thereby, and how much the cost of the work was increased.

We are of the opinion that there was no error in the rejection of this evidence. The contract is clearly expressed in terms of ordi-

nary speech, and the evidence was not offered to explain, but to restrict, the meaning of these terms. The contractor expressly assumed the risk of encountering pipes and of expense to him in consequence. The contract names specifically the pipes of the Dedham Water Company and the Dedham & Hyde Park Gas & Electric Light Company, and covers broadly all pipes that may be encountered in the work, whether their presence was known or unknown. The intention of the parties is fully expressed, and such expression cannot be contradicted or modified by extraneous proof.

As a matter of interpretation it is apparent that this provision was inserted for the protection of the town against all claims arising from the encountering of pipes, and the evidence that pipes were found in unusual places or in unusual quantities, or that the contractor was put to greater expense than he expected, has no bearing upon the proper construction of the terms used by the parties.

The contention is in effect that the contract should be given a meaning narrower than that to be found in its terms, merely for the reason that the conditions found were unexpected by the contractor and put him to unexpected expense. It assumes that the parties were contracting entirely on the basis of known and previously ascertained conditions; an assumption which is not justified by the text of the contract or by the nature of the undertaking. Furthermore, the result would be to throw upon the town the expense arising from unforeseen obstructions when it is manifest that it was the intention of the parties, as expressed in the contract, that the risk should fall on the contractor.

The contention is also made that, as the obstructions encountered were not shown upon the plans, the contractor was entitled to assume that there were no unusual obstructions. The fact that the plans were a part of the contract and show no obstructions clearly cannot amount to a representation that there are no obstructions, when the text of the contract expressly provides for obstructions. The plans did not purport to show obstructions, and, though made a part of the contract, are not the part which deals with the question of obstructions.

We are further of the opinion that, even if evidence of usage or custom were admissible, the evidence offered was insufficient and incompetent. There was no attempt to show that terms such as are used in this contract had acquired by usage any particular or restricted meaning. The questions as to usage were too general, and without limitation to time or place, or to circumstances similar to those involved in this case; and it is further apparent that the word "custom" was used, not in the sense of a uniform and invariable practice, but merely in the sense of the usual or ordinary way. The contentions that there was a custom to lay water and gas pipes on the sides of the street, and another custom to have the plans show water and gas pipes when laid otherwise, are of doubtful consistency. If the first custom exists, there would appear to be hardly room for the second. The fact that the conditions found to exist when the ground was opened were merely unusual or unexpected would be altogether insufficient to make applicable to this case the principle

that parties who contract upon a subject-matter concerning which an established custom prevails proceed with a tacit assumption of such usage. The case is of the class to which the rule is applicable that where the terms of the contract are plain the right of one party to it cannot be taken away by proof of custom. *Boruszweski v. Middlesex*, 186 Mass. 589-593, 72 N. E. 250; *Brown v. Foster*, 113 Mass. 136, 18 Am. Rep. 463. The language of the opinion in *Seitz v. Brewers Refrigerating Co.*, 141 U. S. 517, 12 Sup. Ct. 48, 35 L. Ed. 837, is applicable:

"Whether the written contract fully expressed the terms of the agreement was a question for the court, and since it was in this instance complete and perfect on its face, without ambiguity, and embracing the whole subject-matter, it obviously could not be determined to be less comprehensive than it was."

The town further insists upon the provision of the contract:

"In case of any dispute arising the engineer shall have the right to settle the same, and he shall have the right to determine and interpret the meaning of these specifications and contract to be made under them, and all decisions of the engineer shall be final."

The jurisdiction of the engineer relates to disputes arising in the performance of the work which might prevent the work from progressing unless determined on the spot. The questions now presented are those which arose after the completion of the contract. The clause cannot be interpreted so as to deprive the parties of their rights to a judicial construction of the contract, so far as such construction involves matters of law relating to the present right of the plaintiff to maintain suit, and relating to the question whether the plaintiff has received such compensation as he was legally entitled to under the provisions of the contract and under the evidence as to the acts of the parties not in terms fully covered by the express provisions of the contract.

The judgment and verdict are set aside, and the case is remanded to the Circuit Court for further proceedings not inconsistent with this opinion, and the plaintiff in error recovers his costs of appeal.

CITY OF MEMPHIS v. POSTAL TELEGRAPH & CABLE CO.

(Circuit Court of Appeals, Sixth Circuit. November 9, 1908.)

Nos. 1,811, 1,812, 1,813, 1,814.

1. APPEAL AND ERROR (§ 1022*)—REVIEW—FINDINGS OF MASTER APPROVED BY COURT.

Where a cause is referred to a master, to take proof and to report on certain questions, and this is done, and the court concurs in the conclusions of the master, they are to be taken as presumptively correct, and should be permitted to stand, unless some obvious error or mistake has intervened, either in the law or in the consideration of the evidence.

[Ed. Note.—For other cases, see Appeal and Error, Cent. Dig. § 4015; Dec. Dig. § 1022.*]

*For other cases see same topic & § NUMBER in Dec. & Am. Digs. 1907 to date, & Rep'r Indexes

2. TELEGRAPHS AND TELEPHONES (§ 10*)—USE OF STREETS—RENTALS.

The finding of a master that a charge by a city of \$3 per pole as rental for the occupancy and use of its streets by telegraph companies was reasonable *held* sustained by the evidence.

[Ed. Note.—For other cases, see *Telegraphs and Telephones*, Dec. Dig. § 10.*

Rights of telegraph and telephone companies to use of streets, see note to *Southern Bell Telegraph & Telephone Co. v. City of Richmond*, 44 C. C. A. 155.]

Appeals from the Circuit Court of the United States for the Western District of Tennessee.

See, also, 139 Fed. 707.

J. L. McRee, for city of Memphis.

R. A. Greer, for Western Union Telegraph Co.

H. D. Minor, for Postal Telegraph & Cable Co.

Before LURTON, SEVERENS, and RICHARDS, Circuit Judges.

RICHARDS, Circuit Judge. These cases were filed in Shelby county, Tenn., and on account of diversity of citizenship removed to the court below. They were brought to collect the rentals per pole charged by the city of Memphis for the occupancy and use of its streets. The court below sustained demurrers and dismissed the suits on the ground the ordinances under which the rentals were laid were invalid. We reversed these decrees, holding the ordinances valid, but leaving unsettled the questions whether the rental of \$2 per pole from 1896 to 1901, and \$3 per pole since 1902, were respectively unreasonable and excessive.

The cases were remanded, with the opinion in *City of Memphis v. Postal Tel. & Cable Co.*, 145 Fed. 602, 76 C. C. A. 292, for the purpose of referring them to a master to take proof and report upon the questions whether the rentals were unreasonable and excessive. The master took proof and reported, sustaining the rentals under each ordinance, that of 1894 and that of 1902, being \$2 from 1896 to 1901, inclusive, and \$3 since 1902. Exceptions were taken. The court below sustained the exception to the rental of \$3 per pole fixed by the ordinance of 1902 as unreasonable and excessive, but overruled that to the rental of \$2 per pole as fixed by the ordinance of 1894, and rendered judgments accordingly.

We have given careful consideration to the reargument of the fundamental questions whether the city had authority to pass the ordinances of 1894 and 1902, and we are constrained to stand by the conclusion, which is set out quite clearly and with sufficient authority, in the opinion in 145 Fed. 602, 76 C. C. A. 292. This leaves the questions referred to the master, upon which he took proof and reported, the only ones necessary to consider, namely, whether the rental of \$2 per pole per annum from 1896 to 1901, inclusive, and that of \$3 per pole per annum since 1902, were unreasonable and excessive. The master sustained both of these rentals as reasonable when laid, but held that the rental of \$2 per pole

*For other cases see same topic & § NUMBER in Dec. & Am. Digs. 1907 to date, & Rep'r Indexes

was inadequate, after the ordinance fixing the rental at \$3 per pole was passed. The court, on the other hand, held that the rental of \$2 per pole was reasonable, but that the rental of \$3 per pole was unreasonable and excessive.

The situation, therefore, as it stands at present, is this: The court below and the master agree in concluding that the rental of \$2 per pole per annum, as fixed by the ordinance of 1894, was reasonable and not excessive; but the court below disagrees with the master by holding that the rental of \$3 per pole per annum, as fixed by the ordinance of 1902, amending that of 1894, was unreasonable and excessive. It is left to this court to settle the conflict, and we are clear in the opinion that it should be settled in favor of the conclusions reached by the master. The increase of the rental in the second ordinance might well be justified by general conditions. After all, a fair estimate of the rental per pole which should be charged per annum, under the circumstances, seems to have been a matter of opinion. The witnesses were not permitted to take into account any element of value resulting from the consideration that the occupation and use of the poles by the company was either a privilege or a license. This appears to have resulted from the fact that the right being exercised was proprietary in its nature, and for this right a rental should be charged. But at the same time that the witnesses were restricted in the way we have indicated, their attention was not directed to the fact that the proprietary right of the telegraph company was not restricted to the occupation and use of the ground where a pole stood merely; and you could not properly limit the value of that occupation and use by the size of the pole. The pole carried cross-arms, and the cross-arms insulators and wires. The cross-arms, insulators, wires, and cables enjoy a part of the proprietary right of the company, as well as the poles.

In the case of *St. Louis v. Western Union Tel. Co.*, 148 U. S. 92, 13 Sup. Ct. 485, 37 L. Ed. 380, an ordinance came before the Supreme Court imposing the sum of \$5 per annum for each telegraph or telephone pole for the privilege of using the streets, alleys, and public places. The court, after indicating the view that the city of St. Louis could exact a charge for the use of its streets, set the case for rehearing (149 U. S. 465, 13 Sup. Ct. 990, 37 L. Ed. 810), upon the question "whether the city of St. Louis has such interest in and control over the streets, alleys, and public places within its limits as authorizes it to impose upon the telegraph company a charge in the nature of a rental for the exclusive use of portions thereof in the manner stated." In the second opinion by Mr. Justice Brewer, speaking for the court, the rental was sustained. These cases were decided in March and May, 1893. Afterwards, in June, 1894, in the case of *Postal Telegraph Company v. Mayor, etc., of Baltimore*, 79 Md. 502, 29 Atl. 819, 24 L. R. A. 161, the right of Baltimore to impose a tax of \$2 per annum for each telegraph, telephone, electric light, or other pole used in any of the streets of Baltimore, came before the Court of Appeals

of Maryland and was sustained. The cases in the Supreme Court are cited and followed in the opinion. This case in its turn came before the Supreme Court in *Postal Tel. & Cable Co. v. Baltimore*, 156 U. S. 210, 15 Sup. Ct. 356, 39 L. Ed. 399, and was affirmed on the authority of *St. Louis v. Western Union Co.*, 148 U. S. 92, 13 Sup. Ct. 485, 37 L. Ed. 380. The charge of \$5 per annum for each pole is referred to in the opinion. 79 Md. 513, 29 Atl. 819, 24 L. R. A. 161.

In the case of *Western Union Tel. Co. v. New Hope*, 187 U. S. 419, 23 Sup. Ct. 204, 47 L. Ed. 240, an ordinance passed by the borough of New Hope, Pa., imposing an annual license fee of \$1 per pole and \$2.50 per mile for wire on the telegraph, telephone, and electric light poles and wires within its limits, was assailed on the ground that the charge was excessive. The Supreme Court met this objection by pointing out that all the courts in Pennsylvania, the common pleas, superior, and Supreme, had held it to be reasonable. It cited the *St. Louis Cases* in 148 U. S. 92, 13 Sup. Ct. 485, 37 L. Ed. 380, and 149 U. S. 465, 13 Sup. Ct. 990, 37 L. Ed. 810, as showing that a license fee was not a tax either upon the property of the company or upon its transmission of the messages, upon its receipts from such transmission or upon its occupation or business, but was a charge in the enforcement of local governmental supervision, and as such was not in itself obnoxious to the clause of the Constitution relied on.

In the case of *Atlantic & Pacific Tel. Co. v. Philadelphia*, 190 U. S. 160, 23 Sup. Ct. 817, 47 L. Ed. 995, the right of the city of Philadelphia to impose and collect certain license fees against the company was sustained, and the court takes great care to distinguish between those exactions which may and those which may not be laid under the federal Constitution. It was sustained as a reasonable license fee for the enforcement of local governmental supervision. 190 U. S. 164, 23 Sup. Ct. 817, 47 L. Ed. 995.

The rule is settled that where a cause is referred to a master to take proof and to report upon certain questions, and this is done, and the court concurs in the conclusions of the master, they are to be taken as presumptively correct, and should be permitted to stand, unless some obvious error or mistake has intervened, either in the application of the law or in the consideration of the evidence. *Furrer v. Ferris*, 145 U. S. 132, 134, 12 Sup. Ct. 821, 36 L. Ed. 649. In the present case the court below overruled the master with respect to the \$3 rental. It is, then, for us to say whether such rental is so unreasonable and excessive as to invalidate the ordinance of 1902, which we held to be valid unless overcome by the evidence in this case showing it unreasonable and excessive. *Medsker v. Bonebrake*, 108 U. S. 66, 72, 2 Sup. Ct. 351, 27 L. Ed. 654.

Holding, as we do, that it was error in the court below to overrule the master with respect to the \$3 rental, the judgments below are reversed, and the cases remanded for judgments in accordance with this opinion.

McGILVRA et al. v. ROSS, State Land Com'r, et al.

BRESSLER v. SAME.

(Circuit Court of Appeals, Ninth Circuit. October 12, 1908.)

No. 1,565.

1. COURTS (§ 405*)—FEDERAL COURTS—QUESTIONS OF JURISDICTION.

The question of the jurisdiction of the Circuit Court, where it appears on the record on an appeal to the Circuit Court of Appeals, cannot be ignored, but must be determined by that court in disposing of the appeal, although not made a ground of appeal.

[Ed. Note.—For other cases, see Courts, Dec. Dig. § 405.*]

2. COURTS (§ 282*)—FEDERAL QUESTION.

Const. Wash. art. 17, § 1, which asserts the ownership by the state of the beds and shores of all navigable waters therein, but expressly provides that it shall not be construed so as to debar any person from asserting his claim to vested rights in the courts of the state, is not in violation of the federal Constitution, as depriving riparian owners under previous grants from the United States of their property without due process of law, nor does a suit by such owners to enjoin officers of the state from selling shore lands under a statute enacted pursuant to such provision involve any constitutional question, which gives a federal court jurisdiction thereof.

[Ed. Note.—For other cases, see Courts, Dec. Dig. § 282.*]

3. COURTS (§ 285*)—FEDERAL QUESTION.

Patents issued by the United States under general laws to lands in a territory bordering on navigable waters do not convey by their own force title below high-water mark, but leave the question of the ownership and use of the shores to the sovereign control of the state when organized; and, the law having been so declared by the Supreme Court of the United States, a suit by grantees of such lands to enjoin a sale of adjoining shore lands by the state does not involve the construction of any law of the United States, which gives a federal court jurisdiction.

[Ed. Note.—For other cases, see Courts, Dec. Dig. § 285.*]

Jurisdiction in cases involving federal question, see notes to *Bailey v. Mosher*, 11 C. C. A. 308; *Montana Ore-Purchasing Co. v. Boston & M. C. C. & S. Min. Co.*, 35 C. C. A. 7.]

Appeal from the Circuit Court of the United States for the Northern Division of the Western District of Washington.

For opinion below, see 161 Fed. 398.

Actions in equity to restrain the defendants, as officers of the state of Washington, from platting, selling, and offering for sale, and contracting for the sale of, any of the shore lands of Lake Washington and Lake Union, in said state, lying in front of the lands owned by complainants, and described in their respective bills of complaint.

Chas. K. Jenner (William Martin, of counsel), for appellants.

John D. Atkinson, Atty. Gen., E. C. MacDonald, Asst. Atty. Gen., Donald F. Kizer (J. B. Alexander and I. B. Knickerbocker, Asst. Attys. Gen., and John W. Roberts, of counsel), for appellees.

Before GILBERT, ROSS, and MORROW, Circuit Judges.

*For other cases see same topic & § NUMBER in Dec. & Am. Digs. 1907 to date, & Rep'r Indexes

MORROW, Circuit Judge. The controversy in these two cases relates to the rights of the complainants, as alleged riparian owners, with respect to certain lands on the shores of Lakes Washington and Union, in the state of Washington, lying in front of lands owned by the complainants. In the court below demurrers were interposed to the bills of complaint on the grounds that they did not state facts sufficient to entitle plaintiffs to the relief prayed for and that the court was without jurisdiction of the parties or the subject-matter. The court sustained the demurrers and dismissed the bills for want of equity, without discussing the question of jurisdiction. It is not alleged in either complaint that there is a diversity of citizenship with respect to the parties to the action. The jurisdiction of the Circuit Court did not rest, therefore, on diverse citizenship, and, unless the cases arose under the Constitution and laws of the United States, the jurisdiction of the Circuit Court was not properly invoked, and should not have been maintained. *Defiance Water Company v. Defiance*, 191 U. S. 184, 190, 24 Sup. Ct. 63, 48 L. Ed. 140.

The question of jurisdiction of the Circuit Court was not discussed on appeal in this court; but, as said by the Supreme Court in the case just cited:

"The fundamental question of jurisdiction, first of this court, and then of the court from which the record comes, presents itself on every writ of error or appeal, and must be answered by the court, whether propounded by counsel or not."

When the jurisdiction of the Circuit Court is in issue, the question is proper to be determined by the Supreme Court, as provided by Act March 3, 1891, c. 517, § 5, 26 Stat. 827 (U. S. Comp. St. 1901, p. 549). But where the question appears in the record, in a case brought to this court as one arising under the Constitution and laws of the United States, it cannot be ignored and must be determined in disposing of the appeal. The jurisdiction of the Circuit Court upon constitutional grounds is based upon the following allegations contained in the bills of complaint (as the alleged rights are identical in both cases, reference will be made to the bill of complaint in the *McGilvra Case*):

It is alleged that the lands described in the complaint were purchased from the United States prior to the admission of the state of Washington into the Union; that said lands touched the waters of Lake Washington, and that the waters of Lake Washington constituted and were the boundary of the tracts conveyed as to every portion of said tracts touched by said lake; that the complainants became and were vested with the ownership of those portions of said Lake Washington immediately in front of the respective tracts out into said lake to the deep waters thereof. It is alleged that, under section 1 of article 17 of the Constitution of the state of Washington, the state of Washington asserts its ownership to the beds and shores of all navigable waters in the state up to and including the line of ordinary high water within the banks of all navigable rivers and lakes; that by virtue and authority of this provision of the Constitution the state of Washington claims the ownership in fee of all the waters and lands under water of Lake Washington, up to and including the line of ordinary high

water, and by reason of said claims of ownership the Legislature of the state of Washington passed the acts mentioned in the complaint, providing for the sale of such lands, and that said constitutional provision seeks to confiscate without compensation, and if declared valid and of effect will confiscate without compensation, the rights of the complainants set forth in the complaint, and will divest the plaintiffs of their said property rights without compensation and without due process of law, all of which it is alleged is contrary to the protection guaranteed to the citizens of the United States by the fourteenth amendment to the Constitution of the United States. And it is charged that the defendants, acting under the authority of the Constitution and laws of the state, are preparing to sell, and threaten to and will sell, the shore lands of Lake Washington lying in front of their lands, and threaten to take and convert into money the properties described belonging to complainants, without compensation to complainants and without due process of law, to the irreparable injury and damage of the complainants.

With respect to the constitutional provision of the state of Washington, it is sufficient to say that, while it asserts the ownership of the state in the beds and shores along navigable waters in the state, it expressly provides that it "shall not be construed so as to debar any person from asserting his claim to vested rights in the courts of the state." There is, therefore, nothing in this constitutional provision depriving the complainants of any of their constitutional rights, nor is there anything in the statute of the state referred to in the complaint that deprives plaintiffs of their property without due process of law. In *Newburyport Water Co. v. Newburyport*, 193 U. S. 561, 576, 24 Sup. Ct. 553, 556, 48 L. Ed. 795, the Supreme Court said:

"If jurisdiction is to be determined by the mere fact that the bill alleged constitutional questions, there was, of course, jurisdiction. But that is not the sole criterion. On the contrary, it is settled that jurisdiction does not arise simply because an averment is made as to the existence of a constitutional question, if it plainly appears that such averment is not real and substantial, but is without color of merit."

In *Devine v. Los Angeles*, 202 U. S. 313, 322, 26 Sup. Ct. 652, 657, 50 L. Ed. 1046, the court said:

"There being no diversity of citizenship, the jurisdiction of the Circuit Court could only be maintained upon the ground that the suit arose under the Constitution or laws or treaties of the United States, and a suit does not so arise unless it really and substantially involves a dispute or controversy as to the effect or construction of the Constitution or some law or treaty of the United States upon the determination of which the result depends."

It is clear that the averments of the bills do not state any real or substantial question arising under the Constitution of the United States. Do they allege any question arising under any law of the United States? It is alleged in the complaint in the *McGilvra Case* that complainant's lands were purchased under the provisions of the act of Congress of the 24th of April, 1820, "An act making further provision for the sale of the public lands," approved April 24, 1820 (3 Stat. 566, c. 51), and in the *Bressler Case* that complainant's land was entered under the act of Congress of September 27, 1850, en-

titled "An act to create the office of surveyor general of the public lands in Oregon, and to provide for the survey and to make donations to settlers of the said public lands" (9 Stat. 496, c. 76). The mere assertion of a title to lands derived by the complainants under and by virtue of a patent granted by the United States presents no question which of itself confers jurisdiction on a court of the United States. *Blackburn v. Portland Gold Mining Co.*, 175 U. S. 571, 20 Sup. Ct. 222, 44 L. Ed. 276; *Florida Central, etc., R. R. v. Bell*, 176 U. S. 321, 20 Sup. Ct. 399, 44 L. Ed. 486; *Shoshone Mining Co. v. Rutter*, 177 U. S. 505, 20 Sup. Ct. 726, 44 L. Ed. 864; *De Lamar's Nevada G. M. Co. v. Nesbitt*, 177 U. S. 523, 20 Sup. Ct. 715, 44 L. Ed. 872. In *Packer v. Bird*, 137 U. S. 661, 11 Sup. Ct. 210, 34 L. Ed. 819, the question was whether the title of an owner of land bordering on a navigable river above the ebb and flow of the tide extended to the middle of the stream. The court held that:

"The courts of the United States will construe the grants of the general government without reference to the rules of construction adopted by the states for their grants; *but whatever incidents or rights attach to the ownership of property conveyed by the government will be determined by the states*, subject to the limitation that their rules do not impair the efficiency of the grant or the use and enjoyment of the property by the grantee. As an incident of such ownership the right of the riparian owner, where the waters are above the influence of the tide, will be limited according to the law of the state, either to low or high water mark, or will extend to the middle of the stream."

But the complainants claim that, as the grants in these cases were made by the United States prior to the admission of the state of Washington into the Union, the law of the United States prevailing at that time determines the rights, privileges, and appurtenances of the lands granted, and not the law of the state subsequently organized from that territory. This claim cannot be sustained. In the case of *Joy v. St. Louis*, 201 U. S. 332, 26 Sup. Ct. 478, 50 L. Ed. 776, the complainant claimed title to a lot in St. Louis, in the state of Missouri, derived from a patent issued under the act of Congress approved March 3, 1807 (2 Stat. 440, c. 36), and a confirmation of the grant made by the act of Congress approved June 13, 1812 (2 Stat. 748, c. 99), and an act obviating the necessity of issuing patents for certain private land claims in the State of Missouri and for other purposes, approved June 6, 1874 (18 Stat. 62, c. 223 [U. S. Comp. St. 1901, p. 1512]). Missouri was admitted into the Union August 10, 1821. The original grant and its confirmation under the acts of Congress of March 3, 1807, and June 13, 1812, was, therefore, made by the United States while Missouri was a territory. The question was as to the boundary of the grant on the Mississippi river. The court held that the question was one of local or state law, and not one of a federal nature, citing *Sweringen v. St. Louis*, 185 U. S. 38, 22 Sup. Ct. 569, 46 L. Ed. 795; *St. Anthony Falls, etc., Co. v. St. Paul Water Commissioners*, 168 U. S. 349, 359, 18 Sup. Ct. 157, 42 L. Ed. 497, and *Packer v. Bird*, 137 U. S. 661, 11 Sup. Ct. 210, 34 L. Ed. 819. The court also cites *Shively v. Bowlby*, 152 U. S. 1, 14 Sup. Ct. 548, 38 L. Ed. 331. In the latter case the controversy related to certain lands below high-water mark in the Columbia river in the state of Oregon. The

plaintiffs derived their title from the state of Oregon, the defendants obtained title from the United States while Oregon was a territory, and the question was whether the grant from the United States bounded by the Columbia river passed any right or title to lands below high-water mark as against subsequent deeds from the state of Oregon. The Supreme Court of the state of Oregon held that it did not. *Bowlby v. Shively*, 22 Or. 410, 30 Pac. 154. The Supreme Court of the United States, affirming this decision, said:

"The United States, while they hold the country as a territory, having all the powers both of national and municipal government, may grant, for appropriate purposes, titles or rights in the soil below high-water mark of tide waters; but they have never done so by general laws, and, unless in some case of international duty or public exigency, have acted upon the policy, most in accordance with the interest of the people and with the object for which the territories were acquired, of leaving the administration and disposition of the sovereign rights in navigable waters and in the soil under them to the control of the states, respectively, when organized and admitted into the Union."

The court further said:

"Grants by Congress of portions of the public lands within a territory to settlers therein, though bordering on or bounded by navigable waters, convey, of their own force, no title or right below high-water mark, and do not impair the title and dominion of the future state when created, and leave the question of the use of the shores by the owners of uplands to the sovereign control of each state, subject only to the rights vested by the Constitution in the United States." *Shively v. Bowlby*, 152 U. S. 58, 14 Sup. Ct. 570 (38 L. Ed. 331).

The act of Congress of September 27, 1850, involved in *Shively v. Bowlby*, is the act of Congress involved in the *Bressler Case*; and the acts of Congress involved in *Joy v. St. Louis*, like the acts of Congress involved in the *McGilvra Case*, related to grants of title by the United States to land which in the particular case fronted on navigable waters. In other words, the decisions of the Supreme Court in the two cases cited are applicable to these two cases now before the court; and, it having been determined by the Supreme Court that the acts of Congress involved in these cases do not of their own force convey any title or right below high-water mark, and do not impair the title or dominion of the state subsequently created, the bills of complaint in the present cases do not present any question arising under the laws of the United States. This question having been determined by the Supreme Court, it is no longer a question arising under a law of the United States. *Kansas v. Bradley* (C. C.) 26 Fed. 289; *Montana Ore Purchasing Co. v. Boston & M. C. C. & S. Min. Co.*, 57 U. S. App. 13, 29 C. C. A. 462, 85 Fed. 867; *Blue Bird Min. Co. v. Largey* (C. C.) 49 Fed. 289, 291; *Inez Mining Co. v. Kinney* (C. C.) 46 Fed. 832, 834; *Western Union Tel. Co. v. Ann Arbor R. Co.*, 178 U. S. 239, 20 Sup. Ct. 867, 44 L. Ed. 1052.

The Circuit Court was, therefore, without jurisdiction in these cases, and the bills of complaint were properly dismissed. The views here expressed would require this court to affirm the decrees of the Circuit Court dismissing the bills of complaint, if the cases were considered on their merits.

The decree of the Circuit Court is affirmed.

PEARCE v. SUTHERLAND et al.

(Circuit Court of Appeals, Ninth Circuit. October 12, 1908.)

No. 1,549.

1. PARTNERSHIP (§ 269*)—SUIT FOR DISSOLUTION—PARTIES.

The formation, by a partnership for dealing in real estate, of a corporation merely as a holding company for the partnership adventures, does not operate as a dissolution of the partnership; and one partner may maintain a suit in equity against his copartner, who holds practically all of the stock of the corporation as trustee for the partnership, for a dissolution of the partnership and an accounting in respect to such stock, and to such a suit the corporation is a proper party defendant.

[Ed. Note.—For other cases, see Partnership, Dec. Dig. § 269.*]

2. CORPORATIONS (§ 614*)—SUIT BY STOCKHOLDER FOR DISSOLUTION—EQUITY JURISDICTION.

In the absence of a statute enlarging its powers, a court of equity has no jurisdiction at the suit of a stockholder or other private person to dissolve a corporation, or to appoint a receiver to control the corporation, the effect of which will be to dissolve it, especially where the defendant is a foreign corporation, although doing business within the jurisdiction of the court.

[Ed. Note.—For other cases, see Corporations, Dec. Dig. § 614.*]

Appeal from the District Court of the United States for Division No. 1 of the District of Alaska.

The appellant appeals from a decree sustaining demurrers to his third amended bill and dismissing the same. In substance the bill alleges the following facts: That in 1901 one Joseph T. Gilbert, the owner of a group of lode mining claims in the Harris mining district, Alaska, proposed to the appellant that, if he could find a purchaser of the same for the sum of \$200,000, he would pay for such services a fee largely in excess of the usual commission on such sales. That the appellant, who is an expert miner and mining engineer of experience, accepted the offer, and in quest of a purchaser went to the appellee Sutherland, a promoter and seller of mines, who represented that he was well and favorably known in financial circles in New York and London, and could there interest persons financially to purchase said property at a sum far in advance of \$200,000. That said Sutherland proposed that he and the appellant enter into a copartnership for the sale and promotion of mining claims, especially the said Gilbert group of mines, and such others as they might obtain control of, and that they procure from said Gilbert a bond and option to purchase his said group of mines, and that the appellant return to Alaska, explore said group, and demonstrate its value, and that Sutherland go to financial marts and interest investors and procure funds to open, explore, promote, and sell the same, for the benefit of such copartnership, and find and procure, in addition to the money necessary for such development, a monthly allowance to the appellant while he was so engaged in opening and developing said mines. That the proposition was agreed to, and the copartners went to New York, where the appellant obtained from Gilbert a bond to purchase his mines in consideration of \$200,000 which bond, at the instance of Sutherland, was taken in the latter's name for the use and benefit of the copartnership. That thereupon a copartnership agreement was made between the appellant and Sutherland, which provided that they should work together in obtaining, promoting, and disposing of all properties in which they were then or should thereafter become jointly interested, and that out of the net profits received by Sutherland he should pay and deliver to the appellant one-third thereof in money, bonds, and stocks, and that out of the net profits received by the appellant he should pay and de-

*For other cases see same topic & § NUMBER in Dec. & Am. Digs. 1907 to date, & Rep'r Indexes 164 F.—39

liver to said Sutherland one-half thereof in money, bonds, and stocks. That after the execution of said agreement Sutherland proposed to the appellant to form a corporation under the laws of New York to take over the record title to said option, and thereafter the record title to be acquired from said Gilbert to said group of mines, the corporation to be known as the "Alaska Perseverance Mining Company," and to be incorporated for the sole purpose of holding the bare legal title to the mining claims and other property of the copartnership, in trust for the use and benefit of the appellant and said Sutherland, the capital stock to be \$500,000, divided into 100,000 shares, and that immediately after the organization of said corporation Sutherland should convey to it the said bond and option, and said corporation should in return therefor issue to Sutherland, for the joint use of the appellant and himself, 99,995 shares of the capital stock. That thereupon the Alaska Perseverance Mining Company was incorporated under the laws of New York, as suggested. That 5 shares of the capital stock were subscribed for by the five incorporators, among whom were the appellant and Sutherland, and that no other shares were then issued or subscribed. That the subscribing incorporators were elected the board of directors of the corporation, and the bond and option were transferred by Sutherland to the corporation, and he received from the corporation the 99,995 shares still held in the treasury, which shares were taken in trust by Sutherland for the benefit of himself and the appellant. That the bond was transferred to the corporation for the sole purpose of making the corporation a trustee to hold the same for the use and benefit of said Sutherland and the appellant. That thereafter the appellant returned to the mines and entered upon the operation, management, and development of the same, as superintendent of the corporation, and said Sutherland, who was made president of the corporation, obtained money in New York, London, and Paris upon the faith and credit of said capital stock for the development of said mines and for the payment of the appellant's monthly salary of \$300. That the appellant, upon the advice and recommendation of Sutherland, located certain other claims for said partnership in the name of the corporation, to be held by it in trust for the benefit of Sutherland and the appellant, and the said claims so located are of great value, and of far greater value than those in the original Gilbert group of mines. That from the summer of 1901 until July, 1905, the appellant remained constantly upon said mining claims and properties, projecting the development and developing paying ore bodies of the value of several millions of dollars. That during said period Sutherland obtained from the financial marts of New York, London, and Paris, and elsewhere, upon the faith and credit of the capital stock of said corporation so issued to him in trust, funds amounting to \$110,000, which were expended by the appellant and Sutherland in developing the properties so held by the corporation. That during said period Sutherland constantly represented to the appellant that the mines were about to be sold, but that he kept the appellant in total ignorance of the manner in which he was obtaining the said funds, and refused to furnish such information. That in the year 1905 Sutherland sent to the appellant for record a deed from said Gilbert of the said property so held by him. That the appellant requested from Sutherland an explanation as to how said purchase had been made and from what source the money had been obtained to pay for the same, but that Sutherland refused to furnish the appellant with such information. That the appellant believes and alleges the fact to be that said money so paid for said properties was money obtained by Sutherland upon the faith and credit of shares of the capital stock of said corporation, and was the property of the copartnership, and alleges that said property was deeded to the said corporation in trust for the appellant and Sutherland. That immediately after the recording of said deed Sutherland proceeded to let contracts for the erection of a mill to work the ore from said mines, and for other work thereon which indicated his intention not to sell or dispose of the same, but to hold and operate the same. That the appellant sought from said Sutherland an explanation of this course of conduct, and Sutherland refused to give the appellant any explanation. That in June, 1905, Sutherland, ignoring the copartnership agreement, and in violation of his promises and agreements, and in an attempt to defraud the appellant of his right, title, and interest in and

to said property, conspired with the board of directors of said corporation, and caused them to pass a resolution removing the appellant as superintendent of said corporation. That prior to June, 1905, the appellant had been led to believe by Sutherland that the property was being promoted and gotten ready for sale in accordance with the original copartnership agreement, but at that time he discovered that the corporation and Sutherland had entered into said conspiracy. That then, thereafter, and ever since said Sutherland has refused to recognize said copartnership, and falsely and fraudulently has claimed and asserted that the appellant has not and never had any interest in said property, and that he is the sole owner of all the capital stock of said corporation, and the property represented thereby. That he has refused to account to the appellant as to any of said property or said stock, or the expenditures or disbursements made by him on behalf of said corporation, or to furnish any information in regard to the same. That on obtaining possession of said mining property Sutherland commenced with great activity to erect a 100-stamp mill thereon, and prepared for working the ores thereof. That during all of said times Sutherland remained out of the jurisdiction of Alaska and of the United States, evading all processes of the courts therein in any action whereby the copartnership interests and ownership of the appellant in said mines could be determined and established. That in July, 1905, the appellant, through his counsel, having theretofore served upon the corporation a copy of the contract and memorandum of partnership, made demand upon said corporation for recognition of the appellant's right as a copartner in and to all the property held by the corporation, and it became evident to said Sutherland and to the corporation that the appellant was about to procure the appointment of a receiver to said mining property, pending the dissolution and winding up of the copartnership, and an accounting thereof. That thereupon said Sutherland and the corporation, for the purpose of preventing such action on the part of the appellant, and for the purpose of permitting Sutherland to come within the jurisdiction of the courts of the United States without being served with process, induced the appellant to meet said Sutherland at Vancouver, B. C., for the alleged purpose of making a settlement, and the appellant, not recognizing that such offer was a trick and artifice to carry out Sutherland's fraudulent scheme, and believing that the proposition was made in good faith, did consent thereto, and sent his counsel to Vancouver, B. C., and that there, in July, 1906, said Sutherland, with the acquiescence of the secretary of said corporation, did enter into a contract in writing with appellant's counsel, whereby Sutherland undertook and agreed, for and on behalf of himself and the corporation, to pay the appellant, in settlement of all his claims, the sum of \$60,000, the first payment to be made December 15, 1906, and the second February 20, 1907, and in said contract it was provided that all pending and contemplated litigation against Sutherland and the corporation by the appellant should be abated. That upon obtaining said contract Sutherland came into the jurisdiction of the United States for the first time since his repudiation of the copartnership, and went to said mines and sought to rush the completion of the mill and begin the milling of ores therein. That thereafter he sought to obtain from the appellant an extension of the time of payment of the money so agreed to be paid on December 15, 1906, and such extension was refused, and on December 16, 1906, the appellant declared a forfeiture of said contract by reason of the breach thereof by Sutherland. That Sutherland, since the exclusion of the appellant from the mining property has caused ore of the value, as the appellant believes, of \$200,000 to be mined and prepared for milling, and is about to mill the same and take the proceeds from the jurisdiction of the court.

The prayer of the bill is: First, that the corporation be required to surrender its subscription book, stock book, and all books and documents by it held, relating to or connected with said property; second, that the court appoint a receiver to take charge of said property and all the property standing in the name of the said corporation, in Alaska; third, that all the stock of the corporation be impounded in the hands of all persons holding the same, pending payment and discharge of the debts upon which the same is hypothecated, and also all stock held or standing in the name of Sutherland, pending the dissolution of the copartnership and the accounting, and that an order be

made directing the corporation to bring into court and surrender to the receiver all the records, books, and documents of said corporation, including its stockbook and subscription books; fourth, that an accounting be had of all debts created by said Sutherland for and on behalf of said properties and now unpaid on said properties; fifth, that an accounting be had between the appellant and Sutherland and the Alaska Perseverance Mining Company, and that the trusteeship of said corporation be annulled and set aside; sixth, that the partnership between appellant and Sutherland be dissolved, and that all remaining property of the same, after the payment of debts, be divided and set aside to the appellant and Sutherland in accordance with the partnership agreement.

The appellees severally demurred to the bill on various grounds, including multifariousness, want of equity, misjoinder of parties defendant, laches apparent on the face of the bill, want of jurisdiction of the Alaska Perseverance Mining Company, and because it appears from the bill that the appellant is estopped, for the reason that the matters complained of are shown to have transpired while he was a director and superintendent of the corporation, and were had with his knowledge, consent, and procurement. By the order of the court each demurrer was "in all things sustained."

G. C. Israel and J. A. Hellenthal (Lorenzo S. B. Sawyer and L. R. Gillette, of counsel), for appellant.

R. F. Laffoon, Maloney & Cobb, Winn & Burton, and Frank M. Stone (W. C. Sharpstein, of counsel), for appellees.

Before GILBERT, ROSS, and MORROW, Circuit Judges.

GILBERT, Circuit Judge (after stating the facts as above). The facts alleged in the bill present a case for equitable relief as against the appellee Sutherland. The formation of the corporation was not necessarily a dissolution of the copartnership. In fact, it is alleged in the bill that the corporation was formed for the purpose of carrying out the copartnership agreement. The case is similar to that of *Monmouth Inv. Co. v. Means*, 151 Fed. 159, 80 C. C. A. 527, in which the court recognized the existence of a copartnership to deal in real estate, aided by a corporation organized merely to be a holding company for the partnership adventures. Nor does it appear from the allegations of the bill that the laches of the appellant are such as to bar his right to equitable relief, or that he is estopped to maintain such a suit. The suit was begun on April 29, 1907. It was not until June, 1905, that the hostile attitude of Sutherland was definitely declared by him. The matter which, by the order of the court, was struck from the bill, contained allegations, which, while they presented no ground of equitable relief, were not wholly foreign to the controversy, for they were in the nature of an excuse for and an explanation of a portion of the delay of the appellant in bringing his suit, and we think they should not have been struck from the bill. But we are of the opinion that the demurrers to the bill were properly sustained for want of jurisdiction of the court to entertain that portion thereof which seeks to take from the Alaska Perseverance Mining Company, a corporation of the state of New York, the possession of its property, books, and records, and place them in the hands of a receiver and impound its stock in the possession of persons holding the same by hypothecation, marshal its assets, and distribute the same by a decree of the court.

It is well settled that, in the absence of a statute enlarging its pow-

ers, a court of equity has no jurisdiction at the suit of a shareholder or other private person to dissolve a corporation. *Thompson on Corp.* pars. 4538, 6598, 6854; *Hardon v. Newton*, 14 Blatchf. 376, Fed. Cas. No. 6,054; *Society for Establishing Manufactures v. Morris Canal Co.*, 1 N. J. Eq. 186, 21 Am. Dec. 41. Nor has a stockholder in a corporation any standing to apply for a receiver to control a corporation or wrest from it its corporate property on the ground that the business of the corporation is managed unwisely or unjustly, and especially is this true of an application for the appointment of a receiver by a resident shareholder, to wind up the affairs of a foreign corporation, notwithstanding that it is doing business within the jurisdiction of the court. *Mining Co. v. Field*, 64 Md. 151, 20 Atl. 1039; *Republican Mountain Silver Mines v. Brown*, 58 Fed. 644, 7 C. C. A. 412, 24 L. R. A. 776; *Leary v. Columbia River & P. S. Nav. Co.* (C. C.) 82 Fed. 775; *Sidway v. Missouri Land & Live Stock Co.* (C. C.) 101 Fed. 481. It is true that the bill in this case does not in terms pray for the dissolution of the corporation, but there can be no question that such is incidentally the effect of placing a corporation in the hands of a receiver. *Sidway v. Missouri Land & Live Stock Co.* (C. C.) 101 Fed. 481. *Monmouth Inv. Co. v. Means*, 151 Fed. 159, 80 C. C. A. 527. In the present case the appellee Sutherland is brought before the court as a defendant, not only in his capacity as copartner with the appellant, but as a director of and the holder in trust of the capital stock of the Alaska Perseverance Mining Company. To such a suit the corporation is a proper party defendant, and the bill is not subject to demurrer for misjoinder of defendants. *Allen v. Curtis*, 26 Conn. 456; *Sears v. Hotchkiss*, 25 Conn. 171, 65 Am. Dec. 557; *Hersey v. Veazie*, 24 Me. 9, 41 Am. Dec. 364; *Brewer v. Boston Theater*, 104 Mass. 378; *Dodge v. Woolsey*, 18 How. 331, 15 L. Ed. 401; *March v. Eastern R. Co.*, 40 N. H. 548, 77 Am. Dec. 732.

Inasmuch as the demurrers were sustained on all the grounds therein set forth, it is proper, while affirming the ruling of the court below on the demurrer to the bill as it stands, to direct that the cause be remanded to that court, with permission to the appellant to amend, if he so elects. It is so ordered.

CITIZENS' BANK OF DOUGLAS, GA., v. HARGRAVES.

(Circuit Court of Appeals, Fifth Circuit. November 10, 1908.)

No. 1,760.

BANKRUPTCY (§ 399*)—EXEMPTIONS—WAIVER—GEORGIA STATUTE.

Under the provisions of the Constitution and statutes of Georgia relating to exemptions, which authorize a debtor to waive in writing his right of exemption "except as to wearing apparel and not exceeding three hundred dollars worth of household and kitchen furniture and provisions," such exception is confined to specific articles; and, where a bankrupt had given a note secured by a chattel mortgage on property not within the exception, in which note he waived his right of exemption, he is not entitled, as against the mortgagee, to an exemption of \$300 from the

*For other cases see same topic & § NUMBER in Dec. & Am. Digs. 1907 to date, & Rep'r Indexes

proceeds of the mortgaged property sold by the trustee by consent of all parties.

[Ed. Note.—For other cases, see Bankruptcy, Cent. Dig. §§ 664-669; Dec. Dig. § 399.*]

Petition to Superintend and Revise Proceedings from the District Court of the United States for the Southern District of Georgia.

W. W. Lambdin (Wilson, Bennett & Lambdin and Lankford & Dickerson, on the brief), for petitioner.

Benjamin G. Parks, for respondent.

Before PARDEE and SHELBY, Circuit Judges, and BURNS, District Judge.

SHELBY, Circuit Judge. This petition involves a bankrupt's claim to exemptions. The court below ordered \$300 to be set apart to the bankrupt from the proceeds of the sale of mortgaged property to which the right of exemptions had been waived, and the petitioner seeks to revise and reverse the order. To make plain the question to be decided, the facts and the Georgia exemption laws must be briefly stated.

Hargraves, the respondent, on January 2, 1907, for value, made and delivered to the Citizens' Bank, the petitioner, his note for \$871.69. The note contains in due form a stipulation waiving the maker's right to exemptions. At the same time, Hargraves executed and delivered to the bank a mortgage on four mules to secure the payment of the note. The mortgage contains a clause whereby the mortgagor does "solemnly waive and renounce * * * all right of homestead or exemption in and to all the property hereby conveyed, and does covenant and agree not to take, nor consent to the taking * * * of, any homestead or exemption now allowed by law or which may hereafter be allowed against the debt aforesaid." More than four months later, Hargraves filed his voluntary petition in bankruptcy in the court below, and was adjudicated a bankrupt. The mules covered by the mortgage (with other property not involved in this case) were sold by the trustee under an order made by the referee. The order was made by consent, all parties in interest agreeing that the property should be sold free of all liens, and that the proceeds of sale should be subject to all just claims and liens that existed on the property. The four mules sold for \$468. The bankrupt's claim for exemptions coming on first to be heard before the referee, he ordered "that the bankrupt's right to an exemption in so much of the fund arising from the sale of the property covered by the mortgage of the Citizens' Bank of Douglas be and the same is hereby denied and refused." This order being under review in the District Court, that court decreed that "the order of the referee refusing exemption to the bankrupt be modified, and that the prayer of the bankrupt in his petition asking that he be given the sum of \$300 in cash, as allowed under the Constitution and laws of Georgia, is hereby granted." Construing the decree of the District Court in the light of the order of the referee which the

*For other cases see same topic & § NUMBER in Dec. & Am. Digs. 1907 to date, & Rep'r Indexes

court was modifying, it appears that the court decreed, notwithstanding the stipulations waiving exemptions, that the claim for an exemption of \$300 should prevail over the mortgagee's claim for the \$468, the proceeds of the sale of the mortgaged property. The question to be decided, therefore, is whether, on the facts, the mortgagee and creditor is entitled to all the money paid for the mortgaged mules, it being less than the debt due him, or is the mortgagor and debtor entitled to \$300 of the money as exempt? The answer, of course, depends on the exemption laws of Georgia.

For convenience of reference, the relevant sections of the Georgia Constitution and statutes relating to the waiver of exemptions will be copied in a note. It may be briefly stated that there are two kinds of homesteads or exemptions recognized, the constitutional and the statutory. The former consists of realty or personalty, or both, to the value of \$1,600 (Civ. Code Ga. 1895, § 5912); the latter consists of 50 acres of land, and 5 additional acres for each child, one farm horse or mule, and other articles enumerated in the statute. *Id.* § 2866. The Constitution and statutes, with an exception to be hereinafter noted, expressly provide that the debtor shall have the power to waive or renounce his right of exemptions. This right "to waive" appears in several sections, and is applicable to all exemptions, with the exception, which is also repeated. It is clear, therefore, that the power exists in a debtor, subject to the exception noted, to waive the right of exemption in favor of a creditor. *Broach v. Powell, Executor, et al.*, 79 Ga. 79, 81, 3 S. E. 763. The exception is that the waiver shall not "extend to wearing apparel, and not exceeding three hundred dollars worth of household and kitchen furniture and provisions." Civ. Code Ga. 1895, §§ 2863, 5914, 5916. The exception, excluding the power to waive, relates to named articles or property. The waiver of exemption is good by express law, except as to the property described and excepted. Mules not being included in the exception, the power to waive the right of exemption as to them clearly existed. It is not difficult to see that if the mortgage and contract of waiver, instead of embracing mules, had covered wearing apparel, household and kitchen furniture, and provisions, property excepted from the power of renouncement or waiver, the proceeds of the sale of such property, sold under the agreement stated, would have been subject, so far as the waiver was concerned, to the claim of exemptions. The waiver in that case would have been inoperative. But there is no rule of construction or mode of reasoning that will recognize the unquestioned power to waive the right of exemptions as to mules, and yet treat the purchase money arising from the sale of the mules as wearing apparel, household and kitchen furniture, and provisions, for the purpose of applying the exception of the Constitution and the statute.

The petition for revision is allowed, the decree of the District Court modifying the order of the referee is reversed, and the cause remanded, with instructions to enter a decree confirming the order of the referee of date, August 30, 1907, that the bankrupt's right to an exemption in so much of the fund as arises from the sale of the prop-

erty covered by the mortgage to the Citizens' Bank of Douglas, be denied and refused.

Petition to revise allowed.

NOTE. The following sections are found in the Constitution of Georgia, as they appear in the Georgia Code of 1895:

"Section 3.

"§ 5914. (5212). Paragraph 1. May be waived, how far; how sold. The debtor shall have power to waive or renounce in writing his right to the benefit of the exemption provided for in this article, except as to wearing apparel, and not exceeding three hundred dollars worth of household and kitchen furniture, and provisions, to be selected by himself and his wife, if any, and he shall not, after it is set apart, alienate or encumber the property so exempted, but it may be sold by the debtor and his wife, if any, jointly, with the sanction of the judge of the superior court of the county where the debtor resides or the land is situated, the proceeds to be reinvested upon the same uses.

"Section 4.

"§ 5915. (5213). Paragraph 1. Setting apart short homestead. The General Assembly shall provide, by law, as early as practicable, for the setting apart and valuation of said property. But nothing in this article shall be construed to affect or repeal the existing laws for exemption of property from sale, contained in the present Code of this state in paragraphs 2040 to 2049, inclusive, and the acts amendatory thereto. It may be optional with the applicant to take either, but not both, of such exemptions.

"Section 5.

"§ 5916. (5214). Paragraph 1. Short homestead may be waived. The debtor shall have authority to waive or renounce in writing his right to the benefit of the exemption provided for in section four, except as is excepted in section three of this article."

The following is the statutory provision relating to the same subject, now a part of the Georgia Code of 1895:

"§ 2863. (2039a). Debtor may waive exemption. Any debtor may, except as to wearing apparel and three hundred dollars worth of household and kitchen furniture, and provisions, waive or renounce his right to the benefit of the exemption provided for by the Constitution and laws of this state, by a waiver, either general or specific, in writing, simply stating that he does so waive or renounce such right, which waiver may be stated in the contract of indebtedness, or contemporaneously therewith or subsequently thereto in a separate paper."

TAYLOR v. ADAMS EXPRESS CO.

(Circuit Court of Appeals, Third Circuit. October 12, 1908.)

COURTS (§ 356*)—FEDERAL COURTS—PROSECUTION IN FORMA PAUPERIS—PROCEDURE.

Act July 20, 1892, c. 209, 27 Stat. 252 (U. S. Comp. St. 1901, p. 706), which allows the prosecution of an action in forma pauperis in a federal court, does not apply to appellate proceedings, and in the absence of a statute authorizing it the Circuit Court of Appeals has no authority to allow an appeal or writ of error in that form.

[Ed. Note.—For other cases, see Courts, Dec. Dig. § 356*; Appeal and Error, Cent. Dig. § 2072.]

Petition for Leave to Prosecute a Writ of Error in Forma Pauperis.

*For other cases see same topic & § NUMBER in Dec. & Am. Digs. 1907 to date, & Rep'r Indexes

Wain & Ellis, for petition.

PER CURIAM. It was expressly decided by the Supreme Court in *Bradford v. Southern Railway*, 195 U. S. 243, 25 Sup. Ct. 55, 49 L. Ed. 178, that Act July 20, 1892, c. 209, 27 Stat. 252 (U. S. Comp. St. 1901, p. 706), which allows the prosecution of an action in forma pauperis, does not apply to appellate proceedings, and that the Circuit Court of Appeals have no authority to allow an appeal or writ of error in that form, in the absence of a statute.

This is conclusive of the question, and the petition is therefore denied.

PARSONS NON-SKID CO., Limited, et al. v. VICTOR TIRE GRIP CO.

(Circuit Court, D. New Hampshire. October 22, 1908.)

No. 365.

1. PATENTS (§ 298*)—SUIT FOR INFRINGEMENT—PRELIMINARY INJUNCTION.

Unless a patent is supported by public acquiescence, or prior adjudication, or some other peculiar condition, the complainant's rights must be free from doubt to entitle him to a preliminary injunction.

[Ed. Note.—For other cases, see Patents, Cent. Dig. §§ 474-478; Dec. Dig. § 298.*

Grounds for denial of preliminary injunctions in patent infringement suits, see note to *Johnson v. Foos Mfg. Co.*, 72 C. C. A. 123.]

2. PATENTS (§ 328*)—ARMOR FOR PNEUMATIC TIRES.

The Parsons patent, No. 723,299, for an armor for pneumatic tires, the validity of which had not been adjudicated, *held* not so clearly valid or supported by general acquiescence as to warrant the granting of a preliminary injunction against an alleged infringer.

[Ed. Note.—For other cases, see Patents, Dec. Dig. § 328.*]

In Equity. On motion for preliminary injunction.

H. P. Denison, for complainants.

Emery & Booth (Lawrence A. Janney, of counsel), for defendant.

HALE, District Judge. In this cause in equity the bill alleges infringement of letters patent No. 723,299, dated March 24, 1903, issued to Harry Parsons for an armor for pneumatic tires. The armor consists of chains to be placed on the wheels of automobiles to prevent skidding. The case now comes before the court upon motion for a preliminary injunction.

The courts of this circuit have been somewhat strict in applying the law in reference to this class of cases. There must in every instance be an equitable necessity for injunctive relief. Our Court of Appeals has held that:

"Unless the patent is supported by public acquiescence, or prior adjudication, or some other peculiar condition, the complainant's rights must be free from doubt to entitle him to a preliminary injunction." *Wilson v. Consolidated Store Service Co.*, 88 Fed. 286, 287, 31 C. C. A. 533; *Hatch Storage Bat-*

*For other cases see same topic & § NUMBER in Dec. & Am. Digs. 1907 to date, & Rep'r Indexes

tery Co. v. Electric Storage Battery Co., 100 Fed. 975, 41 C. C. A. 133; Bresnahan v. Tripp Giant Leveler Co., 72 Fed. 920, 19 C. C. A. 237.

1. It is clear that the patent has not been sustained by prior adjudication on final hearing after a "bona fide and strenuous contest."

2. Is the validity of the patent clear?

Upon this point an examination of the prior art raises some serious and interesting questions which have been argued in briefs of great length and elaboration by counsel on either side, and have engaged the careful attention of the court. This fact is, in itself, a suggestion that justice would not be done by passing upon the matter of injunctive relief, except upon final hearing and upon full proofs. It has come to be the unquestioned doctrine that courts will not anticipate a trial upon the merits by an extended examination of the testimony. In cases involving disputed questions of fact, courts will refuse a preliminary injunction until those matters are presented for investigation in their proper order and in their final form. *Robinson on Patents*, § 1173.

In *Wilson v. Consolidated Store Service Company*, supra, Judge Putnam has referred to a line of cases upon this point.

It is not necessary to discuss here the matters in controversy with reference to the prior art. Any observations upon these controverted matters might be prejudicial to the future consideration of the case. I am forced to find that the complainant's rights are not free from doubt.

3. Has there been sufficient public acquiescence?

The courts have pointed out with reference to public acquiescence that there must be the same freedom from doubt in behalf of the party applying for a preliminary injunction as if the question were one of validity alone. After a full examination of the testimony upon this point, I am not satisfied that, during the life of the patent, there has been that genuine and general acquiescence in it which is sufficient to justify the court in granting injunctive relief.

A preliminary injunction is denied.

PRESCOTT v. GALLUCCIO et al.

(District Court, N. D. New York. October 19, 1908.)

1. BANKRUPTCY (§ 178*)—FRAUDULENT TRANSFER OF PROPERTY—RECOVERY BY TRUSTEE.

A bankrupt, some six months before his bankruptcy, executed to his wife without consideration a deed to real estate which had been paid for in part from the proceeds of a boarding house conducted by his wife, but not as a separate business, and in part with other money of his. Prior to such conveyance he had made statements for the purpose of obtaining credit in which he represented that he was the owner of the property. Shortly after such deed he sold the property, and he and his wife joined in making a deed thereto to the purchaser, who gave back a mortgage for a part of the purchase money to the wife. The deed to her, however, was not delivered until it was recorded by the bankrupt a few days prior to his bankruptcy, and when insolvent, and in the meantime he had largely increased his indebtedness, and both he and his wife stated to his

*For other cases see same topic & § NUMBER in Dec. & Am. Digs. 1907 to date, & Rep'r Indexes

creditors that she had no property, but all the property was his. *Held*, under the evidence, that the deed to the wife was made with intent to defraud both present and subsequent creditors, and was void as to both classes; that it gave the wife no right to the mortgage taken in her name, which was the property of the bankrupt, and recoverable by the trustee, under Bankr. Act July 1, 1898, c. 541, § 70e, 30 Stat. 566 (U. S. Comp. St. 1901, p. 3452), the purchaser of the property having bought in good faith.

[Ed. Note.—For other cases, see Bankruptcy, Cent. Dig. §§ 273, 274; Dec. Dig. § 178.*]

2. BANKRUPTCY (§ 302*)—SUIT BY TRUSTEE—PLEADING.

A bill by a trustee in bankruptcy to recover property fraudulently conveyed by the bankrupt, under Bankr. Act July 1, 1898, c. 541, § 70e, 30 Stat. 566 (U. S. Comp. St. 1901, p. 3452), should allege that the property of the bankrupt is insufficient to pay his debts in full; but where no objection is made on that ground, and the proof shows such fact, the omission may be supplied by amendment.

[Ed. Note.—For other cases, see Bankruptcy, Dec. Dig. § 302.*]

In Equity. Suit by trustee to set aside certain deeds or transfers of real estate and recover same, or proceeds thereof, for benefit of estate.

G. L. Prescott, for plaintiff.

D. F. Searle, for defendants Galluccio.

RAY, District Judge. August 16, 1906, John Galluccio filed his petition and schedules in voluntary bankruptcy. August 17, 1906, he was adjudicated a bankrupt accordingly. August 31, 1906, the plaintiff was duly appointed trustee in bankruptcy, and September 4, 1906, he duly qualified as such. April 29, 1902, Minnie A. O'Neil, in consideration of the sum of \$1,000, deeded to John Galluccio the lands and premises in question, situate in the city of Rome, Oneida County, N. Y., where Galluccio and Angelina Galluccio his wife then resided. This deed was duly recorded in Oneida county clerk's office May 6, 1902, in Liber 576 of Deeds, at page 68. The title stood in the name of said John Galluccio under this deed until December 20, 1905, some three years and eight months, when John Galluccio deeded same to Angelina Galluccio, his wife, for the recited consideration of \$100. This deed was not recorded until the 10th day of August, 1906, when it was recorded in Oneida county clerk's office in Book 603 of Deeds, at page 247. March 12, 1906, said John Galluccio and Angelina Galluccio, his wife, executed a deed of the said premises to Raffaele Dolende and Stella Dolende, of Rome, N. Y., in consideration of \$1,260; they giving back a mortgage to secure the payment of \$1,060 of the purchase price. This deed was recorded March 16, 1906 in Book of Deeds 615, page 332, and the mortgage was recorded the same day in Liber 425 of Mortgages, page 498.

On and prior to August 15, 1906, John Galluccio owed the firm of Marone & Lofaro, of Utica, N. Y., about \$700. The last of July, 1906, he owed the firm \$400, and, having been asked for pay, he went to Mr. Marone, one of the firm, and gave him a check for something over \$300 on account, and purchased more goods on credit. The

*For other cases see same topic & § NUMBER in Dec. & Am. Digs. 1907 to date, & Rep'r Indexes

check was duly presented and not paid; Galluccio having no funds. It was never paid, nor was the new indebtedness. Early in August Marone went to Rome, and saw Galluccio and his wife, and asked for pay; asked for a note with the indorsement of the wife. The wife declined to sign a note, and stated as the reason she had nothing, no property, no personal property or real estate, no interest in any property; that everything was in the name of Mr. Galluccio. She stated the same to Mr. Grant, who was present. Mr. Marone then said he would rely on that and on Galluccio's promise. Soon after Galluccio went into bankruptcy, and the wife claims the mortgage as hers. In 1905, when Marone commenced extending this credit to Galluccio, Galluccio stated to him that he owned property, real and personal, and Marone relied on that statement in extending the credit; but he did not inquire as to the particulars, or what particular property he owned. Marone did not learn of the transfer of this property from Galluccio to his wife, and then to Dolende, until after the bankruptcy. Early in August, 1906, John H. Grant went with Mr. Marone to see Galluccio, and saw him and his wife at Galluccio's place of business. At that time and place both Galluccio and his wife stated to Grant and Marone that the wife had no property, and that everything belonged to Galluccio. When John Galluccio and Angelina Galluccio deeded the property to the Dolendes, they paid down \$200, paying \$1,260 for the property. The \$200 was paid by turning over bank books to John Galluccio, and he got the money. At the time of the trial there was unpaid of the principal on the mortgage \$760.

In December, 1905, John Galluccio made application to Armour & Co., at Rome, N. Y., for credit; said application being made to Allen T. Humphrey, the agent of said company. Mr. Humphrey drew up an application for credit, and inquired of Galluccio what property he had, and Galluccio answered, and stated that he owned real property worth \$1,200, and also property he had bought of one A. Frank, and stated it was free from incumbrance. Humphrey ascertained it was this property in question. The representations were reported to Armour & Co., and on the strength of such representations credit was given by that company to John Galluccio. He had not then deeded the property to his wife. Other credit was given on the strength of the same representations thereafter, and before the deed to Angelina Galluccio was recorded or the transfer to her became known. At the time the property was purchased and John Galluccio took the deed \$500 was borrowed of one Ellis to pay a part of the purchase money, and a mortgage was given, executed by both John and his wife, necessarily and properly to cut off the dower interest of the wife. That was subsequently paid by John Galluccio, and, I find, with his money. Both John Galluccio and Angelina, his wife, deny the representations and statements alleged and above referred to; but I am fully satisfied they were made, and that credit was given on the strength of them and the apparent ownership of the property by John Galluccio. The wife now claims that she paid in most of the money for the place, that it should have been deeded to her, that when she discovered the deed was to her husband they quarreled over the matter, and that as a result he deeded it over to her, because it was hers in fact and was to

have been deeded to her. There is no evidence to sustain such a claim, except the testimony of John Galluccio and that of his wife. They claim they kept roomers and boarders, and in this way she earned the money; but her services belonged to the husband. It is said she paid for groceries at the store; but it also appears that the husband furnished her money for this purpose.

On a careful perusal of the evidence I am convinced that the representations and statements set forth were made by both husband and wife; that they were made for the purpose of obtaining credit and keeping off creditors, and acquiesced in by the wife; that she represented and admitted she had no property, but that everything belonged to her husband; that in fact the property was purchased by the husband, that his money paid for it, that he was the owner, and that the transfer was made to the wife when he was in debt and obtaining credit, and that the deed was purposely kept from the records; that he did obtain credit both before and after the deed to the wife on the strength of his statements and apparent ownership; and that the transfer was made to the wife and received by her for the purpose of cheating and defrauding his creditors. So far as Raffaele Dolende and Stella Dolende are concerned there was no fraud or bad faith. They purchased in good faith and for a valuable consideration, and gave the mortgage referred to to secure the payment of a part of the purchase price, most of it. That mortgage was given to the defendant Angelina Galluccio, and some \$700 is unpaid thereon. She still has it. With it in her possession she denied that she had any property, and stated that everything belonged to her husband John Galluccio. The claims of these creditors against Galluccio have been proved and allowed. These claims existed in part when the illegal and fraudulent transfer was made by John Galluccio to his wife, Angelina Galluccio. Angelina Galluccio has no moral right to that mortgage, or the moneys due or unpaid thereon, as against the creditors of John Galluccio. There is no allegation or proof that John Galluccio was insolvent at the time the deed to his wife was executed. He was insolvent at the time it was recorded. The schedules of the bankrupt show that his estate was and is insufficient to pay his debts existing at the time of the filing of the petition in bankruptcy. This fact is not alleged in the bill of complaint; but no objection on that ground was raised during the trial or on motion to dismiss. No demurrer was interposed. There is no evidence that the deed from Galluccio to his wife was ever delivered to her, except from the fact that John Galluccio, at about the time it was recorded, sent it to the clerk's office for record. He says:

"Q. When did you find out that the deed ought to be recorded? A. The time when I failed, and I brought all my papers to Mr. Searle, and he looked over the papers, and he saw that deed over there, and he said, 'Why don't you send that deed to Utica?' and I told him I didn't know anything about it, and he sent it."

I do not think the evidence shows a delivery of the deed to Mrs. Galluccio until the date of record. There was no adequate consideration for the transfer from Galluccio to his wife. It seems to me that the money earned in keeping boarders belonged to the husband. The

services of the wife belonged to the husband. The premises where they lived and kept roomers and boarders did not belong to the wife. She was not running the business as her own independent business. There is no pretense the wife had property from any other source. If she paid some of the board and rent money for groceries used to run the table, that fact did not make all the earnings or savings hers. But it appears conclusively that the husband furnished part of the money for that purpose, and it is conceded he had several hundred dollars in this real estate aside from this board and rent money. From the evidence before me it appears that John Galluccio ran up over \$3,000 indebtedness between January, 1906, and the time he filed his petition in bankruptcy, none of which has been paid; that December 28, 1905, he executed this deed to his wife, and so far as appears retained it in his own possession, and it was not of record. Shortly before he failed and filed his petition he and his wife made statements as hereinbefore set forth. Evidently they did not take into consideration the mortgage, or consider the effect of their admissions so far as that was concerned. Probably they thought the bankruptcy proceedings would end the whole matter, and had no idea the mortgage could be reached. I think that, from what Galluccio and his wife did and the statements and admissions they made, the inference is inevitable that they intended to put the real estate in the wife's name, that he should run up a large indebtedness, and then go into bankruptcy. I am of opinion that there was an intent on the part of John Galluccio, grantor, and Angelina Galluccio, his wife, grantee, to transfer the property to her for the purpose of hindering, delaying, and defrauding his creditors, those then existing and those that might exist. I think the deed was kept from record for the purpose of carrying out the intent, that in fact the wife never had the deed, that there was no delivery until it was recorded August 10, 1906, and that there was no adequate consideration therefor.

As to the Dolendes there is no evidence of fraud or deceit. They took title from both John and Angelina Galluccio, and paid full consideration in cash and by giving the mortgage mentioned. That mortgage to the extent of some \$700 Mrs. Galluccio has; but in equity it belonged to John Galluccio when he filed his petition in bankruptcy, and now belongs to his trustee in bankruptcy. The bill of complaint may be amended, so as to allege that Galluccio owed debts in excess of his assets, etc. There will be a decree that the mortgage belongs to the trustee in bankruptcy, and that he may recover same, and all sums due or to grow due thereon, and that Angelina Galluccio shall assign and deliver same to the trustee, and also enjoining and restraining the Dolendes from making any further payments thereon to Angelina Galluccio, and directing that payments shall be made to the trustee. I do not think the action has entailed any great hardships on the Dolendes. They were necessary parties. It was impossible to tell in advance just what the evidence would disclose.

This disposition of the case is fully warranted under the bankruptcy act (Act July 1, 1898, c. 541, subd. E, § 70, 30 Stat. 566 [U. S. Comp. St. 1901, p. 3452]) and the decisions (*Mueller v. Bruss*, 8 Am. Bankr. Rep. 442, 112 Wis. 406, 88 N. W. 229; *Sheldon v. Parker*, 11

Am. Bankr. Rep. 152, 66 Neb. 610, 92 N. W. 923, 95 N. W. 1015; *Beasley v. Coggins*, 12 Am. Bankr. Rep. 355, 48 Fla. 215, 37 South. 213; *In re Yukon Woolen Co. (D. C.)* 2 Am. Bankr. Rep. 805, 96 Fed. 326; *In re McNamara*, 2 Am. Bankr. Rep. 566; *In re Rodgers*, 11 Am. Bankr. Rep. 79, 125 Fed. 169, 60 C. C. A. 567; *In re Butterwick [D. C.]* 12 Am. Bankr. Rep. 536, 131 Fed. 371; *Collier on Bankruptcy* [6th Ed.] 591, 612; *Baldwin v. Short*, 125 N. Y. 553, 559, 560, 26 N. E. 928; *Billings v. Russell*, 101 N. Y. 226, 4 N. E. 531; *Dewey v. Moyer*, 72 N. Y. 70). See, also, *Parker v. Black (D. C.)* 16 Am. Bankr. Rep. 202, 143 Fed. 560; *Off v. Hakes*, 15 Am. Bankr. Rep. 697, 142 Fed. 364, 73 C. C. A. 464; *Pond v. N. Y. Exc. Bank (D. C.)* 10 Am. Bankr. Rep. 343, 124 Fed. 992; *Lawrence v. Lowrie (D. C.)* 13 Am. Bankr. Rep. 297, 133 Fed. 995.

This is not the case of a preference, but subdivision "e" of section 70 of the act is explicit that the action may be maintained by the trustee, and the cases hold that a judgment by the creditor or trustee is not necessary. When there is no adequate consideration for the transfer, or when there is intent to cheat, defraud, hinder, or delay, the action may be maintained. It must appear that the property of the bankrupt is not sufficient to pay his creditors in full. This should be alleged, and there will be an amendment accordingly. The proof is in the case, and courts will not disregard the merits on a technicality or error in pleading, when the evidence is before them.

While here we find antecedent creditors, the general rule which controls the decision of this case, supported by the numerous cases cited, is thus stated in 20 Cyc. 423:

"(c) Subsequent Creditors. (1) General Rule. The general rule is that a voluntary conveyance cannot be set aside at the instance of subsequent creditors, in the absence of proof that the conveyance was made with actual fraudulent intent. Where, however, a conveyance is made with the intent to defraud subsequent creditors, or there was secrecy in the transaction by which knowledge of it was withheld from such creditors, who dealt with the grantor upon the faith of his owning the property transferred, or the transfer was made with a view of entering into some new and hazardous business, the risk of which the grantor intended should be cast upon the parties having dealings with him in the new business, such conveyance is fraudulent as to subsequent creditors, and may be attacked by them. However, a mere expectation of future indebtedness, or even an intent to contract debts, if it be only an intent, not coupled with a purpose to convey the property in order to keep it from being reached by the creditors, will not make the deed invalid as against such future creditors."

LACEY et al. v. THOMAS.

(Circuit Court, D. Oregon. October 12, 1903.)

No. 3,143.

1. BROKERS (§ 10*) — EMPLOYMENT AND AUTHORITY — REVOCATION BY AGREEMENT.

Defendant signed a contract, reciting a sufficient consideration, by which he authorized plaintiffs as his agents to sell a tract of land for a stated price and to execute a binding contract in that behalf. Afterward defendant wrote plaintiffs that his wife refused to sign the deed for such

*For other cases see same topic & § NUMBER in Dec. & Am. Digs. 1907 to date, & Rep'r Indexes

price and stating that they might as well take the land off the market. To this plaintiffs replied, in effect assenting, and asking for defendant's lowest price for the land, and stating, "When we hear from you we will say what we can do." *Held*, that by such letters the agency contract was entirely abrogated, leaving the matter at large for new negotiations between the parties.

[Ed. Note.—For other cases, see *Brokers*, Dec. Dig. § 10.*]

2. VENDOR AND PURCHASER (§ 16*) — REQUISITES OF CONTRACT — ACCEPTANCE VARYING FROM OFFER.

Defendant, who was the owner of a tract of land, in answer to a letter from plaintiffs, who resided at a distance, asking for his lowest price for the land and that he give them a 10-day option to purchase, wrote that he would take "\$5,000 cash, but no less," and stating, "If you want the place at that price you can have it any time; that is \$5,000 clear." To this plaintiffs replied that they would accept the offer, and directing defendant to make out a deed, leaving blanks for the name of the grantee and the consideration, and to send the same, together with abstract of title, to a bank named at plaintiffs' place of residence, "to be turned over to us upon payment of \$5,000." *Held* that, under the rule that an acceptance of an offer must be identical with the offer and unconditional, the letter of plaintiffs was not an acceptance which made a contract binding on defendant, in that the offer was to sell to plaintiffs, and not to some third party unknown, and the letter proposed to make the payment to a distant bank, and not to defendant at his place of residence, and also required him to furnish an abstract, in all of which respects there was a substantial variance between the offer and the acceptance.

[Ed. Note.—For other cases, see *Vendor and Purchaser*, Cent. Dig. §§ 17, 18; Dec. Dig. § 16.*]

At Law:

This is an action for the recovery of damages for breach of an alleged contract for sale of a tract of real property, which has been submitted to the court without the intervention of a jury. By stipulation of the parties relative to the evidence pertinent to the cause, it appears that plaintiffs are partners, doing business under the firm name of James D. Lacey & Co., and citizens and inhabitants of the state of Illinois, and that the defendant is a resident and citizen of the state of Oregon; that on January 28, 1907, the defendant, being the owner of the N. W. $\frac{1}{4}$ of section 36, township 8 S., range 9 W. of the Willamette meridian, in Lincoln county, Or., executed at Junction City, Or., to the firm of McClintock & Lacey, a certain paper, designated as "Agents' Authority to Sell," which, so far as material, reads as follows:

"To McClintock & Lacey: In consideration of valuable services performed and to be performed by you, I hereby give you exclusive authority to sell for me the following property: [Describing the land in question]—at any time within 60 days from the date hereof and until notified in writing, at the price of \$4,000.00 (four thousand dollars) on the following terms: For cash. You are hereby authorized to accept a deposit, to be applied on the purchase price, and execute a binding contract of sale on my behalf, on making sale within the time above specified; and I bind myself and my heirs to make the purchaser a good and sufficient deed for the same."

On March 4, 1907, from Junction City, Or., the defendant wrote McClintock & Lacey at Portland, as follows:

"Some time in Jan. I let you have the selling of the N. W. $\frac{1}{4}$ of Sec. 36, T. 8, R. 9 W., in the Siletz. Since I told my wife about it, there has been no peace in the family. She says she positively will not sign the deed, so you might just as well take it off the market. She thinks I am letting it go too cheap. Will let you hear from me again if I can get her to change her mind. But at present there is no use to try to make a sale."

On the 14th of the same month McClintock & Lacey wrote the defendant in reply:

*For other cases see same topic & § NUMBER in Dec. & Am. Digs. 1907 to date, & Rep'r Indexes

"Your letter received. Sorry to hear that Mrs. Thomas does not approve of the sale of your claim. Well, we won't kick. However, we would like to have your lowest cash price. Ask Mrs. Thomas what she will sign a deed for, and send us a ten-day option for the claim at that price. We have gone to the trouble of looking it, and would like to have a show, and at the same time we are willing to do the right thing by you. All we have asked at any time was your price. When we hear from you, we will say what we can do."

On March 18th defendant wrote McClintock & Lacey again, this time from Roseburg:

"Your letter of the 14th received. My wife says she will sell for \$5,000 cash, but no less. I am not in the timber business and was not posted on prices, and after looking the matter over I think myself that \$5,000 is dirt cheap for a claim of this kind, as it is one of the best in the Siletz Mountains. I got notice from the land office in Portland that my patent is there, so if any one wants to buy at that price they can get a good title. So if you want the place at that price, you can have it any time; that is, \$5,000 clear."

On March 20th McClintock & Lacey replied:

"Your letter of the 18th inst. received. In reply will say that we will accept your offer, and you can make out your deed and send it, together with your patent and abstract, to the Bankers' & Lumbermen's Bank of this city, to be turned over to us upon payment of \$5,000. You will be able to get an abstract of title from C. B. Crosno, Toledo, Or. Leave the grantee's name and consideration in the deed blank, so we can fill it in later. Please acknowledge receipt of this and let us know when you will have the papers here."

Without further correspondence with McClintock & Lacey, and on the 25th of March, 1907, the defendant and his wife sold the land to one R. E. Williams. On April 18, 1907, plaintiffs purchased of Williams for a consideration of \$9,000. At all the times involved by these transactions McClintock & Lacey were agents of the plaintiffs, and the alleged contract was entered into by McClintock & Lacey for and in behalf of the plaintiffs. The amount of damages prayed for is \$4,000, being the difference between the alleged purchase price agreed upon, namely, \$5,000, and the amount which the plaintiffs were obliged to pay to Williams for the land in order to get the title.

Platt & Platt, for plaintiffs.
J. N. Brown, for defendant.

WOLVERTON, District Judge (after stating the facts as above). The crucial question involved by the controversy is whether there was a completed or consummated contract entered into between the parties for the sale by the defendant to the plaintiffs of the tract of land mentioned. In the view I take of the case it may be conceded that McClintock & Lacey were the agents of the plaintiffs, and acted for them in that relation in every step taken looking to the consummation of the alleged contract. So we may lay aside any question of agency, except to remark the real character of the instrument denominated "Agents' Authority to Sell."

Without more—that is, independent of further correspondence or negotiations between the parties—this paper must be considered to have constituted a completed agents' contract, authorizing the sale of the land in behalf of the defendant and the execution of a binding contract to that end. Furthermore, the contract having recited that valuable services had been and were to be performed by the agents, there was consideration sufficient, prima facie, to support it. The recitation is tantamount to an admission in the writing to that effect, concluding the parties, until rebutted by competent and sufficient proof to the contrary. 6 Am. & Eng. Enc. of Law, 765. The effect, however,

of the two letters immediately succeeding the execution of this contract was to abrogate it entirely; the reason inducing the abrogation being the refusal of the defendant's wife to sign a deed of conveyance upon the terms specified. Following upon the reason assigned, the defendant directed the agents that there was no use to try to make a sale, to which they assented; their language being, "We won't kick." The expression is forcible, and not to be misunderstood, however inelegant it may be considered. The agents then requested the defendant to give them the lowest price he and his wife would be willing to accept as an inducement to sign a deed for the property, and to give them a 10-day option to purchase at the price named. In closing their letter they say: "When we hear from you we will say what we can do."

The effect of these letters is persuasive and convincing that the indentment of the parties was to set the entire matter at large again, and to open new negotiations looking to concluding another and different and distinct contract, if they were able so to agree. McClintock & Lacey's letter, consenting to a revocation of the agents' contract, opened the way for a new proposal from the defendant, and another and a new agreement. Responding, therefore, to their inquiry, the defendant proposed to sell for "\$5,000 cash, but no less," and concluded by saying: "So, if you want the place at that price, you can have it any time." In brief, to bring the negotiations in close relation, the agents requested of the defendant that he and his wife should fix a price that they would be willing to take for the land, and to send them a 10-day option to purchase, promising that they would say what they could do when they heard from him. To this letter the defendant replied, four days later, proposing to take \$5,000 cash for the place at any time. These are the terms of proposal of substance coming from either way, and at this juncture it is clear that there was yet no agreement, no final meeting of the minds of the parties, and hence no completed contract. Two days later, and probably in due course of return mail from Portland to Junction City, the agents replied:

"We will accept your offer, and you can make out your deed and send it, together with your patent and abstract, to the Bankers' & Lumbermen's Bank of this city, to be turned over to us upon payment of \$5,000. You will be able to get an abstract of title from C. B. Crosno, Toledo, Or. Leave the grantee's name and consideration in the deed blank, so we can fill it in later."

To this there was no further answer on the part of the defendant, and the inquiry is whether these later negotiations resulted in a completed and binding contract between the parties. There was no assent whatever by defendant to McClintock & Lacey's proposal to take a 10-day option for the claim, and the entire contract, if one subsists at all at the end of all negotiations, depends upon the last offer of the defendant and the legal consequence and effect of McClintock & Lacey's rejoinder thereto. Whether the contract was concluded depends upon this inquiry: Was the rejoinder an unconditional acceptance of the substantial terms of defendant's proposal? The unvarying rule is thus stated:

"An acceptance, to be effectual, must be identical with the offer and unconditional. Where a person offers to do a definite thing, and another accepts conditionally, or introduces a new term into the acceptance, his answer is either

a mere expression of willingness to treat or it is a counter proposal, and in neither case is there an agreement." 9 Cyc. 267.

Mr. Justice Washington states the rule in *Eliason v. Henshaw*, 4 Wheat. 225, 228, 4 L. Ed. 556, as follows:

"It is an undeniable principle of the law of contracts that an offer of a bargain by one person to another imposes no obligation upon the former until it is accepted by the latter according to the terms in which the offer was made. Any qualification of or departure from those terms invalidates the offer, unless the same be agreed to by the person who made it. Until the terms of the agreement have received the assent of both parties, the negotiation is open and imposes no obligation upon either."

The principle is distinctly approved and followed in a later case in the Supreme Court, namely, *Carr v. Duval*, 14 Pet. 77, 10 L. Ed. 361. So in *James v. Darby*, 100 Fed. 224, 227, 40 C. C. A. 341, 345, Rogers, District Judge, sitting in the Circuit Court of Appeals, Eighth Circuit, says:

"The rule is unvarying, and the authorities uniform, that in order to constitute an acceptance of an option, or an offer to sell, the acceptance must be unconditional. There must be no new terms imposed, and no departure from those offered. If to the acceptance a condition be affixed, or any modification or change in the offer be requested, by the party to whom the offer is made, this, in law, constitutes a rejection of the offer."

The nicety and strictness with which the rule should be observed is characterized by the language of Severens, District Judge, sitting in the Circuit Court of Appeals, Sixth Circuit, in *Kleinhans v. Jones*, 68 Fed. 742, 749, 15 C. C. A. 644, 651. He says:

"Where it is apparent that one party has not consented to the several terms to which the other has agreed, no contract is formed. If the divergence is of anything which partakes of the substance of the contract at all, there is no legal agreement; and the court is not at liberty to speculate upon the question whether some stipulation which it might think of minor importance, or some variation which it might think would not have influenced the parties in making the contract, can be dispensed with, and the parties held, in disregard of them."

To like purpose see, further, *Kelsey v. Crowther*, 162 U. S. 404, 16 Sup. Ct. 808, 40 L. Ed. 1017, and *Equitable Life Assur. Soc. v. McElroy*, 83 Fed. 631, 28 C. C. A. 365.

Under these authorities, treating defendant's letter of the 18th as an offer to sell for a cash price of \$5,000 (and such it was in reality in legal effect), the acceptance was coupled with conditions which must be deemed material and of substance, the most vital of which is that defendant was required to send an abstract of the title. It is also of importance that the deed was required to be made and executed in blank as it pertained to the name of the grantee, and that the money was made payable to the Bankers' & Lumbermen's Bank in Portland, rather than at Junction City, the place of residence of the defendant. While the defendant asserted that his title was good, his offer did not include the furnishing of an abstract, which would be of some trouble and expense to him. Furthermore, he proposed to sell to the agents, and to none other. Being agents for plaintiffs, the proposal might be considered as one to sell to the principals; but it could not be extended to include any one whose name the agents might deem expedient to

enter in the blank. It was also important that the defendant should be paid at the place of his residence. The implication of his offer was that he should be so paid. It cannot be said that the acceptance was flat, and that the other matters contained in the McClintock & Lacey letter of March 20th were mere suggestion; for the condition was imposed that the \$5,000 should be paid at the Bankers' & Lumbermen's Bank of Portland, when the deed was executed as indicated, and it, together with an abstract of title, was sent to such bank. That such conditions were matters of substance can scarcely be questioned, and, under the strict rule of the law, the concluding letter of McClintock & Lacey did not constitute an acceptance of defendant's offer to sell.

For these reasons, the findings and judgment of the court must be for the defendant. The complaint of plaintiffs will therefore be dismissed.

SMITH v. COOK et al.

(District Court, E. D. Pennsylvania. October 30, 1908.)

No. 67.

SEAMEN (§ 29*)—PERSONAL INJURIES—ASSUMED RISK.

Libelant, who was 17 years old and employed as mess boy on a steamer then lying at a dock, was called from his berth in the early morning by the boatswain and ordered to assist others in paying out a line attached to a pile while the vessel was being moved to another berth. While so engaged the line slipped from the drum on which it was wound, and libelant's foot was caught in a coil, and his leg torn off. Such work was not in the line of his employment, and it did not appear that he was familiar with the danger. *Held*, that he did not assume the risk therefrom, and that the vessel was liable for his injury; it not appearing that he was negligent.

[Ed. Note.—For other cases, see Seamen, Dec. Dig. § 29.*]

In Admiralty. On final hearing.

John M. Patterson and Cornelius Haggarty, Jr., for libelant.
John F. Lewis and Francis C. Adler, for respondents.

HOLLAND, District Judge. On August 15, 1902, Robert Smith, the claimant, was working as mess boy on the steamship John J. Hill, and on that date received a personal injury by having his leg caught in a hawser and torn completely off below the knee. The vessel was moored along the Allegheny Avenue Wharf, in the Delaware river, in this district. Smith brought an action in trespass in the court of common pleas of the county of Philadelphia against Arthur G. Cummer, Waldo E. Cummer, and Henry W. Cook, owners of the steamship, to recover damages for his injury. The summons in the state court was served only upon Cook, who thereupon presented his petition to this court to have the action removed and his liability limited as provided by law, reserving the right to contest any liability whatever for the injury to Smith in this court, to which the case has been removed, and he is entitled to make this contest for the purpose of ascertaining whether or not Smith is entitled to recover anything

*For other cases see same topic & § NUMBER in Dec. & Am. Digs. 1907 to date, & Rep'r Indexes

against him. As a result of the proceedings for a limitation of liability, Mr. Cook filed a stipulation in the sum of \$8,000, being the appraised value of his interest in the steamship.

Robert Smith, on the day of the accident, at about 5:30 o'clock a. m., was helping two other men to pay out a line fastened to a windlass in the bow through a starboard mooring chock to a piling on the wharf. The vessel was being towed out of the dock, and Smith, with the others, was steadying her bow with this line, as is customary, and in doing this work in some way the line slipped off the drum of the windlass, caught Smith's leg in a coil, and drew him to the mooring chock, where his leg was pulled off below the knee and fell into the water. There is no dispute as to these facts. The only question is whether or not the owners of the steamship are in any way responsible for the injury received by this young man. As usual, in these cases, the evidence is conflicting and most of it unreliable, rendering it extremely difficult to ascertain which is in the right. It is claimed for libellant that he was but 17 years of age, and employed on the vessel as mess boy, and that on this morning, the most of the crew having been discharged in the home port and the vessel being short-handed, he was called out of bed by the boatswain to help take in the lines to move the boat to the loading pier, and the responsibility of the owners lay in the fact that he was ordered to perform duties that were not within the scope of his employment and of the nature and danger of which he was ignorant; while the owners contend that Smith went to the aid of Kelly in handling the bow rope of his own free will and without any request or command on the part of his superiors on the vessel, and that he was guilty of the grossest negligence in standing on the coil of rope being paid out.

The story of Smith is that he was asleep in his bunk, and at about 5:30 a. m. he was awakened by the boatswain calling him on deck "to give a hand." Smith objected upon the ground "it was not his work," but was again shortly thereafter called by the boatswain, and was told by the steward to "go up and see what he wants"; and Smith "slipped on his pants and shirt and went on deck," and the boatswain "in a threatening manner" ordered him to return and dress properly and come on deck, which he did, and was then sent forward to find "Jack Kelly" and "give him a hand." Kelly and a stevedore were steadying the bow of the vessel, which was being towed out into the stream by paying out this hawser gradually from a windlass through the mooring chock as the boat receded. Smith took hold of the rope in front of Kelly, and about that time it slipped off of the drum of the windlass, and Smith, in an endeavor to re-coil the hawser on the drum at the suggestion of Kelly, was caught in the rope which was being paid out. He had stepped on the rope, but was entirely unaware of any danger that might result from so doing. This story is corroborated by the boatswain; but the latter's evidence is discredited by the fact that he had previously sworn to a statement in accord with the story told by some of the witnesses for the defendant, and while under examination denied that he had given such a statement, and shortly afterwards acknowledged he had sworn falsely, and gave as an excuse he did not remember he had written a statement, and, as

to the other, that he swore to it because he was afraid he would lose his job if he refused.

The defense is that Smith was anxious to be a sailor man and that he voluntarily did this work, and, after being awakened and appearing on deck without being fully dressed, he was told that his services were not needed, but that because of his anxiety to learn the work of a sailor he went below, dressed himself properly, and returned, and of his own notion went forward and helped Kelly in the work he was doing in steadying the vessel. The captain stated that he had directed the boatswain to request the steward to help in taking in the lines, and that he (the steward) did not appear with the mess boy for more than 20 minutes after the work had begun, and that he (the captain) then told the steward that he did not require him or the mess boy, as the work was nearly done. The evidence of the steward is to the effect that he and the mess boy were called by the boatswain to help in taking in the lines, but that the steward did not come on deck at all, but went on making his fire after he had been awakened, and that the mess boy went on deck, and returned shortly thereafter, and stated to the witness that he was not wanted, as the work was all done, and that he (the witness) was not on deck until after the accident had occurred. This is the evidence for the defense to show that the libelant volunteered to do this work and in doing it stepped upon the coil of rope which was being paid out, and in so doing was so grossly negligent that he cannot recover.

It will be noted that the story of the captain and that of the steward is entirely different, although both are offered for the purpose of showing that the mess boy was not ordered to do this work, and they tend to establish that fact; but it seems to me improbable that a boy 17 years of age would voluntarily, after being awakened out of a sound sleep so early in the morning on a summer's day, offer to do work which was not in the line of his duty, and especially so if told that he was not needed to aid in its performance. Yet to believe the evidence produced on the part of the defense it is necessary to find that this boy, after being awakened out of a sound sleep with some trouble and urging on the part of the steward and having gone on deck, was told his services were not needed, that he would take off his boots that he was said to have worn by the steward, put on his shoes, return to the deck, and go forward without being ordered, to help two men pay out a line over a windlass, when the boatswain was working aft alone. The truth seems to be that the captain, through the boatswain, ordered both the steward and the mess boy to go on deck and help take in the lines, and when the boy appeared, improperly clothed, he was ordered to dress, return on deck, go forward, and help Kelly. He had only been on the vessel a month. There is evidently considerable danger in handling a rope under such circumstances as appear in this case. The boy evidently did not know the danger of stepping upon the pile of coiled rope in his effort to place the hawser on the windlass, and I am unable to find that he voluntarily did the work, or that he was guilty of negligence in failing to avoid the coiled rope.

The fault charged upon the respondent is that the libellant was "ordered and compelled to perform the duty that was not within the scope of his employment and of the nature and danger of which he was ignorant." The fact that the work was nearly completed at the time the boy arrived upon deck the second time, and that he may not have been needed in the work of taking in the lines and steadying the bow of the vessel as she was being towed out, is immaterial. If he had been directed by the boatswain to do this work, which was "not within the scope of his employment and of the nature and danger of which he was ignorant," he did not perform it voluntarily, and it is entirely likely that, with his youth and inexperience, he was ignorant of the danger which beset the work he was about to perform. The case rather falls within that line of decisions which hold that, where a young or inexperienced servant is injured while acting in obedience to the commands of the master, he will not be held to have assumed the risk involved in so doing, even though he may see that the work is dangerous and the machinery furnished by the master of the vessel is defective. A seaman aboard a ship must obey orders. The command of the master and prompt obedience of the seamen and all aboard are frequently so important that the very safety of the vessel depends upon it. Dangers of navigation, resulting from storms and various other difficulties which are incident to water transportation and travel, make it necessary that all on board the ship should promptly obey the commands of their superiors, and the law is that, even if the captain be in the wrong, the seamen must, as a general rule, obey his orders at sea and wait for redress until the vessel returns to port. This rule, however, cannot be so strictly enforced while the vessel is moored at a dock, where no danger can come to her. Yet even then it is the duty of the crew to obey its superiors in all reasonable commands in connection with their work upon the vessel; but where, as in this case, a young man has been directed to perform work admittedly not within the scope of his employment, those in authority directing him to perform the work are required to know that he is acquainted with any danger in connection with its performance. In this case it is not apparent that Smith knew the dangers surrounding him in the work he was directed to perform.

For these reasons, we hold that the vessel is liable, and a decree will be entered accordingly.

Ex parte MARRIN.

(District Court, E. D. New York. October 7, 1908.)

1. BAIL (§ 60*)—BOND BY SURETY COMPANY—STATUS.

A bail bond given by a surety company for the appearance of a defendant in a criminal case in a federal court, as authorized by Act Aug. 13, 1894, c. 282, 28 Stat. 279 (U. S. Comp. St. 1901, p. 2315), differs in no way, so far as its legal status is concerned, from the bond of an individual surety.

[Ed. Note.—For other cases, see Bail, Dec. Dig. § 60.*]

*For other cases see same topic & § NUMBER in Dec. & Am. Digs. 1907 to date, & Rep'r Indexes

2. HABEAS CORPUS (§ 45*)—FEDERAL PRISONER AT LARGE ON BAIL—ARREST BY STATE AUTHORITIES—DISCHARGE BY FEDERAL COURT.

A defendant charged with a criminal offense in a federal court, and at large on bail pending a determination of his case by an appellate court, when arrested and held in custody by the authorities of a state, outside of the jurisdiction of the federal courts in which his case is pending, to answer to an indictment in the state court, is not so held in violation of his constitutional rights or contrary to any law of the United States which entitles him to a discharge by a federal court on a writ of habeas corpus, where neither the United States nor his surety demand such discharge.

[Ed. Note.—For other cases, see Habeas Corpus, Cent. Dig. § 40; Dec. Dig. § 45.*]

Habeas Corpus.

George Young Bauchle, for petitioner.

William P. Allen, Asst. U. S. Atty., John F. Clarke, Dist. Atty., and Peter P. Smith, Asst. Dist. Atty., for respondents.

George L. Naught, for American Surety Company.

CHATFIELD, District Judge. The present application is based upon a writ of habeas corpus issued out of this court upon the petition of Frank C. Marrin, the person claimed to be imprisoned without warrant of law. The facts of the proceeding are as follows:

Upon the 3d day of May, 1895, the grand jury of the county of Kings, in the state of New York, found true bills of indictment against Frank C. Marrin upon charges of forgery and grand larceny. These indictments have been pending, undisposed of, until the present time. The record upon this proceeding shows some dispute as to the whereabouts of Marrin from the time of the finding of the above indictments until the year 1907, but nothing that bears upon the present application occurred until Marrin was arrested in Buffalo, N. Y., by the United States authorities, upon an indictment found in the District Court for the Eastern District of Pennsylvania, charging a scheme to defraud under the postal laws of the United States. Upon that charge Marrin was removed to Philadelphia, tried, convicted, and sentenced upon October 3, 1907, to four years' imprisonment, to pay a fine of \$5,000, and to pay the costs of the trial. From that sentence an appeal has been taken, which appeal is now pending and has progressed to such a point that, on the 15th day of June, 1908, Marrin was released from custody by the United States court in Philadelphia upon a bail bond, running during the pendency of the appeal, in the sum of \$10,000. This bail was furnished by a surety company, and the return to the writ of habeas corpus contains an allegation that the surety company has been indemnified for the amount of this bail bond.

The charge is suggested that the surety company does not take interest in being able to produce the defendant to the extent that a personal surety might, for the reason that the indemnity held by the company, coupled with the payment of a premium and the reputation acquired through prompt payment of a defaulted bond, render them indifferent to the actual production of the person bailed, in accordance

*For other cases see same topic & § NUMBER in Dec. & Am. Digs. 1907 to date, & Rep'r Indexes

with the terms of the bond. For the purposes of the present application this, however, would seem to be entirely immaterial. A bail bond given by a surety company is authorized by Act Aug. 13, 1894, c. 282, 28 Stat. 279 (U. S. Comp. St. 1901, p. 2315), has been accepted by the courts frequently since the passage of the law, and differs in no way, so far as its legal status is concerned, from the bond of an individual. The question of motive, unless the issue of good faith is material, has nothing to do with this application.

Upon the 19th day of September, 1908, while Marrin was in the borough of Brooklyn, in the state of New York (and therefore without the boundaries of the Eastern district of Pennsylvania, and beyond the territorial jurisdiction of the United States court and of the Circuit Court of Appeals, in which the case above mentioned was pending), a warrant, based upon the old indictments filed in Kings county in 1895, was obtained from the County Court of the county of Kings, and upon this warrant Marrin was arrested in the city of New York, brought to the county of Kings, and arraigned upon the 1895 indictments. Upon the arraignment and upon the adjourned day the defendant Marrin stood mute, protesting against the jurisdiction of the County Court, and upon the 2d day of October, 1908, obtained this present writ of habeas corpus, addressed to the district attorney of the county of Kings, the warden of the city prison, and the American Surety Company of New York. On the return day the warden of the city prison has produced the petitioner and has filed a return setting forth the commitment of the County Court for the county of Kings, under date of October 2, 1908. The district attorney for the county of Kings joins in this return and sets up the pertinent facts of the record above recited. The American Surety Company appeared in court, by attorney, made no answer to the writ, and disavowed any interest in the matter, except in the obligation imposed upon it by the bail bond furnished in the city of Philadelphia. The application was brought to the attention of the United States through the district attorney of the United States for the Eastern district of New York, the United States was represented in court by an assistant United States attorney for this district, and the statement was entered upon the record that the United States had no motion to make, did not apply for the custody of the said Frank C. Marrin, and cared neither to join in nor oppose the present application.

One further matter must be noted in connection with the facts of the situation. On the 14th day of March, 1907, in the city of Philadelphia, while awaiting trial in the United States District Court for the Eastern District of Pennsylvania, Marrin was released on bail, and thereafter arrested in the city of Philadelphia upon a bench warrant based upon the indictments found in the County Court of Kings county above referred to, with a view to his extradition to the state of New York. Immediately thereafter a writ of habeas corpus was procured out of the United States District Court for the Eastern District of Pennsylvania, and upon the hearing Marrin was discharged. He was thus freed from the arrest on the bench warrant in Philadelphia, but was held by the United States District Court upon his bail bond to await

trial on the indictment then pending in the United States District Court for that district. It will thus be seen that Judge McPherson held a release upon bail in the city of Philadelphia to be equivalent to the custody of the United States court for that district, and that a defendant in custody and awaiting trial could not be taken out of the jurisdiction of the court without the permission of the court itself.

The attention of this court has not been called to any opinion of Judge McPherson, and the record does not show whether he decided that Marrin should be held for trial because the United States District Court had jurisdiction over him and did not relinquish the same, thus compelling the state authorities in Philadelphia to wait until the United States authorities should turn over Marrin to them, or whether Judge McPherson intended to hold that Marrin, while out on bail, was legally in the position of a defendant in the physical custody of the United States marshal and committed in default of bail.

The record of the case as above set forth appears, as has been stated, from the petition, the returns, and an exhibit presented at the hearing. The return of the warden and the district attorney was not traversed, and the petitioner, Marrin, contented himself with arguing upon the face of the record that the County Court of Kings county could not retain jurisdiction of his person and hold him for trial at the present time, but that he must be released and allowed to hold himself in readiness to deliver himself or be delivered by his surety to the District Court of the United States in the Eastern District of Pennsylvania, whenever the surety might desire to surrender him, under the provisions of section 1018 of the Revised Statutes (U. S. Comp. St. 1901, p. 719), or whenever the terms of the bail bond on appeal should be fulfilled and his attendance should be required.

This contention is directly opposed by the district attorney of the county of Kings, who in person and as attorney for the warden has argued the writ on behalf of the respondents. The district attorney contends that while a person is at large on bail no immunity as such exists guaranteeing him freedom from arrest for crime committed prior to the giving of bail or subsequent thereto. The district attorney cites as an illustration of his argument the following proposition: Suppose a man were arrested in New Jersey for a so-called technical violation of the internal revenue laws of the United States, and held by the United States court for trial in the sum of \$250 bail, and should put up cash bail therefor. Suppose, then, that this person should cross into New York and commit murder, or some other unbailable offense, and upon his arrest should claim, upon application for a writ of habeas corpus, that he must be released in order to be present in New Jersey, inasmuch as he was theoretically in the custody, at the time of committing the murder, of the United States authorities in the state of New Jersey. The circumstances of the present application make it unnecessary to consider the discretion which undoubtedly exists in the courts of the various states with respect to allowing a man to be tried for a second offense while awaiting trial, or even while under sentence, upon an earlier charge.

The argument of the petitioner, Marrin, arises from the older idea of bail and the right of the surety to coerce or compel the presence of his

principal in order to carry out the terms of the bond. Bail, in many instances, provides merely for the release of the individual, in order that he may go at large within certain bail limits, and thus the bail limit is but an extension of the boundaries of the jail. The defendant is thus confined or detained within an enlarged jail. But in a bail bond such as the one at present under discussion no limit is imposed. The only condition is that the defendant appear at the time appointed, and the tendency for a number of years has been to treat such a bail bond as a contract, rather than purely as a fictionary wall, outside of which the court could not recognize the identity of the prisoner, except as a fugitive or escaped prisoner.

Jurisdiction to grant a writ of habeas corpus is given by section 751 of the Revised Statutes (U. S. Comp. St. 1901, p. 592), and section 753 is as follows:

"The writ of habeas corpus shall in no case extend to a prisoner in jail, unless where he is in custody under or by color of the authority of the United States, or is committed for trial before some court thereof, or is in custody for an act done or omitted in pursuance of a law of the United States, or of an order, process, or decree of a court or judge thereof, or is in custody in violation of the Constitution or of a law or treaty of the United States," etc. U. S. Comp. St. 1901, p. 592.

It might be questioned whether the present application is within the strict interpretation of the words just quoted, and for that reason this court might, in the first instance, have taken under advisement the question of authority to issue this writ. But, as has been said in the case of *In re Fox* (D. C.) 51 Fed. 430, while the imprisonment set forth is not claimed to be in violation of any particular statute law of the United States, it is claimed to be in violation of the laws of procedure, and of the laws fixing jurisdiction in the United States courts themselves. Such an interpretation of section 753 has been approved in the case of *In re Neagle*, 135 U. S. 1, 10 Sup. Ct. 658, 34 L. Ed. 55.

The authority of the United States courts to release a defendant from the custody of the state authorities, if his case is covered by the statutes, is plainly set forth in *United States v. Booth*, 62 U. S. 506, 16 L. Ed. 169, and was also recognized in the case of *United States v. French*, 1 Gall. 1, Fed. Cas. No. 15,165. But the granting of a writ of habeas corpus and the hearing of the application does not carry with it necessarily the discharge of the defendant from the imprisonment complained of.

A number of considerations present themselves which need only be stated. The liability of the surety on the bond, or the insufficiency of any excuse for non-performance, if the surety cannot return Marrin to the United States court in Philadelphia because of his detention here, is discussed in the case of *Taylor v. Taintor*, 83 U. S. 366, 21 L. Ed. 287. In the *Matter of Beavers* (C. C.) 131 Fed. 366, the right of the United States to forego or delay the prosecution of a pending charge in a particular district, and to take up a case in some other district and remove the defendant there for trial, was sustained upon the ground that the United States had jurisdiction over both matters, and in its discretion, when approved by the discretion of the court, had

the right to determine to which case the administration of justice required should be given priority.

It has also become well settled that if a party is on trial or in duress—that is, in actual custody—under the authority of a state court, no other state court, and no United States court, should, except in an urgent case, take the defendant from that custody, prior to an actual release or relinquishment of the right to the custody on the part of the court before which the matter is pending. *Ex parte Royall*, 117 U. S. 241, 6 Sup. Ct. 734, 29 L. Ed. 868; *Ex parte Fonda*, 117 U. S. 516, 6 Sup. Ct. 848, 29 L. Ed. 994; *Cook v. Hart*, 146 U. S. 183, 13 Sup. Ct. 40, 36 L. Ed. 934.

Nor are we concerned here with the merits of the indictments or charges. The guilt or innocence of the accused in either jurisdiction has no bearing upon the question. In *re Roberts* (D. C.) 24 Fed. 132. There are but three parties whose rights are to be considered in determining the questions: First, can the surety complain if this court does not treat the defendant, Marrin, as if in actual physical custody of the United States marshal for the eastern district of Pennsylvania, and as if he had temporarily escaped therefrom; his presence in Philadelphia and his rearrest being desired by the authorities there? Second, do the United States authorities in Philadelphia demand, and do the ends of justice require, an unbroken prosecution of the case in that district, and the actual attendance of the defendant, even though he has been released on bail pending the appeal, which has caused a long interval during which his attendance in court was unnecessary? And, third, if neither the surety nor the United States authorities have the right to nor do demand, for the ends of justice, the presence of the defendant in custody in Philadelphia, can the defendant in effect elect not to be prosecuted, or even not to be arrested, for any cause whatever, so long as his bail bond returnable to the court in Philadelphia is outstanding?

The first of these questions has been substantially answered in the reference to the case of *Taylor v. Taintor*, *supra*, but it is the language of the court in the case of *Taylor v. Taintor* upon which the defendant principally bases his contention.

The second proposition has been partially answered in the reference to the *Beavers Case*, *supra*. But the present case differs from that in this respect: That here the United States is not waiving the right to trial in one district for the sake of trial in another, but is standing mute and waiving its right to the presence of the defendant, with the knowledge that he may be tried in the courts of the state of New York. There would seem to be no difference. If the United States authorities, through the Department of Justice, relinquish the actual custody of a defendant, and he should be tried and sentenced somewhere else, the cases above cited would show that the jurisdiction of the state court, if it properly attached, should be respected, and the United States could not be heard to complain that its procedure had been interfered with. The effect upon a bail bond has been above referred to, but does not alter the position of the principal.

The third proposition, based upon the apparent language in the case

of Taylor v. Taintor, supra, is on all fours with the contention in the case of In re Fox (D. C.) 51 Fed. 427. In that case, as in the present, the United States court saw fit to issue a writ of habeas corpus and to determine the question upon the return of that writ. The Fox Case, however, arose in the same district of the United States court in which he had been held on bail for trial, the same attorney had acted as the representative of the United States in the conduct of the case in which bail had been received as appeared upon the application for a hearing upon the writ of habeas corpus, and this United States attorney made no effort to resist or to terminate the taking of the defendant in that case away from the jurisdiction of the United States court. In other respects the Fox Case seems to be entirely similar to the one at bar, and, as said in the Beavers Case, supra, the authority of the United States exists throughout the entire country. The desire of the Department of Justice to prosecute a case can be manifested and insisted upon in one jurisdiction as in another. The authority of the United States, so far as appearance in court is concerned, rests upon the United States attorney for the particular district.

Judge McPherson, in the habeas corpus proceedings in Philadelphia, exercised his discretion and apparently acted upon the demand of the United States that the authority of the United States District Court in that district be not relinquished. But this is entirely different from the question now raised. In the present application no motion is made by the United States. The physical custody of the defendant has been given up, and a contract on the part of the defendant to appear, and on the part of his surety to produce him, at a certain time, has been accepted, with the approval of the United States court in the Pennsylvania district. No rights would seem to be violated by the exercise of the jurisdiction which the state courts of Kings county have exercised over the subject-matter of the case and over the person of the defendant, and all questions which may arise in Philadelphia, in the event of a trial in Kings county, and sentence (if conviction should result), can then be satisfactorily disposed of.

If the presence of the defendant in Philadelphia were demanded by the United States, and if the ends of justice seemed so to require, it is believed that this court, in the exercise of its discretion, could enforce the jurisdiction of the United States District Court for the Eastern District of Pennsylvania, and compel the return of the defendant for such further proceedings as might there be proper; but under the existing conditions of the case the exercise of this discretion is unnecessary, and the defendant or petitioner is not entitled to ask as a right what does not seem to be proper as a matter even of discretion.

Frank C. Marrin, therefore, does not seem to be held contrary to any law of the United States, nor in violation of any of his constitutional rights, and the writ of habeas corpus must be dismissed, and the defendant returned to the warden of the city prison, in the Borough of Brooklyn, to be held under the commitment of the County Court of Kings county.

STICKNEY et al. v. INTERSTATE COMMERCE COMMISSION.

(Circuit Court, D. Minnesota, Third Division. June 30, 1908.)

1. CARRIERS (§ 26*)—INTERSTATE COMMERCE ACT—LEGALITY OF TERMINAL CHARGE.

Where railroad companies engaged in the transportation of live stock from points in other states to the Union Stockyards in Chicago have fixed a terminal charge for the moving of each car from the end of their own tracks in Chicago to the stockyards, stating the through rate to the end of their tracks and the terminal charge separately in their schedules, as required by section 6 of the interstate commerce act (Act Feb. 4, 1887, c. 104, 24 Stat. 380 [U. S. Comp. St. 1901, p. 3156], as amended by Act June 29, 1906, c. 3591, § 2, 34 Stat. 586 [U. S. Comp. St. Supp. 1907, p. 895]), the legality of each charge must be determined by itself, without regard to the other; and where the terminal charge, considered by itself, is reasonable for the service rendered, the Interstate Commerce Commission is without power to reduce it on the ground that, when added to the through rate, the total charge from the point of shipment to the stockyards is excessive.

[Ed. Note.—For other cases, see Carriers, Cent. Dig. §§ 70, 71; Dec. Dig. § 26.*]

2. COMMERCE (§ 91*)—INTERSTATE COMMERCE COMMISSION—POWER OF COURTS TO REVIEW ORDERS.

Under the provisions of sections 15 and 16 of the interstate commerce act (Act Feb. 4, 1887, c. 104, 24 Stat. 384 [U. S. Comp. St. 1901, p. 3165], as amended by Act June 29, 1906, c. 3591, §§ 4, 5, 34 Stat. 589, 590 [U. S. Comp. St. Supp. 1907, pp. 900, 902]), the courts have jurisdiction to set aside or suspend any order of the Interstate Commerce Commission resulting from a misconception and misapplication of the law to conceded or undisputed facts.

[Ed. Note.—For other cases, see Commerce, Dec. Dig. § 91.*]

In Equity. On motion for preliminary injunction.

William D. McHugh, for complainants.

L. A. Shaver and Samuel H. Cowan, for defendant.

Before SANBORN, HOOK, and ADAMS, Circuit Judges.

ADAMS, Circuit Judge. This is a bill in equity, brought by the railroad companies, which are complainants, against the Interstate Commerce Commission, to enjoin the enforcement of an order made by the latter requiring them to desist from charging \$2 per car for transporting live stock brought from outside the state of Illinois, from the ends of their roads in Chicago to the Union Stockyards, and not to exact for that service hereafter a greater sum than \$1 per car. The present submission is on a motion for a temporary injunction based on the bill, answer filed thereto, and exhibits filed with both, to restrain the enforcement of that order or to suspend its operation until a final hearing can be had on the merits. The case is brought on for hearing before three Circuit Judges by virtue of a certificate of the Attorney General made pursuant to the provisions of section 5 of the amended interstate commerce act (Act June 29, 1906, c. 3591, 34 Stat.

*For other cases see same topic & § NUMBER in Dec. & Am. Digs. 1907 to date, & Rep'r Indexes

584 [U. S. Comp. St. Supp. 1907, p. 902]), and Act Feb. 11, 1903, c. 544, 32 Stat. 823 (U. S. Comp. St. Supp. 1907, p. 951).

The pleadings and exhibits disclose that since the year 1894 the Interstate Commerce Commission has frequently had the question of the above-mentioned terminal charge before it, and has repeatedly ordered its reduction from \$2 per car to \$1 per car. Under the original interstate commerce act of 1887 (Act Feb. 4, 1887, c. 104, 24 Stat. 379 (U. S. Comp. St. 1901, p. 3154), the orders of the commission were not self-executing, but required compulsory orders to that effect by a court of competent jurisdiction. Upon the railroads declining to obey the first order to reduce the charge the commission instituted a proceeding in the Circuit Court of the United States for the Northern District of Illinois to secure its enforcement. The trial court decided in favor of the commission, but its judgment was reversed on appeal by the Circuit Court of Appeals for the Seventh Circuit. *Walker v. Keenan*, 19 C. C. A. 668, 73 Fed. 755. Afterwards, upon a new case made, the commission again entered an order reducing the terminal charge from \$2 to \$1 and again sought its enforcement in the Circuit Court. Both the Circuit Court and the Circuit Court of Appeals for the Seventh Circuit decided against the commission and refused to enforce it. *Interstate Commerce Commission v. Chicago, B. & Q. R. Co.*, 43 C. C. A. 209, 103 Fed. 249. Upon an appeal from the judgment of the Court of Appeals in the last-mentioned case the Supreme Court of the United States, in 1902, affirmed its judgment. *Inter. Com. Commission v. Chicago, etc., R. Co.*, 186 U. S. 320, 22 Sup. Ct. 824, 46 L. Ed. 1182.

In February, 1903, the Cattle Raisers' Association of Texas and the Chicago Live Stock Exchange filed a petition asking the commission to open up the case again to enable them to conform to certain observations made by the Supreme Court. This was done, and resulted in a third order by the commission requiring the railroads to desist from exacting the terminal charge of two dollars. This decision was rendered in August, 1905. Nothing further seems to have been done until December 3, 1906, when, after the passage of the amendment to the interstate commerce act approved June 29, 1906 (34 Stat. 584, c. 3591 [U. S. Comp. St. Supp. 1907, p. 892]), known as the "Hepburn Act," the Cattle Raisers' Association of Texas and the Chicago Live Stock Exchange again complained to the commission that the complaining railroad companies had violated the provisions of the interstate commerce acts in laying the charge of \$2 per car for the terminal service in question in Chicago. We suppose this additional proceeding was inspired by the Hepburn act, which made the orders of the commission conclusive, subject only to a court review as provided for by the fifteenth and sixteenth sections of the interstate commerce act as amended. On October 21, 1907, the commission again decided that the terminal charge of \$2 per car was unjust and unreasonable, and thereafter, to wit, on December 10, 1907, made an order that such charge should not exceed \$1 per car and fixed February 1, 1908, as the date when the order should go into effect. Under the new law (Act June 29, 1906, c. 3591, §§ 5, 6, 34 Stat. 589, 590 [U. S.

Comp. St. Supp. 1907, pp. 900, 902]) this order became effective proprio vigore at the time fixed by the commission therefor, and required obedience under heavy penalties, unless upon review by the courts at the instance of the railroads it should be enjoined, set aside, annulled, or suspended. Availing themselves of the right accorded by the act, the railroad companies now appeal to this court for relief against that last order.

In view of the protracted history of this case we find it unnecessary to restate many of the facts. By referring to the opinions of the courts already cited, and particularly to that of the Supreme Court of the United States in *Interstate Com. Comm'n v. Chicago, etc., R. Co.*, supra, all essential detail can be found. For our present purposes it is sufficient to say that it stands conceded by the pleadings that the actual cost to complainants of carrying live stock from their respective terminal yards at the ends of their lines or roads in Chicago to the Union Stockyards exceeds the sum of \$2 per car. This expenditure is for trackage from the ends of their rails over the track of the Union Stockyards & Transit Company and making deliveries of the stock at the stockyards and is for a service totally distinct and separate from that involved in the transportation over their own lines to the ends of their rails. As such terminal service it was required by the original interstate commerce act (Act Feb. 4, 1887, c. 104, § 6, 24 Stat. 380 [U. S. Comp. St. 1901, p. 3156]), and by the amended act (Act June 29, 1906, c. 3591, § 2, 34 Stat. 586 [U. S. Comp. St. Supp. 1907, p. 895]), that it should be separately scheduled by the carriers. The original act provided that the published schedules of rates, fares and charges, "shall also state separately the terminal charges," and the amended act emphasized this requirement by the use of the following language:

"The schedules printed as aforesaid by any such common carrier shall plainly state the places between which property and passengers shall be carried and shall contain the classification of freight in force and shall also state separately all terminal charges, storage charges, icing charges and all other charges which the commission may require, all privileges or facilities granted or allowed and any rules or regulations which in any wise change, affect or determine any part or the aggregate of such aforesaid rates, fares and charges or the value of the service rendered the passenger, shipper or consignee."

Prior to 1894 the railroad companies made no additional charge for transporting live stock from their own terminals in the city of Chicago and delivering the same to the Union Stockyards. The rate fixed and charged for transportation from the points of origin of the freight to the ends of their own rails in Chicago included all the compensation they received for the service of delivery at the stockyards; but in that year the Union Stockyard & Transit Company made a trackage charge for the use of its tracks for that service ranging from 80 cents to \$1.50 per car according to the extent of the track used by the different roads respectively. This additional burden and the enhanced complexity and general cost of the special service, according to the averments of the bill, "made it impracticable to continue to make deliveries beyond the lines of their respective railroad tracks without any charge or compensation therefor." For these reasons, as averred, the rail-

road companies laid a charge for it of one uniform price of \$2 per car and undertook to conform their published schedule of rates and charges thereto.

This was the condition of things as the case stood when heard by the Court of Appeals for the Seventh Circuit and the Supreme Court. The Court of Appeals twice justified the imposition of the extra charge on the ground, generally speaking, that the carriers had a right to segregate the terminal charge in question from the other rates over their main lines, and had done so, and that they had a right to make an additional charge, not exceeding the cost thereof, for that service, and that the charge of \$2 a car as laid was just and reasonable and should be sustained. See cases supra. The Supreme Court held that the carriers had the right to divide their rates, so as to make a distinct charge for service from the point of shipment to Chicago and a separate charge for service in transporting and delivering live stock from their own terminals to the Union Stockyards, but held that they had not made such a division by any such clear and plain statement as is required by the interstate commerce law. After referring to the provision of law requiring the separate statement of terminal charges, the court said:

"The purpose of this provision was to compel the schedules to be so drawn as to plainly inform of their import—was to exact that, when the rates were changed, the change should be so stated as not to mislead and confuse."

The conclusion reached was that the carriers in this case had not made the required division and separate statement of their terminal charges; that all they had done was to add the sum of \$2 to the prior through rate, which up to that time had embraced the terminal charge. Mr. Justice White, speaking for the court, said:

"We think that it cannot be said that to add an additional amount to a former charge was necessarily to divide such former charge, without holding that to add one sum to another is necessarily to divide the other."

Notwithstanding this conclusion, the judgment of the Court of Appeals was affirmed on other grounds. The opinion concludes as follows:

"We think, however, in view of what has been said, and in order to prevent all possible misconception, that it should be stated that nothing in the decree refusing to execute the order of the commission should be construed as preventing that body, if it deems it best to do so, from hereafter commencing proceedings to correct any unreasonableness in the rate resulting from the additional terminal charge as to any territory to which the reduction referred to in the opinion, if any such there be, did not apply."

Adopting the suggestion of the Supreme Court, the carriers soon thereafter made an amendment of their published and filed schedules, and by clear and unequivocal language segregated the terminal service from the transportation over their main lines to Chicago, and definitely fixed the rate for the separated terminal service at \$2 per car.

In view of the right and duty of the carriers to make a segregation, and of the fact that one has been actually made, and of the further fact that the charge laid for the separate terminal service is

in itself just and reasonable, not more than the actual cost thereof, it would seem to follow that it should not be reduced. Neither the commission in its reports nor learned counsel in their argument attempt to justify the reduction on the ground that the charge as actually laid was too much for the particular service rendered, but solely on the ground that if the charge of \$2 a car for the terminal service should be allowed, even though it be only a just and reasonable compensation therefor, the result would be that the rate from the origin of shipment to the ends of the rails in Chicago would become too high, and thereby the cost of transportation from the origin of shipments to the Union Stockyards would be excessive.

It is said that the carriers for many years before 1894 made no separate charge for the terminal service in question, but absorbed it in the through rate, and that the present published and filed rate for the service on the main lines only—that is, the service to the end of complainants' lines in Chicago, excluding the terminal service—is the same as it then was. The conclusion drawn is that because the carriers are now charging \$2 more than they once admitted was just and reasonable for the entire transportation, including the terminal service, the imposition of the terminal charge is a mere unwarranted addition to a just and reasonable charge, and is accordingly in itself unjust and unreasonable.

The logic of this argument is somewhat impaired by the concession that the carriers may, by reason of the trackage charge, ranging from 80 cents to \$1.50 per car, made by the Union Stockyard & Transit Company, add to the through rate the arbitrary sum of \$1 per car for a terminal charge. If the old through rate is not conclusive of the reasonableness of the terminal charge, it is obviously left open to every consideration affecting its reasonableness. Not only the trackage charge, but the other facts which create the complexity and affect the general cost of the terminal service referred to in the bill, should be considered.

The interstate commerce law confers the power upon carriers to determine for themselves the rate of freight between points on their lines and the terminal and other charges which they will make for services beyond their lines incident to transportation, and imposes upon them the duty of stating them separately in their schedules, which are required to be published for the information of patrons. Carriers may in this manner make such propositions for business as they please; but when they make them they must, until they are changed by themselves or by the commission, strictly observe them or suffer the pains and penalties of the law for disobedience. In the exercise of their power and obedient to their legal duty the carriers fixed and published the terminal charge in question for service beyond their lines rendered necessary to complete the transportation undertaken by them. They made this a separate matter, as they had the undoubted right under the law to do, and in our opinion neither the commission nor the courts have a right to complicate it with any other service in determining the reasonableness of a charge fixed for it.

The various provisions of the interstate commerce law requiring separate statements and schedules of all kinds of service and imposing

penalties for failure to observe them seem to us to necessarily place them apart and make each stand by itself when assailed as unlawful. This, of course, does not prevent consideration of all pertinent surrounding circumstances when any particular service is drawn in question.

It follows, we think, that the reduction of the terminal charge below its cost, or below its just and reasonable value, for the purpose of correcting the through rate, was erroneous. The commission, in our opinion, had no power, after the legal separation of the two services, to make the terminal charge unreasonably low, merely because the tariff for the through rate was unreasonably high. If the latter were true, the remedy was to reduce it by a direct proceeding instituted for that purpose, rather than by the indirection involved in reducing the charge for another connecting, but separate, service which was just and reasonable in itself. On the conceded facts of this case we think the commission misconstrued the law.

But it is argued that the power to prescribe maximum rates for service is conferred upon the commission exclusively; that when, in its opinion, an existing rate is unreasonable, the power to prescribe a maximum rate for two years to come arises; and, whether the opinion reached by the commission be right or wrong, that it is not under any circumstances reviewable by the courts.

With this contention we find ourselves unable to agree. As a result of the well-remembered, protracted, and able debates in Congress when the Hepburn bill was under consideration, concerning the question of a judicial review of the work of the commission, the following provisions were embodied in the act:

"Sec. 4. All orders of the commission except orders for the payment of money shall take effect within such reasonable time not less than thirty days and shall continue in force for such period of time not exceeding two years as shall be prescribed in the order of the commission unless the same shall be suspended or modified or set aside by a court of competent jurisdiction.

"Sec. 5. The venue of suits brought in any of the courts of the United States against the commission to enjoin, set aside, annul or suspend any order or requirement of the commission shall be in the district," etc., "and jurisdiction to hear and determine such suits is hereby vested in such courts: * * * Provided, that no injunction, interlocutory order or decree suspending or restraining the enforcement of an order of the commission shall be granted except on hearing after not less than five (5) days notice to the commission."

The defendant is a legislative commission, empowered to discharge certain legislative duties—among others, to determine and prescribe what are just and reasonable rates for carriers of interstate commerce to charge for the different kinds of service which they are authorized to perform for the public; that is, to determine and prescribe what may be the maximum of their charges for through transportation, terminal, storage, icing, and other services incidental to transportation, which they print or publish in their schedules, to be performed by them. Being a commission of the character mentioned, we at least perceive no reason for giving its proceedings and conclusions greater efficacy than is accorded to those of quasi judicial bodies, created to perform duties involving inquiry into facts and application of law thereto. The finding of facts on controverted and conflicting evidence by such

bodies, when not brought about by fraud or mistake, is generally conclusive, and ought not to be disturbed by the courts; but when facts found, conceded, or established without dispute admit of but one legal conclusion, and a different and erroneous one is reached by reason of a misconception and misapplication of law by such bodies, their action is subject to review, and may and ought to be avoided by the courts. *James v. Germania Iron Co.*, 46 C. C. A. 476, 107 Fed. 597; *Johnson v. Towsley*, 13 Wall. 72, 20 L. Ed. 485; *Moore v. Robbins*, 96 U. S. 530, 21 L. Ed. 758.

We refrain from expressing any opinion concerning what other jurisdiction, if any, is conferred upon this court by the broad and comprehensive language of the Hepburn act, authorizing it "to enjoin, set aside, annul or suspend any order or requirement of the commission." All we are required now to hold, and all we do hold, is that this court has ample jurisdiction to set aside or suspend any order of the commission resulting from a misconception and misapplication of a law to conceded or undisputed facts.

Applying the foregoing doctrine to the facts of this case, we think the learned commission fell into a mistake of law in attempting to correct the through rate by reducing the terminal charge itself below its just and reasonable value. That being a separable and separate service, actually segregated by proper action of the carriers from the rate over their main lines, it must, in our opinion, stand or fall upon its own merits, irrespective of whether the other rates are in themselves just and reasonable. If they are not just and reasonable, appropriate proceedings should be instituted to make them so. Such, we think, is the meaning of the Supreme Court expressed in the latter part of its opinion in *Int. Com. Comm. v. Chicago, etc., R. Co.*, supra. It there reserved the right to the commission "to commence proceedings to correct any unreasonableness in the rate resulting from the additional terminal charge," etc. If, by the separation of and separate charge for the terminal service, the balance of the rate from the origin of shipment to the stockyards is, in the light of former charges or for any other reason, too high, the remedy should be applied directly to it, without disturbing the rate, which is not too high.

Counsel for the commission again suggest, rather than seriously argue, we think, that no rate prescribed by the commission for any service can be set aside or suspended unless the complaining carriers make it appear that the enforcement of the rate challenged will render the business of the carriers throughout their whole line unprofitable. Our attention is called to the case of *St. L. & San Francisco Railway v. Gill*, 156 U. S. 649, 15 Sup. Ct. 484, 39 L. Ed. 567, as authority for this suggestion. Without stopping to analyze the Gill Case, to show its inapplicability to the case before us, or to consider the proposition advanced by counsel at any length, we content ourselves by saying that it seems utterly untenable. The provision of the interstate commerce law requiring carriers to segregate certain incidental services rendered by them from the principal service of transporting merchandise over the main lines of their roads, and requiring them to affix thereto a distinct and separate charge, which in itself must be just and rea-

sonable, is inconsistent with counsel's suggestion. We cannot conceive that Congress ever intended by the legislation in question to subject railroad companies to the necessity of an accounting concerning all their business throughout their entire lines, in order to secure proper compensation for an icing, elevating, or terminal service. An intention involving such an impracticable result should not be lightly imputed to Congress.

Some other arguments are made in support of the contentions of each side, all of which have received careful consideration; but, as the result reached by us necessarily follows from what has already been said, we refrain from prolonging this discussion further. The temporary injunction prayed for, suspending until the further order of this court the order of the commission reducing the terminal charge in question from \$2 to \$1, will be made; but we will require as a protection to shippers that the several complainants keep an accurate record showing the number of cars of live stock transported by them, respectively, over the terminal road in question to the Union Stockyards, together with the dates of such transportation, the names of the respective consignors and consignees, the charges made by the respective complainants for such terminal service, and the charges prescribed therefor at the time such service may be rendered by the Interstate Commerce Commission, and hold the same subject to such orders as this court may hereafter make with respect thereto. We shall also require that complainants furnish a bond, in the penal sum of \$100,000, conditioned that they will comply with the orders made upon them and pay such damages as shippers may sustain by reason of the injunction.

MISSOURI, K. & T. R. CO. et al. v. INTERSTATE COMMERCE COMMISSION.

(Circuit Court, E. D. Missouri. October 23, 1908.)

No. 5,646.

1. CONSTITUTIONAL LAW (§ 298*);—DUE PROCESS OF LAW—JUST COMPENSATION—REGULATION OF RAILROAD RATES IN INTERSTATE COMMERCE.

Neither Congress nor any legislative or administrative board acting by its authorization can competently establish rates for the transportation of property in interstate commerce that will not admit of the carrier earning such compensation for the service rendered as under all the circumstances is just and reasonable, since such action would deprive it of its property without due process of law, and would be a taking of its property for public use without just compensation, in violation of the fifth amendment to the Constitution.

[Ed. Note.—For other cases, see Constitutional Law, Cent. Dig. § 847; Dec. Dig. § 298.*

Interference with interstate or foreign commerce, see note to *McCanna & Frazer Co. v. Citizens' Trust & Surety Co. of Philadelphia*, 24 C. C. A. 13.]

*For other cases see same topic & § NUMBER in Dec. & Am. Digs. 1907 to date, & Rep'r Indexes

2. CONSTITUTIONAL LAW (§ 67*)—JUDICIAL POWERS—REASONABLENESS OF RAILROAD RATES.

Power to determine and prescribe what are just and reasonable maximum rates to be charged in interstate commerce is in a limited way conferred on the Interstate Commerce Commission by section 15 of the interstate commerce act (Act Feb. 4, 1887, c. 104, 24 Stat. 384 [U. S. Comp. St. 1901, p. 3165], as amended by Act June 29, 1906, c. 3591, § 4, 34 Stat. 589 [U. S. Comp. St. Supp. p. 900]); but as the commission acts only as a legislative or administrative board, and not judicially, its determination or action does not and cannot preclude judicial inquiry into the justness and reasonableness of the rates within the constitutional guaranty.

[Ed. Note.—For other cases, see Constitutional Law, Dec. Dig. § 67.*]

3: CARRIERS (§ 26*)—RATES PRESCRIBED BY INTERSTATE COMMERCE COMMISSION—REQUISITES TO LEGALITY.

Maximum rates prescribed by the Interstate Commerce Commission, to be just and reasonable within the constitutional limitation, must have reasonable regard for the cost to the carrier of the service rendered and the value of the property employed therein, and also reasonable regard for the value of the service to the public; and where the cost to the carrier is not kept within reasonable limits, or for any reason its business cannot reasonably be so conducted as to render it profitable, the misfortune must fall upon the carrier.

[Ed. Note.—For other cases, see Carriers, Dec. Dig. § 26.*]

4. CARRIERS (§ 32*)—RATES PRESCRIBED BY INTERSTATE COMMERCE COMMISSION—REQUISITES TO LEGALITY.

Rates prescribed by the Interstate Commerce Commission under the statute are not only required to be just and reasonable within the constitutional guaranty, but they must also not be unjustly discriminatory nor unduly preferential.

[Ed. Note.—For other cases, see Carriers, Dec. Dig. § 32.*]

5. COMMERCE (§ 91*)—JUDICIAL REVIEW OF ORDERS OF INTERSTATE COMMERCE COMMISSION—SCOPE OF INQUIRY.

Sections 15 and 16 of the interstate commerce act (Act Feb. 4, 1887, c. 104, 24 Stat. 384 [U. S. Comp. St. 1901, p. 3165], as amended by Act June 29, 1906, c. 3591, §§ 4, 5, 34 Stat. 589, 590 [U. S. Comp. St. Supp. pp. 900, 902]) confer on the Circuit Courts, sitting in equity, jurisdiction to entertain, hear, and determine suits to compel obedience to orders of the commission prescribing rates, and also of suits to annul or enjoin the enforcement of such orders. The scope of the inquiry in both classes of suits is the same, and the court is not confined to a consideration of the sufficiency of the facts as determined by the commission to sustain the order, but the hearing may be de novo, and may include the taking and consideration of evidence other than that before the commission; but the presumption is that the order is valid, and the burden is upon the party attacking it to make a clear case showing its invalidity.

[Ed. Note.—For other cases, see Commerce, Dec. Dig. § 91.*]

In Equity. On motion for preliminary injunction.

W. D. McHugh and J. W. Terry, for complainants.

P. J. Farrell and S. H. Cowan, for defendant.

Before VAN DE VANTER, HOOK, and ADAMS, Circuit Judges.

PER CURIAM. This is a suit in equity against the Interstate Commerce Commission by 49 railway companies and the receivers of 2 other railway companies to annul and enjoin the enforcement of an order of the commission requiring the railway companies to desist from exacting a terminal charge of \$2 per car for the delivery of

*For other cases see same topic & § NUMBER in Dec. & Am. Digs. 1907 to date, & Rep'r Indexes

live stock at the Union Stockyards, in Chicago, Ill., as respects shipments originating outside that state, and prescribing a maximum charge of \$1 per car for such terminal service, and also requiring the railway companies to desist from exacting the present through rates for transporting cattle in car loads from designated points in the Southwest to certain Northern ranges and to Chicago, Ill., National Stockyards, Ill., East St. Louis, Ill., St. Louis, Mo., St. Joseph, Mo., Kansas City, Mo., New Orleans, La., Omaha, Neb., and South Omaha, Neb., and prescribing for such through service certain maximum rates which are lower than the present ones. In the bill the order is assailed upon the grounds that both the terminal charge and the through rates prescribed therein are unreasonably low, noncompensatory, and confiscatory, and that the through rates are unjustly discriminatory and unduly preferential, in that they cannot be enforced without necessarily giving an undue and unreasonable preference and advantage to shippers of cattle and to cattle traffic, and also subjecting other shippers and other classes of traffic to a corresponding prejudice and disadvantage.

The matter for instant consideration is an application for a preliminary injunction suspending the enforcement of the order until the final hearing, and this application has been submitted upon the bill, the answer, divers affidavits, and some other written and printed proofs. It is conceded that the order was made by the commission upon a sufficient complaint, after due notice thereof to each of the railway companies and after a full hearing, in which they made a showing of substantially everything that they rely upon here. See *Cattle Raisers' Ass'n of Texas v. Missouri, Kansas & Texas Ry. Co.*, 11 Interst. Com. R. 296, s. c. 13 Interst. Com. R. 418. Shortly before the order was made, a preliminary injunction, suspending the enforcement of an earlier order containing a substantially identical requirement respecting the terminal charge at Chicago, had been granted by the Circuit Court of the United States for the District of Minnesota, after due notice and a full hearing, in a suit brought against the commission by several of the present complainants. That injunction was in full force when the order now before us was made (July 6, 1908) and served upon the railway companies (September 9, 1908), and it is still in full force. Because of this we felt constrained to suggest that the repetition of the prior order in the later one was a violation of the preliminary injunction in the other suit, and thereupon the commission, which seems not to have considered the matter in that aspect before, promptly rescinded so much of the later order as relates to the terminal charge. It will therefore be dismissed from further consideration.

We do not stop to enumerate the various contentions advanced by counsel in respect of questions pertaining to the through rates, but proceed to state briefly the conclusions at which we have unanimously arrived respecting the rules of law applicable to the case as now presented and respecting the proper disposition, upon the proofs submitted, of the application for a preliminary injunction.

1. Neither Congress nor any legislative or administrative board act-

ing by its authorization can competently establish rates for the transportation of property in interstate commerce that will not admit of the carrier earning such compensation for the service rendered as under all the circumstances is just and reasonable to it and to the public, for that would be depriving the carrier of its property without due process of law, and would be taking its property for public use without just compensation, in violation of the fifth amendment to the Constitution.

2. Power to determine and prescribe what are just and reasonable maximum rates to be charged in interstate commerce is, in a limited way, conferred upon the Interstate Commerce Commission by existing statute law; but as the commission acts only as a legislative or administrative board, and not judicially (*Western Union Telegraph Co. v. Myatt* [C. C.] 98 Fed. 335, 344), its determination or action does not, and cannot, preclude judicial inquiry into the justness and reasonableness of the rates, within the meaning of the constitutional guaranty, for that is a judicial question.

3. To be just and reasonable, within the meaning of the constitutional guaranty, the rates must be prescribed with reasonable regard for the cost to the carrier of the service rendered and for the value of the property employed therein; but this does not mean that regard is to be had only for the interests of the carrier, or that the rates must necessarily be such as to render its business profitable, for reasonable regard must also be had for the value of the service to the public. And where the cost to the carrier is not kept within reasonable limits, rier, as would be the case in any other line of business. or where for any reason its business cannot reasonably be so conducted as to render it profitable, the misfortune must fall upon the carrier, as would be the case if it were engaged in any other line of business.

4. Reasonably interpreted, the statute, by which alone the Interstate Commerce Commission derives its power, unmistakably requires that all rates prescribed thereunder shall be just and reasonable, within the constitutional guaranty, and also that they shall not be unjustly discriminatory or unduly preferential; and these requirements plainly operate as limitations upon the power of the commission.

5. The power conferred upon the commission is at most one that is merely regulatory of existing vested rights, and is therefore quite distinguishable from the powers conferred upon the General Land Office, the Pension Office, and other like departmental bureaus; for the latter are not engaged in administering laws which are regulatory of existing vested rights, but in executing laws relating to the disposal of the public lands of the nation, to the distribution of its bounty, and to other subjects in respect of which the power of Congress is not subject to the constitutional restrictions before named, but is sufficiently comprehensive to enable it competently to devolve the execution of such laws, including the final determination of all questions of fact, upon any agency it may select for the purpose.

6. The statute under which the Interstate Commerce Commission derives its power to prescribe rates at all unequivocally recognizes, and, if there be need therefor, it plainly declares, that the Circuit Courts,

sitting in equity, are vested with jurisdiction to entertain, hear, and determine suits to compel obedience to orders of the commission prescribing rates, and also suits to annul or enjoin the enforcement of such orders. This is shown (a) by the provision in section 15 (Act Feb. 4, 1887, c. 104, 24 Stat. 384 [U. S. Comp. St. 1901, p. 3165], as amended by Act June 29, 1906, c. 3591, § 4, 34 Stat. 589 [U. S. Comp. St. Supp. 1907, p. 900]) that "all orders of the commission, except orders for the payment of money, shall take effect * * * and shall continue in force * * * not exceeding two years, * * * unless the same shall be * * * suspended or set aside by a court of competent jurisdiction"; (b) by the provision in section 16 that when any carrier fails or neglects to obey "any order of the commission, other than for the payment of money," while the same is in effect, any party injured thereby, or the commission in its own name, may apply to the Circuit Court for an enforcement of such order, and "the court shall prosecute such inquiries and make such investigations, through such means as it shall deem needful in the ascertainment of the facts at issue, or which may arise upon the hearing of such petition"; (c) by the further provision in section 16 that "the venue of suits brought in any of the Circuit Courts of the United States against the commission to enjoin, set aside, annul, or suspend any order or requirement of the commission shall be in" designated districts, "and jurisdiction to hear and determine such suits is hereby vested in such courts"; and (d) by the still further provision in section 16 that the provisions of the expedition act (Act Feb. 11, 1903, c. 544, 32 Stat. 823 [U. S. Comp. St. Supp. 1907, p. 951]) "are hereby made applicable to all such suits, including the hearing on an application for a preliminary injunction, and are also made applicable to any proceeding in equity to enforce any order or requirement of the commission." It is not conceived that the scope of the inquiry which the court is authorized to make, or the effect to be given to the commission's finding or determination upon which its order is based, is intended to be in any wise different when the suit is one to annul or enjoin the enforcement of the order than when it is one to enforce obedience thereto.

7. It is not intended that the hearing in such a suit, whether it be of the one kind or the other, shall be confined to an ascertainment of what was determined by the commission and to a consideration of the sufficiency of the facts as determined by it to sustain the order; but, on the contrary, the hearing may be *de novo*, and may include the taking and consideration of evidence other than that before the commission.

8. Whether, if it should appear that in the proceedings before the commission the carrier declined or neglected fairly to avail itself of the opportunity to be heard in opposition to the order, the court, in the exercise of a sound discretion, ought to refuse to grant equitable relief to the carrier upon a showing which could have been, but was not, made before the commission, and ought to require that the same be first presented to the commission for its consideration, is a question which does not arise in this case, and it is mentioned now only to indicate that it is not decided by anything said herein.

9. In approaching the consideration of a case like this the court should start with the presumption that the order is valid, and was made after a careful consideration and a correct determination of every question of fact underlying it, and it should be accorded that respect and influence which ought to attend, and does attend, the action of a legislative or administrative board, whose members are in point of ability, learning and experience specially qualified to determine such matters. In short, the burden of showing that the facts are such as to render the order invalid rests upon the carrier assailing it, and unless the case made on behalf of the carrier is a clear one the order ought to be upheld.

10. In argument reference was made to the opinion in the suit to enjoin the enforcement of the earlier order relating to the terminal charge at Chicago (*Stickney et al. v. Interstate Commerce Commission*, 164 Fed. 638), and it was sought to ground upon that opinion an argument somewhat in conflict with some of the conclusions herein stated; but of that it is enough to say that that opinion, when read in its entirety and with due regard to the particular facts of that case, contains nothing which is in any wise in conflict with what is here said.

11. Applying what has been said to the case now before us, we hold that we may properly inquire whether the rates in question are just and reasonable, within the meaning of the constitutional guaranty, and whether they are unjustly discriminatory or unduly preferential, within the meaning of the statute, and that we may properly consider all of the evidence submitted by the railway companies, although some of it was not before the commission. Upon the evidence submitted we find that it tends in no inconsiderable degree to sustain some of the contentions of the railway companies upon subordinate questions of fact, and that it tends in a lesser degree to sustain other contentions, but that it is clearly wanting in that certainty, fullness, and persuasive force which ought to be, and is, essential to overcome the force of the commission's finding or determination upon which the order is based.

The application for a preliminary injunction is accordingly denied.

JOLINE et al. v. METROPOLITAN SECURITIES CO.

(Circuit Court, S. D. New York. October 14, 1908.)

TRIAL (§ 388*)—TRIAL BY COURT—SPECIAL FINDINGS.

In an action at law tried in a circuit court without a jury by stipulation under Rev. St. § 649 (U. S. Comp. St. 1901, p. 525), the defeated party is entitled to have the court make special findings of fact when it is doubtful under the decisions whether he could otherwise properly present to an appellate court the questions of law involved.

[Ed. Note.—For other cases, see *Trial*, Cent. Dig. § 908; *Dec. Dig.* § 388.*]

*For other cases see same topic & § NUMBER in *Dec. & Am. Digs.* 1907 to date, & *Rep'r Indexes*

Masten & Nichols (Joseph H. Choate, Arthur C. Masten, and Robert C. Beatty, of counsel), for plaintiffs.

Cravath, Henderson & De Gersdorff (Paul D. Cravath, Joseph C. Cotton, Jr., and Cortlandt P. Anable, of counsel), for defendant.

WARD, Circuit Judge. In this case, tried before me, a jury was waived in writing, and I have directed judgment to be entered for the plaintiffs. 164 Fed. 144. The defendant now requests me to make special findings of fact on the ground that under a general finding it will not be able to raise important questions of law if the case reaches the Supreme Court. On the other hand, the plaintiffs insist that these questions may be raised by exceptions to the refusal to dismiss the complaint on the merits and to the court's answers to propositions of law to be submitted. They say, further, that special findings should not be made because the judgment they have recovered will be imperiled on account of the difficulty of making findings that will pass muster in the courts. The relevant statutory (Rev. St.) provisions are:

"Sec. 649. Issues of fact in civil cases in any circuit court may be tried and determined by the court, without the intervention of a jury, whenever the parties, or their attorneys of record, file with the clerk a stipulation in writing waiving a jury. The finding of the court upon the facts, which may be either general or special, shall have the same effect as the verdict of a jury.

"Sec. 700. When an issue of fact in any civil cause in a circuit court is tried and determined by the court without the intervention of a jury, according to section six hundred and forty-nine, the rulings of the court in the progress of the trial of the cause, if excepted to at the time, and duly presented by a bill of exceptions, may be reviewed by the Supreme Court upon a writ of error or upon appeal; and when the finding is special the review may extend to the determination of the sufficiency of the facts found to support the judgment." (U. S. Comp. St. 1901, pp. 525, 570).

Justice Miller, in the case of *Norris v. Jackson*, 9 Wall. 125, 19 L. Ed. 608, formulated certain rules under the foregoing provisions, the relevant ones being:

(1) "If the verdict be a general verdict, only such rulings of the court in the progress of the trial can be reviewed as are presented by a bill of exceptions or as may arise on the pleadings."

(3) "That if the parties desire a review of the law involved in the case they may either get the court to find a special verdict which raises the legal propositions, or they must present to the court their propositions of law and require the court to rule on them."

The same views were expressed by Justice Blatchford in *St. Louis v. Rutz*, 138 U. S. 226, 11 Sup. Ct. 337, 34 L. Ed. 941; by Justice Brewer in *St. Louis Co. v. Western Union Telegraph Co.*, 148 U. S. 92, 13 Sup. Ct. 485, 37 L. Ed. 380, and *Lehnen v. Dickson*, 148 U. S. 71, 13 Sup. Ct. 481, 37 L. Ed. 373. On the other hand Justice Bradley in *Dirst v. Morris*, 14 Wall. 484, 20 L. Ed. 722, said:

"But as the law stands, if a jury is waived and the court chooses to find generally for one side or the other, the losing party has no redress on error except for the wrongful admission or rejection of evidence."

Justice Clifford in *Insurance Co. v. Folsom*, 18 Wall. 237, at page 253 (21 L. Ed. 827) said:

"Requests that the court would adopt conclusions of law were also presented by the defendants in the nature of prayers for instruction, as in cases

where the issues of fact are tried by a jury which were refused by the circuit court and the defendants also excepted to such refusals. None of these exceptions have respect to the rulings of the court in admitting or rejecting evidence, nor to any other ruling of the circuit court which can properly be denominated a ruling in the progress of the trial, as every one of the refusals excepted to appertain to some request made to affect or control the final conclusion of the court as to the plaintiff's right to recovery. Such requests or prayers for instruction, in the opinion of the court, are not proper subjects of exception in cases where a jury is waived and the issues of fact are submitted to the determination of the court."

And he said in *Cooper v. Omohundro*, 19 Wall. 65, at page 69 (22 L. Ed. 47), speaking of that case:

"Our decision in that case was that, in a case where issues of fact are submitted to the circuit court and the finding is general, nothing is open to review by the losing party under a writ of error except the rulings of the circuit court in the progress of the trial, and that the phrase 'rulings of the court in the progress of the trial' does not include the general finding of the circuit court nor the conclusions of the circuit court embodied in such general finding, which certainly disposes of the exceptions to the refusals of the circuit court to decide and rule as requested in the first four prayers presented by the defendant, as it is clear that these exceptions seek to review certain conclusions of the circuit court which are necessarily embodied in the general finding of the circuit court."

The last utterance of the Supreme Court is by Justice Shiras in *St. Louis v. Western Union Telegraph Co.*, 166 U. S. 388, 17 Sup. Ct. 608, 41 L. Ed. 1044, who, speaking of certain propositions of law which the trial court refused to make, said:

"The refusal of the court so to hold was excepted to and is assigned for error. But these were rulings which involved a determination of facts, and as those facts are not found for us by a special finding of the court, and as the evidence which developed the facts is not brought to our notice by exception to its competency or relevancy, no questions of law are presented for our review."

The Circuit Court of Appeals in the Fifth Circuit, in *Morris v. Canda*, 80 Fed. 739, 26 C. C. A. 128; of the Sixth Circuit, in *National Surety Co. v. R. R. Co.*, 145 Fed. 34, 76 C. C. A. 19; of the Seventh Circuit in *Streeter v. Sanitary District of Chicago*, 133 Fed. 125, 66 C. C. A. 190; and of the Eighth Circuit, in *Searcy County v. Thompson*, 66 Fed. 92, 6 C. C. A. 674—take the same view. I know that in this circuit Judge Blatchford, in *Clement v. Insurance Co.*, 7 Blatchf. 51, Fed. Cas. No. 2,882, and Judge Thomas in *Paul v. D., L. & W. R. R. Co.* (C. C.) 130 Fed. 951, affirmed by the Circuit Court of Appeals, 147 Fed. 51, 77 C. C. A. 315, held that questions of law could be raised on appeal either by exceptions to the refusal of a motion to dismiss or to the answers of the court to propositions of law.

Consideration of the decisions of the Supreme Court satisfies me that the defendant is justified in apprehending that its rights may be prejudiced if I make only a general finding, and I therefore think it fair to make special findings. Counsel for either party may submit findings within 10 days, bearing in mind that I can find only the ultimate facts.

THE WILLIAM B. KIBBEE.

(District Court, E. D. New York. November 4, 1908.)

COURTS (§ 524*) — CONFLICTING JURISDICTION — ADMIRALTY AND BANKRUPTCY COURTS.

Where a court of admiralty in a suit in rem acquired jurisdiction of the libeled vessel and the parties before the institution of bankruptcy proceedings against the owner in another district, and has sold the vessel and holds the proceeds, it can exercise its jurisdiction only so far as to determine the rights of the parties in admiralty, and any rights claimed under the bankruptcy law must be submitted to and determined by the court of bankruptcy having jurisdiction.

[Ed. Note.—For other cases, see Courts, Dec. Dig. § 524.*

Jurisdiction in admiralty as to matters of contract, see notes to The Richard Winslow, 18 C. C. A. 347; Norton v. The Richard Winslow, Id.; Boutin v. Rudd, 27 C. C. A. 530.]

In Admiralty.

Hyland & Zabriskie, for libellant.
Eugene D. Flanigan, for trustee.

CHATFIELD, District Judge. The libellant has an alleged claim for wages against the boat William B. Kibbee, which was owned by the Robinson-Baxter-Dissosway Towing & Transportation Company, a corporation now in bankruptcy under a petition filed in the United States District Court for the Northern District of New York. The libellant, previously to the filing of the petition in bankruptcy, had begun the present action in this district, and the boat had been seized by the United States marshal. Since that time it has been sold, and the proceeds are now in the registry of the court awaiting distribution. A number of other boats of this same company have also been seized and sold under libels in admiralty in this district, and in most of the cases there will be no surplus after the claim in admiralty is satisfied. In the case of the Kibbee some surplus may result. But the wages claim of Lown has been opposed in admiralty, by the trustee in bankruptcy, who contends that no maritime lien existed in favor of the libellant, and that any claim for wages must be presented in the bankruptcy proceedings in the Northern district of New York.

Under section 64b, par. 4, of the bankruptcy act (Act July 1, 1898, c. 541, 30 Stat. 562, 563 [U. S. Comp. St. 1901, p. 3447]), wages for a certain period are made preferred claims, and it has been held in the cases of *In re Tebo* (C. C.) 101 Fed. 419, and *In re Erie Lumber Co.* (D. C.) 150 Fed. 817, that wages claims are to be paid out of the bankruptcy estate ahead of all other liens except taxes. This court has now upon motion been asked to hold proceeds until the libellant, Lown, can have the question of his preferred claim in bankruptcy fully determined, in order that the proceeds from the sale of the vessel Kibbee in this court may be devoted to the payment of preferred liens in the bankruptcy court. Upon the making of the motion, the libellant was given an opportunity of immediately trying here the issues raised, if he wished to establish his alleged right to a maritime lien.

*For other cases see same topic & § NUMBER in Dec. & Am. Digs. 1907 to date, & Rep'r Indexes

This he did not do. There can be no question that the admiralty court has jurisdiction of the subject-matter, and jurisdiction of the persons concerned and of the issue involved, so far as the maritime lien is concerned, and that this jurisdiction was complete at the time the bankruptcy proceedings were inaugurated. This would bring the case within the doctrine of *Metcalf v. Barker*, 187 U. S. 165, 23 Sup. Ct. 67, 47 L. Ed. 122.

At the time the motion was argued, this court also said that the question of staying the proceedings in this court and of compelling the parties to the proceeding to transfer their disputes to the bankruptcy court could not be determined here, that the bankruptcy court alone was the one to determine what jurisdiction it had, and that this court could not be asked to do more than to exercise jurisdiction properly vested in it, when an issue was properly presented. The fact remains that, if the libelant here has not a good cause of action in admiralty, he may still be entitled to a preferred claim for wages; and if the United States District Court for the Northern District of New York in bankruptcy proceedings, or if the trustee in bankruptcy, or any of the creditors, desire to properly raise the question that the funds of the estate should be devoted to the payment of wages ahead of all maritime liens, then that question should be brought up in a proceeding where jurisdiction may be had over the various parties interested. This court having distinctly stated this proposition, and having stated that it is unwilling, as an academic question, to decide what ought to be done by other parties and other courts with reference to a fund which this court has jurisdiction to distribute, if the issues are brought to trial, there can be but one result: The present case in admiralty must be tried when reached, and in the meantime the fund must be held in the registry of this court.

If the libelant has doubt about having a maritime lien, and thinks that he has a preferred claim for wages in bankruptcy, he should bring the proper proceeding to protect the fund and bring it into the bankruptcy court. Such a result cannot be attained, nor those questions determined, in this action, which merely raises the question whether or not the claim of the libelant has the standing of a lien in admiralty.

UNITED STATES v. GRAHAM.

(Circuit Court, E. D. New York. November 10, 1908.)

ALIENS (§ 38*)—UNLAWFUL LANDING OF CHINESE—INDICTMENT.

An indictment charging the master of a vessel with having permitted a Chinese laborer to land in the United States from his vessel in violation of Act Sept. 13, 1888, c. 1015, § 9, 25 Stat. 478 (U. S. Comp. St. 1901, p. 1316), *held* to sufficiently negative the exceptions contained in section 10 of the act, where it averred that the said Chinese person was not landed by reason of "any necessity."

[Ed. Note.—For other cases, see *Aliens*, Dec. Dig. § 38.*

Importation of contract labor, see note to *United States v. Parsons*, 66 C. C. A. 133.]

*For other cases see same topic & § NUMBER in Dec. & Am. Digs. 1907 to date, & Rep'r Indexes

On Demurrer to Indictment.

William J. Youngs, U. S. Atty., and William P. Allen, Asst. U. S. Atty.

Convers & Kirlin (John M. Woolsey, of counsel), for defendant.

CHATFIELD, District Judge. The present indictment charges the defendant with having, on the night of the 8th of July, 1907, at South Brooklyn, in this district, knowingly, willfully, and unlawfully permitted to be landed in the United States, from a vessel of which the defendant was the master, a Chinese laborer and person of Chinese descent, being then and there an alien and a person not lawfully entitled to enter the United States. The indictment further charges that the said defendant had knowingly brought the said Chinaman as a part of his crew upon a trip of the steamer Dunottar to the port of New York as a port of destination, and also alleges:

"The said Jung Cow then and there not being compelled, and the said Thomas Graham then and there not being compelled, and he had not been so compelled, to allow the said Jung Cow to land by reason of any necessity; and no bond having been theretofore applied for and obtained, and no bond had been theretofore applied for and obtained, by any person for the temporary landing of the said Jung Cow from the authorities of the government of the said United States, as required by the statutes of the said United States and the regulations of the Secretary of Commerce and Labor of the said United States in force under said statutes."

The indictment contains allegations of other specific facts, but the portion of the indictment included in quotation marks recites all that is alleged with relation to the matters therein indicated. A demurrer has been interposed upon the ground that the provisions of the statute recite certain acts which would be otherwise included within the prohibition of the statute, but which are expressly excepted, and therefore not made offenses under the law; that, inasmuch as these acts not made criminal might be the basis or cause for the doing of any of the acts forbidden by the statute, an indictment must set forth in definite terms allegations showing that the offense charged does not come within the scope of the statutory exceptions.

The precise language of sections 9 and 10 of the act of September 13, 1888 (25 Stat. 478, c. 1015 [U. S. Comp. St. 1901, p. 1316]), so far as these sections affect this question, is as follows:

"Sec. 9. That the master of any vessel who shall knowingly bring within the United States on such vessel, and land, or attempt to land, or permit to be landed any Chinese laborer or other Chinese person, in contravention of the provisions of this act, shall be deemed guilty," etc.

"Sec. 10. That the foregoing section shall not apply to the case of any master whose vessel shall come within the jurisdiction of the United States in distress or under stress of weather, or touching at any port of the United States on its voyage to any foreign port or place. But Chinese laborers or persons on such vessels shall not be permitted to land, except in case of necessity, and must depart with the vessel on leaving port."

The attention of the court has been called to the decision of the demurrer in the case of *United States v. Wood* (D. C.) 159 Fed. 187, in which it has been held that the indictment was faulty, in that it did not allege that the acts charged to be criminal were outside

of the exceptions recited in the above statutes. With this decision this court entirely concurs. The exceptions are of such a character that not all landings of Chinese could be said to be criminal, and the indictment should describe the landing as it occurred, in definite form enough to bring it within the prohibition of the statute as limited by the exception.

We are not considering here the question of temporary shore leave by members of the crew (*Taylor v. United States*, 207 U. S. 120, 28 Sup. Ct. 53, 52 L. Ed. 130), but an actual landing in the United States, or negligence of such character as to be equivalent to permission to land with respect to Chinamen who are desirous of entering the United States as aliens, even though they come here as members of the crew of a vessel.

But in the indictment now under discussion the district attorney has alleged that the Chinaman who was permitted to land was not landed by reason of any necessity, and that no bond had been given for his temporary landing. Section 10 excepts from the provisions of section 9 the landing of Chinese in cases of necessity from vessels coming into the United States in distress or under stress of weather, or touching at a port on a voyage to a foreign port. The allegation of the indictment that the Chinese laborer was landed under no necessity is even broader than the exception of the statute, and, inasmuch as the indictment could not be required to go further than to negative the entire exception, it is impossible to see why this negation should be narrowed down, or the different particulars of the denial set forth, when every particular exception is covered by the broad statement used. In other words, the latter sentence of section 10 above quoted is the one which must be excluded from the acts charged, and, if so excluded, will cover the different provisions of the first part of the section.

The question of the ultimate departure of the Chinaman with the vessel, which is specified by the last clause of section 10, would, if complied with, be in mitigation of the offense, even if a landing had been permitted outside of the excepted cases, or may put an added obligation upon the master of the vessel. But the criminal offense is confined to the landing or permitting to be landed, and anything in mitigation of the offense certainly would not have to be pleaded as a part of the charge.

The indictment, therefore, would seem to be good, and the demurrer must be overruled.

THORNDYKE et al. v. ALASKA PERSEVERANCE MINING CO.†

(Circuit Court of Appeals, Ninth Circuit. October 5, 1908.)

No. 1,540.

1. APPEAL AND ERROR (§ 1009²)—REVIEW—FINDINGS IN EQUITY CASE.

The findings of the court in a suit in equity must be taken as presumptively correct, and, unless an obvious error has intervened in the application of the law or some serious or important mistake has been made in the consideration of the evidence, such finding will not be disturbed by the appellate court.

[Ed. Note.—For other cases, see Appeal and Error, Cent. Dig. §§ 3970-3978; Dec. Dig. § 1009.*]

2. WATERS AND WATER COURSES (§ 151*)—APPROPRIATION OF WATER FROM STREAM—ABANDONMENT.

Where an appropriator of water from a stream for use in developing mining claims owned by him at once commenced work necessary to take out and utilize the same, which he continued for four years and until he sold his property and rights to defendant, and during the next four years defendant continued the work in good faith, expending upward of \$500,000 in developing the mines, which were worked together as one property, building a stamp mill and boarding house and completing works by which the water was utilized to run the mill and supply the boarding house, there was not at any time such an abandonment of the water right as would authorize an adverse appropriation of the water by another at the end of that time, under the rules of the mining district which required a diligent and continuous prosecution of the work to completion.

[Ed. Note.—For other cases, see Waters and Water Courses, Cent. Dig. § 155; Dec. Dig. § 151.*]

Abandonment of water rights, see note to North American Exportation Co. v. Adams, 45 C. C. A. 190.]

Appeal from the District Court of the United States for Division No. 1 of the Territory of Alaska.

This suit was commenced to obtain a decree establishing the alleged right of the plaintiffs, by prior appropriation and use, to 1,000 miner's inches of the waters of a certain creek called "Lurvey Creek," and to enjoin the defendant from diverting any portion of the said 1,000 miner's inches, and for the recovery of \$5,000 as damages, and costs of suit; the plaintiffs basing their alleged right upon the alleged appropriation by the then plaintiff, V. McFarland, of the said 1,000 miner's inches of the waters of Lurvey creek pursuant to a notice in the complaint and herein set out, alleged to have been posted on the 24th day of July, 1905, by McFarland at a point about 700 feet from the junction of Lurvey creek with another creek, called "Gold Creek." The complaint also alleges that on the 19th day of June, 1905, McFarland, then being a citizen of the United States over the age of 21 years, located a certain specifically described placer mining claim called the "B. C. Fractional Placer Claim," in Silver Bow Basin, Harris mining district, near the town of Juneau, Alaska, and on the 27th day of the same month filed it for record with the recorder of the mining district, at the time of the location of which claim Lurvey creek flowed through it, carrying a volume of water, then unappropriated, varying from 600 to 1,000 miner's inches. The said notice is as follows:

"Notice of Appropriation of Waters.

"Notice is hereby given that the undersigned on July 24th, 1905, locates, appropriates, and claims 1,000 miner's inches of water of the waters of Lurvey Creek, in the Silver Bow Basin, in Harris Mining District, District of

*For other cases see same topic & § NUMBER in Dec. & Am. Digs. 1907 to date, & Rep'r Indexes

†Rehearing denied November 6, 1908.

Alaska, at the point where this notice is placed, which water is intended for use in mining and milling, and especially for use on the 'B. C. Fractional Placer' through which Lurvey Creek runs, at said point of diversion aforesaid. The said water is to be diverted and conveyed by means of a dam and flume or pipe-line, measured from the junction of Lurvey Creek with Gold Creek to the point of diversion whereon this notice has been posted as aforesaid, about seven hundred (700) feet up said creek in a southeasterly direction.

[Signed] Appropriator and Locator,

"V. McFarland.

"Witnesses:

"Frank S. Shelton.

"James W. Kelly."

The complaint alleges that the said notice of appropriation was on the 26th of August, 1905, duly filed for record with the recorder of the said mining district, and that on that date "the said V. McFarland did commence the construction of a dam in the bed of the said Lurvey creek at the point of location and appropriation aforesaid, and did thereafter, immediately and continuously, construct from said dam an intake and flume, and carry the said waters over and upon the 'B. C. Fractional Claim,' and thereon construct flumes and sluices for the retention and collection of gold mined upon said placer, and erect upon said placer a hydraulic giant and pipe, and with said waters begin the washing and mining of the said placer claim with the said waters. And the said waters were so appropriated for the purpose of said mining, hydraulicking, and washing the gold in said placer claim, and was necessary for its full volume and amount for that purpose, and ever has been so necessary, and is now so necessary. And that thereafter these plaintiffs, by mesne conveyances, became and now are co-owners with the said V. McFarland in the said water right location and appropriation." The complaint then alleges that after such location, appropriation, and diversion of the said waters, and while the plaintiffs were actually engaged in the use of the same for the mining and washing of the said placer ground, the defendant, without right, diverted the waters of the creek at a point above that of the plaintiffs' diversion, and carried them away from their natural channel by means of flumes, ditches, and pipe lines, to the plaintiffs' damage in the sum of \$5,000.

By its amended and supplemental answer, the defendant put in issue all of the material averments of the complaint, and as an affirmative defense set up that on and prior to the 2d day of July, 1897, one Joseph T. Gilbert was a citizen of the United States over the age of 21 years, and was the owner by location and purchase of six certain mining claims in Silver Bow Basin, near Juneau, Alaska, bordering upon and adjacent to a certain creek, and its tributaries, known as Lurvey creek, being the same Lurvey creek referred to in the complaint, which claims contained gold in paying quantities; that on the day last mentioned Gilbert went upon the public domain through which the creek flowed, at a point six or seven hundred feet below what is known as the "Lurvey Placer Claim," and then and there posted a notice of claim and appropriation of 4,000 miner's inches of the waters of the said creek, which waters were then unappropriated and unused, together with a right of way for a ditch, flume, and pipe line; that notice being as follows:

"Notice of Location Pre-empting of Right of Way for Ditch, Flume and Pipe Line and Location of Water.

"To whom these presents may concern, know ye, that I, Joseph T. Gilbert of Milwaukee, Wisconsin, a citizen of the United States, do hereby declare, and publish as a legal notice to all the world that I claim and have a valid right to the occupation, possession and enjoyment of all and singular that tract or parcel of land, lying and being in the Harris Mining District, District of Alaska, for the exclusive right of way for the purpose of constructing a ditch, flume, or pipe-line from Lurvey Creek to the Perseverance Mill site, U. S. Survey No. 68B, more particularly described as follows, to wit:

"Commencing at this notice a monument the same being erected at a dam in said creek and running thence:

"First course, N. 20 deg. 00' 151 feet, thence

"Second course, N. 47 deg. 30' W. 44 feet, thence

"Third course, N. 81 deg. 00' W. 126 ft., thence

"Fourth course, S. 20 deg. 15' W. 103 ft., thence

"Fifth course, S. 69 deg. 30' W. 75 ft.,

to the head of the pipe-line, thence by pipe N. 3 deg. 30' W. 1400 ft. horizontal measurement to the said mill site. I also claim and have valid right to 4000 miner's inches of water from said creek for mining purposes to be conveyed through said ditch and pipe to said mill site.

"Notice posted on the ground this 2d day of July, 1897.

"Joseph T. Gilbert,

"By Chas. W. Garside,

"Agent."

The answer alleges the recording of that notice on the 6th day of July, 1897, in Book 5 of Placers, in the recorder's office at Juneau, and that the said appropriation of the said water was made by Gilbert for the purpose of using the same in developing and working the said mining claims referred to in the answer, and that the whole amount of water so appropriated was necessary for that purpose; that the said mining claims constitute, with the mill sites in connection therewith, one entire mining property, and that the plan of development thereof then laid out contemplated the use of the said waters for the generation of power as well as all other mining purposes, and that the same was to be conveyed by ditch, flume, and pipe line to the mill to be erected as soon as the development of the mine should render the same expedient, and to the mine itself, boarding house, and wherever else the water should be needed, and that to that end Gilbert commenced, immediately after the posting and recording of the said notice, the construction of a dam in the bed of the creek at the point of appropriation mentioned, and immediately commenced the clearing of the right of way for the said ditch, flume, or pipe line referred to in the notice, and thereafter and continuously and with diligence proceeded with the construction of the said dam, intake, flume, ditch, and pipe line to carry said water to the said mill site, along the line described in the notice, a plat of which is attached to the answer. The answer alleges that Gilbert thereafter sold and conveyed, by good and sufficient deeds, all of his right, title, and interest in and to his said mining claims, mill sites, and water so appropriated and located by him, together with the right of way for the ditch, flume, and pipe line, and all of his improvements upon the said mining claims and mill sites, to the defendant, which deeds bear date April 22, 1902, and September 17, 1903, respectively, but that the defendant company went into the possession of all of the said property under an option to purchase prior to the execution of the deeds, to wit, about the 10th day of August, 1901, up to which date Gilbert continuously and with diligence prosecuted work upon his said mining claims and water rights, pipe and flume lines, and continued the development of his said mines, and that the defendant, after taking possession of the said property in 1901, and ever since that time, has continuously and with diligence continued to develop the said mining property so purchased from Gilbert, and other mining property which the company has since acquired adjacent thereto, and has continuously prosecuted its said work on said right of way for ditch, flume, and pipe line, from the point of the said intake on said Lurvey creek to the said mill site known as the "Perseverance Mill-site, U. S. Survey No. 68B," and has constructed and maintained continuously ditch, pipe, and flume lines conveying the said water from the dam and point of intake on Lurvey creek, and used the said water in connection with its boarding house, and air blast used in connection with running a large tunnel over 2,500 feet in length on its said property; and has continued its said improvements on the said property and mill site; has built a large boarding house for the purpose of accommodating its employes, exceeding 150 men; has constructed two large compressors, office buildings, stables, and outhouses, and completed a 50-stamp mill, the building being large enough for 50 stamps more, and ready to be equipped therewith, and has expended in all upon the said water rights, ditches, flumes and pipe lines, buildings and mill, over \$250,000, and has expended in development work on the said mining property so purchased from said Gilbert, and other mining claims adjacent thereto, but all of which is one common

property, over \$200,000 more, and that prior to July 24, 1905, the defendant had excavated a ditch line for the purpose of laying its water pipe to conduct the said water from said Lurvey creek to its said mill site, and had ordered and purchased pipe for the purpose of conveying the said water from the said creek to its said mill, which at said time was in the process of construction, and has continued the prosecution of its said work and completed the construction of its said flume and pipe line from said intake on said creek to said mill, and had, prior to said 24th day of July, 1905, diverted and appropriated the said water from said creek, and at all times had been in possession of the same and of the right of way so purchased from said Gilbert, and has used the said 4,000 miner's inches of water for hydraulic purposes and mining, and has turned it through the said flume and pipe and conveyed it to the said mill, and is ready to use the same for the purpose of generating power for the running and operation of the said mill and other purposes connected with its enterprise; that the defendant and its grantors have at all times since July, 1897, continuously maintained and used, and are entitled to maintain and use, the whole of the said 4,000 miner's inches of the water of the said Lurvey creek, and that the same will continue to be necessary to carry on, maintain, and operate the defendant's said mining and milling business, which operations cannot be carried on without the whole of the said water.

Replying to the affirmative answer and defense of the defendant, the plaintiffs allege that if it be true that on the 2d of July, 1897, or at any other time, Gilbert posted any notice of the intended diversion or appropriation of any of the waters of Lurvey creek, he and his successors in interest wholly failed to divert or to put to any beneficial use any of the said waters, and abandoned all right by virtue of such notice of appropriation or otherwise; that on the said 2d day of July, 1897, and ever since the year 1882, there was, and has been, in Alaska a mining district known as "Harris Mining District," within which the premises and rights in controversy here have been at all times embraced, in which mining district there has at all times been a recorder for the recording of mining claims and water-right notices and locations; that at a meeting of the miners of the district held in the year 1880 there was adopted and put into effect a code of local laws and rules governing the district and all persons therein, which rules were filed with the recorder for record, and were of record and in effect on July 2, 1897, by which local rules it was, among other things, provided:

"The right to use the running water flowing in a river or stream or down a cañon or ravine, may be acquired by appropriation. The appropriation must be for some useful and beneficial purpose, and when the appropriator or his successor in interest ceases to use it for said purpose the right ceases.

"As between appropriators, the one first in time is the one first in right.

"A person desiring to appropriate water must post a notice in writing in a conspicuous place at the point of intended diversion, stating therein:

"First: He claims the water there flowing to the extent of (giving the number) inches, measured under a four-inch pressure:

"Second: The purpose for which he claims it and the place of intended use. A copy of the notice must within (10) days after it is posted be recorded in the books kept by the recorder of the district.

"Within twenty days during the working season after the notice is posted the claimant must commence the excavation or construction of the works in which he intends to divert the water, and must prosecute the work diligently and uninterruptedly to completion unless temporarily interrupted by rain or snow.

"By completion is meant the conducting of the water to the place of intended use.

"By a compliance with the rules above-named the claimant's right to the use of the water relates back to the time that the notice was posted.

"A failure to comply with such rules deprives the claimant to the right to the use of the water as against a subsequent claimant who complies therewith."

The reply of the plaintiffs further alleges that Gilbert and his successors in interest wholly failed to comply with any of the requirements of the said

local rules, by reason of which he and they abandoned and lost any right to said waters that they may have had.

In respect to the local rules and regulations set out in the plaintiff's reply, the court below found that they "fell into utter disuse before the rights of either of the parties to this action were claimed to have been initiated, and that the same are inconsistent with the general laws of the United States, and are therefore of no effect in the determination of the issue in this case": and, further, "that prior to the year 1884 the miners of Harris mining district adopted rules governing the appropriation of water on public lands for mining purposes, and ever since that act the miners through the various camps in Alaska, and particularly Harris mining district, have conformed to the custom of posting notices and declarations of water rights, and the recording of the same, and the water from public streams has been diverted and used for mining and other beneficial uses, and such was the custom at the time of the initiation of defendant's rights herein and the commencement of this action, and down to the present time," which said subsequent local rules are set out in the findings as follows:

"Article 1. The right to use the running water flowing in a river or stream, or down a canyon or ravine, may be acquired by appropriation.

"Art. 2. The appropriation must be for some useful or beneficial purpose, and when the appropriator or his successor in interest ceases to use it for such purposes, the right ceases.

"Art. 3. The person entitled to the use may change the place of diversion if others are not injured by such change, and may extend the ditch, flume, pipe or aqueduct by which the diversion is made to take place beyond that where the first use was made.

"Art. 4. A water appropriation may be turned into the channel of another stream and mingle with its waters and then reclaimed, but in reclaiming it the water already appropriated by another must not be diminished.

"Art. 5. As between appropriators, the one first in time is the first in right.

"Art. 6. A person desiring to appropriate water must post a notice in writing in a conspicuous place at the point of intended diversion, stating herein: First, he claims the water there flowing to the extent of (giving number) inches, measured under six-inch pressure; second, the purpose for which he claims it and the place of intended use. A copy of the notice must within (10) days after it is posted be recorded in the books kept by the recorder of the district.

"Art. 7. Within twenty days, during the working season or construction of the works in which he intends to divert the water, and must prosecute the work diligently and uninterruptedly to completion, unless temporarily interrupted by rain or snow.

"Art. 8. By completion is meant conducting the waters to the place of intended use.

"Art. 9. By a compliance with the above rules, the claimant's rights to the use of the water relates back to the time the notice was posted.

"Art. 10. A failure to comply with such rules deprives the claimant of the right to the use of the water as against a subsequent claimant who complies therein."

There was a large amount of evidence introduced on behalf of the respective parties upon the trial, upon which the court below made specific findings of fact, and much of which was specifically considered by the court in an elaborate opinion, also found in the record.

G. C. Israel, J. A. Hellenthal, L. R. Gillette, Lorenzo S. B. Sawyer, R. F. Laffoon, and Winn & Burton, for appellants.

Malony & Cobb, W. C. Sharpstein, and Frank M. Stone, for appellee.

Before GILBERT, ROSS, and MORROW, Circuit Judges.

ROSS, Circuit Judge (after stating the facts as above). From the pleadings of the parties we think it clear that no question of riparian

rights arises in the case, all of them basing their alleged rights on their alleged respective appropriations of the public waters for mining, and other purposes connected therewith.

The exhibits and other evidence in the case show that Silver Bow Basin is a small pocket surrounded by high mountains, upon some of which are located the defendant's lode mining claims—its mill, mill sites, buildings, and other improvements of that character being situated in the basin. Above the basin Lurvey creek forks, what is known as North or East Lurvey creek coming into the main stream at a point on what is now the defendant's Solo lode claim. It appears that in this basin placer ground was worked by miners many years before the rights of either party to this controversy were initiated, and that in their operations those former miners used the water of both branches of Lurvey creek, bringing that from the North or East creek to the main stream by means of a ditch or flume.

The trial court found, among other things, that on and prior to July 2, 1897, Joseph T. Gilbert was the owner, by location and purchase, of a group of seven lode mining claims, called respectively the "Perseverance," "Alta," "Jumbo," "Rimrock," "Perseverance No. 2," "Alta No. 2," and "Jumbo No. 2," and a group of four mill sites, namely, the Ajax, Rimrock, Alta, and Perseverance, all situated in Silver Bow Basin; that the lode claims lie high upon the mountains, and the mill sites in the valley below; that Lurvey creek flows over and across that group of claims, and tumbles down the mountain and unites with Gold creek within the boundaries of the Ajax mill site; that the ground over which Lurvey creek flowed on its course from the lode claims mentioned to the said mill sites was, on the 2d day of July, 1897, unappropriated and unoccupied; that on said 2d day of July, 1897, the said Gilbert, at a point on Lurvey creek where was the dam of the old miners, and at an altitude of about 800 feet above the mill site, located what is called in the record the defendant's Lurvey creek water right, claiming 4,000 miner's inches of the water of the said creek, and located and surveyed the right of way for a ditch, flume, and pipe line from the said old dam, across unappropriated government land, to said mill sites below, and posted his location notice at the dam, on land at the time unappropriated and unpossessed by any one, and on the 6th day of July, 1897, recorded the said location notice with the recorder of the district; that at the time of the posting of that notice and of its recordation the waters of Lurvey creek were unappropriated, and were so appropriated by Gilbert for use in the development and operation of his said mining properties, to be conveyed to the mines and mill sites by ditch, flume, and pipe, for power and other purposes; that immediately thereafter Gilbert commenced the development of his said mining claims by driving tunnels and crosscuts at what is now called the "Gilbert Tunnel and upper workings," and at the same time commenced the reconstruction of the old dam and the old ditch referred to as having been used by the former miners, and continued such development during the working season of each year thereafter until the close of 1899, when he completed the ditch to the penstock above the said mill site, and excavated for the pipe line from the penstock to the said mill site, and

as early as October, 1897, had the water flowing in the said ditch and turned out at the old spillway and over the "Little Falls" which are about midway between the mill sites and the intake on Lurvey creek; that Gilbert appropriated the said water in good faith and for the purpose of applying the same for the beneficial uses stated, and continued actual work on his said mines and water rights and locations, and prosecuted the same with diligence to the year 1901, at which time he sold his said mines, mill sites, water, water rights, and all improvements made thereon to one W. J. Southerland under a contract or option to purchase, who thereafter sold and assigned the option and contract to purchase to the defendant company, which company entered into possession of the whole of the said properties, water rights, and improvements in August, 1901, and thereafter complied with all the terms and conditions of the contract of purchase, and received from Gilbert a good and sufficient conveyance of all of the said mining properties, water, water rights, and improvements, since which time the defendant has been the owner thereof; that upon the defendant's acquiring the properties in August, 1901, it commenced to repair the ditch and dam, and laid out and commenced the driving of a tunnel in and through the said mining properties known as the "Alexander Tunnel," having its entrance about 275 feet above the said mill site, and extended the tunnel about 2,550 feet into the mountain, cutting the ore bodies at a depth of about 1,000 feet below the Gilbert tunnel, and far below the apex of the ore bodies; that in 1902, and while the defendant was driving the Alexander tunnel, the water from Lurvey creek was carried through the said ditch, spilled over the spillway into a canyon below the aforesaid "Little Falls," where it was caught and conveyed by pipe to the blacksmith shop of the defendant company and used therein, and in 1903, during the development of the said mining claims and water rights, the said water was extended to and used in the boarding house of the defendant company, and down an air shaft of the Alexander tunnel for the purpose of ventilation; that in the latter part of April, and in the early part of May, 1905, the defendant commenced the excavating for the foundation of a large boarding house, crusher house, compressor house, and for a 100-stamp mill, the ground being laid out for a 300-stamp mill, and also of a trench for the pipe line from the mill to the penstock at the old ditch, and continued such work with reasonable diligence, and on August 1, 1905, a new boarding house was completed and in use by the defendant, with the said water from Lurvey creek therein for domestic and fire purposes, and a foundation for the crusher house, and the trench for the pipe line were completed, and the material on the ground for the construction of the crusher house and the new flume from the dam from the penstock sluice, and much of the material for the construction of the mill; that by the latter part of October, 1905, the pipe line had been laid from the mill to the south corner of what is known as the "Perseverance Placer Claim," a new flume completed from both the main and east branches of Lurvey creek to the penstock at the head of the pipe line, and the said water turned into it and discharged at the spillway and passed down into the ravine, as it had done theretofore, and from the old ditch, where

it was gathered up for said uses; that in April and May, 1906, the pipe line was completed to the penstock, and the said water turned into it, and used at the mill and for hydraulic purposes, and during that year a mill was completed of sufficient size and dimensions to accommodate 100 stamps, and to this extent the scheme and plan of development laid out and started by the said Gilbert in 1897 was completed; that during the period of time mentioned government patents were issued to all of the aforesaid mining property, together with certain other properties located by the defendant, to wit, Perseverance No. 5, Perseverance No. 6, and Ethel fraction lode claims, and the Perseverance placer, all contiguous to the before-mentioned properties deeded to the defendant by Gilbert; that during the same period of time the defendant company completed an upraise from a point near the end of the Alexander tunnel a vertical distance of 920 feet, and ran many drifts and levels and completed other underground works, all for the successful mining and operation of the said property, at a cost in excess of \$500,000; that on or about June 19, 1905, and while the defendant company was so actively engaged in its development work, the plaintiff V. McFarland located the B. C. fraction placer claim alongside the Perseverance placer, a small part of which B. C. fraction placer was unoccupied ground, and over which Lurvey creek flows for about 200 feet before entering the said Perseverance placer grounds; that all of the water so located and claimed by the defendant company and not used by it during the said period of development continued to flow down Lurvey creek and across said B. C. fraction claim located by the said McFarland, and that under his claim of 1,000 miner's inches of the waters of the said Lurvey creek he did on the 26th day of August, 1905, commence the construction of a dam and intake and flume, by means of which he proceeded to do some ground sluicing on ground embraced within a prior placer location claimed by the defendant company, called the "Martin Lode Claim," over which the B. C. fraction lapped, but that no clean-up was made and no gold was obtained therefrom of any consequence; that there is only from one-eighth to one-half of an acre of the B. C. fraction claim that is not in dispute, and that could be successfully worked or sluiced by the water taken from Lurvey creek at the plaintiffs' intake; that the location and attempted appropriation of the said water by the plaintiffs was not in good faith or for any beneficial purpose, and was not intended to be used by them for any such purpose.

Should it be conceded that Gilbert did not follow up his appropriation by work with sufficient diligence to have enabled him to hold the water as against any adverse appropriation made prior to his sale to the defendant, it would not help the plaintiffs, since the appropriation under which they claim was not made until July 24, 1905—several years after the defendant company acquired all of the properties from Gilbert. Certainly the evidence affords no just ground for saying that from the time of the defendant's purchase in 1903 it did not prosecute the work diligently. It shows that the defendant got many of its claims, and one or more of its mill sites, patented by the government, and that from the very inception of the undertaking the plan was to develop and operate all of them as one property; that it

drove one tunnel 2,550 feet into the mountain to cut its various ledges, made one upraise of 920 feet, built one 50-stamp mill, with room and building space enough for an additional 50 stamps; that it built the necessary houses for its large operations, cleaned out the ditches, repaired the flumes, excavated for and constructed pipe lines, and continuously used by means of them, in the progress of the work, such of its appropriated waters of Lurvey creek as were from time to time needed. Evidence was also given on behalf of the defendant to the effect that all of the 4,000 inches appropriated by its assignor, Gilbert, are needed by the company for power and other necessary uses in its said operations, and that in the aggregate it and its assignors have already expended in the establishment and development of the property about \$500,000.

Whatever conflict there is in the evidence was resolved against the plaintiffs by the judge of the court below, whose findings are in cases like the present always to be taken as "presumptively correct, and unless an obvious error has intervened in the application of the law, or some serious or important mistake has been made in the consideration of the evidence, the findings should not be disturbed" *North American Exploration Co. v. Adams*, 104 Fed. 404, 45 C. C. A. 185; *Tilghman v. Proctor*, 125 U. S. 136, 8 Sup. Ct. 894, 31 L. Ed. 664; *Kimberly v. Arms*, 129 U. S. 512, 9 Sup. Ct. 355, 32 L. Ed. 764; *Furrier v. Ferris*, 145 U. S. 134, 12 Sup. Ct. 821, 36 L. Ed. 649. So far from finding any such mistake in the present case, we are of the opinion that the evidence clearly justified the findings made by the court below.

The judgment is affirmed.

BOLEN-DARNALL COAL CO. V. WILLIAMS.

(Circuit Court of Appeals, Eighth Circuit. October 23, 1908.)

No. 2,717.

1. TRIAL (§ 242*)—INSTRUCTIONS—FAILURE TO INSTRUCT ON MATERIAL ISSUES.

Instructions which, taken as a whole, are calculated to mislead the jury as to the character of the evidence necessary to prove the issue on one side, as by failing to present with sufficient distinctness a material fact which may have a controlling effect, are erroneous.

[Ed. Note.—For other cases, see *Trial*, Cent. Dig. §§ 572, 573; *Dec. Dig.* § 242.*]

2. TRIAL (§ 253*)—INSTRUCTIONS—MISLEADING INSTRUCTIONS.

In an action in the Indian Territory by a coal miner against the mining company to recover for a personal injury, it was alleged that the injury was caused by the negligence of defendant in permitting great quantities of inflammable coal dust to accumulate in the mine in violation of Act July 1, 1902, c. 1356, 32 Stat. 631, which provides that "whenever it is practicable to do so the entries, rooms, and all openings being operated in coal mines shall be kept well dampened with water to cause the coal dust to settle, and that when water is not obtainable at reasonable cost for this purpose accumulations of dust shall be taken out of the mine. * * *" *Held*, that substantial evidence introduced by defendant tending to show that the mine was kept dampened with water and

*For other cases see same topic & § NUMBER in *Dec. & Am. Digs.* 1907 to date, & *Rep'r Indexes*

that the slope in which the injury occurred was at the time well dampened raised a material issue, since in such case defendant was not negligent under the statute in permitting dust to accumulate, and that instructions which ignored such issue and permitted plaintiff to recover on a finding alone that dust was permitted to accumulate and that its explosion caused the injury were misleading and erroneous.

[Ed. Note.—For other cases, see Trial, Cent. Dig. §§ 613–617; Dec. Dig. § 253.*]

3. MASTER AND SERVANT (§ 205*)—CONDITION OF MINE—ASSUMPTION OF RISKS.

The law imposes upon a mine owner the duty of exercising reasonable care to see that the mine is in a reasonably safe condition for an employé to work therein, and does not require the employé to exercise care to discover its condition before going to his work.

[Ed. Note.—For other cases, see Master and Servant, Cent. Dig. §§ 547–549; Dec. Dig. § 205.*]

4. TRIAL (§ 237*)—INSTRUCTIONS—REFUSAL OF REQUESTS.

A requested instruction in an action based on negligence that the negligence of defendant must be “absolutely” shown to warrant a recovery was properly refused as stating an excessive measure of proof.

[Ed. Note.—For other cases, see Trial, Cent. Dig. § 548; Dec. Dig. § 237.*]

In Error to the United States Court of Appeals in the Indian Territory.

For opinion below, see 104 S. W. 867.

S. Guerrier, for plaintiff in error.

Harley & Lewis, for defendant in error.

Before SANBORN and HOOK, Circuit Judges, and PHILIPS, District Judge.

PHILIPS, District Judge. This is an action for personal injury resulting from an alleged explosion in a coal mine, with verdict and judgment for the plaintiff below for \$12,500. This judgment was affirmed by the Court of Appeals of the Indian Territory.

The defendant in error (hereinafter designated the plaintiff) was working in the east entry on the seventh level of the mine. Just after he had fired his last charge for the day and was passing out up the level, a flame came up from below, overtaking and burning him severely. There are multiplied acts of negligence imputed in the petition to the defendant company as the cause of the injury. As it is apparent from the trial, the charge of the court and the briefs of the respective counsel, that the recovery was had upon one specified ground, it would subserve no practical end to discuss other allegations of the petition. This specification is as follows:

“That defendant company carelessly and negligently permitted great quantities of inflammable coal dust to accumulate on the main slope in the said entry and in the seventh east entry, and at and near the face of the main slope in said mine, which said inflammable coal dust became ignited, in some manner to plaintiff unknown, causing plaintiff to receive the injuries hereinafore and hereinafter set out.”

In support of its action the plaintiff below invoked the act of Congress approved July 1, 1902, c. 1356, 32 Stat. pp. 631, 632, which declares that:

*For other cases see same topic & § NUMBER in Dec. & Am. Digs. 1907 to date, & Rep'r Indexes

"Wherever it is practicable to do so, the entries, rooms, and all openings being operated in coal mines, shall be kept well dampened with water to cause the coal dust to settle, and that when water is not obtainable at reasonable cost for this purpose accumulations of dust shall be taken out of the mine, and shall not be deposited in way places in the mine where it would be again distributed in the atmosphere by the ventilating currents."

As the evidence showed, without dispute, that there was abundant water obtainable for the purpose indicated in the foregoing statute, and that the defendant did use the water therefor, the natural meaning of the statute is that although there may have been accumulations of dust in said mine, yet if the owner kept the same well dampened with water to cause the dust to settle, it had performed its duty under the statute, and was not liable from the mere fact of the accumulation of coal dust in the mine.

In *Cherokee & P. Coal & M. Co. v. Wilson*, 47 Kan. 460, 28 Pac. 178, the court said:

"The explosiveness of coal dust is an open and unsettled question, and, in an action to recover for injuries resulting in a coal mine, the court will not take judicial notice that dry, fine coal dust is a dangerous and explosive element."

It being a disputed and open question among expert miners and in scientific treatise on the subject whether or not coal dust in a mine is inflammable, Congress, without determining such question, evidently intended by the foregoing enactment to minimize the danger from the presence of such accumulated dust by requiring its removal, or that the mine owner should keep it well dampened with water to cause the dust to settle; the thought doubtless being that the danger of ignition or the deleterious effect of such dust was to be apprehended from the particles being distributed in the atmosphere, and that this could be measurably prevented by dampening the deposits of such dust.

It was, therefore, an important issue of fact in this case, after proof tending to show that there was an accumulation of coal dust along the tracks of the tramway and on the slope—a condition inseparable from such mining operations—whether or not the mine owner observed the statute in respect of dampening the dust with water. The evidence showed that the water supply was near the fourth level of the mine. It was taken therefrom in a box on a water slide containing about 60 cubic feet in measurement, say 449 gallons of water. This box when brought to the level was dropped by a rope attached thereto down the slopes and the entries. There was a pipe encircling the ends of the box to throw the water outside of the rails of the track. The box being six feet long, the water, as stated by a witness, in its sprinkle or spray would cover eight inches beyond the ends of the box. In other words, it would sprinkle a width of seven feet four inches; the width of the slope generally being about seven feet, and in places where there was a dip it might be nine feet wide. The evidence was that the distance from the fourth level to the bottom of the lowest level was about 400 feet. From the sixth to the seventh level the witness who did the watering testified that the "lifts were a hundred feet"; and from the seventh down to the face of the slope it was "about one hundred and a quarter"—that is, 125 feet. He further testified

that he turned the box of water loose "about thirty or forty feet below the sixth" (level). He also testified that on previous days he watered the slope once or twice extra, whenever he thought it needed it. How much of this water reached the bottom of the slope is not definitely known. The witness Wilburn, fire boss of the mine at the time, testified that the slopes in the mine the day preceding the explosion were damp; that it was his duty to see that the mine was kept in a safe condition in all respects, and that on the day preceding the accident the slope was in safe condition. Mr. McLean, who was superintendent of the mine at the time, testified that he examined the mine on the day before the accident; that the slope was in fair condition in respect of its wetness on the night previous to the explosion; and that they tried in every respect to keep the mine moistened at all times, and it was the duty of the night men to sprinkle; that on this special occasion the man Martin, the first witness above referred to, was assigned to this duty. Regardless, therefore, of any other testimony, pro or con, touching this issue as to whether or not the fire originated from combustion of coal dust, there was amply sufficient evidence to entitle the defendant to the judgment of the jury as to whether or not it kept the mine well dampened with water to cause the coal dust to settle, and whether or not its failure, if any, in this duty was the proximate cause of the injury. The charge of the court to the jury in this respect was as follows:

"If you find by a preponderance of the weight of the testimony that the defendant was negligent by permitting dust to accumulate in its mine in this slope, * * * as complained of by the plaintiff, and by reason of the negligence of the company this coal dust accumulated there, and that it was the cause of the explosion, then the plaintiff should recover of the defendant on account of that negligence in such an amount as the evidence shows he has been injured by reason of this negligence," etc.

Nowhere in the charge did the court submit to the jury the question of fact as to the dampening of the coal dust with water. But, in effect, it told the jury that if the coal dust was suffered to accumulate, and that caused the injury, they should find a verdict for the plaintiff no matter what they might think about the sufficiency of the dampening of the dust. It hardly needs the citation of authorities to maintain that it was palpable error, under such circumstances, to thus ignore in its charge one of the principal issues involved in the defense and supported by evidence. Suppose the jury had returned a verdict for the defendant on the ground that it had not failed of its duty in keeping the coal dust dampened with water; could it be successfully maintained that the verdict should be set aside on the ground that there was no evidence to warrant it?

"Instructions which, taken as a whole, are calculated to mislead the jury as to the character of the evidence necessary to prove the issue on one side, are erroneous. *Rea v. Missouri*, 17 Wall. 532-543, 21 L. Ed. 707. Reversible error exists if the general effect of a charge tends to withdraw from the consideration of the jury material evidence. *Hall v. Weare*, 92 U. S. 728, 23 L. Ed. 500. If an instruction fails to present with sufficient distinction a material fact which may have a controlling effect, there is ground for reversal. *Ayers v. Watson*, 113 U. S. 594, 609, 5 Sup. Ct. 641, 28 L. Ed. 1093. It is error for the court to submit the evidence and theory of one party prominently and fully to the jury and not call their attention to the main points

of the opposite party's case. *Canal Co. v. Harris*, 101 Pa. 80; *Reichenbach v. Ruddach*, 127 Pa. 564, 595, 18 Atl. 432; *Young v. Merkel*, 163 Pa. 513-520, 30 Atl. 196." *Weiss v. Bethlehem Iron Company*, 88 Fed., loc. cit. 30, 31 C. C. A. 363, 370.

Error is assigned of the action of the court in refusing to give certain instructions requested by the defendant below. One of these asserted the proposition that if the plaintiff knew, or could have known by the exercise of ordinary care and prudence, the condition of the mine or the part thereof which was the alleged cause of the explosion, then, knowing the defects complained of, he assumed the risks thereof and cannot recover. This request was properly refused. The law did not impose upon the plaintiff the duty of exercising care and prudence to discover the condition of the mine before going to his work. On the contrary, the law, as well as the federal statute hereinbefore mentioned, imposed upon the mine owner the duty of exercising reasonable care to see that the mine was in a reasonably safe condition for the servant to work therein. If the defective or dangerous condition, if any, was so obvious to the eye of the servant at the time and place as to make it apparently dangerous to work there, and he voluntarily saw fit to so work, without complaint, it might be said that he assumed the risk; and the court in its charge gave the defendant the full benefit of this declaration of law.

An instruction refused by the court, which is assigned for error, is as follows:

"Before the plaintiff can recover at all, he must show the proximate cause of the accident. The burden of proof is entirely upon the plaintiff to show such proximate cause, and also to show that said proximate cause existed by or through the negligence of the defendant company, and, unless this is clearly and absolutely shown, the plaintiff cannot recover."

The vice of this request was the employment in the instruction of the word "absolutely." This imposed a condition beyond the requirements of the law, and justified the rejection of the whole request.

Other requests for instructions by the defendant respecting the burden resting upon the plaintiff to show the proximate cause of the injury were fully enough expressed by the charge of the court.

As suggested at the outset of this opinion, in view of the fact that in their last analysis the various grounds of negligence alleged in the petition were reduced on the trial to one or more very simple issues of fact and law, it can subserve no useful purpose to discuss the various objections made by the defendant to certain specifications of the petition. And inasmuch as the judgment must be reversed and the cause remanded for new trial, other matters complained of in respect of questions to and answers by witness are not deemed of sufficient importance to demand discussion, and the errors, if any, may not be repeated on a further trial.

Under the facts and circumstances disclosed by this record, there being neither wantonness nor reckless negligence on the part of the defendant, we cannot refrain from expressing the view that the amount of the verdict awarded by the jury seems to be excessive; so much so as to give color to the impression that there was present in the mind of the jury an element of passion or prejudice. The responsibility of

correcting such abuse by the jury, however, rests upon the trial court, to see to it that justice does not miscarry, by presenting to the plaintiff in such instance the alternative of entering a reasonable remittitur or to submit to a new trial.

For the reasons hereinbefore stated, the judgment of the United States Court for the Indian Territory and the judgment of affirmance by the Court of Appeals thereof must be reversed, with directions to grant a new trial, and the cause remanded to the Supreme Court of the State of Oklahoma for further proceedings in accordance with law.

LIGON et al. v. JOHNSTON et al.

(Circuit Court of Appeals, Eighth Circuit. September 30, 1908.)

No. 2,685.

INDIANS (§ 15*) — DISPOSITION OF INDIAN LANDS — CHOCTAW AND CHICKASAW GRANT—POWER OF CONGRESS.

The land granted by the United States to the Choctaw Nation March 23, 1842, "in fee simple to them and their descendants to inure to them while they shall exist as a nation and live on it," pursuant to the treaty of September 27, 1830 (7 Stat. 333) in which land the Chickasaw Nation obtained an interest in common with the Choctaws by a treaty between them made January 17, 1837 (11 Stat. 573), became public land of the two nations and not the property of their individual members, and the disposition of such lands as tribal property was within the domain of Congress, whose action in that regard by Act April 26, 1906, c. 1875, 34 Stat. 137 (U. S. Comp. St. Supp. 1907, p. 867), which provided for individual allotments, the disposition of unallotted lands, and the distribution of the proceeds between members of the tribes as shown by an enrollment to be completed and approved by March 4, 1907, is conclusive upon the courts, which have no power to revise such enrollment.

[Ed. Note.—For other cases, see *Indians*. Cent. Dig. §§ 37-39; Dec. Dig. § 15.*]

Appeal from the United States Court of Appeals in the Indian Territory.

Albert J. Lee and Webster Ballinger, for appellants.

James E. Humphrey and Charles W. Russell, Asst. Atty. Gen., for appellees.

Before SANBORN, HOOK, and ADAMS, Circuit Judges.

HOOK, Circuit Judge. Bettie Ligon, on behalf of herself and several hundred others alleged to be similarly situated and to be of Choctaw and Chickasaw Indian descent and members of the Choctaw and Chickasaw tribes, brought suit in the United States Court for the Southern District of the Indian Territory against James R. Garfield, as Secretary of the Interior, and Douglas H. Johnston and Green McCurtain, and all other persons whose names appear with theirs on the citizenship rolls of the Choctaw and Chickasaw Nations, as approved by the Secretary on or before March 4, 1907, to enjoin the distribution of the funds and the sale and disposition of the unallotted lands of those

*For other cases see same topic & § NUMBER in Dec. & Am. Digs. 1907 to date, & Rep'r Indexes

tribes until complainants' asserted rights as citizens of the tribes by blood are recognized and they are placed upon the rolls so they may receive allotments as such and participate with other citizens in the funds. The trial court sustained a demurrer to the bill and dismissed the suit; its action was affirmed by the Court of Appeals in the Indian Territory, and complainants appealed to this court.

The lands in question are a part of those granted by the United States to the Choctaws March 23, 1842, in compliance with the treaty entered into September 27, 1830 (7 Stat. 333), as the result of negotiations for the removal of the Indians from the states of Mississippi and Alabama to the country west of the Mississippi river, and the funds in question are proceeds of like lands. The Chickasaws obtained an interest in common with the Choctaws by a treaty between them made January 17, 1837, and approved by the President and Senate of the United States (11 Stat. 573). The treaty of 1830 with the Choctaws provided that the United States under a grant specially to be made by the President "shall cause to be conveyed to the Choctaw Nation a tract of country west of the Mississippi river in fee simple to them and their descendants, to inure to them while they shall exist as a nation and live on it," and the patent afterwards issued recited this provision of the treaty, and specified that the lands described were granted to the Choctaw Nation to be held "in fee simple to them and their descendants to inure to them while they shall exist as a nation and live on it liable to no transfer or alienation except to the United States or with their consent." When these treaties and the grant were made and the Choctaws and Chickasaws secured their titles they were slave-holding peoples, and, as was customary where that institution obtained, their slaves were regarded as chattels incapable of owning property. Following the Civil War and the abolition of slavery Congress sought to do such measure of justice to the former slaves as lay within its power. Various treaties were made by the Government with the Indian tribes to that end, among which was that of April 28, 1866, with the Choctaws and Chickasaws (14 Stat. 769), which contained a provision that all persons of African descent resident in the nations and their descendants, theretofore held in slavery, should be entitled, among other things, to 40 acres, each, of the lands of the nations on the same terms as the Choctaws and Chickasaws.

The experience of many years in their new domain west of the Mississippi river demonstrated the incapacity of the Indians for just and equitable government, and gross abuses of power marked the administration of their internal affairs. Congress finally determined to put an end to national or tribal titles, and to cause at least part of their lands to be allotted and divided in severalty among the Indians entitled thereto. A commission, generally called the "Dawes Commission," was created by Act March 3, 1893, c. 209, 27 Stat. 645, and by a series of subsequent acts and by agreements with the tribes it was intrusted with the task under the direction of the Secretary of the Interior. The commission was directed to make correct rolls of Choctaw and Chickasaw citizens by blood and also correct rolls of the freedmen of those tribes and descendants of freedmen, who were entitled to 40 acres of land under the treaty of 1866. The rolls so made were to be final

when approved by the Secretary of the Interior, and those whose names appeared thereon could alone participate in the distribution of tribal property. The act of April 26, 1906, c. 1875, 34 Stat. 137 (U. S. Comp. St. Supp. 1907, p. 867), providing for the final disposition of the affairs of the tribes, required the rolls to be fully completed by March 4, 1907, and deprived the Secretary of the Interior of jurisdiction to approve the enrollment of any person after that date. The rolls were completed and the time for change expired. The complainants say they were erroneously put upon the freedmen's rolls, and, though they are of African descent, they claim they should be enrolled as citizens by blood and consequently have a larger participation in the property to be distributed because they are also of Indian blood, being descendants of Choctaws living at the date of the treaty of 1830 or of Chickasaws living at the date of the treaty of 1837. To be more precise: Their contention is that by the treaties mentioned and the subsequent grant of 1842 from the United States an indefeasible, undivided interest became vested in each member of the Choctaw and Chickasaw tribes and their descendants without regard to the quantum of Indian blood or the admixture of African blood, and that the Indian nations merely took title in trust for the individual members and their descendants as beneficiaries; that their titles and rights to lands and moneys being vested in them are therefore beyond the power of Congress or of any administrative department of the government to impair, divest, or destroy. Complainants contend that the language of the treaty of 1830 and the grant of 1842 to the Choctaw Nation "in fee simple to them and their descendants to inure to them while they shall exist as a nation and live" on the lands granted is exceptional, and is distinguishable from that employed in other treaties and grants to other Indian tribes, often held by the courts as conveying title to the tribes and not to the individual members thereof. We do not think the contentions can be sustained. We find nothing in the history of the Choctaws, their relations to the government and the negotiations leading to their removal west of the Mississippi river, that would afford a reason for such a radical departure from the course pursued with other tribes under like circumstances, nor do we think the words of the treaty and the grant in question are so dissimilar from those employed in other cases as to indicate a different purpose. That the lands involved were public lands belonging to the Choctaw and Chickasaw Nations and not to the individual members has been assumed without contradiction from the inception of their titles through a long sequence of acts of Congress and treaties and agreements with the tribes. True, as contended, the title so held has frequently been referred to as being held in trust for the members of the tribes, but it is so only in the broad, comprehensive sense in which the public property of any representative government is in trust for the welfare of its people. Until specific, private, individual rights attach pursuant to law, the enforcement of such trusts must be at the bar of public conscience. They are not justiciable in the courts. The disposition of the tribal property of the Indian tribes falls within the legislative domain, the power of Congress is supreme, and its action is conclusive upon the courts. *Cherokee Nation v. Hitchcock*, 187 U. S. 295, 23 Sup. Ct. 115, 47 L.

Ed. 183; *Lone Wolf v. Hitchcock*, 187 U. S. 553, 23 Sup. Ct. 216, 47 L. Ed. 299.

In *Stephens v. Cherokee Nation*, 174 U. S. 488, 19 Sup. Ct. 722, 43 L. Ed. 1041, it was said that the lands and moneys of the Indian nations then before the court were public lands and moneys, and the acts of Congress relating to the determination of citizenship could not be successfully assailed on the ground of the impairment or destruction of vested rights; and the court was then speaking of the title of the Choctaws and Chickasaws as well as of that of the Cherokees. Whether complainants should be enrolled as citizens of the Indian Nations is a political or administrative question, and none the less so because upon its determination depends the measure of their participation in the tribal property. *Wallace v. Adams*, 74 C. C. A. 540, 143 Fed. 716; *Id.*, 204 U. S. 415, 27 Sup. Ct. 363, 51 L. Ed. 547. For many years the power to determine who were and who were not citizens of these tribes was left exclusively to the tribal authorities; names were added to and stricken from the rolls at will; and when Congress, to end the arbitrary practice, intrusted the power to administrative officers of the government who had no private interests to subserve it did not change that which was of a purely political character into a subject-matter for the intervention of the courts. *West v. Hitchcock*, 205 U. S. 80, 27 Sup. Ct. 423, 51 L. Ed. 718.

These conclusions are fatal to the case of complainants, and the result is not affected by the charges of fraud made in the bill against subordinate officials.

Affirmed.

In re BROWN.

BROWN v. MAJOR et al.

(Circuit Court of Appeals, Ninth Circuit. October 5, 1908.)

No. 1,601.

BANKRUPTCY (§ 76*)—INVOLUNTARY PROCEEDINGS—PETITIONING CREDITORS.

Const. Cal. art. 12, § 3, provides that "the directors or trustees of corporations and joint-stock associations shall be jointly and severally liable to the creditors for all moneys embezzled or misappropriated by the officers of such corporation or joint-stock association during the term of office of such director or trustee. The Supreme Court of the state, whose decision in that regard is binding on the federal courts, has held that such provision is self-executing, and that the liability of a director to creditors thereunder is contractual and may be enforced by any creditor against any director by an action at law. *Held*, that the liability of a director of a savings bank corporation, whose funds have been embezzled or misappropriated by its officers, to depositors in such bank, is a fixed liability absolutely owing within the meaning of Bankr. Act July 1, 1898, c. 541, § 63a (1), 30 Stat. 562 (U. S. Comp. St. 1901, p. 3447), and that such depositors are creditors who may join in a petition in involuntary bankruptcy against the director.

[Ed. Note.—For other cases, see Bankruptcy, Dec. Dig. § 76.*]

*For other cases see same topic & § NUMBER in Dec. & Am. Digs. 1907 to date, & Rep'r Indexes 164 F.—43

Petition for Revision of Proceedings of the District Court of the United States for the Northern District of California, in Bankruptcy.

Hiram W. Johnson, for petitioner.

Daniel O'Connell, for respondents.

Before GILBERT, ROSS, and MORROW, Circuit Judges.

ROSS; Circuit Judge. This is a petition for the revision, under section 24b of the bankruptcy act of July 1, 1898, c. 541, 30 Stat. 553 (U. S. Comp. St. 1901, p. 3432), of an order of the United States District Court for the Northern District of California.

The petition to this court shows that on the 28th day of January, 1908, Frieda R. Major, Maude A. Ralston, and Kate A. O'Connell, as administratrix of the estate of George P. O'Connell, presented a petition to the judge of the court below praying that the present petitioner be adjudged bankrupt. Brown filed a demurrer to that petition, which demurrer the court below overruled, and it is that ruling that is here sought to be revised. The real grounds of the demurrer were that the petition for the adjudication in bankruptcy did not show that the petitioners thereto were holders of provable claims against Brown or his estate, that the amount of the alleged claims of the petitioners against the alleged bankrupt was not sufficient to entitle them to the relief sought, and that the averments of the petition filed by the alleged creditors were indefinite and uncertain in certain enumerated particulars.

The petition to which the demurrer was interposed alleged, among other things, that the California Safe Deposit & Trust Company was then, and for more than five years then last past had been, a corporation organized and existing under the laws of the state of California, and until October 30, 1907, conducted a general banking business under the laws of that state, and also carried on the business of a savings and loan corporation, and also of keeping money and other valuable personal property in safe-deposit vaults at agreed rentals, and acted as executor, administrator, guardian, trustee, and receiver, discounted bills of exchange and other evidences of indebtedness, and received moneys on deposit, payable on demand and otherwise; that the whole amount of the capital stock of the company was three millions of dollars, divided into 30,000 shares of the par value of \$100 each, of which stock 22,122 shares were subscribed for and issued, 577 of which were issued to and then held by Brown; that on November 1, 1907, Brown was, and for five years prior thereto had been, a director and vice president and manager of the company, and was not, and had not been during the period mentioned, a wage-earner or engaged chiefly in farming or the tilling of the soil; that on October 30, 1907, the company closed its doors and refused to pay on demand the money deposited therein, and refused to pay any of its debts or obligations, and has continued in such refusal, and has kept its doors closed ever since; that on December 7, 1907, the bank commissioners of the state of California adjudged the company insolvent, and that it was dangerous for it to continue to do business, and on December 9th of the same year the Attorney General of the state commenced an action in the name

of the people of the state against the company and its officers and directors, in the superior court of the state in and for the city and county of San Francisco, to have the company adjudged insolvent and a receiver thereof appointed, and that on January 3, 1908, a default was entered against such officers and directors, including Brown, and that on January 14, 1908, the said superior court adjudged the company insolvent and appointed a receiver of its property; that the petitioners are creditors of Brown having provable claims amounting in the aggregate, in excess of securities held by them, to the sum of \$500, the nature and amount of which are as follows:

"That said California Safe Deposit and Trust Company was insolvent on said December 7th, 1907, and for more than a year prior thereto said J. Dalzell Brown well knew during all that time, and advertised and requested your petitioners and others to deposit their money with said company, and during the months of September and October, 1907, your petitioner Kate A. O'Connell, as such administratrix, deposited the sum of one thousand seven hundred and seventy-four dollars (\$1,774.00) with said company, and in the month of October, 1907, said Frieda R. Major deposited the sum of eleven hundred and twenty-five dollars (\$1,125.00) with said company, and about July or August, or September, 1907, said Maude A. Ralston deposited the sum of one hundred dollars (\$100.00) with said company, said company receiving and keeping each and all of said deposits as a savings bank under the laws of the state of California, agreeing to return said money to said depositors on demand, and the allowance of said deposits by said Brown at said time was a violation of section 562 of the Penal Code of the state of California."

That petitioners thereafter demanded from said company the payment of the amount of their several deposits of money, which the company refused to pay, and that no part thereof has ever been paid to the petitioners or to any person for them; that the petitioners thereafter demanded from the California Safe Deposit & Trust Company payment of the amount of their said several deposits, no part of which payment has ever been made; that during the three years then last past, and during the term of office of the said Brown, moneys were embezzled and misappropriated by the officers of the company as follows:

"(1) In violation of section 571 of the Civil Code of the state of California, more than the sum of five million dollars of the money of the depositors of said bank and corporation was loaned on inadequate security.

"(2) In violation of section 578 of said Civil Code more than the sum of three million dollars of the deposits and funds of said corporation was directly and indirectly borrowed by the directors and officers of said corporation.

"(3) In violation of said section 578 more than five million dollars of the deposits and funds of said corporation were loaned, for which officers and directors of said corporation became and were obligors, indorsers, and sureties.

"(4) In violation of section 561 of the Penal Code, officers of said corporation overdraw their accounts with said bank and wrongfully obtained the money and funds of said bank to the amount of one million dollars.

"(5) In violation of section 560 of the Penal Code, and section 309 of the Civil Code, dividends to more than one million dollars were made and paid from other than the surplus profits arising from the business thereof.

"(6) In violation of said sections of the Penal Code and Civil Code, the capital stock of said corporation to ——— dollars was divided, withdrawn, and paid to certain stockholders of said corporation.

"(7) In violation of said sections of the Codes, debts to the amount of six million dollars beyond the subscribed capital stock were created.

"(8) During the three years said J. Dalzell Brown and other officers and

directors of said corporation knowingly received and possessed themselves of the moneys, stocks, bonds, and other property of said corporation otherwise than in the payment of a just demand, and, with intent to defraud, omitted to make, or caused or directed to be made, a full and true entry thereof in the books and accounts of said corporation.

"(9) During the past three years said corporation and savings bank has purchased, held, and conveyed, and now holds, stock and shares of various worthless and insolvent corporations amounting to more than four million dollars, which section 574 of the Civil Code and other laws of the state of California prohibits said corporation from purchasing, holding, or conveying.

"(10) The moneys received by said bank and corporation, and its officers and directors, were received as a bank for safe keeping, savings, and loan, according to the restrictions provided by law, and during the past three years said savings bank and corporation purchased, invested, and loaned its capital and the money of its depositors in mining shares or stocks to the amount (amount) of more than one million dollars."

The petition of the creditors further alleges that Brown is insolvent, and that within four months next preceding the filing of the petition, while so insolvent, he committed acts of bankruptcy as follows:

"(1) On or about December 13, 1907, an action was commenced in said superior court against J. Dalzell Brown by A. B. Southard and J. A. Bloch for the sum of \$3,693.70, and said Brown, with intent to prefer such creditors, allowed a judgment by default to be entered against him in said action on or about December 23, 1907, and said judgment constitutes a lien on the real estate of said Brown, and is still in full force and effect.

"(2) On or about the —— day of December, 1907, said Brown, with intent and purpose of hindering, delaying, and defrauding his creditors, and especially your petitioners, made and caused to be made conveyances and transfers of the property hereinafter described, and other property, to his wife, Harriet D. Brown, of said city and county of San Francisco, without any valuable consideration, and with intent to prefer said Harriet D. Brown to all his other creditors, and especially these petitioners, and said Harriet D. Brown joined in said intent and purpose: (1) That parcel of land on the southerly side of Washington street and east of Buchanan street, in said city and county of San Francisco, with the improvements thereon, numbered 2231 Washington street, and a part of block 238 of the Western addition of said city and county of San Francisco, and more particularly described in said conveyances, duly recorded in the office of the county recorder of said city and county of San Francisco on the —— day of December, 1907. (2) That large tract of land situated on the east side of Clear Lake, in Lake county, state of California, and known as 'Carson Rancho.' (3) Shares of stock in various corporations, and automobiles and other personal property, and particulars of which these petitioners are not at present prepared to state with certainty."

The provision of section 59b of the bankrupt act (Act July 1, 1898, c. 541, 30 Stat. 561 [U. S. Comp. St. 1901, p. 3445]) is that:

"Three or more creditors who have provable claims against any person which amount in the aggregate, in excess of the value of securities held by them, if any, to five hundred dollars or over; or if all of the creditors of such person are less than twelve in number, then one of such creditors whose claim equals such amount may file a petition to have him adjudged a bankrupt."

As it appears from the creditors' petition that Brown is the owner of only $2\frac{1}{8}$ per cent. of the capital stock of the California Safe Deposit & Trust Company, the amount of his liability to them as such stockholder is less than the statutory amount of \$500, and, therefore, the petition, in so far as it is based upon the alleged bankrupt's liability as a stockholder, is insufficient. It must, therefore, rest upon his liability as an officer and director of the bank. Amounting in the aggre-

gate, as they do, to \$2,899, the claims form a sufficient basis for the petition if they are provable against the alleged bankrupt. Provable claims, under the provisions of section 63 of the bankrupt act, include debts of the bankrupt which are—

“(1) a fixed liability as evidenced by a judgment or an instrument in writing, absolutely owing at the time of the filing of the petition against him, whether then payable or not, with any interest thereon which would have been recoverable at that date or with a rebate of interest upon such as were not then payable and did not bear interest; * * * (4) founded upon an open account or upon a contract express or implied. * * *”

By section 3 of article 12 of the Constitution of California it is declared:

“The directors or trustees of corporations and joint stock associations shall be jointly and severally liable to the creditors for all moneys embezzled or misappropriated by the officers of such corporation or joint stock association during the term of office of such director or trustee.”

And section 309 of the Civil Code of California provides:

“The directors of corporations must not make dividends except from the surplus profits arising from the business thereof; nor must they create any debts beyond their subscribed capital stock; nor must they divide, withdraw, or pay to the stockholders, or any of them, any part of the capital stock except as hereinafter provided, nor reduce or increase the capital stock except as herein specially provided. For a violation of the provision of this section, the directors under whose administration the same may have happened (except those who may have caused their dissent therefrom to be entered at large on the minutes of the directors at the time, or were not present when the same did happen) are, in their individual or private capacity, jointly and severally liable to the corporation and to the creditors thereof, to the full amount of the capital stock so divided, withdrawn, paid out, or reduced, or debt contracted; and no statute of limitations is a bar to any suit against such directors for any sums for which they are liable by this section.”

Statutes making officers and directors of a corporation responsible to its creditors for losses growing out of the negligent, wrongful, or fraudulent conduct of such officers or directors are regarded by most courts as of a penal nature, and as not arising out of contract. *Patterson v. Thompson* (C. C.) 86 Fed. 85, and cases there cited; 21 Am. & Eng. Ency. of Law, p. 882. But we have here a decision of the Supreme Court of California construing the above-quoted provision of the Constitution of that state, in which that court distinctly held that the liability imposed by section 3 of article 12 of the Constitution of California is one of suretyship, and therefore of contract, to enforce which liability any creditor may sue such officer or director at law; that the right of the individual creditor does not depend upon others, and that “if the necessary parties are not brought in, and that fact is made to appear, the court should order them to be brought in.” *Winchester v. Howard*, 136 Cal. 432, 444, 446, 447, 64 Pac. 692, 69 Pac. 77, 89 Am. St. Rep. 153. That case was thus stated by the court:

“This appeal is from a judgment entered upon a demurrer to the complaint. The plaintiff, who was himself a depositor in the Savings Bank of San Diego County, as assignee of himself and of many other depositors, brings this action against the directors of the savings bank for the sum of \$127,570.29, which is alleged to be the amount of deposits made by such depositors in the bank between the first day of July, 1886, and the twenty-third day of June, 1893, with interest added. The action purports to have been brought on be-

half of himself and any other creditors who may choose to join him. The purpose of the action is to enforce the liability of the defendants for money alleged to have been misappropriated by the defendants while they were directors of such savings bank.

"It is alleged that the savings bank suspended payment on the twenty-third day of June, 1893, and in 1895 was declared insolvent and placed in the hands of its officers, under the banking act, for liquidation.

"Twenty-seven different alleged misappropriations are set out in the complaint. All consisted in taking money out of the bank and applying it to unauthorized purposes, in the interest of said directors, or of some of them. It is charged that at no time when the alleged misappropriations were made did the bank have fifty per cent. of its loans secured by mortgages on real estate, or upon real estate the market value of which exceeded the amount of the loan by sixty per cent. The nominal capital of the savings bank was one hundred thousand dollars, only twenty thousand dollars of which was ever paid in. Most of the misappropriations are alleged to have been made for the benefit of the Consolidated National Bank, a corporation in which Mabury and Howard were stockholders, and of which they were directors. All misappropriations are charged to have been made for the benefit of Howard and Mabury. It is charged that such misappropriations were made by or under the direction of Howard, who acted for Mabury as well as for himself.

"The complaint was demurred to on various grounds, but, by stipulation, only certain grounds of demurrer, out of more than one hundred contained in the demurrer, are in the transcript. The language of the stipulation will throw some light upon the questions submitted on the appeal. It reads as follows:

"It is hereby stipulated that, whereas the plaintiff herein has appealed from the judgment herein sustaining the demurrer of defendant Hiram Mabury, that on such appeal the appellant shall print only the 3d, 87th, 88th, 93d, 94th, 95th, 96th, and 99th grounds of demurrer; and that if the judgment should be sustained that should end this case; but if it should be reversed, then the demurrer upon the other grounds, not printed, should stand for argument in the court below.

"This course is taken because it is claimed by the plaintiff that he can avoid the other grounds of demurrer by amendment of the complaint, even if well taken to the complaint as it now stands. Whereas, it is conceded that if the demurrer is sustained on the grounds above stated it would necessarily end this case without further litigation.

"It is stipulated that the plaintiff must recover on the provisions of the latter part of section 3, article 12, of the Constitution of California, or that he cannot recover at all.

"It is stipulated that the above grounds of demurrer fully raise the following propositions contended for by defendant, viz.:

"1st. That said constitutional provision is not effectual without legislation.

"2d. That misappropriation, as meant by the Constitution, is not shown by the allegations of the complaint.

"3d. That there is a misjoinder of causes of action. And that this point can be considered, notwithstanding the causes of action are not separately stated.

"4th. That the Constitution does not purport to give, and hence does not give, any right of action under such provision to an assignee.

"5th. That in no case is such an action assignable.

"6th. That the plaintiff was not nor was any of his assignors alleged to be creditors when any of the alleged misappropriations took place.

"7th. Defect of parties.

Withington & Carter,

"C. H. Rippley,

"S. F. Leib,

"Attorneys for Plaintiff.

"Attorney for Defendant Mabury.

"Filed June 23d, 1899."

"The constitutional provision referred to reads as follows: 'The directors or trustees of corporations and joint-stock associations shall be jointly and severally liable to the creditors and stockholders for all moneys embezzled

or misappropriated by the officers of such corporation or joint-stock association during the term of office of such director or trustee.'

"The parties seem agreed that the following questions are involved in this appeal:

"(1) Is the constitutional provision self-executing?

"(2) Do the alleged misappropriations come within it?

"(3) Can the action be maintained by an assignee?

"(4) Can the action be maintained by or for a creditor who becomes such after the alleged misappropriation?

"(5) Have all the necessary parties been brought in as plaintiffs or defendants in this case, and is this an action for an accounting?

"(6) Can such an action be maintained by a mere contract creditor? Must the claim against the corporation be first reduced to judgment?

"It is further contended on behalf of the defendants that the constitutional provision is void as being in conflict with the fourteenth amendment to the federal Constitution, and because opposed to natural justice; and, further, that the action is to recover damages for negligence or fraud, and is barred by the statute of limitations."

The court held the provision of the Constitution in question to be self-executing, and placed upon it the construction already indicated. That construction of the Constitution of the state by the highest court in existence under it is binding upon the federal courts. *Flash v. Conn.*, 109 U. S. 371, 3 Sup. Ct. 263, 27 L. Ed. 966.

It results that the District Court was right in overruling the demurrer.

The petition for revision is dismissed at the petitioner's cost.

In re BARNETT.

BARNETT v. MAJOR et al.

(Circuit Court of Appeals, Ninth Circuit. October 5, 1908.)

No. 1,604.

Petition for Revision of Proceedings of the District Court of the United States for the Northern District of California, in Bankruptcy.

Charles R. Gray and Gray & Cooper, for petitioner.

Daniel O'Connell, for respondents.

Before GILBERT, ROSS, and MORROW, Circuit Judges.

PER CURIAM. On the authority of the case of *J. Dalzell Brown, Petitioner, v. Frieda R. Major and Others, Respondents*, 164 Fed. 673, the petition for revision is dismissed at the petitioner's cost.

WALKER v. WOODSIDE et al.†

In re WALKER.

(Circuit Court of Appeals, Ninth Circuit. October 5, 1908.)

No. 1,602.

1. BANKRUPTCY (§ 82*)—INVOLUNTARY PROCEEDINGS—VERIFICATION OF PETITION.

A petition in involuntary bankruptcy in which a corporation and a partnership join may be verified for the corporation by its president and for the partnership by one of its members.

[Ed. Note.—For other cases, see Bankruptcy, Cent. Dig. § 123; Dec. Dig. § 82.*]

2. BANKRUPTCY (§ 76*)—PETITIONING CREDITORS—PROVABLE CLAIMS—STOCKHOLDERS' LIABILITY.

By Const. Cal. art. 12, § 3, and Civ. Code, § 322, a stockholder in a corporation is made liable for his proportion of all of the debts of the corporation contracted while he is such stockholder, which liability in the case of banking corporations arises at the time of the respective deposits, and, by Civ. Code Proc. § 359, must be enforced by an action commenced within three years. *Held*, that depositors in an insolvent savings bank were creditors of a stockholder therein to the extent of his proportion of their claims where the deposits were made within three years, and that three or more depositors whose claims against him so computed amount to \$500 may maintain a petition in involuntary bankruptcy against him.

[Ed. Note.—For other cases, see Bankruptcy, Dec. Dig. § 76.*]

3. BANKRUPTCY (§ 84*)—AMENDMENT OF PETITION—ALLEGING ADDITIONAL ACTS OF BANKRUPTCY.

Acts of bankruptcy not alleged in an involuntary petition, nor in an intervening petition by other creditors, cannot be set up by an amendment to either where they were committed more than four months before such amendment is made.

[Ed. Note.—For other cases, see Bankruptcy, Cent. Dig. §§ 126-129; Dec. Dig. § 84.*]

Petition for Revision of Proceedings of the District Court of the United States for the Northern District of California.

G. H. Whipple and Chickering & Gregory, for petitioner.

Daniel O'Connell, Bert Schlesinger, Henry G. W. Dinkelspiel, and S. C. Wright, for respondents.

Before GILBERT, ROSS, and MORROW, Circuit Judges.

ROSS, Circuit Judge. This also is a petition for the revision, under section 24b of the bankrupt act of 1898 (Act July 1, 1898, c. 541, 30 Stat. 553 [U. S. Comp. St. 1901, p. 3432]), of certain orders of the District Court for the Northern District of California, submitted with the cases of *Brown v. Major*, 164 Fed. 673, and *Bartnett v. Major*, 164 Fed. 679, just disposed of, and growing out of similar transactions.

In this case of *Walker*, the petitioner here seeks the review of the action of the District Court in denying his motion to dismiss the amended original petition filed by Alexander J. Woodside, E. A. Groe-

*For other cases see same topic & § NUMBER in Dec. & Am. Digs. 1907 to date, & Rep'r Indexes

†Rehearing denied November 6, 1908.

zinger, and E. O. Schraubstadter, copartners doing business under the firm name and style of A. Finke's Widow, Crowley Launch & Tugboat Company, a corporation, Thomas Crowley, C. D. Freiderichs, and H. H. Clark, for the adjudging of Walker an involuntary bankrupt, and also of an order of the District Court overruling a demurrer filed by him to that petition, and also the revision of an order overruling a motion made by the alleged bankrupt for the dismissal of the petition and amended petition in intervention filed in the said involuntary bankruptcy proceedings by Frieda R. Major, Kate A. O'Connell, as administratrix of the estate of George P. O'Connell, and of an order made by the District Court overruling a demurrer filed by the alleged bankrupt to the said amended petition in intervention.

The ground of the motion made for the dismissal of the amended original petition is that it was not properly verified. Assuming that the motion made was a proper method of raising the objection, we think it is without merit. The record shows that the amended petition was signed by all of the then petitioning creditors of the alleged bankrupt, the signature of the Crowley Launch & Tugboat Company being made by its president, with the seal of the corporation attached, and that it was verified by Schraubstadter, one of the members of the firm of A. Finke's Widow, by the president of the Crowley Launch & Tugboat Company on its behalf, and by Thomas Crowley individually, one of the alleged creditors; so that it appears that the requisite number of creditors joined in the verification of the amended original petition. It cannot be doubted that, since a corporation must act through some agent, a verification on its behalf may be legally made by its president. Nor can it be doubted that a member of a partnership may properly verify a claim made on behalf of the firm of which he is a member.

The amended original petition alleges, among other things, that at all the times therein mentioned the California Safe Deposit & Trust Company was, and still is, a corporation duly organized and existing under the laws of the state of California, having its principal place of business in the city and county of San Francisco; that within four months of the filing of the petition that company conducted a general banking business, under the laws of the state of California, in connection with its other business therein specified; that the whole amount of its capital stock was and is \$3,000,000, divided into 30,000 shares of the par value of \$100 each, of which 26,122 shares were issued; that at all the times mentioned in the petition Walker was, and still is, the holder of 800 of those shares; that the petitioners are creditors of the said Walker, having provable claims against him amounting, in the aggregate, in excess of securities held by them, to the sum of \$1,052.35, the nature and amount of which claims are specifically stated in the petition, and consist of various deposits of money made in the said California Safe Deposit & Trust Company by the respective petitioning creditors at various times during the two years immediately preceding the filing of the petition, such deposits by Woodside aggregating \$8,300; by Groezinger and Schraubstadter, as copartners under the firm name of A. Finke's Widow, \$5,222.25; by the Crowley Launch

& Tugboat Company, \$5,080; by Thomas Crowley, \$1,690; by Friedrichs, \$3,900; and by Clark, \$8,000—all of which moneys the amended original petition alleges have ever since been due and owing to the respective depositors by said bank, and for his proportion thereof, aggregating \$1,052.35, the alleged bankrupt has at all times been, and still is, liable to said respective depositors. The amended original petition further alleges that the said California Safe Deposit & Trust Company is insolvent and unable to pay its debts and liabilities, and that, within four months immediately preceding the date of and the filing of the said petition—

“the said respondent David F. Walker committed an act of bankruptcy, in that he did heretofore, to wit, on the 26th day of November, 1907, in the city and county of San Francisco, state and district aforesaid, transfer and convey to his wife, Althea Walker, a large portion of his property hereinafter described, with the intent then and there to defraud, hinder, and delay his creditors.

“That the said property transferred and conveyed as aforesaid is situate, lying, and being in the city and county of San Francisco, state and district aforesaid, and is particularly described as follows, to wit:

“Parcel No. 1. Commencing at the southwest corner of Laguna Street and Pacific Avenue, running thence southerly along the westerly line of Laguna Street ninety-four (94) feet eight and one-fourth ($8\frac{1}{4}$) inches; thence at right angles westerly ninety-six (96) feet; thence at right angles southerly thirty-three (33) feet; thence at right angles westerly forty-one (41) feet, six inches (6); thence at right angles northerly one hundred and twenty-seven (127) feet, eight and one-fourth ($8\frac{1}{4}$) inches to the southerly line of Pacific Avenue; thence at right angles easterly along the last named line one hundred and thirty-seven (137) feet, six inches, to the point of commencement. Being a portion of Western Addition Block Number Two Hundred and Forty (240) of the City and County of San Francisco.

“Parcel No. 2. Commencing at a point on the southerly line of Pacific Avenue distant thereon one hundred and sixty-seven (167) feet, six (6) inches, westerly from the westerly line of Laguna Street; running thence westerly along said southerly line of Pacific Avenue sixty (60) feet; thence at right angles southerly one hundred and twenty-seven (127) feet, eight and one-fourth ($8\frac{1}{4}$) inches; thence at right angles easterly sixty (60) feet; thence at right angles northerly one hundred and twenty-seven (127) feet eight and one-fourth ($8\frac{1}{4}$) inches to the southerly line of Pacific Avenue and point of commencement. Being a portion of Western Addition Block Number Two Hundred and Forty (240) of the City and County of San Francisco.

“Parcel No. 3. Commencing at a point on the northerly line of California Street, distant thereon fifty-four (54) feet, three (3) inches easterly from the easterly line of Steiner Street; running thence easterly along said line of California Street one hundred and fifty-one (151) feet; thence at right angles northerly one hundred and thirty-two (132) feet, eight and one-fourth ($8\frac{1}{4}$) inches; thence at right angles westerly ninety-nine (99) feet; thence at right angles southerly twenty-six (26) feet six (6) inches; thence at right angles westerly fifty-two (52) feet; thence at right angles southerly one hundred and six (106) feet, two and one-fourth ($2\frac{1}{4}$) inches to the northerly line of California Street and the point of commencement. Being a portion of Western Addition Block Number Three Hundred and Fifty-three (353) of the City and County of San Francisco.

“Parcel No. 4. Commencing at a point on the northerly line of Pacific Avenue, distant thereon one hundred and thirty-nine (139) feet, nine inches easterly from the easterly line of Webster Street; thence running easterly along said northerly line of Pacific Avenue thirty-five (35) feet; thence at right angles northerly one hundred and thirty-two (132) feet, seven and one-eighth ($7\frac{1}{8}$) inches; thence at right angles westerly thirty-five (35) feet; thence at right angles southerly one hundred and thirty-two (132) feet, seven and one-eighth ($7\frac{1}{8}$) inches to the point of commencement. Being a portion of Western

Addition Block Number Two Hundred and Sixty-six (266) of the City and County of San Francisco.

"XII.

"That the deed made, executed, and delivered by said respondent transferring and conveying the above-described real property to Althea Walker, his wife, as aforesaid, was, and is, without consideration, and was made and delivered with the intent then and there to defraud, hinder, and delay the creditors of said respondent.

"That said deed was recorded in the office of the recorder of the city and county of San Francisco, state of California, on the 27th day of November, 1907, at seven minutes past 3 o'clock p. m. of said day, in Liber 116 of Deeds, at page 296."

The only ground of the demurrer to the amended original petition insisted upon here is that that petition is uncertain in that "it is alleged that the various sums claimed to be due the petitioners herein from the California Safe Deposit & Trust Company is the aggregate sum of various deposits of money by said petitioners at various times within two years last past; and in other allegations it is stated that this respondent became indebted to the petitioners herein on the 26th day of November, 1907, by reason of the fact that said respondent was a stockholder in the California Safe Deposit & Trust Company."

The Constitution, as well as a statute of California, makes a stockholder in a corporation organized under its laws liable for his proportion of all of the debts of the corporation during the time he was such stockholder (section 3, art. 12, Const.; section 322, Civ. Code), which liability, in the case of banking corporations, arises at the time of the respective deposits. *Wells v. Black*, 117 Cal. 157, 163, 48 Pac. 1090, 37 L. R. A. 619, 59 Am. St. Rep. 162. By section 359 of the Code of Civil Procedure of the state, it is provided that an action against a stockholder to recover his proportion of the debts of the corporation must be commenced within three years after the liability arises. The amended petition under consideration alleges that within two years then last past the six petitioning creditors had, respectively, deposited with the banking corporation of which the alleged bankrupt was a stockholder certain specific sums of money, for which the corporation was on November 26, 1907, and still is, indebted, and for his proportion of which, aggregating, according to the petition, \$1,052.35, Walker then was, and still is, indebted. That such a claim arises out of contract was decided by the Supreme Court of the state in *Kennedy v. California Savings Bank*, 97 Cal. 93, 31 Pac. 846, 33 Am. St. Rep. 163, and *Dennis v. Superior Court*, 91 Cal. 548, 27 Pac. 1031. They are, therefore, provable claims under the express terms of section 63 of the bankrupt act. The District Court was clearly right in overruling the demurrer to the amended original petition.

There remains to consider the petition and amended petition in intervention. The original petition in the involuntary proceedings was filed December 30, 1907, and alleged, in substance, the same acts of bankruptcy by Walker that are more fully stated in the amended original petition; that is to say, the conveyance by the alleged bankrupt to his wife of four parcels of land, without consideration, and for the purpose of hindering, delaying, and defrauding his creditors. The original petition in intervention was filed January 28, 1908. It was filed pursuant to that provision of the bankrupt act which reads as follows:

"Creditors other than original petitioners may at any time enter their appearance and join in the petition, or file an answer and be heard in opposition to the prayer of the petition." Section 59f, Act of 1898.

In it the interveners, after alleging "that on the ——— day of December, 1907, the said petition of creditors praying that said David F. Walker be adjudged an involuntary bankrupt was duly filed in this court, and orders to show cause and subpoenas were duly issued out of this court, and with copies of said petition were duly served on said David F. Walker, and the time for appearing and pleading to said petition expires on January 30, 1908; that your petitioners adopt and join in the allegations in said petition against the California Safe Deposit & Trust Company, and the defendant and respondent David F. Walker, and join in the other allegations and prayers of said petition"—proceeded to allege, in effect, that the intervening petitioner Frieda R. Major was a depositor in the California Safe Deposit & Trust Company to the extent of \$1,125, and the intervening petitioner Kate A. O'Connell, as administratrix of the estate of George P. O'Connell, deceased, in the sum of \$1,774, all of which deposits remain due and unpaid, and that the alleged bankrupt was liable to them therefor by reason of certain alleged wrongful and negligent acts on his part as an officer and director of the corporation. The original petition in intervention also alleged other and different acts of bankruptcy on the part of the alleged bankrupt than those stated in the original and in the amended original petition, in these words:

"These petitioners, on information and belief, further allege that said David F. Walker, knowing all of the facts herein alleged, has secretly conveyed personal property, consisting of shares of stocks, interests in partnerships and firms, automobiles, to third persons for the use and benefit of said Walker, and with intent to defraud, hinder, and delay his creditors, especially these petitioners, and the aggregate of his property at a fair valuation will not be sufficient in amount to pay his debts."

Passing the question of indefiniteness in respect to time, place, persons, and circumstances, it will be observed from the foregoing quotation that there is no allegation that the alleged conveyances of personal property by Walker were made within four months of the filing of the petition to intervene, nor even within four months of the filing of the original petition. But the petition in intervention was amended March 5, 1908, which amended petition in intervention the alleged bankrupt moved the court to strike from its files, and subsequently—the motion being denied—interposed a demurrer thereto, which the court overruled.

Like the original, the amended petition in intervention expressly adopted and joined in the allegations and prayer of the original petition filed December 30, 1907. It supplied an omission from the latter by alleging, what the original did not allege, that "said David F. Walker is not a wage-earner, or engaged chiefly in farming or tillage of the soil." The amended petition in intervention also further alleged the deposits already mentioned, by the interveners Frieda R. Major, and Kate A. O'Connell as administratrix of the estate of George P. O'Connell, deceased, the continued existence of that indebtedness, the insolvency of the bank and of Walker, and the latter's liability to said interveners

for the amount of such deposits by reason of his ownership of 800 of the 26,122 shares of the issued stock of the bank, and also by reason of his alleged negligent and wrongful acts as an officer and director of the corporation. The amended petition in intervention further alleged: "That within four months next preceding the date of the filing of said original petition the said David F. Walker, while so insolvent, committed" other acts of bankruptcy than those specified either in the original petition, or in the original petition in intervention, which additional acts the amended petition in intervention set out.

While we entirely agree with the Circuit Court of Appeals for the Third Circuit that a liberal policy in regard to the allowance of amendments in cases of bankruptcy, as in other cases, "is to be encouraged, where the amendments proposed do not prevent a failure of justice through technicalities, and where their allowance does not affect injuriously any just right of the opposite party" (Hark v. C. M. Allen Company, 146 Fed. 665, 668, 77 C. C. A. 91, 94), the general rule, as said by the Circuit Court of Appeals for the Second Circuit, in *Re Haff*, 136 Fed. 78, 80, 68 C. C. A. 646, "seems to be that an original petition cannot be amended by setting out therein acts of bankruptcy not referred to in the original petition, and occurring more than four months before the application for the order allowing the amendment"—citing numerous cases.

While we are, therefore, of the opinion that that portion of the amended petition in intervention setting up the additional acts of bankruptcy is improper, the difficulty is that none of the grounds of the demurrer go to that objection; and, being of the further opinion, for the reasons stated hereinbefore, and in the opinion in the case of *Brown v. Major et al.* (just decided) 164 Fed. 673, that the amended petition in intervention is otherwise sufficient, the petition for revision is dismissed, at the cost of the petitioner.

CORCORAN v. KOSTROMETINOFF.

(Circuit Court of Appeals, Ninth Circuit. October 12, 1908.)

No. 1,560.

1. APPEAL AND ERROR (§ 1074*)—DECISION—FORM OF DECREE.

Where, on an appeal from an order of a United States commissioner in Alaska, as ex officio probate judge, approving the final account of a guardian and discharging him, the District Court made findings upon which it should have entered a decree affirming the order of the commissioner, the rights of the parties are not prejudiced because, instead, it entered a decree dismissing the appeal.

[Ed. Note.—For other cases, see Appeal and Error, Dec. Dig. 1074.*]

2. APPEAL AND ERROR (§ 387*)—DISMISSAL OF APPEAL—DELAY IN GIVING BOND.

The failure to give a bond for costs at the time of taking an appeal is not ground for dismissing the appeal, provided the bond is filed within a reasonable time and the appellee is not prejudiced by the delay.

[Ed. Note.—For other cases, see Appeal and Error, Cent. Dig. § 2065; Dec. Dig. § 387.*]

*For other cases see same topic & § NUMBER in Dec. & Am. Digs. 1907 to date, & Rep'r Indexes

3. GUARDIAN AND WARD (§ 56*)—LIABILITY OF GUARDIAN—LOAN OF WARD'S FUNDS.

While a mere error of judgment will not subject a guardian to personal liability for the loss of his ward's funds, he is nevertheless held to the exercise of prudence and sound discretion in investing the same, and if he loans his ward's money without security he assumes the entire risk, no matter what may have been the credit of the borrower.

[Ed. Note.—For other cases, see Guardian and Ward, Cent. Dig. § 257; Dec. Dig. § 56.*]

4. GUARDIAN AND WARD (§ 53*)—INVESTMENT OF FUNDS—ORDER OF COURT.

Under the law of Oregon, in force in Alaska prior to the enactment of the Alaska Code, which empowered a probate court to make an order authorizing the investment of funds by a guardian "after notice to all other persons interested," an order made without such notice affords a guardian no protection.

[Ed. Note.—For other cases, see Guardian and Ward, Dec. Dig. § 53.*]

5. GUARDIAN AND WARD (§ 55*)—TIME DEPOSIT IN BANK.

A guardian is permitted to leave the funds of his ward temporarily on deposit in a reputable bank, pending investment or other disposition of the same; but he is personally liable for a loss of funds deposited with a bank for a fixed period of time on a certificate of deposit without security.

[Ed. Note.—For other cases, see Guardian and Ward, Cent. Dig. § 254; Dec. Dig. § 55.*]

Appeal from the District Court of the United States for Division No. 1 of the District of Alaska.

E. M. Barnes, for appellant.

Malony & Cobb, for appellee.

Before GILBERT, ROSS, and MORROW, Circuit Judges.

GILBERT, Circuit Judge. The appellee, George Kostrometinnoff, as guardian of John P. Corcoran, a minor, filed his final report and petition for discharge as such guardian with the United States commissioner, who was ex officio probate judge for the Sitka commissioners' precinct, Alaska. Exceptions to the account were interposed on behalf of the ward. The exceptions were overruled, the account approved, and an order was made discharging the guardian. An appeal was taken to the District Court for the District of Alaska, Division No. 1, at Juneau. Upon the appeal the District Court filed findings of fact, in which the objections to the account were considered and overruled, and the court found as a conclusion of law that the appeal should be dismissed. In accordance therewith a decree was entered dismissing the appeal and allowing the guardian his costs on the appeal. From that decree the present appeal is taken.

The rights of the parties on the appeal are not affected by the fact that the District Court, upon findings which should have led to a decree affirming the decision of the commissioner's court, entered instead thereof a decree of dismissal.

The appellee moves to dismiss the appeal to this court on the ground that, although the order allowing the appeal was made on January 8, 1908, the appeal bond was not filed until March 2, 1908. The omission to give a bond for costs at the time of taking the appeal is not

*For other cases see same topic & § NUMBER in Dec. & Am. Digs. 1907 to date, & Rep'r Indexes

ground for dismissal, provided that the bond be filed within a reasonable time thereafter, and especially is this true where, as in this case, the appellee is in no respect prejudiced by the delay in filing the bond. *Anson v. Railroad Co.*, 23 How. 1, 16 L. Ed. 517; *Davidson v. Lanier*, 4 Wall. 447, 18 L. Ed. 377; *Seymour v. Freer*, 5 Wall. 822, 18 L. Ed. 564; *Schenck v. Diamond Match Co.*, 73 Fed. 22, 19 C. C. A. 352. The appellee urges as further ground of dismissal the insufficiency of the assignments of error. We find the assignments sufficiently specific to direct our attention to the single question involved on the appeal which we find it necessary to discuss. The motion to dismiss is denied.

On November 7, 1892, in pursuance of an order made by the commissioner's court, the guardian deposited with the Northwest Loan & Trust Company, a banking institution at Portland, Or., \$3,899.76 of the money of his ward for the term of one year, and received therefor a certificate of deposit showing that the amount was deposited to the credit of "George Kostrometinoff, Guardian, etc.," and that interest was to be paid thereon at the rate of 6 per cent. per annum. On July 27, 1893, the bank went into liquidation, and no more than 10 per cent. of the amount so deposited was ever received by the guardian. It is contended on behalf of the ward that the court erred in crediting the guardian's account with the full amount so deposited, and that the guardian, having dissipated \$3,500 of the trust fund, is chargeable therewith. While a mere error of judgment will not subject a guardian to personal liability for the loss of his ward's funds, he is, nevertheless, held to the exercise of prudence and sound discretion in investing the same, and it is uniformly held that, if he loan his ward's money without security, he assumes the entire risk no matter what may have been the credit of the borrower. *Walker v. Walker*, 42 Ga. 135; *Clark v. Garfield*, 8 Allen (Mass.) 427; *Probate Judge v. Mathes*, 60 N. H. 433; *Wycoff v. Hulse*, 32 N. J. Eq. 697; *Lee v. Lee*, 55 Ala. 590.

While the effect of an order of court authorizing the loan or investment is to protect the guardian so far as he proceeds in compliance therewith (21 Cyc. 88, and cases there cited), there can be no doubt that in order to avail himself of such protection he must obtain the order in the manner pointed out by statute, if there be a statute regulating the procedure. At the time when the loan was made in this case, the law of Oregon, which was in force in Alaska, empowered the probate court to make such an order "after notice to all other persons interested." The order in the present case was obtained without such notice, and it cannot, therefore, stand for protection to the guardian. While a guardian is permitted to leave the funds of his ward temporarily on deposit in a reputable bank, pending investment or other disposition of the same, it is the decided weight of authority that he is personally chargeable with the loss of funds deposited with a bank for a fixed period of time upon a certificate of deposit. Such a transaction is a loan without security. *Barney v. Saunders*, 16 How. 535, 14 L. Ed. 1047; *Appeal of Baer (Pa.)* 18 Atl. 1, 4 L. R. A. 609; *State v. Gooch*, 97 N. C. 186, 1 S. E. 653, 2 Am. St. Rep. 284; *Murph v. McCullough*, 40 Tex. Civ. App. 403,

90 S. W. 69; Law's Estate, 144 Pa. 499, 22 Atl. 831, 14 L. R. A. 103. In the case last cited the court quoted with approval from Bispham's Equity, 139:

"A trustee will not be liable for the failure of a bank in which trust funds have been deposited, if he has suffered them to remain there only for a reasonable time; but if he allows them to lie there by way of investment he will be liable to make good the loss."

We can find no justification for the loan which was made by the guardian in the present case. When he assumed the guardianship of the estate, the ward's money was on deposit in the First National Bank at Portland, Or. It is idle to say that it could not have been loaned upon a mortgage on real estate. The testimony that the guardian was unable to make such a loan is not entitled to credence. The very fact that the so-called banking institution which borrowed the money was willing to pay 6 per cent. per annum upon a time deposit is evidence either that there was an active demand for money or that the borrowing bank was engaged in a reckless business. At the time when the loan was made that bank must have been hopelessly insolvent, for eight months later it closed its doors, and on liquidation paid its depositors only 10 cents on the dollar. The guardian had it in his power to safely invest and preserve the money of his ward, and it was his duty to do so. If he had not the time to search for a proper investment, he should have resigned the office.

The decree is reversed, and the cause is remanded to the District Court, with instructions to charge the guardian's account with the sum so lost by the loan to the Northwest Loan & Trust Company, with legal interest thereon from the date of such loan.

In re HAIGHT & FREESE CO.

(Circuit Court of Appeals, First Circuit. March 18, 1908.)

No. 673 (Original).

1. MANDAMUS (§ 190*)—PROCEEDINGS IN FEDERAL COURT—COSTS.

There is no federal statute nor rule of the Supreme Court giving costs to the prevailing party on a mere order to show cause issued on a petition for a writ of mandamus; and the question of costs in such case is therefore governed by the principles which apply to a bill in equity.

[Ed. Note.—For other cases, see Mandamus, Cent. Dig. § 438; Dec. Dig. § 190.*]

2. MANDAMUS (§ 190*)—PROCEEDINGS AGAINST JUDGE.

On a petition for a writ of mandamus against a judge, even where the writ is granted, costs will not be taxed against the judge, although they may be against the adverse parties if they appear on summons or notice and resist the application on the merits; but, where they merely appear and move to dismiss on the ground that the order complained of has been vacated and the writ has become unnecessary, which motion is granted, costs will not be allowed to either party.

[Ed. Note.—For other cases, see Mandamus, Cent. Dig. § 438; Dec. Dig. § 190.*]

*For other cases see same topic & § NUMBER in Dec. & Am. Digs. 1907 to date, & Rep'r Indexes

Petition for Writ of Mandamus to the Circuit Court of the United States for the District of Massachusetts.

On appeal from the ruling of the clerk denying costs.

Franklin Bien, I. R. Clark, and G. F. Ordway, for petitioner.

Before COLT and PUTNAM, Circuit Judges, and ALDRICH, District Judge.

PUTNAM, Circuit Judge. These proceedings were commenced on September 9, 1906, on a petition filed by the Haight & Freese Company for a writ of mandamus to go to the Circuit Court of the United States, and to a judge thereof, directing the judge to allow an appeal which he had refused to allow. His refusal is known to have been based on the theory that there was no final decree; and this was not free from doubt. It is apparent, therefore, that the learned judge in declining to allow the appeal acted judicially in the exercise of judicial discretion.

On filing the petition for the writ of mandamus, a summons to show cause why the petition should not be granted was issued to the adverse parties in the Circuit Court, but none at the outset to the judge thereof. Subsequently, on October 9, 1906, the adverse parties came into this court, and filed a motion to dismiss the petition for mandamus, alleging that the learned judge of the Circuit Court had reconsidered the question of allowing the appeal, and was then willing to allow it; that the Haight & Freese Company declined to accept such allowance, and insisted on pressing its petition; that the Haight & Freese Company might at any time, without the order of this court, obtain all the relief sought by the petition; and that the further maintenance of the petition would be merely a source of vexation and delay. It will be perceived that the adverse parties who thus appeared did not resist the relief asked for by the petition for mandamus, but put their motion to dismiss merely on the ground that mandamus was unnecessary, because the proceeding had become in effect a moot case. Subsequently, on October 30, 1906, this court of its own motion ordered a summons to show cause to issue to the learned judge of the Circuit Court. On November 9th the answer of the learned judge was filed, in which he returned that he had vacated the order disallowing the appeal, and had allowed it. Thereupon the petition for mandamus was dismissed by this court, and all questions of costs were reserved.

On the subsequent application of the Haight & Freese Company, the question of costs was referred to the clerk of this court, who reported adversely thereto, whereupon this application to us to review his report was presented.

If an alternative writ of mandamus had issued, there would have been pending a suit at common law, and one party or the other might have appeared as a prevailing party entitled to costs as contemplated by section 983 of the Revised Statutes (U. S. Comp. St. 1901, p. 706). Phillips' Practice (5th Ed. 1887) 418. There is, however, no statute nor any rule of the Supreme Court which, by its terms, gives costs to a prevailing party on a mere order to show cause issued on a petition for a writ of mandamus, or on any other petition. Therefore the

question of costs on such a petition is governed by the same principles which apply to bills in equity, and to various applications laying the foundation of formal proceedings. High's Extraordinary Remedies (2d Ed. 1884) 403; 2 Spelling's Extraordinary Remedies (2d Ed. 1901) 1466. Consequently in a case like that before us costs were allowed and directions given for taxing the same in *Ex parte Hughes*, 114 U. S. 147, 148, 5 Sup. Ct. 823, 29 L. Ed. 134. There the order to show cause was issued to the judge who was impleaded in the petition, and the application was finally refused. Therefore the costs were taxed against the petitioner, but whether in favor of the judge impleaded or of the party in interest, who undoubtedly had been notified of the proceedings and came in and resisted, the report does not show. At any rate, no judgment for costs went against the judge impleaded because the judgment was the other way.

So far, at least, the practice may be regarded as settled; but the petitioner herein has failed to explain the specific principles on which it claims costs, or to cite text-writers, or any decisions of any court, supporting its position. Certain it is that, even if the case had come properly to an issue, and a judgment directing a writ of mandamus had been entered, costs would not have been taxed under the circumstances against the learned judge of the Circuit Court. It would be contrary to the fundamental rules protecting the freedom of judicial action to tax costs against a judge of any one of the constitutional courts of the United States by reason of any failure to apprehend the law correctly. A formal judgment under such circumstances will be found in *Insurance Company v. Wilson*, 8 Pet. 291, 304, 305, 8 L. Ed. 949, where a peremptory mandamus was awarded against a district judge without any allowance of costs. We hardly need any authorities on such a proposition; but for convenience we refer again to Spelling's Extraordinary Remedies (2d Ed.) 1466.

Against whom then can costs be taxed? Undoubtedly, if, on the summons to show cause, or on any notice that they might appear, the adverse parties had come in and resisted the petition for mandamus on the merits, costs could have gone against them; but their position in this court was not of that character. It took the form of a motion to dismiss because the proceedings had become unnecessary. On being formally advised of the facts, this court acceded to the motion to dismiss made by them. They would, therefore, appear to be the prevailing parties, if there were any such; but there seems to be no substantial right to costs either way.

The petition of the Haight & Freese Company to revise the ruling of the clerk on its petition asking an allowance of costs is denied, and the ruling of the clerk denying costs is affirmed.

SEIGEL v. CARTEL et al.

(Circuit Court of Appeals, Eighth Circuit. October 19, 1908.)

No. 2,681.

1. BANKRUPTCY (§ 414*)—FAILURE OF BANKRUPT TO ACCOUNT FOR PROPERTY—PRESUMPTION.

Where a bankrupt falls to schedule or to surrender to his trustee goods shown to have been in his possession a short time prior to his bankruptcy, the burden rests upon him to account for the same, and, if he fails to do so, the presumption is that he sold them and conceals the proceeds.

[Ed. Note.—For other cases, see Bankruptcy, Dec. Dig. § 414.*]

2. BANKRUPTCY (§ 467*)—DISCHARGE—CREDIBILITY OF WITNESS—DISCRETION OF COURT.

Where the granting of a discharge to a bankrupt was objected to on the ground that he fraudulently concealed the proceeds of property sold, and there was reasonable ground for the action of the District Judge in discrediting his testimony in explanation, the exercise of his discretion will not be reviewed.

[Ed. Note.—For other cases, see Bankruptcy, Cent. Dig. § 929; Dec. Dig. § 467.*]

Appeal from the District Court of the United States for the Southern District of Iowa.

M. H. Cohen, for appellant.

N. T. Guernsey and C. F. Maxwell, for appellees.

Before SANBORN and HOOK, Circuit Judges, and PHILIPS, District Judge.

PHILIPS, District Judge. This is an appeal from an order of the District Court refusing the petition of the bankrupt for final discharge. There are six specifications of objections to the discharge. If any one is good in law and is sustained by sufficient evidence, the order and decree of the District Court must be affirmed.

The substance of the first objection is that the bankrupt, within the four months immediately preceding the filing of the petition in bankruptcy, for the purpose of hindering, delaying, and defrauding his creditors, transferred, removed, destroyed, and concealed, or permitted to be transferred, removed, destroyed, and concealed, certain of his assets; approximately \$11,000 worth of his stock of merchandise, consisting of furniture, stoves, carpets, etc. The evidence clearly enough shows that this merchant, between the 1st day of January, 1904, and August of that year, just preceding the proceeding in bankruptcy, disposed of between eleven and thirteen thousand dollars worth of goods. In other words, he was short that amount of stock at the time of the declared bankruptcy. He was called upon by the referee to account for these goods or their proceeds; the presumption being, as they were not on hand, that he had disposed of them and the proceeds were in his possession. *In re Deuell* (D. C.) 100 Fed. 633; *In re Cashman* (D. C.) 103 Fed. 67. Not having scheduled or surrendered the property to the trustee, the concealment of the proceeds, within the provi-

*For other cases see same topic & § NUMBER in Dec. & Am. Digs. 1907 to date, & Rep'r Indexes

sions of the statute, is presumed. In *re* Finkelstein (D. C.) 101 Fed. 418; In *re* Meyers (D. C.) 96 Fed. 408; In *re* Morgan (D. C.) 101 Fed. 982.

The only tangible explanation of this shortage of funds by the petitioner is that he lost the money in gambling at poker. His evidence was that he had long indulged this habit of gambling, and estimated that he had probably at different times lost an aggregate of \$100,000. As he seems to have been a most unlucky gambler, to say the least, it was not honest for him to thus take the proceeds of the goods he had purchased on credit to indulge his passion at the expense of his confiding creditors. While the statute does not deny the benefit of the bankrupt act (Act July 1, 1898, c. 541, 30 Stat. 544 [U. S. Comp. St. 1901, p. 3418]) to such a derelict, in administering the beneficent spirit of the act, the court, to prevent it becoming a covert to the delinquent undeserver, should see to it that his accounting is clear and free from reasonable doubt. He kept no book account of the withdrawal of this money or its disbursement. He did not introduce any evidence corroborative of the losses at gaming. He failed on close inquiry to give the name of one person with whom he played or the name of the proprietor of the establishment where he played, save one who was out of the state and last heard of at the St. Louis World's Exposition, thus making it quite impracticable, if not impossible, for the objecting creditors to contradict him. He could give no particular dates or particular sums lost at "the sittings." The credibility and reasonableness of his story were addressed to the judicial discretion of the District Judge. As there was, in our judgment, reasonable ground for discrediting his explanation, we will not review the exercise of that discretion. See *In re* Leslie (D. C.) 119 Fed. 406.

It results that the decree of the District Court must be affirmed.

NOOJIN v. UNITED STATES.

(Circuit Court of Appeals, Fifth Circuit. November 10, 1908.)

No. 1,751.

APPEAL AND ERROR (§ 78*)—APPEALABLE ORDERS—REFUSAL TO QUASH EXECUTION.

In the courts of the United States the refusal to quash an execution is not a final judgment, and cannot be reviewed on writ of error.

[Ed. Note.—For other cases, see Appeal and Error, Cent. Dig. § 479; Dec. Dig. § 78.*]

Finality of judgments and decrees for purposes of review, see notes to *Brush Electric Co. v. Electric Improvement Co. of San Jose*, 2 C. C. A. 379; *Central Trust Co. of New York v. Madden*, 17 C. C. A. 238; *Prescott & A. C. Ry. Co. v. Atchison, T. & S. F. R. Co.*, 28 C. C. A. 482.]

In Error to the Circuit Court of the United States for the Northern District of Alabama.

For opinion below, see 155 Fed. 377.

*For other cases see same topic & § NUMBER in Dec. & Am. Digs. 1907 to date, & Rep'r Indexes

P. E. Culli, for plaintiff in error.

Oliver D. Street and J. H. Montgomery, for defendant in error.

Before PARDEE and SHELBY, Circuit Judges, and BURNS, District Judge.

PER CURIAM. The writ of error in this case was brought to review the action of the court in denying a motion to quash an execution. In the courts of the United States the refusal to quash an execution is not a final judgment. *Boyle v. Zacharie*, 6 Pet. 635, 637, 8 L. Ed. 527; *Evans v. Gee*, 14 Pet. 1, 10 L. Ed. 327; *Loeber v. Schrader*, 149 U. S. 580, 585, 13 Sup. Ct. 934, 37 L. Ed. 856.

Writ of error dismissed.

MORTON v. LLEWELLYN et al.

(Circuit Court of Appeals, Ninth Circuit. October 19, 1908.)

No. 1,548.

1. PATENTS (§ 311*)—SUIT FOR INFRINGEMENT—DEFENSES—PLEADING.

The defendant in a suit for infringement of a patent must give notice in his answer of any defense by way of prior patents, publications, or public use relied on to show want of novelty or invention, otherwise such evidence is receivable only to show the state of the art, and to aid in the proper construction of the patent in suit.

[Ed. Note.—For other cases, see Patents, Cent. Dig. §§ 522, 529, 530; Dec. Dig. § 311.*]

2. PATENTS (§ 36*)—EVIDENCE OF INVENTION—SUCCESS OF DEVICE.

Apart from the presumption of novelty arising from the grant of a patent, where it is shown that the patented device has gone into general use and has superseded prior devices having the same purpose, it is sufficient evidence of invention in a doubtful case.

[Ed. Note.—For other cases, see Patents, Cent. Dig. § 40; Dec. Dig. § 36.*]

Utility, extent of use, and commercial success as evidence of invention, see note to *Doig v. Morgan Mach. Co.*, 59 C. C. A. 620.]

3. PATENTS (§ 328*)—INFRINGEMENT—DRAINAGE PIPE FITTINGS.

The Walker patents, No. 635,619 and No. 788,803, for soil pipe drainage and venting fittings, held valid as disclosing novelty and invention, but not infringed.

[Ed. Note.—For other cases, see Patents, Dec. Dig. § 328.*]

Appeal from the Circuit Court of the United States for the Southern Division of the Southern District of California.

George E. Harpham, for appellant.

Frederick S. Lyon, for appellees.

Before GILBERT, ROSS, and MORROW, Circuit Judges.

ROSS, Circuit Judge. This suit was brought by the appellees against the appellant for the alleged infringement of two certain letters patent, the first No. 635,619, issued October 24, 1899, for a combination soil pipe drainage and venting fitting, and the other, No. 788,803, issued May 2, 1905, for a sanitary drainage and vent fitting, to the appellee Walker, who thereafter assigned one-half of his inter-

*For other cases see same topic & § NUMBER in Dec. & Am. Digs. 1907 to date, & Rep'r Indexes

est therein to his co-appellee, Llewellyn. In answering the bill of complaint, the appellant, who was the defendant below, alleged, among other things:

"That the pretended improvement and new discovery of fittings as set out in said complaint, and as mentioned in said letters patent therein referred to, was not new when produced by said plaintiff, but was known and previously patented and described in printed publication prior to the alleged invention thereof by the said plaintiffs; that is to say, the said fittings were patented previously in and by the following letters patent of the United States of America: No. 577,793, A. C. Stewart, February 23, 1897. And said letters patent referred to and said fittings were previously patented by said A. C. Stewart in the United States in the year 1885, the exact date of which is unknown to the defendant, but which he prays to leave to insert upon being informed of the date. Defendant, further answering, avers that he is informed and believes that the said A. C. Stewart and a number of other persons whose names are unknown to the plaintiff had previous knowledge for more than two years of substantially the same fittings patented by the said plaintiffs prior to the alleged discovery and invention thereof by said plaintiff, and that defendant himself used substantially the thing patented in the county of Los Angeles, state of California, and elsewhere, previous to the issuing of the letters patent to said plaintiffs; and aver, on information and belief, that an apparatus substantially identical with the fittings alleged to be * * * invented by said plaintiff was known and generally used throughout the country for more than two years previous to the application for the letters patent referred to in plaintiffs' complaint, and that said improvements were known and used by others in this country for more than two years, and were described in other printed publications in this and other countries for more than two years prior to the alleged invention thereof by said plaintiff, the names and residences of said certain other persons having such prior knowledge and making such prior use are at present unknown to the defendant, and therefore prays your honors that, so soon as they may reasonably obtain information sufficient to set forth those matters in detail, they may be permitted to do so, by amended answer or otherwise, as to your honors shall seem meet."

The law is well settled that the defendant to a suit for infringement must give notice in his answer of any defense by way of prior patents, publications, or public use, if he desires to prove any of such defenses to show want of novelty or invention in the patent sued on. Otherwise such defenses are receivable in evidence only to show the state of the art, and to aid in the proper construction of the patent. *Grier v. Wilt*, 120 U. S. 412, 7 Sup. Ct. 718, 30 L. Ed. 712; *Vance v. Campbell*, 1 Black, 427, 430, 17 L. Ed. 168; *Railroad v. Du Bois*, 12 Wall. 47, 65, 20 L. Ed. 265; *Brown v. Piper*, 91 U. S. 37, 41, 23 L. Ed. 200; *Eachus v. Broomall*, 115 U. S. 420, 434, 6 Sup. Ct. 229, 29 L. Ed. 419. The only anticipating patent, printed publication, or device set up in the answer is that issued to Stewart, which in the brief of the appellant is not relied upon at all, but it is there contended that certain exhibits, numbered 1 and 2, and concerning which some of the defendant's witnesses were questioned, show that a similar device to that of Walker was in general use 16 and more years prior to his patents.

The purpose of the fitting covered by the first Walker patent was thus described by the patentee:

"One object of my invention is to provide a fitting for use in drainage and venting plumbing of buildings which will combine in one piece means for attaching to the discharge-fitting of the basin, bath, or other fixture to be

drained, and means for venting such drainage pipe into a main venting-line adapted to vent connections at a lower point thereon.

"Another object of my invention is to provide a drainage and venting fitting which will discharge the liquids from the basin, bath, or other fixture downwardly into the drainage or soil pipe to prevent such water from splashing or from damming against an opposite incoming stream where two streams enter from opposite sides of the pipe.

"Another object of my invention is to provide means whereby two parallel lines of pipe, one of which is used as a soil or drainage pipe and the other one used as a vent pipe, may be joined in an inexpensive manner, so that the soil pipe is vented into the vent-pipe without danger of the drainage flowing over the basin or other fixture onto the floor. I accomplish this by having the upper end of my venting duct terminate and connect with the vent pipe at a point on a level intermediate the top and bottom of the basin or other fixture. Should there be any backflow of water from a stoppage of the drain pipe, it will run out into the vent pipe before rising to the top of basin or other fixture and will show water in the bottom of basin at the same time, which would indicate a stoppage of drain pipe. While I consider this construction preferable, it is to be understood that I do not limit myself to such proportions, but may make the fitting of any length.

"My fitting comprises a soil pipe member straight throughout, a vent pipe member straight throughout parallel with the soil pipe member, and a drainage receiving and venting duct connecting the lower portion of the soil pipe member and the upper portion of the vent pipe member.

"My invention also includes a drainage and venting fitting comprising a soil pipe member, a vent pipe member connected therewith, and a deflector arranged to discharge the drainage downwardly into the soil pipe member."

The subsequent specifications were followed by these claims:

"1. An integral drainage and venting fitting comprising two substantially parallel members open throughout and each adapted at each end to connect with upper and lower pipes, and a connecting member substantially parallel with the said first-named members and opening from the one member at one end of the fitting and into the other member at the other end of the fitting.

"2. A drainage and venting fitting comprising a soil pipe member straight throughout; a vent pipe member straight throughout and parallel with the soil pipe member; a drainage receiving and venting duct connecting at its lower end with the lower part of the soil pipe member and at its upper end with the upper part of the vent pipe member and also provided near its lower end with lateral openings to receive the drainage.

"3. A drainage and venting fitting comprising a soil pipe member; a vent pipe member connected therewith; a lateral drainage discharge arranged to discharge into the drainage and vent pipe member, and an inclined deflector arranged inside of the drainage and vent pipe member above and over the lateral drainage discharge to direct the water downwardly.

"4. A drainage and venting fitting comprising a soil pipe member straight throughout; a vent pipe member straight throughout parallel with the soil pipe member; a vent and drainage duct connecting the soil pipe member and the vent pipe; a lateral drainage discharge arranged to discharge into the vent and drainage duct; and an inclined deflector arranged inside of the drainage and vent duct above and over the lateral drainage discharge to direct the water downwardly.

"5. A drainage and venting pipe provided in its length with an enlargement; a lateral drainage-receiving opening or openings in the enlargement; and inclined deflectors projecting out from the wall of the enlargement over such openings, the lower ends of said deflectors extending out beyond the inner wall of the pipe, whereby the incoming stream has a free outlet and is directed downwardly into the pipe, substantially as described."

In the appellees' patent No. 788,803 the purpose of the sanitary drainage and vent fitting was thus stated by the patentee:

"This invention relates to a fitting adapted particularly for use in connection with soil pipes, drainage stacks, or standpipes and vents therefor.

"The main object of the present invention is to provide a fitting for this purpose of extreme compactness, strength, and cheapness.

"A special object of the invention in this connection is to provide a fitting that is sufficiently compact to be wholly inclosed within the wall or floor structure and will not project into the room.

"A further object of the invention is to provide a fitting of this character with means for preventing a condition of suction therein.

"When drainage connections are applied to several superimposed floors, it sometimes happens that a simultaneous flush or run-off from several floors will cause a congestion within the fittings in one or more of the lower floors and consequent suction effect therein, with the result that one or more of the closets on the lower floors will be siphoned off. The present invention prevents such objectionable action by providing in each fitting means for access of air to the interior thereof in such manner as to break any vacuum that tends to form."

Following the specifications in this second patent are the following claims:

"1. A double drainage fitting consisting of a soil pipe section having a central chamber with lateral downwardly-curved inlet branches, the upper side of said branches terminating inside the chamber in deflectors at a point which is lower than the center of the inlets of the drainage branches.

"2. A drainage and ventilating fitting comprising a tubular body with a main chamber provided with lateral drainage branches extending thereinto, deflectors extending downwardly from the respective lateral branches into the main chamber, and a vent chamber communicating with the main chamber below the deflectors.

"3. A drainage and ventilating fitting comprising a main chamber with inlet and outlet branches at top and bottom, lateral drainage branches extending obliquely downward thereinto at each side, a vent chamber extending obliquely upward from the main chamber, and opening into each of the drainage branches.

"4. A drainage and ventilating fitting comprising a main chamber with inlet and outlet branches at top and bottom, lateral drainage branches extending obliquely downward thereinto at each side, a vent chamber extending obliquely upward from the main chamber and opening into each of the drainage branches, said vent chamber flaring upwards and communicating with the main chamber through an upwardly-flaring opening.

"5. A drainage and ventilating fitting comprising a main chamber having inlet and outlet portions at top and bottom, curved drainage branches leading obliquely downward into said drainage chamber, the upper walls of the branches terminating in deflectors extending obliquely inward and downward from the drainage branches into the main chamber, and a vent chamber opening into the main chamber below said deflectors and extending obliquely upward.

"6. A double drainage fitting consisting of a soil pipe section having a main chamber having inlet and outlet portions at top and bottom, curved drainage branches leading obliquely downward into said drainage chamber, the upper walls of the branches terminating in deflectors extending obliquely inward and downward from the drainage branches into the main chamber, and a vent pipe opening into the main chamber between said deflectors.

"7. A double drainage fitting consisting of a soil pipe section having a central chamber with lateral downwardly-curving inlet branches, the upper side of said branches terminating inside the chamber in deflectors at a point which is lower than the center of the inlets of the drainage branches and a hub extending outwardly from the fitting for the purpose stated.

"8. A drainage and ventilating fitting comprising a main chamber with inlet and outlet branches at top and bottom, lateral drainage branches extending obliquely downward thereinto at each side, a vent chamber extending obliquely upward from the main chamber, and opening into each of the

drainage branches and a hub extending outwardly from the fitting for the purpose stated."

The patentee testified that he manufactured and sold fittings embodying the construction set forth in each of his patents, exhibits of which he produced and introduced in evidence, and that he had already sold in the aggregate about \$30,000 worth of the fittings, and in answer to a question as to the extent that the fittings made by him embodying the construction set forth in letters patent No. 635,619 had been used, answered:

"They have been used quite extensively, and have superseded the old style double fittings. I am also sending them up to Portland, Victoria, San Francisco, and San Jose."

We find no contradiction of this testimony in the record. Apart from the presumption of novelty that always attends the grant of a patent, the law is that where it is shown that a patented device has gone into general use, and has superseded prior devices having the same purpose, it is sufficient evidence of invention in a doubtful case. *The Barbed Wire Patent*, 143 U. S. 275, 292, 12 Sup. Ct. 443, 36 L. Ed. 154; *Keystone Manufacturing Company v. Adams*, 151 U. S. 139, 143, 14 Sup. Ct. 295, 38 L. Ed. 103; *Irwin v. Hasselman*, 97 Fed. 964, 38 C. C. A. 587; *Wilkins Shoe Button Co. v. Webb* (C. C.) 89 Fed. 982; *National Hollow B. B. Co. v. Interchangeable B. B. Co.*, 106 Fed. 693, 707, 45 C. C. A. 544.

In the light of these rules of law, and of the foregoing facts, we are to consider Exhibits 1 and 2, relied on by the appellant as showing the state of the art at the time the patents in question were granted to Walker. A careful comparison of those exhibits with the patented fittings satisfies us that the only elements of novelty in the latter are the inclined deflectors within the drainage pipe and vent, and the enlargement of the latter, neither of which elements do we find in the appellant's fitting. The latter, with the exception of a change of angles and a shortening of the arms, is exactly similar to Exhibits 1 and 2. It may be, and probably is, true that the deflectors and enlargement of the appellees' fittings and their compactness makes them more desirable, and no doubt accounts for the favor they are shown to meet in the markets; but that circumstance is unimportant since, in our opinion, the appellant is not shown to have infringed. While, therefore, we think the court below was right in sustaining the validity of the patents sued on, we must reverse its judgment for want of infringement.

The judgment is reversed, and the cause remanded to the court below, with directions to dismiss the bill at complainant's cost.

WINFREE v. NORTHERN PAC. RY. CO.

(Circuit Court, E. D. Washington, E. D. September 5, 1908.)

No. 1,344.

MASTER AND SERVANT (§ 87*)—EMPLOYER'S LIABILITY ACT—RETROACTIVE OPERATION—"ACTION HEREAFTER BROUGHT."

The provisions of Act April 22, 1908, c. 149, 35 Stat. pt. 1, p. 65, relating to the liability of common carriers by railroad to their employes, are prospective only in their operation, and the phrase "actions hereafter brought," as used in section 3, does not apply to an action by an employe for an injury received before the statute was enacted.

[Ed. Note.—For other cases, see Master and Servant, Dec. Dig. § 87.*]

At Law. On demurrer to complaint.

B. C. Mosby, for plaintiff.

Edward J. Cannon, for defendant.

WHITSON, District Judge. It is alleged that the plaintiff's intestate met his death on the 3d day of July, 1906, through the wrongful acts of the defendant while engaged as one of its employes, for which damages are demanded. Plaintiff relies upon the act of Congress approved April 22, 1908, entitled "An act relating to the liability of common carriers by railroad to their employes in certain cases." 35 Stat. pt. 1, p. 65, c. 149.

The point made by the defendant on demurrer to the complaint is that the grievance complained of antedates the passage of the statute. Passing over the familiar doctrine that the intention to give a statute retroactive effect must clearly appear before it will be so construed, we are confronted with a more serious phase of statutory construction, namely, whether the defendant would be deprived of rights which it enjoyed at the time of the accident by applying the statute subsequently passed to the occurrences set out in the complaint.

To sustain the action under the statute the decision of Judge Hanford in *Plummer v. Northern Pacific Railway Company* (C. C.) 152 Fed. 206, has been cited; but the holding in that case was that the employer's liability act of June 11, 1906 (34 Stat. 232, c. 3073), created "a new right and a new obligation," by reason of which it could not be construed to operate retroactively. In this view I fully concur. Certainly the explicit and sweeping provisions of the later act are subject to no other construction. Section 1 creates a liability where none existed before, by providing for a recovery when injury results in whole or in part "from the negligence of any of the officers, agents or employes of such carrier. * * *" Section 3 provides that contributory negligence shall not bar a recovery, while section 4 is at least a radical modification of the rule relating to the assumption of risk which existed prior to its adoption.

Here the plaintiff avowedly seeks to recover upon a state of facts which would not have entitled him to a judgment at the time the

*For other cases see same topic & § NUMBER in Dec. & Am. Digs. 1907 to date, & Rep'r Indexes

right accrued. This would deprive the defendant of something substantial, and confer upon the plaintiff a benefit which was not existent and could not have been in contemplation of the parties when the relation of employer and employé was entered into. Since it cannot be supposed that Congress intended to disturb existing rights, it must be held that the statute was intended to be prospective in its operation, and that the language of section 3, "that in all actions hereafter brought," was intended to refer to causes of action arising after the passage of the act.

Demurrer sustained.

THE RANZA.

(District Court, E. D. Pennsylvania. October 17, 1908.)

No. 32.

SHIPPING (§ 86*)—INJURY OF STEVEDORE—LIABILITY OF VESSEL.

Evidence *held* not to sustain the allegation of a libel that the injury of libelant while employed by a stevedore in discharging a vessel was due to defects in the winch, supplied by the vessel, which would render her liable therefor.

[Ed. Note.—For other cases, see Shipping, Dec. Dig. § 86.*]

In Admiralty.

Jos. H. Brinton, for libelant.

Henry R. Edmunds and Convers & Kirlin, for respondent.

J. B. McPHERSON, District Judge. On September 8, 1905, the libelant, Robert E. Tabbenor, was assisting as a laborer under W. G. Grace, a master stevedore, in discharging a cargo of iron ore from the steamship Ranza. He was working in No. 1 hold, and his duty was to fill buckets with the ore as they were lowered into the hold. The winch, the wire fall to which the buckets were attached, and the steam, were furnished by the ship; but the operation of the winch was in charge of another laborer, who was also in the employ of Mr. Grace. The averments of the libel concerning the injury which Tabbenor declares he sustained on the day in question are as follows:

"About 4 o'clock a. m., the libelant, having assisted in filling a bucket, stood as far from beneath the same as possible while it was being raised to the combings. When said bucket was raised nearly flush with the combings the steam winch lost control, and the bucket fell violently for a distance of several feet, the jerking of which caused part of the contents of the bucket to fall and strike the libelant on his right foot, whereby he suffered severe injuries. That the cause of the injuries was solely attributable to the defective condition of the winch, which defective condition was known to the master and officers of the said vessel, who had failed to remedy or attempt to remedy the same.

"That the said steam windlass and wire fall were supplied by the respondents for the uses to which it was applied, and was known by them to be in an old, weak, defective, and unsuitable condition for the said purpose.

"That the libelant exercised due care and precaution and in no manner contributed to the said injuries, but the same were solely caused by the negli-

*For other cases see same topic & § NUMBER in Dec. & Am. Digs. 1907 to date, & Rep'r Indexes

gence and carelessness of the respondents in supplying the defective appliances aforesaid."

The only testimony to support these averments was given by the libellant himself, and it fails entirely to establish the charge that the winch was out of order. There is a little hearsay testimony upon the subject, but no competent evidence from which the inference of negligence on the part of the ship can be drawn. It would be useless to discuss the testimony in detail.

The clerk is directed to enter a decree dismissing the libel.

UNITED STATES v. AMERICAN TOBACCO CO. et al.

(Circuit Court, S. D. New York. November 7, 1908.)

1. MONOPOLIES (§ 12*)—“COMBINATIONS IN RESTRAINT OF INTERSTATE COMMERCE.”

Every combination which restrains free competition in interstate trade is a combination in restraint of interstate commerce, in violation of Sherman Act July 2, 1890, c. 647, § 1, 26 Stat. 209 (U. S. Comp. St. 1901, p. 3200).

[Ed. Note.—For other cases, see Monopolies, Cent. Dig. § 10; Dec. Dig. § 12.*

For other definitions, see Words and Phrases, vol. 2, pp. 1275-1276; vol. 8, p. 7606.]

2. MONOPOLIES (§ 20*)—“COMBINATION IN RESTRAINT OF INTERSTATE COMMERCE”—CONSOLIDATION OF COMPETING CORPORATIONS.

The consolidation into one corporation of a large number of corporations engaged in the different branches of the tobacco industry, many of which were previously active competitors in interstate and foreign commerce, with the result of eliminating such competition and of giving the consolidated company control of at least 75 per cent. of the entire manufactured tobacco business of the United States, including the interstate trade therein, constitutes a “combination in restraint of interstate commerce,” in violation of Sherman Act July 2, 1890, c. 647, § 1, 26 Stat. 209 (U. S. Comp. St. 1901, p. 3200).

[Ed. Note.—For other cases, see Monopolies, Dec. Dig. § 20.*]

3. COMMERCE (§ 40*)—“INTERSTATE COMMERCE”—WHAT CONSTITUTES.

A corporation engaged in the manufacture and sale of tobacco in its various forms, which purchases its raw materials and supplies in different states and in foreign countries, and ships them by means of common carriers into other states for manufacture, and its products from one state into another between its different factories and agencies, and sells the same by means of agencies and salesmen throughout the United States and in the markets of the world, is engaged in “interstate commerce,” and it is immaterial that it distributes its products by means of common carriers or that the title technically passes on delivery to such carriers.

[Ed. Note.—For other cases, see Commerce, Cent. Dig. §§ 29, 30; Dec. Dig. § 40.*

For other definitions, see Words and Phrases, vol. 4, pp. 3724-3731.]

4. MONOPOLIES (§ 17*)—COMBINATIONS IN RESTRAINT OF INTERSTATE COMMERCE—SUBSIDIARY CORPORATION—“UNLAWFUL MONOPOLY.”

A corporation engaged in selling tobacco products at retail is not rendered unlawful by the fact that a majority of its stock is owned by another corporation, which is itself an unlawful combination in restraint of interstate commerce, and which sells to the retailing corporation the

*For other cases see same topic & § NUMBER in Dec. & Am. Digs. 1907 to date, & Rep'r Indexes

larger part of its goods, where the latter conducts its business independently in a lawful manner, and sells also goods of other manufacturers. Nor does it constitute an "unlawful monopoly," in violation of Sherman Act July 2, 1890, c. 647, § 2, 26 Stat. 209 (U. S. Comp. St. 1901, p. 3200), because it operates in the several states 400 retail stores out of 600,000 places where tobacco is sold.

[Ed. Note.—For other cases, see Monopolies, Dec. Dig. § 17.*]

Ward, Circuit Judge, dissenting.

In Equity.

J. C. McReynolds and Edwin P. Grosvenor, Sp. Asst. Attys. Gen., for complainant.

William J. Wallace, W. W. Fuller, Delancey Nicoll, and Junius Parker, for American Tobacco Co. and constituent companies.

William B. Hornblower, W. W. Miller, Morgan M. Mann, and John Pickrell, for Imperial Tobacco Co.

Charles R. Carruth, for R. P. Richardson, Jr., & Co., Inc.

Stroock & Stroock (S. M. Stroock, of counsel), for United Cigar Stores Co.

Before LACOMBE, COXE, WARD, and NOYES, Circuit Judges.

LACOMBE, Circuit Judge. Act July 2, 1890, c. 647, 26 Stat. 209 (U. S. Comp. St. 1901, p. 3200), in its first section, declares to be illegal "every contract, combination in the form of trust or otherwise, or conspiracy, in restraint of trade or commerce among the several states, or with foreign nations." That declaration, ambiguous when enacted, is, as the writer conceives, no longer open to construction in the inferior federal courts. Disregarding various dicta and following the several propositions which have been approved by successive majorities of the Supreme Court, this language is to be construed as prohibiting any contract or combination whose direct effect is to prevent the free play of competition, and thus tend to deprive the country of the services of any number of independent dealers however small. As thus construed the statute is revolutionary. By this it is not intended to imply that the construction is incorrect. When we remember the circumstances under which the act was passed, the popular prejudice against large aggregations of capital, and the loud outcry against combinations which might in one way or another interfere to suppress or check the full, free, and wholly unrestrained competition which was assumed, rightly or wrongly, to be the very "life of trade," it would not be surprising to find that Congress had responded to what seemed to be the wishes of a large part, if not the majority, of the community, and that it intended to secure such competition against the operation of natural laws. The act may be termed revolutionary, because, before its passage, the courts had recognized a "restraint of trade" which was held not to be unfair, but permissible, although it operated in some measure to restrict competition. By insensible degrees, under the operation of many causes, business, manufacturing and trading alike, has more and more developed a tendency toward larger and larger aggregations of capital and more extensive com-

*For other cases see same topic & § NUMBER in Dec. & Am. Digs. 1907 to date, & Rep'r Indexes

binations of individual enterprise. It is contended that, under existing conditions, in that way only can production be increased and cheapened, new markets opened and developed, stability in reasonable prices secured, and industrial progress assured. But every aggregation of individuals or corporations, formerly independent, immediately upon its formation terminates an existing competition, whether or not some other competition may subsequently arise. The act as above construed prohibits every contract or combination in restraint of competition. Size is not made the test: Two individuals who have been driving rival express wagons between villages in two contiguous states, who enter into a combination to join forces and operate a single line, restrain an existing competition; and it would seem to make little difference whether they make such combination more effective by forming a partnership or not.

Accepting this construction of the statute, as it would seem this court must accept it, there can be little doubt that it has been violated in this case. The formation of the original American Tobacco Company, which antedated the Sherman act, may be disregarded. But the present American Tobacco Company was formed by subsequent merger of the original company with the Continental Tobacco Company and the Consolidated Tobacco Company, and when that merger became complete two of its existing competitors in the tobacco business were eliminated.

What benefits may have come from this combination, or from the others complained of, it is not material to inquire, nor need subsequent business methods be considered, nor the effects on production or prices. The record in this case does not indicate that there has been any increase in the price of tobacco products to the consumer. There is an absence of persuasive evidence that by unfair competition or improper practices independent dealers have been dragooned into giving up their individual enterprises and selling out to the principal defendant. In this connection interesting testimony is given by one of the government's witnesses. The deponent was for many years an independent dealer and secretary of the Independent Tobacco Manufacturers' Association. He testified:

"My business was conducted by me alone. I had no partner, no corporation. It had got to be a large business, and if anything happened to me there was no one there to continue it. The value of the business was in a brand, and I became fearsome what would happen to it if I would be disabled in any way. It would not be much value to my estate unless some one had a knowledge of the business and knew how to manage it, and then I believed there was a maximum business beyond which you cannot conduct it profitably personally. It will get so big that it requires an organization. And then, too, I was only identified as a scrap tobacco manufacturer; and, going by precedent, the consuming public of tobacco changes every 10, 12, or 15 years, and I have figured that might happen again, and it wouldn't use scrap tobacco, and might use something else, and then I would not have much business, I thought; whereas the American Tobacco Company had been in conference with me, I knew the officers, and I made up my mind, when a proper proposition was made to me, such as was satisfactory to me, I would be very anxious to affiliate myself with a good, big tobacco organization, large enough and strong enough to take care of all conditions that might come up. I was not induced to sell out by a decrease of profits or by any unfair competition. I never had any fear they could drive me out of business."

During the existence of the American Tobacco Company new enterprises have been started, some with small capital, in competition with it, and have thriven. The price of leaf tobacco—the raw material—except for one brief period of abnormal conditions, has steadily increased, until it has nearly doubled, while at the same time 150,000 additional acres have been devoted to tobacco crops and the consumption of the leaf has greatly increased. Through the enterprise of defendant and at large expense new markets for American tobacco have been opened or developed in India, China, and elsewhere. But all this is immaterial. Each one of these purchases of existing concerns, complained of in the petition, was a contract and combination in restraint of a competition existing when it was entered into, and that is sufficient to bring it within the ban of this drastic statute.

A large part of the record is taken up with testimony as to concealment of the relations existing between some of the defendants. It is difficult to see what bearing this has on the questions in controversy. If an agreement by a corporation to acquire a majority of the stock in a competing corporation is obnoxious to the statute, its vice is certainly not eradicated by the promptest publicity. If, on the other hand, such an agreement is innocent, it does not become guilty merely because the parties to it keep their own counsel about their mutual transactions.

It is contended that the case at bar is not within the statute, since the various combinations complained of deal primarily with manufacture; and *United States v. Knight*, 156 U. S. 1, 15 Sup. Ct. 249, 39 L. Ed. 325, is cited in support of that proposition. It seems to the writer, however, that subsequent decisions of the Supreme Court have modified the opinion in that case, and that the one at bar is as much within the statute as was the combination condemned in *Loewe v. Lawlor*, 208 U. S. 274, 28 Sup. Ct. 301, 52 L. Ed. 488. Relief under the statute should be granted against the several domestic corporations defendant.

The Imperial Tobacco Company of Great Britain and Ireland, Limited, is one of the defendants. It is a British corporation and entered into a contract with the American Tobacco Company in the city of London, where such contract was a legal and proper one. It is apparently the contention of petitioner that subsequent acts of the Imperial Tobacco Company in this country practically amount to the entering into a combination or contract of the sort specified in the statute. So far as appears the only transactions of that company here are these: It buys leaf tobacco of the American grower in very large quantities by its own independent force of purchasing employés. It does not sell its manufactured products here—indeed, such products, having to pay both tariff duties and revenue tax, could not be sold here except at a loss, save in the case of a few fancy high-priced brands. It may be an enlightened public policy to prohibit an alien corporation from buying its raw material in this country unless it sends its products here to compete with American manufacturers; but, if it be, this act seems not to have gone to that extent. The petition should be dismissed as to the Imperial Tobacco Company. A like disposition should be made as to the British-American Company.

As to relief: In the main brief it is prayed that the domestic defendants the American Tobacco Company, American Snuff Company, and others enumerated, should be restrained from carrying on interstate or foreign commerce until conditions existing before illegal contracts or combinations were entered into are restored. Such relief is certainly drastic enough and should be efficient. In the petition it is prayed that receivers be appointed for the various companies, who apparently are to conduct a tobacco business and create some sort of artificial competition to take the place of the natural competition which, it is alleged, was destroyed by the combinations. Such a scheme seems impracticable and is wholly unnecessary.

I concur with Judge COXE in his reasoning and conclusions touching the United Cigar Stores Company and the R. P. Richardson, Jr., Company, and agree that issuance of injunction should be suspended until after decision on appeal.

COXE, Circuit Judge (concurring). As we are unanimous in thinking that the testimony shows no case for a receiver and that the bill should be dismissed as to the defendants, the Imperial Tobacco Company and the British American Company, nothing need be added to what Judge LACOMBE has written in arriving at these conclusions. I concur with him in the result reached as to the other defendants except in some minor particulars which will be noted hereafter.

The "Tobacco Trust," so called, consists of over 60 corporations, which, since January, 1890, have been united into a gigantic combination which controls a greatly preponderating proportion of the tobacco business in the United States in each and all its branches; in some branches the volume being as high as 95 per cent. Prior to their absorption many of these corporations had been active competitors in interstate and foreign commerce. They competed in purchasing raw materials, in manufacturing, in jobbing and in selling to the consumer. To-day those plants which have not been closed, are, with one or two exceptions, under the absolute domination of the supreme central authority. Everything directly or indirectly connected with the manufacture and sale of tobacco products, including the ingredients, the packages, the bags and boxes, are largely controlled by it. Should a party with moderate capital desire to enter the field it would be difficult to do so against the opposition of this combination. That many of the associated corporations were not coerced into joining the combination but entered of their own volition is quite true, but in many other instances it is evident that if not actually compelled to join, they preferred to do so rather than face an unequal trade war in which the odds were all against them and in which success could only be achieved by a ruinous expenditure of time and money.

The power to destroy a too formidable rival, assuming that the allied companies see fit to exercise it, can hardly be denied. We are not dealing with these companies as they existed prior to 1890 but with the consolidated unit controlling a preponderating proportion of the tobacco business in its most minute details. Prior to that date the manufacturing companies, the purchasers, the distributors and

the selling companies were each and all operating independently and tobacco products were being transported back and forth to every state of the Union and to foreign countries. Since 1890 this vast interstate and foreign trade which was formerly carried on by this large number of competing companies and individuals is now carried on by one combination. The free interchange of commerce has been interfered with, hampered, diverted and, in some instances, destroyed. Though it may be greater in volume it does not flow through the old channels, it is not free and unrestrained. It may be true that there are individual members of this combination not engaged in interstate commerce—manufacturing companies merely and therefore not engaged in commerce within the rule enunciated in *United States v. E. C. Knight Co.*, 156 U. S. 1, 15 Sup. Ct. 249, 39 L. Ed. 325. But here the complaint is made not against the individual conspirators separately but against the combination as a whole. Has it monopolized or restrained any part of interstate or foreign commerce? If so, it would seem that it is liable under the act. To illustrate, A. is a manufacturer of tobacco in New York, B. is a buyer of raw material in Kentucky, C. is a jobber in Pennsylvania and D. is a retailer in Boston. B. sends the leaf tobacco from Louisville to New York, A. manufactures it into smoking and chewing tobacco and sends it to C. at Philadelphia, who in turn ships it to D. at Boston, who sells it to the public. Should A., B., C. and D. enter into a copartnership to do as a firm what they had hitherto done as individuals can there be a doubt that the firm would be engaged in interstate commerce?

The defendants, with the exception of the Imperial Company, the Cigar Stores Company and the Richardson Company, admit as follows:

"We admit that all the vendors and corporation defendants mentioned in the petition as engaged in the manufacture and sale of tobacco products, except Imperial Tobacco Co., Ltd., purchased or now purchases some or all of the requisite raw material in states or countries other than those in which the factories were or are located, and had or has it transported thence through the medium of common carriers to said factories, and employed or employ traveling salesmen who solicited or solicit in states or countries other than those in which the factory was or is located, orders for the tobacco products which by them were or are transmitted to said factory or other chief office of the manufacturer, and, if approved, they are filled by the delivery of the goods to a common carrier where the factory was or is located, duly consigned to the purchaser, title passing to said purchaser on said delivery to the common carrier."

If the contention of the defendants, that this does not constitute interstate commerce be correct, then it would seem to follow that no one can be engaged in such commerce unless he be a carrier, common or private, between the states. In the illustration just given it seems to be conceded, if one of the partners had been a common carrier owning a ferry, for instance, by which the goods were carried across the Ohio river, and this business had been taken over with the rest, that the firm would be engaged in interstate commerce. If, however, it employs others to carry its goods from state to state it is argued that it is not so engaged. In other words, although the so-called "Tobacco Trust" is buying raw material and selling its completed products in the mar-

kets of the world, it is not engaged in "trade or commerce among the several states or with foreign nations" because carriers are employed to convey the goods from state to state and to foreign countries. I cannot but think that this is too narrow a construction. Should it obtain, the statute will be eviscerated. No matter how odious or complete the monopoly, it will be immune from punishment if it can show that others have been employed to distribute its goods.

It is not an answer to say that the remedy may be applied by the states, for the reason that by the Constitution, to Congress is delegated the sole power "to regulate commerce with foreign nations, and among the several states, and with the Indian tribes." In this domain the law of the national legislature is supreme and the states have no power to interfere. Dealing as it does with national and international commerce, the law must be unaffected by local conditions and it must be uniform. The conditions surrounding interstate commerce differ so materially in the various sections of the Union that it is not to be expected that anything like uniformity can obtain without the action of Congress.

At present the state laws are not harmonious and are as numerous as the states. In some of the states the tendency is to encourage commerce, in others to harass it with vexatious requirements. The framers of the Constitution were well aware of all this when they relegated the control of interstate commerce to the exclusive control of the national legislature.

The duty of this court is to ascertain the true meaning of the anti-trust act as expounded by the Supreme Court and, as so interpreted, to enforce it.

The Knight Case, *supra*, which is principally relied on by the defendants was the first case under the act to reach the Supreme Court. It was decided in January, 1895, and held in substance that the combination of a number of refineries to manufacture sugar was not within the act because manufacture alone is not commerce and therefore not within the control of Congress. The facts are similar to those relating to the absorption of several of the corporations in the case before us but not similar to all for the reasons which have been alluded to. In the Knight Case it was held that commerce was only incidentally affected. Mr. Justice Harlan in his dissenting opinion thus defines interstate commerce:

"Interstate commerce does not, therefore, consist in transportation simply. It includes the purchase and sale of articles that are intended to be transported from one state to another—every species of commercial intercourse among the states and with foreign nations."

The facts clearly bring the case at bar within this definition for the raw materials and the manufactured products were not only intended to be transported from one state to another but actually were transported, in many instances, before the title had passed from the manufacturer to the jobber, retailer or consumer. It is interesting to note that the Chief Justice, who wrote the opinion of the court in the Knight Case, also wrote the unanimous opinion in *Loewe v. Lawlor*, 208 U. S. 274, 28 Sup. Ct. 301, 52 L. Ed. 488, which is the latest exposition of the law.

An examination of the numerous decisions since the Knight Case leads to the conclusion that there has been a general tendency towards a broader and more liberal construction of the statute. In the Northern Securities Case, 193 U. S. 197, 24 Sup. Ct. 436, 48 L. Ed. 679, the opinion is written by Mr. Justice Harlan who dissented in the Knight Case. The previous decisions of the court are by him carefully reviewed and the point ruled in each is clearly stated. Of the Knight Case it is said:

"It was held that the agreement or arrangement there involved had reference only to the manufacture or production of sugar by those engaged in the alleged combination, but if it had directly embraced interstate or international commerce, it would then have been covered by the anti-trust act and would have been illegal."

He reviews all the prior decisions and formulates certain propositions which, in his opinion, are plainly deducible therefrom (page 331 of 193 U. S., page 436 of 24 Sup. Ct. [48 L. Ed. 679]). Some of these are as follows:

The anti-trust act embraces and declares to be illegal every contract combination or conspiracy, in whatever form, of whatever nature and whoever may be the parties to it, which directly or necessarily operates in restraint of interstate or international trade or commerce. The act is not limited to unreasonable restraints but embraces all direct restraints.

The natural effect of competition is to increase commerce and an agreement whose direct effect is to prevent this play of competition restrains trade and commerce. To vitiate such an agreement or combination it is not necessary to prove a total suppression of trade. It is only essential to show that by its necessary operation it tends to restrain interstate or international trade or commerce or tends to create a monopoly in such trade or commerce and to deprive the public of the advantages that flow from free competition.

Of course the facts in the Northern Securities Case differ essentially from those in the case at bar; but the language used in the opinion leaves little doubt that had the present combination been before the court, the majority would have declared it illegal. For instance the court says (page 337 of 193 U. S., page 457 of 24 Sup. Ct. [48 L. Ed. 679]):

"In all the prior cases in this court the anti-trust act has been construed as forbidding any combination which by its necessary operation destroys or restricts free competition among those engaged in interstate commerce; in other words, that to destroy or restrict free competition in interstate commerce was to restrain such commerce."

In *Loewe v. Lawlor* the court held the act applicable to members of a labor organization who by means of a boycott were endeavoring to destroy the business of a manufacturer of hats. The defendants were in no way engaged in interstate trade or commerce and the plaintiffs made hats in Connecticut and sold them in that and other states. So far as the business affected is concerned, the only distinction between the Knight Case and the *Loewe-Lawlor* Case is that in one the acts complained of related to the manufacture and sale of sugar and in the other to the manufacture and sale of hats.

The act cannot be invoked unless interstate or foreign trade or commerce is involved, and the court decided that interstate commerce was involved in *Loewe and Lawlor* although the case was presented on demurrer to the complaint, which alleged that the complainants resided at Danbury, Conn., and were "located and doing business as manufacturers and sellers of hats there." It was held, without dissent, that a combination to boycott the goods of the Danbury manufacturers, and prevent their sale in states other than Connecticut, was in restraint of interstate trade.

Of course, the facts differ materially, but the decision of the later case renders untenable the broad construction of the *Knight Case* contended for by the defendants, viz., that in no instance where a manufacturing corporation is concerned can relief be granted for the reason that interstate commerce though indirectly affected, is not sufficiently involved to justify proceedings under the act.

Since the *Knight Case* the tendency has been constantly towards a wider scope for the statute and I cannot believe that it is so impotent that it can be evaded, by the mere manipulation of a bill of lading—enforceable when a combination of manufacturers transports its products to other states and sells them there and utterly ineffectual if the precaution be taken to see that the title passes to the purchaser at the place of manufacture.

But even if it be conceded that the doctrine of the *Knight Case*, strictly construed, was applicable to some of the absorbed corporations and copartnerships, it certainly was not applicable to all, as some of them were unquestionably engaged in importing and selling their products by means of international and interstate commerce and there can be little doubt that the combination considered as a unit is so engaged. When merchandise is shipped from one state to another it seems obvious that the consignor or consignee is engaged in interstate commerce, or that both are so engaged. It cannot be that none of the parties, who set the wheels of transportation in motion on land and sea, is engaged in commerce and that Congress intended that the act should apply solely to common carriers. And yet, if no one can engage in trade or commerce between the states unless the actual physical transportation of the merchandise is done by him, it is obvious that the act can have no broader interpretation.

The law should not be defeated by a mere fiction. When a large number of independent corporations, firms and individuals are engaged in purchasing and manufacturing tobacco in several states and selling it in every part of the United States and in foreign countries, it seems clear that this is done through the instrumentality of interstate and foreign commerce. Without such commerce the business could not be conducted for a moment, the raw material would be left to rot in the warehouse, the manufactured product in the factory. The free interchange of these commodities, wherever they may be needed for barter or sale, is the life of the enterprise. Trade is the business of exchanging commodities by buying and selling for money. Interstate trade is the business of buying, selling and exchanging commodities between the states, and parties may be so engaged even though they act through

the agency of carriers. If then, the business of the independents above referred to be destroyed, interstate trade and commerce is destroyed to that extent, if the business of one or more of them be destroyed, interstate trade and commerce is destroyed *pro tanto*; in other words, there is less interchange of tobacco and its products between the states.

If I am right in thinking that many of the constituent companies were engaged in interstate commerce and that the breaking up of their business would inevitably affect the commerce of the country, it follows that their consolidation must produce a like result. The combination which has thus checked and hindered commerce and restrained its free circulation, has been guilty of a "restraint of trade or commerce among the several states," within the meaning of the act as interpreted by the Supreme Court. For these reasons I think an injunction should issue.

I am of the opinion, however, that it should not issue against the United Cigar Stores Company and should not issue, at least for the present, against R. P. Richardson, Jr., Company. In May, 1901, George J. Whelan and associates organized the United Cigar Stores Company for the purpose of retailing cigars and tobacco. This was done without the knowledge of the American Tobacco Company which refused to assist the enterprise in any way until its success as a selling agent was clearly demonstrated and established. It was at the suggestion of Whelan, not of the Tobacco Company, that its money was invested in the enterprise. Thereupon the Tobacco Company acquired a controlling interest in the Stores Company which has been held continuously and has been increased from time to time. Whelan and his associates have the active management of the Stores Company which deals in the products of the defendants and also of independent manufacturers. No member of the Tobacco Company or of its subsidiary companies is a member of the board of the Cigar Stores Company, and the evidence falls far short of establishing the proposition that the stores are managed in the interest of the Tobacco Company to the exclusion of other manufacturers. On the contrary, the weight of testimony is to the effect that the aim and purpose of the stores is to furnish anything that a user of tobacco may desire no matter by whom made. The company operates about 400 stores scattered throughout the United States but when it is realized that there are in this country over 600,000 places where tobacco is sold the impossibility of monopolizing the retail trade by one who operates only six-tenths of 1 per cent. of these places will at once be apparent. It cannot be assumed that a company which sells the products of all alike intends to secure a monopoly for one. Neither is the fact that the business is conducted in a large number of stores important.

The statute was not intended to strike down enterprise or to prevent the restraint of trade by destroying it. Many large merchants find it profitable to conduct their business through a chain of stores and it has never been held that the mere fact that a business is large and is extended over a wide territory renders its promoters amenable to the statute. Success is not a crime. Eliminating the fact that the Tobacco Company has a large pecuniary interest in the Stores Com-

pany, there is absolutely nothing left upon which to base the charge of a conspiracy to restrain and monopolize trade.

I cannot believe that the fact that a corporation, assuming it to have combined with others to restrain trade, invests its money in the business of another corporation engaged in selling its goods and those of others fairly to the public is of itself sufficient to convict the latter corporation of entering into a conspiracy to monopolize interstate commerce. If the business of the United Stores Company was and is legitimate, it cannot be condemned simply because the Tobacco Company has, in other respects, been guilty of unlawful conduct. The Cigar Stores Company and the Tobacco Company were not and could not be competitors; the former manufactures and sells tobacco by the wholesale, the latter sells whatever its customers want, no matter by whom manufactured, at retail only. It is true that the Cigar Stores Company has been energetically and, perhaps, aggressively managed; it is true that a part of the business thus built up would have been done by others had the company not been formed; but this is true of every large and successful business. Prosperity is the premium which has always been awarded to earnest and intelligent endeavor. The statute was never intended to punish success or reward incompetency. The proof fails to establish unfair or unlawful methods in acquiring and conducting the business of the Cigar Stores.

There were a few instances in which a business was purchased and, as the vendor was to continue in charge, a covenant was taken binding him not to engage in business in that locality on his own behalf. Such transactions are not forbidden. In the Joint Traffic Case, 171 U. S. 505, 19 Sup. Ct. 25, 43 L. Ed. 259, the court says, at page 567 of 171 U. S., at page 31 of 19 Sup. Ct. (43 L. Ed. 259):

"It might also be difficult to show that the appointment by two or more producers of the same person to sell their goods on commission was a matter in any degree in restraint of trade. We are not aware that it has ever been claimed that a lease or purchase by a farmer, manufacturer or merchant of an additional farm, manufactory or shop or the withdrawal from business of any farmer, merchant or manufacturer, restrained commerce or trade within any legal definition of that term; and the sale of a good will of a business with an accompanying agreement not to engage in a similar business was instanced in the *Trans-Missouri Case*, 166 U. S. 290, 17 Sup. Ct. 540, 41 L. Ed. 1007, as a contract not within the meaning of the act; and it was said that such a contract was collateral to the main contract of sale and was entered into for the purpose of enhancing the price at which the vendor sells his business."

No special privileges are accorded by the Tobacco Company to the Cigar Stores Company over other purchasers. Its business is conducted in its own way, without dictation from the Tobacco Company. I do not overlook certain sporadic instances of fault finding and attempted interference in the business by certain officers of the Tobacco Company but these attempts were negligible and should not be considered in determining the general character of the business. Generally speaking the relations existing between the two were those of a manufacturer and a retail customer, to whom the manufacturer sells direct. In short, the only circumstances which distinguish the Stores Company from other large dealers in the Tobacco Company's products

is that a majority of its stock is owned by the latter, and, as we have seen, this is insufficient to convict it under the law.

No injunction should issue against the R. P. Richardson, Jr., Company, at least for the present, for the following reasons: Very soon after a controlling interest in the Richardson Company had been purchased by the Tobacco Company disputes arose as to the terms and conditions of the agreement, which resulted in a suit being commenced by the Richardson Company in the courts of North Carolina for the purpose of having the contracts and agreements between the companies set aside and the status existing prior to the negotiations restored. This was followed shortly afterwards by a suit by the Tobacco Company in the courts of New Jersey to compel the Richardson Company to transfer a controlling interest in its stock to the Tobacco Company. Both of these actions are pending and undetermined, the prosecution of the North Carolina action having been enjoined by the New Jersey court. It is manifest that the trial of these actions, or one of them, may dispose of the issues now pending and that if the Richardson Company succeeds in establishing the fraud and misrepresentation alleged, relief may be granted which this court has not jurisdiction to grant. The issuing of the injunction should, therefore, be suspended until the hearing and determination of the actions in the state courts.

In view of the importance of the questions involved and the certainty that the case will be carried to the Supreme Court I think the injunction should not issue pending the hearing and decision in that court.

NOYES, Circuit Judge (concurring). The modern tendency of business is toward co-operation, instead of competition. This tendency, while of earlier inception, has developed with phenomenal activity in this country during the past 20 years—especially during the past decade. Concentration of interests and unification of control have taken the place of separate and independent operation. Important industrial corporations, formerly competing, have been combined into greater companies of wider scope, and these, in turn, have been united into combinations with vast resources, embracing, as their fields of operation, whole branches of industry.

And yet this economic development toward the elimination of competition has taken place in the face of statutes and judicial decisions declaring that "competition is the life of trade" and must be preserved. Combinations to prevent competition have always been declared contrary to public policy by the courts, and Congress, in the anti-trust statute of 1890, shortly after the inception of this economic movement and in view of the "trusts" of the period, went further than the common law and made those combinations which before had only been negatively unlawful positively criminal.

In so far as combinations result from the operation of economic principles, it may be doubtful whether they should be stayed at all by legislation. It may be that the evils in the existing situation should be left to the remedies afforded by the laws of trade. On the other hand,

it may be that the protection of the public from the operations of combinations of capital—especially those possessing the element of oppression—requires some measure of governmental intervention. It may be that the present anti-trust statute should be amended and made applicable only to those combinations which unreasonably restrain trade—that it should draw a line between those combinations which work for good and those which work for evil. But these are all legislative, and not judicial, questions. It cannot be too clearly borne in mind that this court has nothing to do with the wisdom, justice, or expediency of the statute. Equally true is it that this court, in applying the statute, must follow the decisions of the Supreme Court. If the decisions of that court have been too broad, it is for that court alone to modify them. The only right and duty of this court is to take the statute as it finds it, and, as it finds it, apply it in accordance with the interpretation placed upon it by the highest judicial tribunal. That this course may lead to results believed by many persons to be prejudicial to the public welfare cannot affect our action. This court can neither refuse to enforce a constitutional act of Congress nor ignore the decisions of the Supreme Court of the United States.

In approaching the consideration of the legal questions involved in this case, the inquiry of primary importance is met at the threshold: Are the defendants so engaged in interstate commerce that they are amenable to federal laws? Only in case they are so engaged is the consideration of other questions necessary. The examination of this fundamental question may well proceed upon the theory that the allegations of the petition are true—that the defendants have combined, and by combining have obtained practical control of the tobacco industry of the country. However comprehensive or oppressive the combination may be, unless it affect interstate commerce, it is not subject to the federal anti-trust statute.

There are many definitions of interstate commerce. This from *Gloucester Ferry Co. v. Pennsylvania*, 114 U. S. 196, 203, 5 Sup. Ct. 826, 828, 29 L. Ed. 158, has been repeatedly approved:

“Commerce among the states consists of intercourse and traffic between their citizens, and includes the transportation of persons and property, and the navigation of public waters for that purpose, as well as the purchase, sale, and exchange of commodities.”

The inquiry, then, is whether the record here shows “traffic” between citizens of different states, or the “purchase, sale, and exchange of commodities” across state lines.

The testimony discloses that the business of the defendants has three broad phases: (1) The purchase of the raw materials and supplies. (2) The manufacture of the product. (3) The disposition of the product. While the second phase—that of manufacture—does not involve interstate commerce, the other two phases seem clearly to directly involve it; and it also seems clear that the three phases are of equal importance. Unlike a mere manufacturing combination, this combination relates quite as much to the purchase of materials and the disposition of the product as to manufacture.

Leaf tobacco is purchased by the defendants' agents in tobacco mar-

kets, or directly from the grower in many different states, and is shipped by means of common carriers to factories or warehouses in other states. Licorice root for making licorice paste—necessary in producing certain kinds of tobacco—is purchased by a subsidiary corporation in foreign countries and is shipped to factories in this country. The paste, when manufactured, is sold to other of the defendants and is shipped to factories in different states. A subsidiary corporation manufactures tin foil and sells and ships it to the different factories. Another does the same thing with boxes, and another with cotton bags. Still another acts strictly as a purchasing corporation, and buys supplies in many markets, and sells and delivers them to the factories, warehouses, and offices throughout the country. The record shows constant intercommunication between the members of the combination in different states and constant shipments across state lines from one member to another as vendor and vendee.

The tobacco products manufactured by the defendants are largely sold by traveling salesmen, who solicit orders which, in most instances, are filled by shipping the goods ordered, by means of common carriers, from factories or warehouses located in states other than those in which the orders are taken. A limited number of jobbers in different states are also controlled, as well as an important retailer operating in different states. The business of the defendants covers the whole of the United States and the disposition of their products is effected under the supervision of an office of central authority by constant interstate shipments of the different commodities from factory, warehouse, or branch, to jobber, retailer, or consumer.

These facts seem clearly to show traffic between citizens of different states, and the purchase, sale, and exchange of commodities across state lines—to show that the defendants are directly engaged in commerce among the states and are subject to the federal anti-trust statute; and, as a practical matter, it is probable that a large part of the interstate shipments of the country are made by industrial combinations similar to that of the defendants. "Transactions between manufacturing companies in one state, through agents, with citizens of another, constitute a large part of interstate commerce." *Caldwell v. North Carolina*, 187 U. S. 622, 632, 23 Sup. Ct. 229, 233 (47 L. Ed. 336). If these corporations are not so engaged in interstate commerce as to be subject to federal regulation, then Congress, under the commerce clause, has little power except over carriers.

A point is made that this combination did not engage in interstate commerce in respect of sales made by traveling salesmen, because the title to the goods sold passed to the consignee when delivery was made to the common carrier in the place of manufacture. But the defendants engaged in interstate commerce when they sent their salesmen into different states and accepted and filled the orders obtained. "The negotiation of sales of goods which are in another state, for the purpose of introducing them into the state in which the negotiation is made, is interstate commerce." *Robbins v. Shelby Taxing District*, 120 U. S. 489, 497, 7 Sup. Ct. 592, 596, 30 L. Ed. 694. The sale of goods, by sample or otherwise, in one state by a traveling salesman em-

ployed by a manufacturer located in another state, and their subsequent shipment from the latter to the former state, constitute commerce among the states, with which Congress alone has power to deal. The Supreme Court of the United States has repeatedly held that state laws taxing or imposing conditions upon such sales are unconstitutional, as trenching upon the powers of Congress. Thus the court, in *Robbins v. Shelby Taxing District*, supra, said:

"If the selling of goods by sample and the employment of drummers for that purpose injuriously affect the local interest of the state, Congress, if applied to, will undoubtedly make such reasonable regulations as the case may demand. And Congress alone can do it; for it is obvious that such regulations should be based on a uniform system applicable to the whole country, and not left to the varied, discordant, or retaliatory enactments of 40 different states. The confusion into which the commerce of the country would be thrown by being subject to state legislation on this subject would be but a repetition of the disorder which prevailed under the Articles of Confederation."

See, also, *Brennan v. Titusville*, 153 U. S. 289, 14 Sup. Ct. 829, 38 L. Ed. 719; *Asher v. Texas*, 128 U. S. 129, 9 Sup. Ct. 1, 32 L. Ed. 368; *Caldwell v. North Carolina*, 187 U. S. 622, 23 Sup. Ct. 229, 47 L. Ed. 336; *Rearick v. Pennsylvania*, 203 U. S. 507, 27 Sup. Ct. 159, 51 L. Ed. 295.

Where the title to the goods sold by the salesman technically passes cannot, therefore, be regarded as important, "commerce among the states is a practical conception, not drawn from the 'witty diversities' (Yelv. 33) of the law of sales" (*Rearick v. Pennsylvania*, supra). Moreover, the facts bring the case within the language of *Swift v. United States*, 196 U. S. 375, 399, 25 Sup. Ct. 276, 280, 49 L. Ed. 518:

"But the allegations of the second section, even if they import a technical passing of title at the slaughtering places, also import that the sales are to persons in other states, and that the shipments to other states are part of the transaction—'pursuant to such sales'—and the third section imports that the same things which are sent to agents are sold by them, and sufficiently indicates that some at least of the sales are of the original packages. Moreover, the sales are by persons in one state to persons in another."

But still, if the technicality is important, the record shows, as we have seen, continued shipments of raw materials and finished products across state lines from one constituent corporation to another—constant purchases of materials, supplies, and products. If the combination as a shipper is not directly engaged in interstate commerce, then as a consignee it is so engaged, and the same result is reached.

Assuming, however, that these defendants are not directly engaged in interstate commerce, and are thus beyond the reach of the federal statute, what is the situation? Simply this: That there is no power—state or national—of practical efficiency which can reach industrial combinations, no matter how oppressive they may be. The result necessarily follows from the operation of the commerce clause of the Constitution. As we have just seen, the Supreme Court has held that state laws imposing conditions upon the sale of goods to be shipped into a state by a foreign vendor are unconstitutional, as trenching upon the powers of Congress. If such a sale is interstate commerce to the extent that it is free from local regulation, and yet the combination mak

ing it is not so directly engaged in interstate commerce as to be subject to federal control, then there is a hiatus in power which leaves the combination above the law.

The business of a producing combination, in so far as it affects states other than those in which its plants are located, consists in the sale and delivery of its products. If it may sell its goods by shipment across state lines free from local laws, it may freely do business in states with whose laws and policy it is wholly antagonistic. The police power could not be extended to reach it. Inspection laws and statutes regulating the sale of injurious articles would be ineffective. Such a combination might locate its factory over the boundary line of a state, and, operating from there, adopt the most oppressive tactics to stifle local competition. If the commerce clause ties the hands of the states, and yet fails to give Congress efficient power, its effect is to force upon the whole country the standard of the state which charters the combination or of that in which its plants are located—standards which, as limiting the power of the combination, might impose no limitation at all.

I cannot accept this conclusion. In my opinion that which the Constitution took from the states it gave to the nation. There was no loss of power in the transmission. There is no middle ground. The business of the defendants in selling their goods and buying their materials, involving interstate dealings not subject to state anti-trust statutes, is interstate commerce, subject to the federal anti-trust statute.

But it is contended that the question whether the defendants are directly engaged in interstate commerce is settled by the decision of the Supreme Court in *United States v. E. C. Knight Company*, 156 U. S. 1, 15 Sup. Ct. 249, 39 L. Ed. 325. I do not so regard the effect of that decision. As I view it, the opinion of the majority of the court turned upon the distinction between manufacture and commerce, and treated the case as one relating solely to manufacture within a single state. As said by the court (page 17 of 156 U. S., page 255 of 15 Sup. Ct. [39 L. Ed. 325]):

“What the law struck at was combinations, contracts, and conspiracies to monopolize trade and commerce among the several states or with foreign nations; but the contracts and acts of the defendants related exclusively to the acquisition of the Philadelphia refineries and the business of sugar refining in Pennsylvania, and bore no direct relation to commerce between the states or with foreign nations. The object was manifestly private gain in the manufacture of the commodity, but not through the control of interstate or foreign commerce.”

The object of the proceedings in that case was, not to reach the American Sugar Refining Company as an unlawful combination, but to prevent the acquisition by it of local manufacturing properties. It is true that it appeared, incidentally, that the article manufactured was intended for transportation beyond the state; but no combination relating either to the purchase and interstate shipment of raw materials or to the disposition of the finished product was shown. Upon the facts shown in this record the principles of the *Addyston Pipe Case* (175 U. S. 211, 20 Sup. Ct. 96, 44 L. Ed. 136) rather than those of the *Knight Case*, seem applicable.

These defendants are not a combination relating solely to manufacture, nor solely of manufacturers. As already shown, the combination embraces dealers as well as manufacturers, and producers of materials and supplies as well as of the finished tobacco products. The language of the Supreme Court in *Montague & Co. v. Lowry*, 193 U. S. 38, 47, 24 Sup. Ct. 307, 310, 48 L. Ed. 608, distinguishing the Knight Case, is applicable:

"It was not a combination or monopoly among manufacturers simply, but one between them and dealers in the manufactured article, which was an article of commerce between the states. *United States v. E. C. Knight Company*, 156 U. S. 1, 15 Sup. Ct. 249, 39 L. Ed. 325, did not, therefore cover it."

Furthermore, the recent decisions of the Supreme Court indicate that the Knight decision is inapplicable to a case like the present. Thus, in the *Northern Securities Case*, 193 U. S. 197, 329, 24 Sup. Ct. 436, 453, 48 L. Ed. 679, Mr. Justice Harlan said of the Knight decision:

"It was held that the agreement or arrangement there involved had reference only to the manufacture or production of sugar by those engaged in the alleged combination; but, if it had directly embraced interstate or international commerce, it would then have been covered by the anti-trust act and would have been illegal."

And in *Swift v. United States*, 196 U. S. 375, 397, 25 Sup. Ct. 276, 279, 49 L. Ed. 518, the court said:

"Although the combination alleged embraces restraint and monopoly of trade within a single state, its effect upon commerce among the states is not accidental, secondary, remote, or merely probable. On the allegations of the bill the latter commerce no less, perhaps even more, than commerce within a single state, is an object of attack. * * * Moreover, it is a direct object. It is that for the sake of which the several specific acts and courses of conduct are done and adopted. Therefore the case is not like *United States v. E. C. Knight Co.*, 156 U. S. 1, 15 Sup. Ct. 249, 39 L. Ed. 325, where the subject-matter of the combination was manufacture and the direct object monopoly of manufacture within a state."

See, also, *Loewe v. Lawlor*, 208 U. S. 274, 28 Sup. Ct. 301, 52 L. Ed. 488.

In view of the world-wide business of these defendants, of the constant reaching out for new markets in new countries, of the many different industries in many different states involved, of the constant shipments of materials from state to state, and of the control of the disposition of the manufactured product, can it be said that the direct object of this vast combination—the dominating factor in the tobacco industry of the country—is the "monopoly of manufacture within a state"? I must answer this question in the negative. In my opinion the defendants are engaged in interstate commerce, and that which the combination directly affects is interstate commerce.

This conclusion ends the inquiry of the greatest moment in the case. It is of much importance to many people at the present time whether the defendants have entered into an unlawful combination. It is of the most momentous importance to all the people for all time whether the national government has power to reach industrial combinations dealing across state lines. Concede that the present statute goes too far. Concede, even, that no enactments are now necessary. Yet all must

agree that conditions may arise in the future requiring legislative action which shall be both uniform and effective. Congress alone could take such action, and if this case shall finally establish that the power exists in Congress to take it, then, regardless of all other results, it is a good thing for the future of this country that these proceedings were instituted.

Returning, now, to the charges against these defendants, and regarding it as settled that, if a combination or monopoly within the meaning of the anti-trust statute is shown, it directly affects interstate commerce, the next inquiry is whether such a combination or monopoly is established. In determining whether a combination, within the meaning of the statute, is shown, these propositions must be accepted as established by decisions of the Supreme Court of the United States:

(1) Every combination in restraint of interstate commerce, whether reasonable or unreasonable, is in violation of the statute. The present state of the law is thus summarized in the very recent case of *Shawnee Compress Co. v. Anderson*, 209 U. S. 423, 434, 28 Sup. Ct. 572, 575, 52 L. Ed. 865:

"And it has been decided that not only unreasonable, but all direct, restraint of trade are prohibited, the law being thereby distinguished from the common law."

See, also, *United States v. Trans-Missouri Freight Ass'n*, 166 U. S. 290, 17 Sup. Ct. 540, 41 L. Ed. 1007; *Northern Securities Case*, 193 U. S. 197, 24 Sup. Ct. 436, 48 L. Ed. 679.

(2) Every combination restraining competition in interstate trade is a combination in restraint of interstate commerce. As said by Mr. Justice Harlan in the *Northern Securities Case*, 193 U. S. 197, 337, 24 Sup. Ct. 436, 457, 48 L. Ed. 679:

"To destroy or restrict free competition in interstate commerce was to restrain such commerce."

And as stated by the court in *National Cotton Oil Co. v. Texas*, 197 U. S. 115, 129, 25 Sup. Ct. 379, 382, 49 L. Ed. 689, in speaking of the purpose of the state and federal statutes against combination:

"According to them, competition, not combination, should be the law of trade. If there is evil in this, it should be accepted as less than that which may result from the unification of interests, and the power such unification gives."

This construction of the statute confines the duty of this court in applying it within very narrow limits. We have only to inquire whether the evidence shows a combination restraining competition. There is no necessity for going further. Other inquiries are immaterial. The combination may not reduce the prices paid to the growers of raw materials, may not increase the prices charged to consumers, may not seek to exclude all others from the field, may be free from coercion or oppression, and yet if it restrict competition, if it restrain trade, reasonably or unreasonably, it falls within the statute. The statute declares unlawful every combination in restraint of trade. It contains no words of limitation or qualification, and the Supreme Court of the

United States has decided that the courts have no right to attach them to it.

In looking through the record for a combination which restricts competition, it is not necessary to go far. The defendants, in their own statement of that which they have done, present such a combination. In their brief (page 132) they say that their actions fall into two classes, of which the following is the first:

"The consolidation of interests, more or less sharply competitive, through the formation of a corporation and the transfer to it of the respective properties and business of such competitors."

A consolidation of competitive interests in this form, when a combination, as distinguished from a sale, is a combination which, restraining interstate commerce, violates the federal anti-trust statute. Whether a transaction amounts to a sale or to a combination depends upon whether the vendor parts with all interests in the business sold or merely changes the form of his investment. A bona fide sale of a plant for cash or its equivalent possesses none of the elements of a combination. An exchange of one plant for an interest in united plants possesses all the elements of combination. See *Davis v. A. Booth & Co.*, 131 Fed. 37, 65 C. C. A. 269; *Bigelow v. Calumet, etc., Mining Co. (C. C.)* 155 Fed. 869; also, upon the underlying principle involved, *Shawnee Compress Co. v. Anderson*, 209 U. S. 423, 28 Sup. Ct. 572, 52 L. Ed. 865, and the Northern Securities Case, *supra*.

The testimony in this case shows repeated instances where, upon the transfer of a competing business, the vendors merely changed the form of their investment. They transferred their property and received in exchange stock in the transferee corporation. They exchanged large interests in a small property for small interests in a large property. Instead of standing by themselves, they combined, and, in combining, violated the federal statute.

There is no especial merit in the corporate form of combination. A corporation without statutory authority—express or incidental—to acquire property cannot take it at all. With such authority it has only the power which an individual enjoys of natural right. Both may purchase and otherwise acquire property for lawful purposes; but neither can acquire property for a purpose forbidden by law. The corporations formed by the defendants, with the ordinary power to acquire all kinds of property, had no right to acquire property in order to form an unlawful combination. The grant of power would not be construed as authorizing any such acquisition; and any grant which went further, and did attempt to authorize the formation of a combination in violation of the federal statute, would be wholly void. No state can authorize any individual or corporation to break a law of the United States. See the Northern Securities Case, *supra*. Upon the defendants' own presentation of their acts, therefore, I cannot avoid the conclusion that they have, with certain exceptions, engaged in a combination contrary to the first section of the federal anti-trust statute.

In thus considering whether the defendants have combined in violation of the first section of the act, they have been treated as an asso-

ciation of corporations and individuals. But they are all dominated by the American Tobacco Company, and, in determining whether a monopoly has been created in contravention of the second section, they may properly be considered as a unit. In pursuing the latter inquiry, however, it is not necessary to go far. The violation of the first section requires the issuance of an injunction. No further relief could be granted, should the defendants be held to also violate the second section. The question of monopoly is, however, fully presented upon the briefs, and I think should not be passed over.

It appears from the record that the defendants produce 70 per cent. of the smoking tobacco made in this country, 73 per cent. of the cigarettes, 81 per cent. of the plug and twist tobacco, 81 per cent. of the fine-cut tobacco, 89 per cent. of the little cigars, and 96 per cent. of the snuff. They also make 95 per cent. of the licorice paste produced, 75 per cent. of the tin foil, and most of the tobacco extracts, boxes, and containers.

The acquisition by the defendants in taking over the various competing plants of most of the well-established and popular brands of tobacco gives them especial power to control the market. As pointed out in the defendants' brief:

"The difficulties of establishing a brand of tobacco are numerous, but they are compensated by the value of the brand when established."

The consumer becomes accustomed to, and buys by, a brand. It is difficult to induce him to purchase another brand. "His habit is a 'Bull Durham' habit, and not a mere tobacco habit."

The defendants purchase the major part of all the tobacco leaf—other than that used for cigars—raised in this country. Of some important types they buy a very large proportion of the total production. Thus of burley, used in the manufacture of plug tobacco, they bought in 1905 175,000,000 pounds out of a total crop of 240,000,000 pounds; of Virginia sun cured, used for chewing tobacco, they bought 7,400,000 pounds out of a crop of 8,100,000 pounds. The hold of the defendants upon the tobacco industry of the country has steadily increased since the formation of the combination. There is only one branch of the industry which they do not have within their grasp—the cigar branch; but their predominating interest in all of the other branches is not lessened by the fact that they have not as yet obtained control of this branch. To create a monopoly, it is not necessary to gather in all the branches of a great industry.

In view of these facts, and of the further fact that the assets of the defendants amount to hundreds of millions of dollars, let us, with respect to the question whether they are monopolizing trade, again test their position from their own point of view. In examining the second section of the act the defendants in their brief (page 172) say:

"The sole question is: Do the defendants so engross the market that they can prevent others from engaging therein freely, and thus at pleasure fix the prices either of the raw materials or of the manufactured article?"

The record shows that, to establish and popularize a brand of tobacco, the expenditure of much time and money is necessary. Whether a person of moderate capital could successfully engage in the

manufacture of tobacco would depend entirely upon the position taken by the defendants. They might suffer him to succeed. On the other hand, they might deem it expedient to crush him, and, if they exercised the power which they possess, there could be but one result. Considering the enormous inherent and collateral power of the defendants, the record is remarkably free from acts of oppression or coercion. But still there is enough to show how a competitor can be brought to terms if occasion demands. The letters between the defendants' officials point out most effective means for entering "upon a vigorous campaign, to be kept up until the desired end is accomplished."

Under these conditions, I am of the opinion—in answer to the first phase of the defendants' question—that the defendants do so engross the tobacco market that they have power "to prevent others from engaging therein freely." The extent to which they have exercised their power is immaterial. The question presented by the defendants' inquiry is one of the existence of power, not its exercise.

Subject to the economic limit that prices cannot be fixed so low as to deprive the grower of inducement to raise future crops, the extent of the defendants' purchases of tobacco leaf necessarily gives them large power to fix the prices to be paid for the types which they require. Prices may be regulated—as the defendants assert—by the law of supply and demand; but the difficulty here is that the demand for many types comes, practically, from only one source. To whom, for example, can the growers of burley or Virginia sun-cured tobacco sell their crop, if they refuse the prices offered by the defendants? Similarly, the production by the defendants of by far the greater part of the tobacco used in this country gives the power to control the prices of the manufactured article, subject to the economic limit that, if placed too high, the consumer will give up the use of tobacco. It is not a question of going to another producer. No other producer could supply the amount required. Where will the users of snuff obtain it, if they are unwilling to pay the prices charged by the defendants?

Moreover, the defendants possess an even greater power over the prices of raw materials and finished products than the statistics which we have noticed indicate. It is apparent from the record that they are the dominating factors in the tobacco industry. Other producers are scattered and do not act together. They are not in a position to initiate price making.

They must follow the action of the defendants. Upon these facts, I am of the opinion that the second phase of the defendants' inquiry must, like the first, be answered in the affirmative—that the defendants do have power to determine the prices of raw materials and of the manufactured article.

Thus, applying to the defendants' position the test of their own inquiry, it follows that they constitute a monopoly. And the same result is reached if it be sought to bring them within the description of a monopoly stated by Mr. Justice McKenna in *National Cotton Oil Co. v. Texas*, 197 U. S. 129, 25 Sup. Ct. 382, 49 L. Ed. 689:

"Its dominant thought now is, to quote another, 'the motion of exclusiveness or unity'; in other words, the suppression of competition by the unifica-

tion of interest or management, or, it may be, through agreement and concert of action. And the purpose is so definitely the control of prices that monopoly has been defined to be 'unified tactics with regard to prices.' It is the power to control prices which makes the inducement of combinations and their profit. It is such power that makes it the concern of the law to prohibit or limit them."

Still another test brings us to the same conclusion. The authorities warrant the statement that a monopoly, in the modern sense, is created when, as a result of efforts to that end, previously competing businesses are so concentrated in the hands of a single person or corporation, or a few persons or corporations acting together, that they have power to practically control the prices of commodities and thus to practically suppress competition. *National Cotton Oil Co. v. Texas*, supra; *United States v. E. C. Knight Co.*, 156 U. S. 1, 15 Sup. Ct. 249, 39 L. Ed. 325; *Northern Securities Case*, 193 U. S. 197, 24 Sup. Ct. 436, 48 L. Ed. 679; *Swift v. United States*, 196 U. S. 375, 25 Sup. Ct. 276, 49 L. Ed. 518; *American Biscuit, etc., Co. v. Klotz (C. C.)* 44 Fed. 724; *United States v. Chesapeake, etc., Fuel Co. (C. C.)* 105 Fed. 104; *Chesapeake & O. Fuel Co. v. United States*, 115 Fed. 610, 53 C. C. A. 256; *People v. North River Sugar Refining Co.*, 54 Hun, 377, note, 3 N. Y. Supp. 401, 2 L. R. A. 33; *Pocahontas Coke Co. v. Powhatan Coal, etc., Co.*, 60 W. Va. 508, 56 S. E. 264, 10 L. R. A. (N. S.) 268, 116 Am. St. Rep. 901; *Richardson v. Buhl*, 77 Mich. 658, 43 N. W. 1102, 6 L. R. A. 457; *Harding v. American Glucose Co.*, 182 Ill. 615, 55 N. E. 577, 64 L. R. A. 738, 74 Am. St. Rep. 189; *Herriman v. Menzies*, 115 Cal. 16, 44 Pac. 660, 46 Pac. 730, 35 L. R. A. 318, 56 Am. St. Rep. 81; *Lough v. Outenbridge*, 143 N. Y. 271, 38 N. E. 292, 25 L. R. A. 674, 42 Am. St. Rep. 712; *Wood v. Greenwood Hardware Co.*, 75 S. C. 383, 55 S. E. 973, 9 L. R. A. (N. S.) 501. And the examination of facts already made shows this concentration of power in the hands of the defendants.

It must be noted that the authorities hold that the material consideration, in determining whether a monopoly exists, is not that prices are raised and that competition is excluded, but that power exists to raise prices or to exclude competition when it is desired to do so. The validity of an organization, according to the authorities—

"is not to be tested by what has been done under it, but by what may be done under it; not by its performance, but by its power of performance when fully exercised." *Pocahontas Coke Co. v. Powhatan Coal, etc., Co.*, supra.

Following the authorities, the necessary result is that the defendants, in possessing the power of control over the tobacco market, monopolize interstate trade and commerce within the meaning and in violation of the second section of the statute. And yet, in view of the possible results from this interpretation of the statute, I could only with hesitation unqualifiedly adopt it. An aggregation of capital or property, with power to control the market for a product, might be brought about by lawful means without the element of combination, and might carry on its operations without the element of oppression. If the mere possession of power is the test of legality, then the inquiry in that case, as in any other case, would merely relate to the present status of the aggregation: What has it power to do?—with-

out regard to its past history or its present methods. Thus a result might be declared unlawful, which was obtained by lawful means; an aggregation of capital criminal, which actually operated to the public benefit. The law that illegality depends wholly upon the power of performance may be settled; but it was not settled when the tendency towards the unification of interests was so marked as at the present time. It may be that now, in applying the second section of the statute, performance, as well as power of performance, should be considered; that the elements of oppression and coercion should be shown to exist, to establish an unlawful monopoly. And, if these elements are to be considered, they are not sufficiently presented upon this record. It is not shown that the defendants have reduced prices to growers, nor that they have raised prices to consumers. The instances of coercion which are shown appear rather as incidental to the development of a great business than as indicative of a policy of oppression. But a judicial opinion upon the important question whether the conclusion which the authorities lead to should be adopted without qualification in construing and applying the second section should only be expressed when necessary to the rendition of a decision. There is no such necessity in this case. In view of the opinions of the other members of the court, the decree must run against the defendants under the first, and not under the second, section of the statute. Therefore, while I have felt it my duty to examine the situation under the second section, its consideration need not be carried further.

The only matters remaining relate to the decree. While not wholly adopting the views of Judges LACOMBE and COXE with respect to certain of the defendants, I concur in the results which they reach, and in their conclusion that an injunction of the nature stated should be issued against the defendants, with the exceptions noted, but with stay pending appeal.

WARD, Circuit Judge (dissenting). I feel constrained to dissent from the judgment of the court in this case. The United States charges in its bill that the defendants have been and are engaged in an illegal combination to restrain and monopolize trade, in violation of an act of Congress passed July 2, 1890 (26 Stat. 209, c. 647 [U. S. Comp. St. 1901, p. 3200]) known as the "Sherman Act," and prays for relief by injunction and otherwise. An outline of the acts complained of as evidencing a combination in restraint of trade and a monopoly is as follows:

In January, 1890, the American Tobacco Company was incorporated, to take over the business of five independent concerns engaged almost wholly in the manufacture of cigarettes. This company substantially covered the entire output of cigarettes in the United States. It is no defense that it was incorporated some six months before the passage of the Sherman act, if an illegal combination within the meaning of that act. *United States v. Trans-Missouri Freight Association*, 166 U. S. 290, 17 Sup. Ct. 540, 41 L. Ed. 1007. There is no evidence that the combination was the result of cutting of prices or of a commercial war of any kind. The company from time to time bought

other plants engaged in manufacturing smoking tobacco and others engaged in manufacturing plug tobacco.

In 1898 the Continental Tobacco Company was incorporated, to take over the plug tobacco business of the American Tobacco Company and the business of five other independent concerns manufacturing principally plug tobacco. There had been a war in the way of cutting of prices in certain brands of plug tobacco, which probably had something to do with the formation of it. Subsequently the American Tobacco Company bought or obtained control of many plants engaged in the manufacture of smoking tobacco, and the Continental many plants engaged in the manufacture of plug tobacco. Some of them were absorbed, and others, like the defendants, continued their corporate existence.

In 1900 the American Snuff Company was incorporated, to take over the snuff business of the American Tobacco Company, of the Continental Tobacco Company, and of two other independent manufacturers.

In 1901 the American Cigar Company was incorporated, to take over the business of the American Tobacco Company and of Powell, Smith & Co. in manufacturing and selling cigars, cheroots, and stogies. In the same year the Consolidated Tobacco Company was incorporated, to take over as a holding company, in exchange for its bonds, substantially all of the stock of the American Tobacco Company and the Continental Tobacco Company.

In 1903 the American Stogie Company was incorporated, to take over the stogie business of the American Cigar Company, the American Tobacco Company, and the Continental Tobacco Company. In 1904 the American Tobacco Company, the Continental Tobacco Company, and the Consolidated Tobacco Company were merged into the present American Tobacco Company.

The companies above named, being the principal defendants, acquired control of the plants of many other concerns engaged in manufacturing or distributing tobacco, and also of concerns supplying things necessary in the tobacco business, such as tin foil, licorice root, and its products, bags, boxes, signs, and briar pipes. Most of the vendors of the tobacco plants entered into contracts not to engage in the business sold in certain territory for a certain time, which I regard as proper for the protection of the vendees.

Referring to the combination of 1904, which created the present American Tobacco Company, it is to be remembered that the Consolidated Company was a mere holding company, and the American Tobacco Company and the Continental Tobacco Company were in no sense competitors; the former being engaged in manufacturing cigarettes and smoking tobacco, and the latter in manufacturing plug and twist tobacco. Their merger was not in restraint of trade, unless it could be regarded as an illegal monopoly, because it produced from 60 to 90 per cent. of the total output of the United States of the various articles it manufactured. The profits of the present American Tobacco Company and its controlled companies have been and are very large, and their business, excluding cigars, covers not less than

75 per cent. of the whole output of manufactured tobacco in the United States.

The government has offered in evidence a stipulation (Government's Exhibit No. 8) of all the defendants, except the Imperial Tobacco Company, the United Cigar Stores Company, R. L. Richardson Company, Incorporated, and W. C. Reed, which must be taken correctly to describe the way the business is done, there being nothing in the record to the contrary, as follows:

"We admit that all the vendors and corporation defendants mentioned in the petition as engaged in the manufacture and sale of tobacco products, except Imperial Tobacco Company, Limited, purchased or now purchases some or all of the requisite raw material in states or countries other than those in which the factories were or are located, and had or has it transported thence through the medium of common carriers to said factories, and employed or employ traveling salesmen, who solicited or solicit in states or countries other than those in which the factory was or is located orders for the tobacco products, which by them were or are transmitted to said factory or other chief office of the manufacturer, and, if approved, they are filled by the delivery of the goods to a common carrier where the factory was or is located, duly consigned to the purchaser; title passing to said purchaser on said delivery to the common carrier."

It can hardly be doubted that a manufacturer who makes his product of materials found within the state of manufacture and sells his entire product there is not engaged in interstate commerce. It will make no difference that the purchasers send and sell the manufacturer's product throughout the United States. Except that they buy their raw material in other states, this is the way the manufacturing defendants in this case do their business. Their business is manufacturing, and the fact that they get their raw material in other states and send agents to other states to solicit orders does not make their business interstate commerce. This certainly appears to be the view of the Supreme Court in the case of *United States v. E. C. Knight Co.*, 156 U. S. 1, 15 Sup. Ct. 249, 39 L. Ed. 325. In it the American Sugar Refining Company and four refineries in Philadelphia were all engaged in competition with each other in the importing of raw sugar into the United States, refining it, and selling it throughout the country. Their business was exactly like that of the principal defendants, except that it was in a necessary of life, instead of a luxury. A combination was made between the American Sugar Refining Company and the Pennsylvania refineries by the exchange of all their capital stock for shares of its capital stock. The monopoly was greater than in the case now under consideration, because the combination manufactured 98 per cent. of the entire sugar output of the United States. The bill averred that the American Sugar Refining Company monopolized the manufacture and sale of refined sugar in the United States, controlled its price, and had combined with the other defendants to restrain the commerce in refined sugar in the several states and foreign nations and to increase its price. The trial court (60 Fed. 306) found that:

"The object in purchasing the Philadelphia refineries was to obtain a greater influence or more perfect control over the business of refining and selling sugar in this country."

When the case reached the United States Supreme Court, Chief Justice Fuller, who delivered the opinion of the court, assumed that the transaction did constitute a monopoly, but held that it was a monopoly of the manufacture of a necessary of life. He said, at page 17 of 156 U. S., and page 255 of 15 Sup. Ct. (39 L. Ed. 325):

"The object was manifestly private gain in the manufacture of the commodity, but not through the control of interstate or foreign commerce. It is true that the bill alleged that the products of these refineries were sold and distributed among the several states, and that all the companies were engaged in trade or commerce with the several states and with foreign nations; but this was no more than to say that trade and commerce served manufacture to fulfill its function. Sugar was refined for sale, and sales were probably made at Philadelphia for consumption, and undoubtedly for resale by the first purchasers throughout Pennsylvania and other states, and refined sugar was also forwarded by the companies to other states for sale. Nevertheless it does not follow that an attempt to monopolize, or the actual monopoly of, the manufacture was an attempt, whether executory or consummated, to monopolize commerce, even though, in order to dispose of the product, the instrumentality of commerce was necessarily invoked. There was nothing in the proofs to indicate any intention to put a restraint upon trade or commerce; and the fact as we have seen that trade or commerce might be indirectly affected was not enough to entitle complainants to a decree. The subject-matter of the sale was shares of manufacturing stock, and the relief sought was the surrender of property which had already passed and the suppression of the alleged monopoly in manufacture by the restoration of the status quo before the transfers; yet the act of Congress only authorized the Circuit Courts to proceed by way of preventing and restraining violations of the act in respect of contracts, combinations, or conspiracies in restraint of interstate or international trade or commerce."

It is clear that the court recognized that the business of the defendants, though manufacturing, did incidentally, and not directly, embrace interstate commerce. If this fact sufficed to bring them within the Sherman act, then almost every occupation may be regulated by Congress. The dissenting opinion of Harlan, J., proceeded principally upon the theory that the combination was necessarily one relating to the sale of goods, and raised every objection now relied upon by the government to the conclusion of the court.

The majority of the court think that subsequent decisions, especially *Loewe v. Lawlor*, 208 U. S. 274, 28 Sup. Ct. 301, 52 L. Ed. 488, have impliedly overruled the *Knight Case*. In no subsequent decision has it been expressly qualified, and in the *Loewe Case* Chief Justice Fuller, delivering the unanimous opinion of the court, said at page 279 of 208 U. S., and page 304 of 28 Sup. Ct. (52 L. Ed. 488):

"We do not pause to comment on such cases as *United States v. Knight*, 156 U. S. 1, 15 Sup. Ct. 249, 39 L. Ed. 325; *Hopkins v. United States*, 171 U. S. 578, 19 Sup. Ct. 40, 43 L. Ed. 290; and *Anderson v. United States*, 171 U. S. 604, 19 Sup. Ct. 50, 43 L. Ed. 300, in which the undisputed facts showed that the purpose of the agreement was not to obstruct or restrain interstate-commerce. The object and intent of the combination determined its legality."

It has been suggested that the plaintiffs in the *Loewe Case* must have been held by the court to have been directly engaged in interstate commerce, or otherwise the demurrer would not have been overruled, and, if they were directly engaged in interstate commerce, the defendants in the *Knight Case* must have been so also; the only difference being that one manufactured sugar and the other manufactur-

ed hats. But one need not be engaged in interstate commerce at all to get the benefit of the Sherman act. Section 7 authorizes "any person who shall be injured in his business or property" by a violation of the act to bring just such a suit as Loewe brought. Although the plaintiffs, as manufacturers, might not have been engaged in business which would bring them within the operation of the Sherman act, still a combination of third parties to restrain a part of their business incidentally embraced in interstate commerce might well bring that combination within the operation of the act. The decision in the Loewe Case was unanimous, and, expressly approving the Knight Case, proceeded upon the ground that the defendants' combination necessarily and directly restrained the purchases and sales of hats between the plaintiffs and citizens of other states. Chief Justice Fuller delivered the opinion in both cases. Three of the justices who were of the majority in the Knight Case concurred in the Loewe Case, and it can hardly be supposed that they were overruling the Knight Case by implication.

I think it conclusive in this case. If it be said this conclusion would leave great evils without correction, the answer is they may be corrected by the states or in the territories by the United States, because they can prevent monopolies and combinations in restraint of trade within their own borders, whether carried on by their own citizens or by others.

Assuming, however, that the Knight Case does not apply, are the defendants within the prohibition of the first section of the Sherman act? Undoubtedly the original American Tobacco Company and the Continental Tobacco Company (both of which have ceased to exist) and the American Snuff Company and the American Cigar Company were combinations of independent concerns; but every combination is obviously not within the act. The prohibition is against combinations whose purpose is to restrain trade. Such a combination is within the act, even if it fail to do so; while one whose purpose is not to restrain trade is not within the act, even if it incidentally does so. Intention is of prime importance, because the acts prohibited are made crimes. So far as the volume of trade in tobacco is concerned, the proofs show that it has enormously increased from the raw material to the manufactured product since the combinations, and, so far as the price of the product is concerned, that it has not been increased to the consumer and has varied only as the price of the raw material of leaf tobacco has varied.

The purpose of the combinations was not to restrain trade or prevent competition, although competition was incidentally prevented, but, by intelligent economies, to increase the volume and the profits of the business in which the parties were engaged. No agreements were entered into, as in many of the decided cases, that operated directly on interstate commerce through common carriers by maintaining rates or preventing competition, like *United States v. Trans-Missouri Freight Association*, 166 U. S. 290, 17 Sup. Ct. 540, 41 L. Ed. 1007, *United States v. Joint Traffic Association*, 171 U. S. 505, 19 Sup. Ct. 25, 43 L. Ed. 259, and *Northern Securities Co. v. United States*, 193 U. S. 197, 24 Sup. Ct. 436, 48 L. Ed. 679, or which limited output of

manufacturers or regulated the prices at or the territory within which their output should be sold throughout the United States, as in *Addyston Pipe & Steel Co. v. United States*, 175 U. S. 211, 20 Sup. Ct. 96, 44 L. Ed. 136, *Montague & Co. v. Lowrey*, 193 U. S. 38, 24 Sup. Ct. 307, 48 L. Ed. 608, and *Swift & Co. v. United States*, 196 U. S. 375, 25 Sup. Ct. 276, 49 L. Ed. 518, or which sought to prevent any interstate commerce at all in the goods in question, as in *Loewe v. Lawlor*, 208 U. S. 274, 28 Sup. Ct. 301, 52 L. Ed. 488.

The case of *Shawnee Compress Co. v. Anderson*, 209 U. S. 423, 28 Sup. Ct. 572, 52 L. Ed. 865, on which the government relies, throws little light on the one under consideration. It was an appeal from the Supreme Court of the territory of Oklahoma, which court found as a fact that the lease in question was made in aid of a conspiracy to suppress competition and secure a monopoly. There is nothing to show whether the court was relying upon the common law, the trust act of the territory, or the Sherman act. The Supreme Court felt itself confined to determining whether there was evidence to support the conclusion of the territorial court, and, finding that there was, affirmed the decree, Mr. Justice McKenna said, referring to the trial court:

"The court further said that it found 'ample authority in the record for that action,' and, following the rule 'often reiterated,' the court further said 'it must hold that, where a record contains some evidence to support the finding of the trial court,' the judgment will not be disturbed. The ruling sustaining the power of the Shawnee Company to execute the lease is attacked by appellees, but we do not find it necessary to express an opinion upon it, on account of the view we entertain of the second proposition. In passing on the second proposition the Supreme Court decided adversely to the view taken by the trial court. The court, therefore, must either have conceded that there was not some evidence supporting the conclusions of fact of the trial court, or must have deemed the principles of law which the trial court upheld were not sustained by its conclusions of fact. As our view in the nature of things is confined to determining whether the court below erred, it follows that our reviewing power under the circumstances is coincident with the authority to review possessed by the court below, and therefore we are confined, as was the court below, to determining whether there was some evidence supporting the findings, and whether the facts found were adequate to sustain the legal conclusions. *Southern Lumber Co. v. Ward*, 208 U. S. 126, 28 Sup. Ct. 239, 52 L. Ed. 420."

It remains to inquire whether the American Tobacco Company and its controlled companies constitute a monopoly of or attempt to monopolize a part of the foreign commerce or commerce between the states under the second section of the Sherman act. As this section prohibits a monopoly of or an attempt to monopolize any part of such commerce, it cannot be literally construed. So applied, the act would prohibit commerce altogether. The first and second sections must be read together, and I think mean the same thing; the second adding nothing except to extend the prohibition to individuals who, without combination, monopolize or attempt to monopolize. It must be understood to prohibit monopolies or attempts to monopolize brought about by the unlawful means contemplated in the first section, viz., the purpose to restrain trade by preventing competition and preventing others from participating in it. The third section of the act bears out this

construction, because it does not mention monopolies or attempts to monopolize in the territories or District of Columbia, where the jurisdiction of the United States is supreme in all things, and it can hardly be that Congress intended to declare innocent acts committed within them which it pronounces crimes if committed in the states.

The purposes of the defendants should not be made to depend upon occasional illegal or oppressive acts or letters, but must be collected from their conduct as a whole. A perusal of the record satisfies me that their purposes and conduct were not illegal or oppressive, but that they strove, as every business man strives, to increase their business, and that their great success is a natural growth resulting from industry, intelligence, and economy, doubtless largely helped by the volume of business done and the great capital at command.

For these reasons, without considering others discussed by counsel, I think the bill should be dismissed. For final decree see 164 Fed. 1024.

KANSAS CITY v. METROPOLITAN WATER CO.

(Circuit Court, D. Kansas, First Division. October 10, 1908.)

1. REMOVAL OF CAUSES (§ 42*)—SUITS REMOVABLE—CONDEMNATION PROCEEDINGS.

A state is without power by the mere form of procedure prescribed to deprive the owner of property sought to be taken by condemnation proceedings from removing such proceedings into a federal court if such owner be a citizen of a foreign state and the value of the property exceeds the jurisdictional amount.

[Ed. Note.—For other cases, see Removal of Causes, Dec. Dig. § 42.*]

2. REMOVAL OF CAUSES (§ 79*)—CONDEMNATION PROCEEDINGS—TIME FOR REMOVAL.

Laws Kan. 1908, p. 30, c. 33, authorizes cities of the first class having a population of over 50,000 to condemn waterworks property. It provides that when authorized by a resolution of the mayor and city council the city may apply to the judge of the district court, who shall appoint commissioners to appraise the property and assess the damages; that an appeal may be taken from such award and tried in the district court, but that on the payment of the amount of the award to the county treasurer by the city it shall become the owner of the property with the right of possession. *Held*, that a proceeding by a city under such statute is a judicial proceeding from its inception, and that a defendant water company which is a citizen of another state may remove the same into a federal court at any time after the application for the appointment of commissioners, and is not compelled to wait until an award has been made and an appeal taken, when it has been deprived of its property and the only question to be litigated is the amount of compensation to which it is entitled.

[Ed. Note.—For other cases, see Removal of Causes, Dec. Dig. § 79.*]

Proceedings under power of eminent domain as civil suits under laws relating to removal of causes to federal courts, see note to South Dakota Ry. Co. v. Chicago, M. & St. P. Ry. Co., 73 C. C. A. 183.]

On Motion to Remand to State Court.

Miller, Buchan & Miller, Samuel Maher, and Willard P. Hall, for complainant.

H. L. Alden, City Counselor, for defendants.

*For other cases see same topic & § NUMBER in Dec. & Am. Digs. 1907 to date, & Rep'r Indexes

POLLOCK, District Judge. At the 1908 Special Session of the Legislature of this state (Laws 1908, p. 30, c. 33), there was enacted a law conferring upon cities of the first class the power of condemning and taking over the property, or any part thereof, of any water company located in any such city, which act, in so far as material to this inquiry, provides, as follows:

"Section 1. That any city of the first class having a population of over fifty thousand is hereby empowered to acquire by the exercise of the right of eminent domain the whole or any part of any water-supply plant, including all pipes, mains and other appurtenances and rights and property, real or personal, of every kind pertaining thereto, situated either within or without such city or partly within and partly without such city; and it is further empowered to acquire by the exercise of the power of eminent domain any other property owned by any person or corporation, real or personal, necessary to the construction, improvement, extension, enjoyment or maintenance of a water-supply plant or the furnishing of water to such city and its inhabitants, situated either within or without any city.

"Sec. 2. The mayor and council of any city desiring to exercise the power of eminent domain for the purpose hereinbefore mentioned shall by resolution declare it necessary and for the best interests of the city to proceed under the provisions of this act to acquire for said city such property, describing the property condemned and appropriated.

"Sec. 3. Upon the passage of such resolution as is specified in the next preceding section, the city passing the same may apply to the judge of the district court of the county in which said city is located, or to the judge of any court of general jurisdiction having a clerk and seal of the county in which said city is located, for the appointment of three commissioners to make appraisal of the value of the property so condemned and for the assessment of all damages. Said commissioners shall be residents and freeholders of the county in which said city is located. Such appointment shall be made by the judge of the court on the written application of the city by its attorney or legal representative; the appointment shall be made in writing, under the hand of the judge, and delivered to the city applying therefor; the application for the certificate of appointment shall be recorded in the office of the register of deeds of the county in which said city is located. In case any vacancy occurs, or any such commissioner or commissioners refuse to serve on such board, the judge of the court to which application is made shall appoint, in the manner herein provided, some other person or persons having the qualifications herein provided. Such commissioners shall be sworn to honestly and faithfully discharge their duties as such commissioners.

"Sec. 4. Upon their appointment and qualification the said commissioners shall give notice of the time and place of their meeting to value property sought to be acquired by the city and to assess the damages. Such notice shall be addressed 'to whom it may concern,' and given by publication for thirty successive days (excluding Sundays) next preceding the time fixed for said meeting in some daily newspaper published in such city. Said notice shall specify that the purpose of the meeting of the said commissioners is to ascertain and determine the value of property condemned and the damages. At the time fixed by said notice, or at the time to which said meeting may be adjourned, the said commissioners shall proceed to ascertain and determine the value of the property condemned by the city and the damages. They may examine experts and resort to all means within their power to arrive at the value of the property condemned, and the owner or any one interested therein, or who may be affected by the condemnation proceedings, may be heard before said commissioners, and may produce such testimony before them to enable said commissioners to arrive at the fair and equitable value of the property condemned and the damages. The said commissioners may adjourn as often and for such length of time as may be deemed convenient, and may during any adjournment perfect or correct all errors or omissions in the giving of notice by serving new notices or making new publications, citing corporations or individual property owners who have not been notified or to

whom defective or insufficient notice has been given, and notice of any adjourned meeting shall be as effective as notice of the first meeting of the commissioners. Upon the completion of their hearing and deliberations the said commissioners shall make their report in writing, and shall forthwith file the same with the clerk of the county in which the city is located. Said report shall be filed within twenty days from the date of the last meeting of said commissioners."

"An appeal shall be had to the district court of the county in which such city is located by the owner or any person interested or aggrieved, from the determination of the commissioners as to the value of the property appropriated and for all damages sustained by such interested or aggrieved party, in the same manner as appeals are granted from the judgment of a justice of the peace to the district court; and said appeal and all subsequent proceedings shall only affect the amount of compensation to be allowed, and shall not delay the city in taking possession of the property condemned, if said city shall deposit with the treasurer of the county in which said city is located, as herein provided, for the use and benefit of the owners of said property or others interested therein, including parties having liens thereon, the amount of the award allowed. Upon the making of said deposit said city may at once take possession of the property condemned and manage and control the same as hereinafter specified. Said city shall, in addition to the amount awarded by the commissioners, be liable for such sums in excess thereof as may be recovered on any appeal, and for the costs of said appeal, but if judgment for a less sum than awarded by the commissioners is recovered, the city shall not be liable for a sum in excess of such judgment nor for the costs of said appeal."

"Sec. 7. Within ten days after the commissioners shall file their report and proceedings under this act it shall be the duty of the mayor and council of the city instituting the condemnation proceedings herein provided for to call a special election in said city for the purpose of submitting to the electors of said city a proposition to vote bonds to raise money to pay the amount of the award made by the commissioners in their report. If a majority of the electors voting upon the proposition so submitted shall favor the same, the mayor and council of said city are hereby authorized to enact a proper ordinance providing for the issuance of bonds, which bonds shall run for not exceeding thirty years nor bear a greater rate of interest than six per cent. per annum, to be sold at par, payable semi-annually, and said bonds to be sold by the city and the proceeds thereof used for the payment of the award of commissioners. All bonds issued under the provisions of this act shall contain a recital that the same are issued under the provisions of this act and in conformity with its provisions, and such recital shall be conclusive in favor of all persons holding such bonds against the city and the taxpayers thereof that all conditions precedent and proceedings to authorize the issuing of such bonds have been made and had in conformity with this act. If the electors of the city vote bonds to raise money to pay the award fixed in the report of the commissioners, the city shall as soon as practicable thereafter pay the amount of the award to the county treasurer of the county in which the said city is located, and the right of possession to the property condemned shall thereupon vest absolutely in the city, and such city shall have the right to enter into and take possession thereof, and thereafter the said city shall hold the plant and property appropriated free from all liens and encumbrances.

"Sec. 8. If the city shall cause to be paid to the county treasurer of the county in which the city is located the amount in full of the award, such treasurer shall, upon demand of the persons severally entitled thereto, pay over the amounts of such fund to such persons as shall be respectively entitled thereto. Immediately upon the payment to the county treasurer of the amount of the award made by the commissioners any lien holder, mortgagee or holder of any encumbrance of the plant or property condemned shall have the right to commence an action in any court of general jurisdiction in the county in which said city is located, for the purpose of determining to whom the money so deposited shall be paid. In any such action service may be made by publication against defendants who are nonresidents of the state, in the

same manner as is now provided for such service by the code of civil procedure of the state of Kansas in case of non-resident defendants."

Thereafter the city of Kansas City, Kan. (hereinafter called the "City"), by its mayor and common council, passed a resolution declaring it necessary and for the best interests of the city to avail itself of the power conferred to condemn and take over the property and plant of the Metropolitan Water Company (hereinafter called the "Water Company") in the city, and describing such property, all as provided by section 2 of the act. Thereupon a petition was caused to be prepared by the city and presented to the judge of the district court of Wyandotte county, the county in which the city is located, praying the appointment of three commissioners to appraise the property about to be taken over, as provided by section 3 of the act. On the presentation of this petition, and in pursuance of the provisions of the act, the honorable judge of the district court appointed three commissioners, freeholders of the county, and resident citizens of the city, to make an appraisal of the property of the water company, and file a report, as provided by section 4 of the act. Thereupon the water company filed its petition and bond, in due form of law, for the removal of the controversy so raised between it and the city into this court. And upon the refusal of the judge of the district court to order a removal of the cause, and as the commissioners appointed were proceeding under the authority conferred upon them by their appointment to appraise the property and report, as ordered by the judge of the district court, the water company presented to this court its bill of complaint in due form, praying an injunctive order against said commissioners and the city, commanding them to proceed no further in making such appraisal, and filing a report of their findings, as provided in the act.

The grounds upon which the water company predicated its right to the relief sought by the bill are three in number, briefly stated as follows: (1) That the act is unconstitutional and void: (a) Because special legislation in contravention of the state Constitution; (b) because the act provides for the taking of property by the exercise of the power of eminent domain without making provision for just compensation to the owner; (2) that the commissioners appointed are citizens and resident taxpayers of the city, and, in consequence, are directly interested in a financial way in the controversy, hence are disqualified to act as commissioners; (3) because, by the filing of the petition and bond for removal of the controversy into this court, the jurisdiction and power of the commissioners and the city to proceed further ceased, and this court acquired jurisdiction. At a full hearing and argument before the court, had on notice, the right of relief was denied the water company on the ground first stated in its bill of complaint, and the act held constitutional. However, a restraining order was granted the water company on the ground that the controversy is one in its nature removable into this court, as the amount in controversy is sufficient to confer jurisdiction on this court, and as the water company and the city, parties to this controversy, are citizens of different states, it was therefore held the controversy was properly

removed and now pending herein, to be further proceeded with under the orders of this court. This view of the case rendered the question raised as to the disqualification of the commissioners appointed by the judge of the district court unnecessary of decision, and that question was expressly left undetermined. The city has now filed and presents its motion to remand this proceeding to the state court. It has also filed its motion to vacate the restraining order granted in the equity suit.

The sole question presented by these motions is this: Is the proceeding to condemn the property of the water company, in its very nature, as made by the act in question, such a controversy as was properly removable into this court at the time the petition and bond for removal were filed? It is freely conceded by counsel for the city, if the water company should feel aggrieved at the appraisal made by the commissioners, when such appraisal shall have been made, and should then appeal from the award of damages made to it by the commissioners to the district court, as by the act provided, the water company might then remove such controversy, arising on the amount of damages awarded, into this court for determination. But it is most earnestly insisted by counsel for the city that prior to that stage of the proceedings there can be no controversy between the parties removable into this court, hence the motion to remand must be sustained. Is this contention sound and in harmony with the conclusions reached in the adjudicated cases binding on this court? It will be noted section 7 of the act, among other things, provides:

"If the electors of the city vote bonds to raise money to pay the award fixed in the report of the commissioners, the city shall as soon as practicable thereafter pay the amount of the award to the county treasurer of the county in which the said city is located, and the right of possession to the property condemned shall thereupon vest absolutely in the city, and such city shall have the right to enter into and take possession thereof, and thereafter the said city shall hold the plant and property appropriated free from all liens and incumbrances."

Therefore, the result of the contention made by counsel for the city is that, by virtue of the terms of the act in question, the city may institute and carry forward the condemnation proceedings to the point of divesting not only the owner of the property of its title in and right to possession of the property, but may cut off and destroy all fixed liens and incumbrances on such property, and divest the owner of the very possession of the property itself, before there is raised such a judicial controversy between the parties as may be removed into this court.

In the light of the adjudicated cases, may that be done? I think not. And I am further of the opinion the recent case of *Traction Company v. Mining Company*, 196 U. S. 239, 25 Sup. Ct. 251, 49 L. Ed. 462, is decisive of the very question presented here. True, in that case, before the controversy was removed by the mining company into the federal court, the commissioners appointed by the county court had made their report, and this report was pending in the county court for confirmation; but the act further provided, if exceptions were filed to such report, a jury was required to be impaneled to try the issues

of fact raised by such exceptions, and either party could appeal to the Circuit Court, where a trial de novo might be had. But before the condemning party was entitled to take possession of the property condemned, in that case, it was required to pay the amount fixed by the commissioners and all costs of the proceedings, if no appeal were taken, and, if an appeal was taken to the Circuit Court, the act expressly provided that the owner must be paid all damages assessed on such appeal and all costs before the owner could be divested of its property. In other words, under the provisions of the Kentucky statutes, the questions of fact raised by the exceptions filed to the report of the commissioners was triable, in the first instance, to a jury impaneled in the county court, after notice to the owner of the property. Before the first instance trial of such questions of fact the case was held properly removable into the federal court, although the statute of that state provided for an appeal from the judgment entered on such trial to the Circuit Court, and a trial de novo there, the title of the owner to be divested only after payment of damages assessed and all costs on such appeal. Under the Kansas statute here involved the first instance trial is before the commissioners appointed by the judge of the district court, after notice to the parties, and the title and right of possession of the owner is divested and all fixed liens on the property cut off on payment of the amount awarded at the first instance trial, if the electors of the city approve the purchase at the price fixed by the commissioners, notwithstanding an appeal, as to the amount, is allowed by the owner to the district court. In delivering the opinion in the Traction Company Case, Mr. Justice Harlan, after adverting to the fact that no case or proceeding may be removed into the federal court unless it might have been there instituted in the first instance, says:

"The case, as made in the county court, was, beyond question, a judicial proceeding; it related to property rights, the parties are corporate citizens of different states, and the value of the matter in dispute, exceeds the amount requisite to give jurisdiction to the circuit court. It was therefore a proceeding embraced by the very words of the Constitution of the United States, which declares that the 'judicial power shall extend * * * to controversies * * * between citizens of different states,' as well as by the act of 1837 (Act March 3, 1837, c. 373, 24 Stat. 552 [U. S. Comp. St. 1901, p. 508]) which declares "that the Circuit Courts of the United States shall have original cognizance, concurrent with the courts of the several states, of all suits of a civil nature, at common law or in equity, where the matter in dispute exceeds, exclusive of interest and costs, the sum or value of two thousand dollars, * * * in which there shall be a controversy between citizens of different states." In view of these explicit provisions it is clear that the proceeding in the county court was a suit or controversy within the meaning both of the Constitution and of the judiciary act. We could not hold otherwise without overruling former decisions of this court."

The justice then proceeds to a review of the former decisions by that court. By a parity of reasoning, why, then, is not the case made up and triable before the commissioners appointed by the judge of the district court removable into this court? It relates to property rights. The owner of the property, and the city attempting to take this property for its own use, are corporate citizens of different states. The value of the property is largely in excess of the amount required to

confer jurisdiction on this court. It is true, as contended by counsel for the city, when the Traction Company Case was removed it was a proceeding pending in a court—that is, in a judicial tribunal—which both in name and in the strictest and fullest sense of the word was a court in all respects, and that the commissioners appointed by the judge of the district court in the present matter did not constitute a court in the strict sense in which that word is used. Wherefore, based upon this distinction it is urged by counsel for the city that the proceeding removed into this court was not a suit or controversy pending in a court of the state, and therefore not removable. However, it is not thought such distinction, if conceded to be well taken, or found to exist in fact, is either material or decisive of the question presented. For, if it be found to exist, the distinction is one of mere form, and not of substance, as observed by Mr. Justice Harlan in the Traction Company Case:

“Besides, a court always looks to substance and not to mere form. Mere forms are not of vital consequence in cases of condemnation. *Kohl v. United States*, 91 U. S. 367, 23 L. Ed. 449; *United States v. Jones*, 109 U. S. 513, 3 Sup. Ct. 346, 27 L. Ed. 1015.”

The reason why the proceeding removed into this court is judicial in character is apparent from the power exercised by the commissioners appointed by the district court, and the district court in making such appointment. A judge of the district court in Kansas, at his chambers, may exercise such judicial powers as are conferred by law. The Constitution provides (article 3, § 16) as follows:

“The several justices and judges of the courts of record in this state shall have such jurisdiction at chambers as may be provided by law.”

The hearing and determination of the petition presented by the city to the judge of the district court for the appointment of commissioners called for the exercise of judicial discretion and power. There was involved the sufficiency of the showing made by the petition under the law; the personnel and qualifications, under the law, of the persons named, in case the application found sufficient in law and the relief prayed therein granted; and the form of the order prescribing the duties of such commissioners, as fixed by the law of their appointment.

Again, article 3, § 1, of the Constitution provides for the exercise of the judicial power of the state as follows:

“The judicial power of this state shall be vested in a Supreme Court, district courts, probate courts, justices of the peace, and such other courts inferior to the Supreme Court, as may be provided by law.”

While, as contended by counsel for the city, the commissioners appointed in this proceeding are not denominated in the act as a court, yet, as I conceive, they might have been so named, and the fact that they were not so named is not the test to be applied to the character of their acts, but rather the inquiry must be, does the performance of the duties enjoined upon them by the statute of their creation call for the exercise of judicial powers? By section 4 of the act above quoted, upon their appointment and qualification they are required to give notice of the time and place at which they will meet to value the

property. The form of the notice and the manner of its service upon the owner, and those interested in the property, to confer jurisdiction, is prescribed by the act. They are given power to adjourn the meeting fixed in the notice from time to time, as they may determine. At such meetings they are empowered to call and examine witnesses and take all steps and measures within their power to determine the true value of the property, and in the end to make a report, in writing, and provide for its filing and record, which report, when made, conclusively and forever determines the price which the city must pay to entitle it to take over the absolute title and possession of the property condemned against the rights of all the world, and over the protest and against the will of the water company, the owner, subject alone to the will of the voters of the city. And the effect of this determination may in no wise be changed or modified on appeal by the water company, save only in the contingency that, if the amount of the damages sustained for the loss of the property awarded by the commissioners to the owner is increased on such appeal, the city is obligated for its payment. It surely cannot be doubted the powers thus conferred by the act upon, and exercised by, the commissioners are, in the strictest sense and to their fullest extent, judicial in their nature, and their report is as much a judicial determination of the rights of the parties to the controversy as would be that of a verdict and judgment thereon in a constitutional court of our land. And, in my judgment, it was within the power of the Legislature to make the report of the commissioners final and conclusive between the parties and beyond appeal, an appeal being merely an act of grace on the part of the Legislature. The inherent nature of the proceeding and its binding effect on the parties in interest stamp its character. The name given by the law to the body exercising the power is an immaterial matter of form. As said by Mr. Justice Holmes in *Mason City R. R. v. Boynton*, 204 U. S. 570, 27 Sup. Ct. 321, 51 L. Ed. 629, which involved a controversy as to whether an appellant in a condemnation proceeding under the laws of the state of Iowa, and held by the Supreme Court of that state to be plaintiff in the action, could remove the controversy he had appealed into the federal court:

"Probably, too, the position of the parties under the act of Congress should be determined upon general consideration without regard to what has happened. Looked at as a whole, the Iowa statutes provide a process by which railroads and others may acquire land for their purposes which the owner refuses to sell. The first step is the valuation. Whether it is part of the case or not, it is a necessary condition to the proceedings in court. Against the will of the owner the title to the land is not acquired until the case is decided and the price paid. The intent of the railroad to get the land is the mainspring of the proceedings from beginning to end, and the persistence of that intent is the condition of their effect."

From a consideration of the many cases cited and commented on by counsel in their printed briefs, I am of the opinion a state is wholly without power, by the mere form of procedure prescribed, to deprive the owner of property sought to be taken by condemnation proceedings from removing such proceedings into a federal court, if such owner be a citizen of a foreign state and the value of the property exceeds the jurisdictional amount. For to concede such power to

the state would admit the right of the state by mere statutory enactment to preclude a court of the United States from the exercise of its established jurisdiction under the Constitution and laws of our country, which are supreme and binding on the state and individual citizens alike. And, indeed, I do not find the question here presented to be the rock on which the members of the highest court of our land have split in their consideration of cases kindred to this. The controlling and important question on which the members of that high court have divided was this: The exercise of the power of eminent domain is admitted by all to be the exercise of a power of sovereignty itself. Therefore it has been stoutly contended, on the one hand, the exercise of this sovereign power by a state could be carried forward in such manner and by such agencies as the state might provide, untrammelled by any interference from the courts of the nation; that such courts had no jurisdiction of a controversy which might arise between the state in the exercise of this sovereign power, and the owner of property sought to be taken, either in the first instance, or by removal from a court or other tribunal of the state to which the Legislature had committed the exercise of such power. On the other hand, it was contended, where the fundamental law imposes conditions on the exercise of this sovereign power by a state or its agencies, the question of the presence or absence of such imposed conditions from any given case involve a judicial inquiry, over which the national courts might take jurisdiction, either original or by removal, if the requisite jurisdictional facts as to citizenship and amount in controversy exist. And, as clearly appears from a reading of the opinions, the conflict raised by these two contentions was the question threshed out in *Kohl et al. v. United States*, 91 U. S. 367, 23 L. Ed. 449, *Boom Co. v. Patterson*, 98 U. S. 403, 25 L. Ed. 206, *Searl v. School District No. 2*, 124 U. S. 197, 8 Sup. Ct. 460, 31 L. Ed. 415; and kindred cases, the latter contention being ultimately and finally established as the settled law of the land by a divided court in the *Traction Company Case*, 196 U. S. 239, 25 Sup. Ct. 251, 49 L. Ed. 462, to which reference has been made, as clearly appears from the language used by Mr. Justice Harlan in delivering the opinion:

"It is suggested that the state Legislature might have consummated the taking of the property of the Delaware corporation by means of a nonjudicial tribunal, and thus left open simply the question of compensation to the owner of the property taken. We do not perceive that this suggestion is at all material in the present discussion, for the state has chosen to provide for the taking by means of what is conceded to be a suit in one of its judicial tribunals. It is, in effect, conceded that the circuit court may be given jurisdiction of the question of compensation. But the contention is, that in no case can the judicial power of the United States be invoked until the question of taking is consummated by a proceeding in the particular local tribunal designated by the state. This view, it is supposed, finds support in the cases in which it has been held that an original suit directly against a state, or a suit against an officer of the state which, by reason of the particular relief sought, is in effect a suit against the state, may be limited by the state to suits brought in one of its own courts. *Smith v. Reeves*, 178 U. S. 436, 20 Sup. Ct. 919, 44 L. Ed. 1140. This illustration is wide of the mark; for the mandate of the Constitution of the United States (eleventh amendment) is that 'the judicial power of the United States shall not be construed to extend to any suit in law or equity commenced or prosecuted against one of the

United States by citizens of another state or by citizens or subjects of any foreign state'; whereas, the judicial power of the United States and the original jurisdiction of the Circuit Courts, whatever may be ordained by state legislation, extends to suits in which there is a controversy between citizens of different states. The exercise by the Circuit Courts of the United States of the jurisdiction thus conferred upon them is pursuant to the supreme law of the land, and will not, in any proper sense, intrench upon the dignity, authority, or autonomy of the states; for each state, by accepting the Constitution, has agreed that the courts of the United States may exert whatever judicial power can be constitutionally conferred upon them. In the exercise of that power a Circuit Court of the United States, sitting within the limits of a state and having jurisdiction of the parties, is, for every practical purpose, a court of that state. Its function, under such circumstances, is to enforce the rights of parties according to the law of the state, taking care, always, as the state courts must take care, not to infringe any right secured by the Constitution and the laws of the United States. It should, however, be remarked that there is nothing in the Kentucky statute which indicates any purpose on the part of the Legislature of that commonwealth to fly in the face of the above cases or to evade the principles announced in them. It is not to be implied from the statute in question that the state intended to exclude or supposed that it could exclude from the federal courts jurisdiction of any suit to which the judicial power of the United States extended."

That further dispute over this difficult and important question is conceded by the Supreme Court itself as closed, appears from the language employed by Mr. Justice Holmes delivering the opinion of the court in *Mason City R. R. v. Boynton*, supra, wherein he says, in opening the discussion of that case:

"In *Madisonville Traction Company v. Saint Bernard Mining Co.*, 196 U. S. 239, 25 Sup. Ct. 251, 49 L. Ed. 462, it was decided that proceedings of this character could be removed to the United States Circuit Court."

It follows, from what has been said, I am of the opinion the controversy made before the commissioners in this case was judicial in its nature and properly removable into this court by the water company, a citizen of a foreign state. That this court by the removal has jurisdiction over the controversy raised between the parties by the proceedings taken by the city under the statute.

The motion to remand will therefore be overruled and denied. It is so ordered.

If the city desires to proceed with the condemnation, under the statute, in this court, commissioners to appraise and condemn the property, as provided in the act, will be appointed on application made for that purpose on one day's notice to opposing party or its counsel. Or, should counsel for the respective parties agree and stipulate as to the personnel of such commissioners, the court will at once make such appointment on the filing of the stipulation.

METROPOLITAN WATER CO. v. KANSAS CITY et al.

(Circuit Court, D. Kansas, First Division. July 4, 1908.)

No. 8,720.

1. STATUTES (§ 93*)—CONSTITUTIONALITY—SPECIAL LEGISLATION—MUNICIPAL CORPORATIONS.

Const. Kan. art. 12, § 1, provides that "the Legislature shall pass no special act conferring corporate powers." Article 2, § 17, provides that "all laws of a general nature shall have a uniform operation throughout the state, and in all cases where a general law can be made applicable no special law shall be enacted." Art. 12, § 5, provides that "provision shall be made by general law for the organization of cities, towns and villages." *Held* that, under the construction placed on such provisions by the Supreme Court of the state, Laws Kan. 1908, p. 30, c. 33, which authorizes cities of the first class having a population of over 50,000 to acquire waterworks property by condemnation and to maintain and operate the same, is not in violation of any of such provisions, although when enacted there was but one city in the state to which it applied, since, while it confers corporate powers, it is not special legislation within the state decisions; nor is it invalid because it does not provide the means to be employed in making payment of any increase in the compensation awarded for property condemned on appeal from the commissioners, it being expressly provided that such an appeal may be taken, and that the city shall be "liable" for the increased amount that may be recovered.

[Ed. Note.—For other cases, see Statutes, Cent. Dig. §§ 101, 102; Dec. Dig. § 93.*]

2. REMOVAL OF CAUSES (§ 42*)—SUITS REMOVABLE—CONDEMNATION PROCEEDINGS.

A proceeding instituted by a city to condemn the property of a water company under Laws Kan. 1908, p. 30, c. 33, by an application to a state court for the appointment of commissioners to appraise the property as provided by such act, is a suit at law removable into a federal court where the requisite amount is involved and the defendant is a citizen of another state, and the timely filing of a proper petition and bond for such removal deprives the state court of jurisdiction to proceed further therein.

[Ed. Note.—For other cases, see Removal of Causes, Dec. Dig. § 42.*]

Proceedings under power of eminent domain as civil suits under laws relating to removal of causes to federal courts, see *South Dakota Cent. Ry. Co. v. Chicago, M. & St. P. Ry. Co.*, 73 C. C. A. 183.]

In Equity. On motion for preliminary injunction.

Miller, Buchan & Miller, Samuel Maher, and Willard P. Hall, for Metropolitan Water Company.

H. L. Alden, City Counselor, for defendants.

POLLOCK, District Judge. The bill presented in this case by complainant seeks a decretal order against defendants, restraining and enjoining them from proceeding further in an attempt made to condemn and take over the waterworks plant of complainant located and operated by it in the defendant city. The endeavor of the city to possess itself of this water plant of complainant is made under the provisions of chapter 33, p. 30, Laws (Special Session) 1908, of the Legislature of this state, entitled "An act relating to cities of the first class having a population of more than fifty thousand (inhabitants), and relating

*For other cases see same topic & § NUMBER in Dec. & Am. Digs. 1907 to date, & Rep'r Indexes

to the acquisition and maintenance of waterworks by and the supplying of such cities and their inhabitants with water."

The facts in this matter necessary to a decision of the contentions made are as follows: For the past five years complainant has been operating its water plant in the defendant city without any franchise right from the city to so do, its franchise having expired by lapse of time, and the city having refused to grant such further extension of such franchise as was acceptable to complainant. In this condition of affairs complainant cannot extend its works commensurate with the growth and needs of the city and its inhabitants, and will not improve its plant. Therefore the inhabitants are made to suffer for want of an adequate supply of potable water for domestic use, and for want of sufficient protection from the dangers by fire, hence the city has resolved to take over the plant under the power of eminent domain conferred upon it by the above-mentioned act. To this end, proceeding under the provisions of the legislative act cited, defendant city on the 28th day of April, 1908, passed a resolution of the common council of the city declaring its intention to avail itself of the provisions of the act in the condemnation of certain property therein described, the same being the property which comprises the water plant of complainant in defendant city, and praying in said resolution the appointment by the honorable judge of the district court of the county of three commissioners, as provided in the act, to estimate and appraise the value of said property, and make and file an award of damages accruing to complainant from the taking by the city of said waterworks plant. Thereafter, and on the 6th day of May, 1908, upon presentation of said resolution to the judge of the district court of the state, there was appointed, as commissioners under the provisions of the act, defendants herein, Harry Darby, P. W. Goebel, and O. W. Sheperd, each and all citizens and taxpayers in defendant city and the county of Wyandotte, this state, in which said city is located. However, theretofore, and on the 4th day of May, complainant herein presented its petition and bond in due form to the honorable judge of the state court for removal of said controversy into this court. An order of removal by that court was refused complainant solely on the ground that the controversy presented was not such as is removable under the provisions of the federal judiciary act. Thereafter, complainant caused a transcript of the record to be lodged in this court and on June 24, 1908, the commissioners appointed by the state court being, as averred in the bill of complaint filed herein, about to make and file their award of damages, presented and filed its bill praying an order of this court restraining and enjoining the defendant city, and the commissioners therein named, from further proceeding in the matter. The grounds upon which this injunctive relief is demanded are these: (1) That the act under which defendants are proceeding is unconstitutional and void for two reasons: (a) Because it is special legislation; (b) because no provision is made in the act for making just compensation to complainant for its property. (2) It is also contended by complainant the present proceeding should be enjoined because the commissioners appointed are disqualified to act on account of interest in the controversy. (3) It is further contended the controversy was properly re-

moved into this court before the present commissioners were appointed, therefore the judge of the state court was without jurisdiction or power to make such appointment, and the commissioners are in consequence without authority to act in the premises and should be enjoined, although the act should be held valid legislation. And, further, that this court should grant the order here demanded in protection of its jurisdiction over the controversy acquired by such removal to this court. Of these contentions in their order.

As to the claimed unconstitutionality of the act, section 1 of article 12 of the Constitution provides as follows:

"The Legislature shall pass no special act conferring corporate powers."

Section 17 of article 2 provides:

"All laws of a general nature shall have a uniform operation throughout the state; and in all cases where a general law can be made applicable, no special law shall be enacted."

Section 5 of article 12 provides:

"Provision shall be made by general law for the organization of cities, towns and villages."

It must be conceded, I think, that the act in question confers corporate powers upon the defendant city. As said in *Gilmore v. Norton*, 10 Kan. 504:

"Any power conferred upon a corporation, and to be exercised by the corporation, is a corporate power."

Therefore, if the act in question be special legislation, its claimed invalidity must follow. Is it special legislation? The title of the act reads as follows:

"An act relating to cities of the first class having a population of more than fifty thousand (inhabitants), and relating to the acquisition and maintenance of waterworks and the supplying of such cities and their inhabitants with water."

The purpose expressed by the title is fully carried out in the body of the act. The contention made by complainant is, as the cities of the state are created and classified by general laws, the act in question in limiting its operation to one of a class—that is, to a city of the first class having a population of over 50,000—without any reason for such limitation, and as the defendant city is the only city of the first class in the state having a population of more than 50,000 souls, and as the classification made is wholly arbitrary and without reason, therefore the act of necessity is special.

On the other hand, it is contended by defendants that the act is general in terms, and as it may relate to any city of the first class in the state when it shall attain a population of more than 50,000 souls, although there is no other city in the state having the requisite amount of population at this time, yet as it may operate upon any other city of the first class when such population is attained, the act is general and not special. While I am free to confess very cogent and powerful arguments may be adduced in support of the contention made by complainant that this act is special legislation and therefore void, yet the construction placed upon the provisions of the Constitution of the state

by its highest judicial tribunal must control here. From a careful consideration of some of the many cases emanating from that tribunal touching the question here presented, I am inclined to the opinion the claimed invalidity of the act is left in such doubt that I deem it my duty as a trial judge to uphold the act and allow it to be stricken down only by some appropriate reviewing tribunal after a more thorough and exhaustive research and consideration of the question presented than time will permit me to now give. A few of the cases from that court supporting or tending to support the validity of the classification made in the act are: *State v. Downs*, 60 Kan. 788, 57 Pac. 967; *Parker-Washington Co. v. Kansas City*, 73 Kan. 722, 85 Pac. 781; *Wulf v. Kansas City (Kan.)* 94 Pac. 207; *Com'rs Wyandotte Co. v. Abbott*, 52 Kan. 148, 34 Pac. 416; *Riley v. Garfield Township*, 58 Kan. 299, 49 Pac. 85.

Nor, in my judgment, is the act void because it does not provide the means to be employed in making payment or enforcing collection of any increase in the amount of the award made by the commissioners on appeal and trial before a jury, for the act in express terms creates a liability on the part of the city for such increased amount and costs of appeal in case the trial jury are of the opinion the award of the commissioners is not sufficient in amount to make just compensation to complainant. The act provides for an appeal, and employs the following language:

"Said city shall, in addition to the amount awarded by the commissioners, be liable for such sums in excess thereof as may be recovered on any appeal, and for the costs of said appeal, but if judgment for a less sum than awarded by the commissioners is recovered, the city shall not be liable for a sum in excess of such judgment nor for the costs of said appeal."

Hence, as the award of the jury on appeal fixing the just compensation to be made for the taking of the property as provided by the Constitution in the exercise of the power exerted is in form a judgment based on a liability created by statute, it is manifest the city could not retain the property and refuse payment of the judgment awarded. Or, if such attempt should be made on the part of the city, ample means are at hand to enforce the liability of the city as created in the act. Therefore I am constrained to hold the act in question valid legislation.

In the view of the matter I have taken, it becomes unnecessary at this time to pass upon the very important and extremely difficult question of the claimed disqualification of the commissioners appointed by the honorable judge of the state court, on account of their interest in the controversy. It is, however, not unworthy of notice that under repeated decisions of the Supreme Court of this state the commissioners herein appointed are not qualified jurors to sit in the trial of a case between the parties to this suit. The reason the decision of that question is not deemed important here is this: I think it must be held the appointment made was without jurisdiction or power in this case; in other words, that the controversy made between the parties is in its nature a special judicial proceeding, such as may be and was properly removable by complainant into this court before the appointment of

the commissioners was made. For the purpose of obtaining a clear understanding of the rights of the parties to this controversy, and the judicial questions involved, it may be well to inquire into the precise nature of the rights asserted by the defendant city under the provisions of the act of the Legislature in question, on the one hand, and the defenses urged by complainant against the assertion of such rights by the city, on the other.

The ultimate object to be attained by the city through this special proceeding is, by the exercise of the sovereign power of eminent domain, to take the property of complainant without its consent and against its will in the manner such power was conferred upon the city by the sovereign state through its legislative branch. In order to accomplish this purpose, it is necessary and prerequisite that the value of the property sought to be thus taken shall be first ascertained, and the act of making such ascertainment is in its essential and inherent nature a judicial act, regardless of the method adopted by the Legislature. For the legislative branch of the government would be powerless under the Constitution to provide any method of estimating the just compensation to be made complainant for its property, taken through the exercise of the power employed, which does not provide a judicial determination of that question. Mr. Justice Strong, delivering the opinion of the court in *Kohl et al. v. United States*, 91 U. S. 367, 23 L. Ed. 449, said:

"The right of eminent domain always was a right at common law. It was not a right in equity, nor was it even the creature of a statute. The time of its exercise may have been prescribed by statute, but the right itself was superior to any statute. That it was not enforced through the agency of a jury is immaterial, for many civil as well as criminal proceedings at common law were without a jury. It is difficult, then, to see why a proceeding to take land in virtue of the government's eminent domain, and determining the compensation to be made for it, is not, within the meaning of the statute, a suit at common law, when initiated in a court. It is an attempt to enforce a legal right. It is quite immaterial that Congress has not enacted that the compensation shall be ascertained in a judicial proceeding. That ascertainment is in its nature at least quasi judicial. Certainly no other mode than a judicial trial has been provided."

Again, complainant denies the validity of the act under which the city attempts to exercise the power of taking its property, hence it has the right to controvert and litigate with the city its power to proceed under the act in question at all. And, being a citizen of a state other than this, and the property sought to be taken being of large value, it has the right to appeal to this court for a determination of not a part only, but all, of the issues involved in such controversy. For it is not only apparent in reason, but the settled law of this state, if complainant should have acquiesced in the exercise of the power claimed by the city, through the commissioners appointed, until an award should have been made and filed by them and the duties of the commission at an end, and then have appealed from the award made, it would have estopped itself by such appeal from questioning the right of the city to proceed or the qualifications of the commissioners thus appointed, and limited the scope of the inquiry to the amount of award to be made as the just compensation for the property taken. In Rail-

way Co. v. Railway Co., 67 Kan. 569, 70 Pac. 939, 73 Pac. 899, it is said:

"Under the statutes the condemning company has the absolute and uncontrolled direction of the condemnation proceeding. The commissioners lay off the route for such distance as the company desires, of such width as the company desires, within the limits of one hundred feet, and upon such location as the company desires. If the company desires the land of another railroad company, the coveted quantity is surveyed and appraised, and a report of the proceeding made and filed. Upon making a deposit of damages and completing the county records, the company has the right to occupy the land, and by building the road may acquire its perpetual use. Against this proceeding the statute has given the landowner no remedy except by appeal, and by strict phraseology has limited the question to be tried upon appeal to the matter of damages alone. * * *

"If, therefore, the landowner either accepts the condemnation money or takes an appeal, the perpetual use of the land vests in the condemning company when compensation is made. And if an appeal be taken, no jurisdiction can vest in the appellate court to try the rightfulness of the appropriation of a part of any specific tract, or to eliminate from the condemnation proceeding a part of a tract wrongfully taken, or upon such elimination to apportion gross awards of damages for land taken and for injury to land not taken. * * *

"Under these circumstances the only adequate remedy available to the landowner is an injunction from a court of equity."

Hence complainant, in recognition of accepted principles of the law, upon the institution of this special proceeding by defendant city against it to take over its property through the exercise of judicial powers, in the first instance applied for a removal of the entire controversy, involving not only the compensation to be made, but the right to take the property at all into this court, to the end that all judicial questions might be here presented and determined; and, in the exercise of its right of removal and the perfection of such transfer of jurisdiction, caused to be prepared and filed herein such transcript of the record as the exigencies of the case permitted, and such removal case is now pending in this court undetermined. Such right of removal in my judgment was timely exercised in a proper manner, and operated to deprive the state judge of all jurisdiction to act in the premises, and to confer jurisdiction of the entire controversy upon this court, as reference to a few of the adjudicated cases will show.

In *Boom Co. v. Patterson*, 98 U. S. 403, 25 L. Ed. 206, Mr. Justice Field, delivering the opinion of the court, said:

"But notwithstanding the right is one that appertains to sovereignty when the sovereign power attaches conditions to its exercise, the inquiry whether the conditions have been observed is a proper matter for judicial cognizance. If that inquiry take the form of a proceeding before the courts between parties—the owners of the land on the one side, and the company seeking the appropriation on the other—there is a controversy which is subject to the ordinary incidents of a civil suit, and its determination derogates in no respect from the sovereignty of the state."

In *Searl v. School District No. 2*, 124 U. S. 199, 8 Sup. Ct. 461 (31 L. Ed. 415), a condemnation case arising under the statutes of Colorado, Mr. Justice Matthews, delivering the opinion of the court, said:

"The fact that the Colorado statute provides for the ascertainment of damages by a commission of three freeholders, unless at the hearing a defendant shall demand a jury, does not make the proceeding from its commence-

ment any the less a suit at law within the meaning of the Constitution and acts of Congress and the previous decisions of this court. * * * It is an adversary judicial proceeding from the beginning. The appointment of commissioners to ascertain the compensation is only one of the modes by which it is to be determined. The proceeding is, therefore, a suit at law from the time of the filing of the petition and the service of process upon the defendant."

In *Traction Company v. Mining Company*, 196 U. S. 239, 25 Sup. Ct. 251, 49 L. Ed. 462, Mr. Justice Harlan, delivering the opinion of the court, quotes with approval the language employed by Mr. Justice Brewer in *Colorado Midland Railway Co. v. Jones* (C. C.) 29 Fed. 193, as follows:

"I do not suppose that a state can, by making special provisions for the trial of any particular controversy, prevent the exercise of the right of removal. If there was no statutory limitation, the Legislature could provide for the trial of many cases by less than a common-law jury, or in some other special way. But the fact that it had made such different and special provisions would not make the proceedings any the less a trial, or such a suit as, if between citizens of two states, could not be removed to the federal courts. If this were possible, then the only thing the Legislature of a state would have to do to destroy the right of removal entirely would be to simply change and modify the details of procedure."

In *Smith v. Adams*, 130 U. S. 167, 9 Sup. Ct. 566, 32 L. Ed. 895, Mr. Justice Field, delivering the opinion of the court, in referring to the clauses of the Constitution and the statutes relating to the judicial power and the courts of the United States, said:

"By those terms are intended the claims or contentions of litigants brought before the courts for adjudication by regular proceedings established for the protection or enforcement of rights, or the prevention, redress, or punishment of wrongs. Whenever the claim or contention of a party takes such a form that the judicial power is capable of acting upon it, then it has become a case or controversy."

The case of *Traction Company v. Mining Company*, supra, was identical in principle with the case at bar. Mr. Justice Harlan, delivering the opinion of the court, commencing at page 245 of 196 U. S., page 253 of 25 Sup. Ct. (49 L. Ed. 462), said:

"The rule is now settled that, under the judiciary act of 1887-1888, a suit cannot be removed from a state court unless it could have been brought originally in the Circuit Court of the United States. *Tennessee v. Union & Planters' Bank*, 152 U. S. 454, 14 Sup. Ct. 634, 38 L. Ed. 511; *Mexican Nat. R. R. v. Davidson*, 157 U. S. 201, 15 Sup. Ct. 563, 39 L. Ed. 672; *Metcalf v. Watertown*, 128 U. S. 586, 9 Sup. Ct. 173, 32 L. Ed. 543; *Minnesota v. Northern Securities Co.*, 194 U. S. 48, 24 Sup. Ct. 598, 48 L. Ed. 870.

"Why could not the proceeding instituted in the county court have been brought originally in the federal court? The case, as made in the county court, was, beyond question, a judicial proceeding; it related to property rights, the parties are corporate citizens of different states, and the value of the matter in dispute exceeded the amount requisite to give jurisdiction to the Circuit Court. It was therefore a proceeding embraced by the very words of the Constitution of the United States, which declares that the 'judicial power shall extend * * * to controversies * * * between citizens of different states,' as well as by act of 1887 (Act March 3, 1887, c. 373, 24 Stat. 552 [U. S. Comp. St. 1901, p. 508]), which declares 'that the Circuit Courts of the United States shall have original cognizance, concurrent with the courts of the several states, of all suits of a civil nature at common law or in equity, where the matter in dispute exceeds, exclusive of interest and costs, the sum or value of two thousand dollars, * * * in which there shall be

a controversy between citizens of different states.' In view of these explicit provisions, it is clear that the proceeding in the county court was a suit or controversy within the meaning both of the Constitution and of the judiciary act. We could not hold otherwise without overruling former decisions of this court."

In *Mason City R. R. Co. v. Boynton*, 204 U. S. 576, 27 Sup. Ct. 321, 51 L. Ed. 629, a condemnation case arising under the statutes of Iowa, Mr. Justice Holmes, delivering the opinion of the court, said:

"In condemnation proceedings the words 'plaintiff' and 'defendant' can be used only in an uncommon and liberal sense. The plaintiff complains of nothing. The defendant denies no past or threatened wrong. Both parties are actors; one to acquire title, the other to get as large pay as he can. It is not necessary, in order to decide that the present removal was right, to say that the state decision was wrong; we leave the latter question where we find it. But we are of opinion that the removal in this case was right for reasons which it will not take long to state."

In the light of the foregoing cases and many other decisions from the Supreme Court, I am clearly of the opinion that the condemnation proceeding involved in this suit is of such nature, involves such amount, and is such a controversy between a citizen of this state and a citizen of a foreign state that it was from the time of the institution of the proceeding, by the passage and presentation of the resolution of the common council to the judge of the state court, such a proceeding as is properly removable into this court, and was by the proceedings taken by complainant rightfully removed into this court.

From this it necessarily follows that the judge of the state court was without jurisdiction to make the appointment of the commissioners made in this case, and that this court in the protection of its jurisdiction will stay further proceedings on the part of such commissioners acting without authority. It follows, the temporary injunction applied for must issue. It is so ordered.

It is further ordered that unless the parties to this suit shall, within 20 days from this date, file a stipulation fixing the price at which the plant may be taken over by the city (if the electors by their vote shall so authorize); or in the event that solicitors for the respective parties to this litigation shall fail for 20 days to agree upon a commission to make an award herein, in such case commissioners will be named by this court to make an estimate and appraisal of the value of the property and the amount of the award which shall be paid by the city to complainant for the works. And in the event an award is made by such commission, and such award shall prove unsatisfactory to complainant herein, on demand it shall have a jury to estimate the value of the plant, and award compensation therefor to complainant. And in such event, if the same is ratified by a vote of the electors of the city, the purchase will be thus complete. If not ratified, the matter will stand in its present condition. All further proceedings herein will be taken in the case removed into this court, No. 8,715, on the law docket of this court. 164 Fed. 728.

THE JOSEPH P. TUCKER.

(District Court, E. D. Pennsylvania. November 6, 1908.)

No. 51.

WHARVES (§ 20*)—GROUNDING OF VESSEL—LIABILITY OF LESSEE OF WHARF.

Respondent leased the shoreward end of a wharf 300 feet long, on one side of which was a dock or slip 40 to 50 feet wide which he did not lease but used to bring vessels to his part of the wharf. There was sufficient water opposite his portion for vessels to lie safely, but toward the outer end of the dock a bar or shoal extended across it, the most of which was under water at all stages of the tide. Libellant's barge, laden with lumber a part of which was to be discharged at respondent's wharf, in charge of a master who had no knowledge of the locality, relying on the assurance of respondent's agent that there was sufficient water, attempted to enter the slip, and grounded on the shoal and was injured. *Held* that, while respondent was not responsible for the condition of the dock at the place of the shoal, it was his duty to see that vessels approaching his wharf therein were advised of such condition, and that under the facts shown he was liable for the injury.

[Ed. Note.—For other cases, see Wharves, Cent. Dig. §§ 35-37; Dec. Dig. § 20.*]

In Admiralty. Suit in personam for damages to barge.

George P. Rich, for libellant.

Francis S. Laws and Francis C. Adler, for respondent.

J. B. McPHERSON, District Judge. In August, 1906, the respondent (who is a dealer in lumber) was, and for several years previous had been, one of the lessees of Allison's Wharf, a wharf or pier on the west side of the Schuylkill river in the city of Philadelphia. The structure is 300 feet long, and runs from west to east, beginning at Thirtieth street and projecting into the river. The respondent leased 160 feet of the western end, the remaining 140 feet being occupied by another tenant. On the north side of the wharf, running along its whole length, was a dock or slip, 40 feet wide at Thirtieth street and 50 feet wide at the other end, another wharf bounding the dock on the north. The respondent's lease did not include the dock, but he was permitted to bring vessels into it in order that they might lie alongside his premises and discharge their cargoes in that position. The bottom of the dock was of soft mud, 4 or 5 feet deep, in which all vessels discharging at respondent's wharf were obliged to lie, except at high tide, but where they could lie in safety after they reached his premises. Toward the easterly end of the dock, however, stretching from the part of the wharf that was leased to the other tenant completely across to the wharf on the north side, was an obstructing bar or shoal, which was probably 3 feet wide from east to west at Allison's Wharf and increased in width as it approached the north side of the dock. It was of the same material as the rest of the bottom—soft mud—and it was somewhat higher on the north side of the dock than upon the south side. Its height varied, being from 6 to 8 inches. On the north side of the dock it was exposed at dead low tide for

*For other cases see same topic & § NUMBER in Dec. & Am. Digs. 1907 to date, & Rep'r Indexes

about 15 feet, but the rest of it was covered at the same stage by a foot and a half or 2 feet of water, and was therefore not visible. The tide ordinarily rises 6 feet in the dock, so that the depth of water at high tide over the shoal for, say, 20 or 25 feet north from Allison's Wharf, was from $7\frac{1}{2}$ to 8 feet. The height of the tide, however, varies with the wind; with an east or northeast wind the depth over the shoal is usually greater, while with a west or southwest wind the depth is usually less, than these measurements. As the shoal or bar lay between the river and respondent's part of the wharf, a vessel was obliged to cross it before she could reach a berth alongside his premises. If she was able to cross, safety was attained; but, if she grounded upon the shoal and could not be promptly pulled off, she was in a dangerous position, because the water deepens rapidly from the shoal eastward, and, as the eastern part of the vessel would thus be without other support than the water, she would be likely, especially if she were loaded, to break or be severely strained.

Under such circumstances, what duty did the respondent owe to vessels that were bound to his wharf upon his invitation? He had no control over the dock, except such as might be involved in the permission to use it, and he certainly was under no obligation to dredge away the shoal. But, knowing as he did that the shoal existed, and knowing also its situation, its approximate dimensions, and its characteristics, he was bound to communicate his knowledge to incoming vessels, so that they might take appropriate precautions against the danger. If he failed to give such notice, or if he gave misleading information, whereby in either case a vessel proceeding in ignorance was induced to attempt the passage under dangerous conditions, he would be liable for such injuries as might be sustained. On the other hand, if he duly informed the vessel of the threatening situation, or if the master knew about it from any other source, but in the face of such notice or knowledge the vessel nevertheless went on and took the risk of a successful crossing, without encouragement or direction from the respondent, the venture would not be his, but would be the vessel's only. I do not understand these rules to be questioned, and it only remains to apply them to the facts disclosed by the testimony.

These facts are as follows: The libellant's barge, the Joseph P. Tucker, loaded with a cargo of lumber, of which part was consigned to the respondent, arrived at the river end of Allison's Wharf on the evening of August 26th. The master of the barge had never been at the wharf before, and knew nothing about the dock or the shoal. The berth alongside the respondent's premises was occupied by another barge, which was then in process of unloading, and the Tucker was obliged to lie at the end of the wharf until the following Thursday morning. During these three days the master was about the wharf for much of the time, and observed so much of the conditions in the dock as were visible at different stages of the tide. He saw the exposed northern part of the shoal at low water, but of course he could not know by mere inspection how deep the water was at that stage of the tide upon the covered southern part. With commendable caution he took soundings from the north side of the wharf, and found suffi-

cient water, both east and west of the shoal, to permit the safe passage of his barge. But, as it happened, there was a large pile of lumber on the wharf, extending to its cap-log, and this pile was directly opposite the shoal, so as to prevent sounding at that point from the wharf, and the consequence was that no sounding was made upon the shoal itself. It is argued that the master should have used a boat when he found that his access to the dock from the wharf was obstructed at this point by the pile of lumber, and that he was negligent in failing to employ this means. I do not agree with this contention; such use of a boat would have been out of the ordinary, and there was nothing, I think, to suggest that so unusual a precaution should be adopted. Certainly there was the less occasion to suspect that unusual care should be taken, if it be true, as I think it is, that the respondent's son—who was his responsible agent in charge of the wharf, and had full knowledge concerning the dock and the shoal—assured the master that there was sufficient water in the dock to permit the barge to go safely to her berth alongside the respondent's premises. The Tucker, which was a large vessel, 168 feet long, was drawing 8 feet aft and 6 feet 7 inches forward, and the respondent's agent was advised of this draft. There is much dispute concerning the information which he gave to the master; it would be profitless to repeat the details of the testimony; but I think the weight of the evidence establishes the fact that he did assure the master that there was sufficient water in the dock to take the Tucker safely to her berth at flood tide. Probably in order to make sure on this point, the respondent's agent decided to unload part of the cargo at the eastern end of the wharf before taking the barge across the shoal. On Thursday, August 30th, therefore, some of the lumber was unloaded at the end of the wharf and hauled to the respondent's premises. After this work had gone on for two hours, the barge that had previously been discharging drew out of the dock, leaving the berth empty. There was a small schooner close by, which was also destined for the dock, and the respondent's agent was anxious that she should not get in ahead of the Tucker. Accordingly he urged the master to hurry, helped him by sending on board of the barge several of his own men, and took part in aiding the movement of the vessel along the north side of the wharf toward the respondent's premises. The unloading that morning had been from the bow, so that while the bow was higher the stern was about 2 inches deeper, and the result of the effort to enter was that the barge stuck fast on the shoal, taking the ground about 95 feet from the stern. At this time the tide was almost, if not quite, flood, but as the wind was unfavorable the rise was probably several inches less than usual. Attempts were immediately made to pull her off, but they were unavailing, as the water speedily began to go down. Efforts to obtain a tug were also fruitless, and it was necessary to leave the vessel where she was until the cargo destined for the respondent was taken off. This required three days, and meanwhile injury was done by the "hogging" to which she was subjected.

The negligence of the respondent's agent seems to me to be clear. He was apparently anxious to save the time and money which would

be expended in lightening the barge to a draft that would be perfectly safe, and hoped that she could be forced through the mud of the shoal for the few feet that offered the chief, if not the only, obstacle to her progress toward a place of safety. Actuated by this motive, he gave information to the master that was slightly, but sufficiently, misleading, and took the risk that the effort to force the boat through would be successful. For his negligence the respondent is liable. I see no negligence on the part of the master. The respondent's theory is that the master had ample notice about the shoal from several sources, and that he and his stevedore took the chance of getting through, moving the barge into the dock during the temporary absence of the respondent's agent, and without his knowledge or approval. In my opinion, this theory has not been established by the evidence, and therefore should not be allowed to influence the decision.

A decree may be entered in favor of the libellant, with costs and a reference to a commissioner.

In re RUOS.

(District Court, E. D. Pennsylvania. October 2, 1908.)

No. 1,093.

1. BANKRUPTCY (§ 224*)—SPECIAL REFEREE—POWERS.

The powers of a special referee, appointed on petition of a receiver for the property of an alleged bankrupt pending a hearing on the petition, with authority to examine the bankrupt and other witnesses in relation to the property and assets of the bankrupt generally, were superseded on the making of an adjudication and an order of general reference.

[Ed. Note.—For other cases, see Bankruptcy, Dec. Dig. § 224.*]

2. BANKRUPTCY (§ 136*)—ORDER REQUIRING BANKRUPT TO TURN OVER PROPERTY—PROCEDURE TO OBTAIN.

An order requiring a bankrupt to turn over money or property to his trustee should be made only after a hearing on a petition therefor, making definite averments on the subject and offering a definite issue, upon which both parties may adduce evidence.

[Ed. Note.—For other cases, see Bankruptcy, Dec. Dig. § 136.*]

3. BANKRUPTCY (§ 136*)—ABILITY OF BANKRUPT TO COMPLY.

A finding by a referee that at the time of his bankruptcy a bankrupt had in his possession or under his control money or property of his estate, which he withheld from his trustee, does not warrant an order, seven years afterward, requiring him to turn the same over to his trustee; it not being shown that he is then able to comply with such order.

[Ed. Note.—For other cases, see Bankruptcy, Dec. Dig. § 136.*]

In Bankruptcy. On reports of special referees, and on motion for an order requiring bankrupt to pay money to trustee.

See, also, 159 Fed. 252.

John C. Swartley and William Stuckert, for trustee.

Francis Shunk Brown and Webster Grim, for bankrupt.

J. B. McPHERSON, District Judge. Unfortunately the true nature of this proceeding seems not to have been clearly realized, with

*For other cases see same topic & § NUMBER in Dec. & Am. Digs. 1907 to date, & Rep'r Indexes

the result that much time and trouble have been expended in what the court must now declare to be a fruitless effort. When the creditors' petition was filed on September 10, 1901, and amended on September 24th, it averred as the acts of bankruptcy certain fraudulent transfers and concealment of property and a permitted preference through legal proceedings. These averments were denied by the bankrupt in an answer filed on October 3d, but meanwhile, on September 13th, a receiver was appointed to take charge of the bankrupt's property and books of account, and to hold them until further order. On September 23d the receiver presented a petition averring that the bankrupt had recently collected large sums of money for which he had failed to account, and that he had improperly disposed of much of his property. The petitioner stated upon information and belief that the bankrupt had dissipated and used most of his assets, declared that the disposition of these assets could only be ascertained by an immediate examination of the bankrupt, and prayed the court to appoint a special referee to take the testimony of the bankrupt and of other witnesses, in order to discover the whereabouts of the assets. The prayer was granted, and on the same day a special referee was appointed. This action was evidently taken under clause 9 of section 7 (Bankr. Act July 1, 1898, c. 541, 30 Stat. 548 [U. S. Comp. St. 1901, p. 3425]), which requires a bankrupt, when present at the first meeting of his creditors, "and at such other times as the court shall order," to submit to an examination, *inter alia*, concerning the amount, kind, and whereabouts of his property. The special referee held a meeting on October 3d, at which the examination of the bankrupt was begun. On this day, also, the answer was filed, denying the material averments of the creditors' petition, and apparently a somewhat prolonged controversy was threatened. On October 9th, however, before the second meeting was held, the bankrupt filed a supplemental answer to the creditors' petition, in which he admitted his insolvency and declared his willingness to be adjudged a bankrupt. This was followed by an immediate adjudication and an order of general reference. By this unexpected turn of affairs the special reference was clearly superseded. It was undoubtedly justified on September 23d, when it was evidently not known that the bankrupt would shortly consent to an adjudication; but when this consent was given by the supplemental answer, and the adjudication followed in due course, there was no longer any occasion for a special examination. The whole inquiry was thereupon committed by the statute to the general referee, before whom the bankrupt was bound to appear and to submit to the same examination as was contemplated by the order of September 23d. The only reason for the special reference was the apparent need for an immediate inquiry, which would not then be had in the ordinary course of procedure, since no adjudication had been entered, or apparently was likely to be entered during an uncertain period.

Instead of abandoning the special reference, however, the referee and the parties interested went on with it for 12 or 15 months, taking a mass of testimony, and adding to the confusion by proceeding at the same time with the statutory examination of the bankrupt under the

order of general reference. No one, however, seems to have objected, and the controversy was carried on in a leisurely fashion until June, 1904, when the special referee prepared a report in that capacity, finding that the bankrupt had in his possession, or within his control, "property to the value of at least \$4,000 and cash to the amount of at least \$10,000, which he should have transferred to the receiver and trustee of his estate" (the receiver having been duly elected as trustee), and recommending that the court order the bankrupt to pay the cash and deliver the property, or pay its value, to the trustee of his estate. He also reported certain facts concerning a transaction between the bankrupt and his brother Joseph, concluding that Joseph had received a preference of more than \$11,000, with reasonable cause to believe that a preference had been intended. Exceptions to this report on behalf of the bankrupt and his brother were overruled by the referee on May 24, 1905, and on the following day the report was filed in the office of the clerk. Nothing further seems to have been done until February 20, 1907, when the bankrupt presented a petition to the court, asking that the matter should be re-referred in order that additional testimony might be taken, averring that no part of the property or cash embraced in the recommendation of the report was in his possession or control at the time of the filing of the petition in bankruptcy, or had been since, and praying that the order of re-reference might not direct the referee to make or recommend any order to turn over assets to the trustee. On the same day the court directed this further inquiry to be made, and (evidently overlooking the fact that a regular referee was now in charge of the estate) appointed another special referee to ascertain and report the facts, with the testimony and his findings thereon. This has been done, but the second report does not essentially change the situation as presented by the first referee.

Upon this record the court is asked to make the order recommended by the first report, directing the bankrupt to deliver certain property, or pay its value, and to pay certain cash to his trustee. Clearly, as I think, no such action should be taken. The receiver's petition of September 23d, which is the foundation of the whole proceeding, does not contemplate such an order, but simply asks for a general inquiry concerning the whereabouts of the bankrupt estate. If it had appeared in the course of this inquiry that the bankrupt probably controlled or was possessed of money or property that rightfully belonged to his estate, the correct proceeding to compel delivery would have been begun by presenting a petition making definite averments upon this subject and offering a definite issue. To such a petition the bankrupt would have been entitled to reply, and upon the issue raised by his answer both parties would have had the right to offer evidence, not only that which had been already taken, but such further evidence as might be relevant. The facts would thus appear, and the proper order would have the necessary support. Here, however, there was neither an appropriate petition nor an answer thereto, and therefore no issue to which the evidence can be definitely applied. On such a record I must decline to make an order that might be followed by the imprisonment

of the bankrupt. As was said in *Boyd v. Glucklich*, 116 Fed., at page 134, 53 C. C. A., at page 454, concerning an analogous situation:

"Dispatch in judicial proceedings is commendable; but in proceedings involving the liberty of a citizen he has a right, not only to be informed of the precise claim against him, but, after receiving that information, he has a right to a reasonable time to prepare his answer and present his proofs, and, lastly, to be heard by counsel on the law and facts of the case. While proceedings in bankruptcy may be summary, they should not be too summary; in other words, they should not be so summary as to deprive the bankrupt of those fundamental rights and privileges that belong to every citizen, among which are the right to be advised of the demand made upon him, and the right, after being so advised, to have a reasonable time to prepare his defense and produce his witnesses. The bankrupt act does not do away with these rights, and no citizen forfeits them by being adjudged a bankrupt. The bankrupt act contemplates that proceedings in bankruptcy shall go forward with all reasonable dispatch compatible with the due and orderly administration of justice and a proper regard for the fundamental rights of the citizen."

So, also, in *Re De Gottardi* (D. C.) 114 Fed. 332, numerous authorities are collected in support of the proposition that a bankruptcy court has jurisdiction, "on issues properly joined," to determine whether or not a bankrupt has in his possession or under his control money or other property belonging to his estate in bankruptcy, and, "if the issues be found against the bankrupt," to make an order requiring him to pay or deliver to the trustee, etc.

Moreover (whatever may have been the fact seven years ago, when these proceedings were begun), I am by no means satisfied that the bankrupt has now in his possession, or under his control, the money and property referred to in the reports of the special referees, and that he could comply with an order to deliver to his trustee. In such a situation, the duty of a District Court is thus declared by Judge Gray, speaking for the Court of Appeals of this circuit in *American Trust Co. v. Wallis*, 126 Fed. 466, 61 C. C. A. 344:

"The powers vested in courts of bankruptcy to accomplish the general purposes of the bankrupt law, to wit, to segregate the estate of the bankrupt and provide for its equitable distribution amongst the creditors, are plenary and far-reaching. The court may, by summary order, direct the delivery and turning over to the trustee by the bankrupt, or by any third person holding the same by his order and control, any property which, prior to the filing of the petition, the bankrupt could by any means have transferred, or which might have been levied upon and sold under judicial process against him. For disobedience of such an order the court in bankruptcy undoubtedly has the power, by attachment for contempt, to enforce compliance with such order, and punish refusal to comply. This power, however, is far-reaching and drastic, and must be exercised with cautious discretion. If the bankrupt denies that he has possession or control of the property, or, if a third person in possession thereof claim to hold it, not as the agent or representative of the bankrupt, but by title adverse to him, and there is no evidence to indisputably show that such denial or claim is false or fraudulent, and that the case is one of simple concealment or refusal on the part of the bankrupt, or the one in possession, to deliver up the property as ordered, it would be an unwarranted stretch of power on the part of the court to resort to a summary proceeding for contempt for the enforcement of its order. In the absence of fraud or concealment, the bankrupt court can only order the delivery of property to the trustee which the bankrupt is physically able to deliver up, having the same in his possession or control. If it shall appear that he is not physically able to deliver the property required by the order, then, confessedly, proceedings for contempt, by fine and imprisonment, would result in nothing, certainly not

in compliance with the order. The contempt in this case could only be purged by a reiteration of the physical impossibility to comply with the order whose disobedience is being thus punished. An order made under such circumstances would be as absurd as it is inconsistent with the principles of individual liberty."

The motion to direct the bankrupt to deliver and pay must be refused.

BOWLING GREEN TRUST CO. v. VIRGINIA PASSENGER & POWER
CO. et al.

(Circuit Court, E. D. Virginia. October 13, 1908.)

1. RAILROADS (§ 190*)—SUIT TO FORECLOSE MORTGAGES—REORGANIZATION PLAN.

In consolidated suits to foreclose various liens upon railroad property, upon the question of ordering a sale of the property in advance of a determination of the rights of the several parties and the right of bondholders to intervene, a plan of reorganization, proposed by certain of the bondholders, may properly be considered.

[Ed. Note.—For other cases, see Railroads, Dec. Dig. § 190.*]

2. CORPORATIONS (§ 482*)—MORTGAGES—FORECLOSURE—INTERVENTION.

Mortgage bondholders have no right to intervene in a suit by the trustee to foreclose the mortgage, unless negligence, incompetency or improper conduct of the trustee, injuriously affecting their interests, is established; but the failure of the trustee to join in contesting the validity or amount of a prior mortgage, where there is a bona fide contest of the same by other parties in interest, is a sufficient ground for permitting the bondholders to intervene and make such contest.

[Ed. Note.—For other cases, see Corporations, Dec. Dig. § 482.*]

3. RAILROADS (§ 192*)—FORECLOSURE OF MORTGAGE—SALE OF PROPERTY—DISCRETION OF COURT.

In a suit to foreclose various liens on railroad property, it is within the discretion of the court to order a sale of the property in advance of settling the respective rights and priorities of the parties, and such discretion should be exercised, where it appears undesirable to continue the operation of the property by receivers, and by proper reservations in the decree of sale the rights of all parties can be protected.

[Ed. Note.—For other cases, see Railroads, Dec. Dig. § 192.*]

In Equity.

See, also, 132 Fed. 921; 133 Fed. 186.

Under the above style, five suits in equity are pending in this court, entitled briefly: (1) Bowling Green Trust Company, Trustee, v. Virginia Passenger & Power Company, Richmond Passenger & Power Company, and Richmond Traction Company. (2) Central Trust Company of New York v. Richmond Passenger & Power Company, Bowling Green Trust Company, et al. (3) Metropolitan Trust Company of New York, Trustee, v. Richmond Passenger & Power Company, Bowling Green Trust Company, et al. (4) Equitable Trust Company of New York v. Virginia Passenger & Power Company, Bowling Green Trust Company, et al. (5) John A. Roebling's Sons Company v. Virginia Passenger & Power Company, Richmond Passenger & Power Company, Richmond Traction Company, and the complainant trustees in the first four suits. The litigation involves the property of the street railway companies and power and electric plants in the cities of Richmond, Manchester, and Petersburg, and the adjoining counties of Henrico, Chesterfield, and Dinwiddie. The purposes of the four first mentioned suits, generally,

*For other cases see same topic & § NUMBER in Dec. & Am. Digs. 1907 to date, & Rep'r Indexes
164 F.—48

are to foreclose the mortgages to the complainant trustees, respectively—the suit by the Bowling Green Trust Company against the Virginia Passenger & Power Company being to foreclose the consolidated mortgage given by said Virginia Passenger & Power Company upon the property in question, the latter company having acquired all of said property and the property of the constituent companies, subject to certain underlying incumbrances thereon, and given to said Bowling Green Trust Company the general or blanket mortgage sought to be foreclosed; the suit of the Central Trust Company of New York being to foreclose against the Richmond Passenger & Power Company one of the underlying mortgages aforesaid upon the property of the Richmond Passenger & Power Company; the suit of the Metropolitan Trust Company, trustee, being, among other things, to foreclose an underlying mortgage, also given by said Richmond Passenger & Power Company, subject to the lien of the Central Trust Company's mortgage; the suit of the Equitable Trust Company being to foreclose an underlying mortgage given by the Southside Railway & Development Company; and the suit of John A. Roebling's Sons Company against the Virginia Passenger & Power Company, being a general creditors' bill against said Virginia Passenger & Power Company and all of the constituent companies and the trustee aforesaid in said several mortgage deeds, and others, to subject generally all the property and estate of the Virginia Passenger & Power Company to the payment of its debts.

After the maturity of said several causes, the same were duly consolidated under the style of "Bowling Green Trust Company, Trustee, v. Virginia Passenger & Power Company and Others," and by decree entered in said combined cause on the 10th of March, 1905, were referred to Special Master Addison L. Holladay to take generally an account of the property and assets of the several companies, respectively, the liens thereon, and their order and priority, with directions to report as in said order set forth; and the special master was authorized to make separate reports from time to time. On the 16th of April, 1908, the master filed in the consolidated cause a separate report, purporting to show the property, real and personal, assets, and franchises of the Richmond Passenger & Power Company, and the liens thereon, and their priorities. On the 27th of June, 1908, he filed in said consolidated cause another separate report, purporting to show the property, real, and personal, assets, and franchises of the Southside Railway & Development Company, the Virginia Internal Improvement Company, the Virginia Electrical Railway & Development Company, the Westhampton Park Railway Company, the Virginia Passenger & Power Company, and the Richmond Traction Company, and the liens and priorities thereof. On the 24th day of July, 1908, the special master filed another report in said consolidated cause on the subject of the "alleged diversion of good will, customers, and property from the Richmond Passenger & Power Company to the Virginia Passenger & Power Company." To these several reports numerous exceptions have been filed, and the cause is now before the court upon the several applications of the Bowling Green Trust Company, the Central Trust Company, and the Equitable Trust Company of New York for decrees of foreclosure and sale in said consolidated cause, and each of the several causes, in which said respective applicants are complainants, in advance of the court's passing upon the exceptions so taken to the several reports of the master.

The Metropolitan Trust Company, trustee, earnestly opposes the sale asked for at this time, and in advance of the determination of the questions raised upon the exceptions to the reports aforesaid, and especially to the court's decreeing sale (a) in advance of determining the validity of the Metropolitan Trust Company's mortgage and the amount due thereon; (b) in advance of determining the question of the validity of a certain mortgage, and the amount due thereon, known as the "Richmond & Manchester mortgage," upon the property of the Richmond Passenger & Power Company, ahead of the mortgage of the Central Trust Company, and hence prior to the Metropolitan Trust Company's mortgage; (c) in advance of determining what diversions, if any, have been made of the property of the Richmond Passenger & Power Company properly subject to its mortgage, by the Virginia Passenger & Power Company; (d) in advance of determining the validity of the deed of 23d of January, 1902, from the Richmond Passenger & Power Company to

the Virginia Passenger & Power Company, and the agreement of the last-named company, in consideration of such conveyance, to pay the debenture bonds secured in the Metropolitan Trust Company mortgage.

Upon the hearing of this application for a decree of sale, and the objections of the Metropolitan Trust Company thereto, Frank E. Howe and others, claiming to hold bonds to the amount of \$102,000, part of the issue of January 1, 1900, of \$3,000,000 bonds by the Richmond Passenger & Power Company, secured under its mortgage to the Central Trust Company, dated April 13, 1900, and sought to be foreclosed, asked leave to file their petition to be heard in their own behalf, because of the failure of the trustee, among other things, to represent them properly on the question of the validity of the Richmond & Manchester bonds, aforesaid, and as to whether there had been any diversion of property subject to the mortgage under which they were secured. With this petition was filed an alleged plan of reorganization of the properties, in which it appears that the bondholders generally under their mortgage propose to join, and in which the contested indebtedness under the Richmond & Manchester mortgage is treated as a valid lien. The Metropolitan Trust Company likewise tendered to the court one of the alleged plans of reorganization, with affidavit attached.

To the right of Howe and others to intervene as individual bondholders, the Central Trust Company, trustee, excepted, as did the Bowling Green Trust Company, and each company tendered certain affidavits explanatory of the action of the different trust companies and of said plan of reorganization, and likewise excepted to the right of the court to take notice of such plan of reorganization.

Munford, Hunton, Williams & Anderson, for Bowling Green Trust Co. and John A. Roebling's Sons Co.

Joline, Larkin & Rathbone and Leake & Carter, for Central Trust Co.

Davis & Davis, L. L. Lewis, and Byrne & Cutcheon, for Metropolitan Trust Co.

Coke & Pickrel, for Equitable Trust Co. of New York.

WADDILL, District Judge (after stating the facts as above). The preliminary questions presented are (1) as to the right of the bondholders under the Richmond mortgage to the Central Trust Company to appear in their own behalf, and (2) whether the reorganization plan referred to can be considered. The ground on which it is claimed the reorganization should be taken into account is not for any merit or disadvantage there may be in it, or the right of any party to join therein, but merely as to its effect upon the rights of parties in interest, as bearing upon the question of whether the court at this time should exercise its discretion to make sale of the property. For this purpose the plan of reorganization may be considered, as well as its relevancy to the charge made by the intervening bondholders against their trustee, and accordingly the same may be filed, as requested by the intervening bondholders. With the fairness and equity of the plan we have nothing to do. The persons joining therein manifestly have the right to do so, and the court, certainly upon the present pleadings, is without authority or jurisdiction to control them in their undertakings in that regard, or to say what may be the outcome of the same. The case of *Farmers' Loan & Trust Co. v. Toledo, etc., R. Co.*, 67 Fed. 53, a decision of the Circuit Court for the Northern District of Ohio, by Judge Taft, seems to be express authority on this subject.

Just when and when not individual bondholders shall be allowed to intervene and be heard in their own behalf, is well settled under fed-

eral authorities, and certainly in the courts in this circuit. They have no such right, unless it is averred and shown that their trustee has been derelict in the discharge of his duty to them. His negligence, incompetency, or improper conduct in and about the particular transaction must be established. The cases in this circuit especially bearing on this subject are *Skiddy v. A., M. & O. R. R.*, Fed. Cas. No. 12,922, 22 Fed. Cas. 274,286, *Clyde v. R. & D. R. R. Co.* (C. C.) 55 Fed. 445, and *Bowling Green Trust Co. v. Virginia Passenger & Power Co.* (C. C.) 132 Fed. 921; and the decisions of the Supreme Court of the United States are *Shaw v. Railroad*, 100 U. S. 605, 25 L. Ed. 757, and *Richter v. Jerome*, 123 U. S. 233, 246, 8 Sup. Ct. 106, 31 L. Ed. 132.

The averments of the petition of intervention in this case relate more particularly to what may be termed the negligence of the trustee. They are to the effect that in this litigation, in which it is claimed that all but five of the 400 bonds of \$1,000 each embraced in what is known as the "Manchester mortgage," which comes immediately ahead of the mortgage securing the bonds held by the petitioners, have been paid off and extinguished, and no longer constitute as to them a paramount lien on the property. This question has been fully investigated before the master, and he has reported adversely to the claim that said bonds have been paid, which now amount to some \$570,000 and constitute a lien upon the property. This report is excepted to by the junior lienor, the Metropolitan Trust Company, and is one of the hotly contested issues in the case. The trustee in the mortgage under which petitioner claims has not joined in these exceptions, further than to raise the technical question that the validity of the mortgage and the bonds secured thereunder is not involved in the Central Trust Company suit, and that the proper parties to litigate that subject are not before the court, although the rulings of the court and of the special master in the combined causes and under the general order of reference are to the contrary of his view. It is further charged that said trustee has failed to join in the contest as to the property alleged to have been diverted from the lien of the mortgage.

These alleged omissions of the trustee relate to something pertaining to this litigation, of which the court has knowledge, and must take judicial notice of. While there are many things the trustee should exercise a broad discretion about, and be largely influenced, if not governed, by the directions of an overwhelming majority of those secured under the mortgage, still it may be seriously doubted whether he should be permitted to deprive the bondholders of the right of contesting the validity of a prior mortgage to the one in which they are secured, as well as the amount due thereunder, if they desire to do so, and the trustee elects to act to the contrary. In *Farmers' Loan & Trust Co. v. Toledo, etc., R. Co.* (C. C.) 67 Fed. 53, in discussing the question of whether or not stockholders should be admitted to interpose and in the name of the company contest the validity of bonds due under the mortgage on the company's property, Judge Taft, speaking for the court, said:

"The refusal of the board of directors to make a valid and equitable defense to the foreclosure of the mortgage, and to the sale of all the properties and franchises belonging to the road, when the existence of such defenses is

brought to their knowledge, would of itself constitute such gross neglect or fraud on their part as to require the court to permit their interested cestuis que trustent, the stockholders, to make the defense themselves"—citing *Dodge v. Woolsey*, 18 How. 331, 15 L. Ed. 401.

The principle stated seems to apply to the action of the trustee, where there appears to be a bona fide contest over the prior mortgage, as here, certainly to the extent that the court should allow the bondholders to come in, make defense themselves, or require the particular or some substituted trustee to do so. In *Skiddy v. A., M. & O. R. R.*, Fed. Cas. No. 12,922, 22 Fed. Cas. 274,286, it is said:

"It is nowhere alleged in this petition, original or amended, that the trustees or their counsel, so far as this suit has progressed, have not acted for the benefit of all the bondholders under the mortgage, without partiality or prejudice. No single act of the trustee in the conduct of the suit is referred to as detrimental to or in antagonism of the interest of the petitioners."

And in *Bowling Green Trust Co. v. Virginia Passenger & Power Co* (C. C.) 132 Fed. 925, it is said, referring to the bondholders:

"They will have the right to * * * bring to the attention of the court any misconduct or dereliction of duty on the part of the complainant trustee, or others connected with the litigation or management of the property under the court's control; and this may be carried to the extent of the removal of an improper, incompetent, or derelict trustee, and the substitution of others in his stead. But none of these things should be done, unless charges of unfaithfulness be specifically made and established, or unsuitableness clearly shown."

In the view taken by the court, it sufficiently appears that the Central Trust Company, trustee, is not now contesting, and does not in the future purpose to controvert, the matters referred to by the petitioning bondholders; and said bondholders, if they desire so to do, and at their own expense, should be allowed to intervene to protect their interests, particularly in view of the fact that the court is asked by the trustee to decree a sale of the entire subject-matter in advance of the ascertainment of the liens and settlement of the rights of the parties. After the foreclosure, unless by proper reservations at this time, it will be too late for these bondholders to make, or join with others in making, the contest they wish to respecting the amount due under the prior mortgage, or the alleged diversion of property subject to the lien of the mortgage under which the bonds are secured.

Considering the application for sale of the property in advance of the determination of the liens and ascertainment of the priorities thereof, presented by the exceptions to the master's report, it may be said that this motion is one addressed to the sound discretion of the court, and in the exercise of which the court should be influenced and controlled in its action by what is fair and right to be done, having regard to the subject-matter of the litigation and to the rights of all parties in interest. That the court can decree a sale at this time in advance of settling any, if not all, of the questions involved in the various exceptions, seems clearly to be within the legal discretion of the court. *Bank v. Shedd*, 121 U. S. 74, 7 Sup. Ct. 807, 30 L. Ed. 877; *Mellen v. Iron Works*, 131 U. S. 352, 369, 9 Sup. Ct. 781, 33 L. Ed. 178; *Wabash R. R. v. Adelbert College*, 208 U. S. 382, 28 Sup. Ct. 182, 52 L. Ed. 379; *Bound v. S. C. R. R.* (C. C.) 50 Fed. 853; *Compton v. Jesup*,

68 Fed. 263, 289, 313, 15 C. C. A. 397; Alabama Mfg. Co. v. Robinson, 72 Fed. 708, 19 C. C. A. 152; Low v. Blackford, 87 Fed. 392, 31 C. C. A. 15; Toledo R. R. v. Continental Trust Co., 95 Fed. 497, 36 C. C. A. 155.

In the exercise of its discretion, however, the court should as far as possible, by proper reservation in any decree of sale, preserve and protect the rights of the parties for future consideration. Viewing this application in this light, the objections most strongly pressed why the sale should not now be decreed will be considered. Those relating to the ascertainment of whether there has been any diversion of the property, or not, from the Richmond Passenger & Power Company to the Virginia Passenger & Power Company, and the validity of the undertaking on the part of the Virginia Passenger & Power Company to pay the debenture bonds secured in the Metropolitan Trust Company's mortgage, under the deed of the 23d of January, 1902, can undoubtedly be determined as well after as before a sale of the property. The sale of the property without settling the amount of indebtedness due under the Richmond & Manchester mortgage, the lien prior to that of the mortgage of the Central Trust Company, sought to be foreclosed, presents a greater complication, but in no respect an insuperable barrier to an immediate sale, especially as it is proposed to sell subject to the right hereafter to foreclose that mortgage. The property could doubtless be sold free and clear of the lien of that mortgage, leaving to the parties litigant the right to contest their rights against the fund arising from the proceeds of sale. But, since it is suggested that technically the trustee in the Manchester mortgage has not formally been brought into court, the better plan is perhaps to sell subject to said mortgage, and in that event the junior lienors would not be required to redeem as to the debt secured in the mortgage, and any purchaser could take into account the fact that there existed a dispute as to this liability against the property.

The sale of the property of the Richmond Passenger & Power Company in advance of ascertaining the amount due under the Metropolitan Trust Company mortgage, and determining the validity of said mortgage, can doubtless be made. But whether it ought to be is a different question, and upon the whole case the conclusion of the court is that these questions respecting this particular mortgage, to the end that those interested therein may know whether they have anything to redeem for and the amount thereof, ought to be settled in advance of a sale of the property. *Chicago, etc., v. Fosdick*, 106 U. S. 47-71, 1 Sup. Ct. 10, 27 L. Ed. 47; *Railroad Co. v. Swasey*, 23 Wall. 405, 23 L. Ed. 136; *Parsons v. Robinson*, 122 U. S. 112, 7 Sup. Ct. 1153, 30 L. Ed. 1122; *Morgan v. Railroad Co.*, 137 U. S. 193, 11 Sup. Ct. 61, 34 L. Ed. 625. This being done, and the amount of the Central Trust Company mortgage ascertained, as to which there is really no dispute, and that of the small prior lien upon which there is a balance of \$123,000 admitted by all parties, the Metropolitan Trust Company would know what had to be paid in order to redeem the property, and the sale could thus be had with little or no delay.

In reaching this conclusion that the property ought now to be sold, the court is not unmindful of the many objections there are to a sale

in advance of the ascertainment and settlement of the parties' rights; but these are outweighed by other considerations, which should control. The litigation has already been quite extended, and the improbability of an early settlement is manifest to all. The property is of a public nature, and of the kind that ought not to be kept longer than necessary under the control of the court. The receivership has been a most successful one, so far as the upbuilding, maintenance, and operation of the property is concerned. Yet it has been impossible to keep up the interest on the entire indebtedness secured and at the same time make desired improvements and comply with demands for increased and extended service, made necessary by the rapidly increasing growth of the several communities through which the various lines are operated. While large sums have been expended in the payment of interest on the underlying mortgages, on those sought to be foreclosed but little has been paid, and those speaking for parties most largely interested are urgently pressing for a sale, to the end that the property may be bought in by them, or sold to others and they awarded what is due to them.

Believing that the reasons presented are sufficiently cogent and urgent to call for the sale of the property at the earliest practicable moment, the same will be ordered as herein indicated.

JACKSON LUMBER CO. v. McCRIMMON, Tax Collector.

(Circuit Court, N. D. Florida. October 26, 1908.)

1. CONSTITUTIONAL LAW (§ 284*)—DUE PROCESS OF LAW—ASSESSMENT OF TAXES—NOTICE TO PROPERTY OWNER.

While notice to a property owner and an opportunity to be heard at some time during the proceedings is a fundamental requisite to the validity of an assessment for taxation, a statute is not invalid as depriving an owner of his property without due process of law, where it provides for general notice by publication, and fixes definite days for hearings.

[Ed. Note.—For other cases, see Constitutional Law, Cent. Dig. §§ 893, 894; Dec. Dig. § 284.*

Limitations of taxing power, see note to *Grether v. Wright*, 23 C. C. A. 515.]

2. TAXATION (§ 4*)—POWERS OF LEGISLATURE—TAXING PROPERTY FOR PREVIOUS YEARS.

It is within the power of the Legislature of a state to provide for the assessment and taxation for past years of property which has escaped taxation for such years.

[Ed. Note.—For other cases, see Taxation, Dec. Dig. § 4.*]

3. TAXATION (§ 309*)—CONSTRUCTION OF STATUTE—"ASSESSMENT."

The word "assessment," as used in tax statutes, does not mean merely the valuation of the property for taxation, but includes the whole statutory mode of imposing the tax, embracing all of the proceedings for raising money by the exercise of the power of taxation from their inception to their conclusion (citing *Words and Phrases*, vol. 1, pp. 551-552).

[Ed. Note.—For other cases, see Taxation, Dec. Dig. § 309.*]

4. CONSTITUTIONAL LAW (§ 284*)—DUE PROCESS OF LAW—ASSESSMENT OF TAXES—VALIDITY OF FLORIDA STATUTE.

Laws Fla. 1907, pp. 13, 14, c. 5596, §§ 22, 23, which provides for the assessment of property for not more than three previous years, where it is

*For other cases see same topic & § NUMBER in Dec. & Am. Digs. 1907 to date, & Rep'r Indexes

found to have escaped taxation for any or all of such years, and that the assessors shall complete the assessment rolls before the first Monday in July in each year, and on that date shall meet with the board of county commissioners for the purpose of hearing complaints, and receiving testimony as to the value of any property as fixed by the assessor with power to review and perfect such assessment, of which meeting notice shall be given by publication, afford a property owner a due opportunity to be heard as to the valuation of his property, and a sale of property for non-payment of taxes levied on such an assessment is not without due process of law.

[Ed. Note.—For other cases, see Constitutional Law, Cent. Dig. §§ 893, 894; Dec. Dig. § 284.*]

5. TAXATION (§ 317*)—VALIDITY OF ASSESSMENT—MODE OF COMPENSATING ASSESSOR.

The validity of an assessment made by an assessor is not affected by the fact that he is compensated by a commission on the amount of the taxes levied.

[Ed. Note.—For other cases, see Taxation, Dec. Dig. § 317.*]

6. TAXATION (§ 608*)—INJUNCTION AGAINST COLLECTION OF TAX—GROUND.

A mere irregularity in an assessment or the fact that the tax is excessive will not authorize a court of equity to enjoin its collection.

[Ed. Note.—For other cases, see Taxation, Cent. Dig. §§ 1233, 1234; Dec. Dig. § 608.*]

Persons entitled to injunction restraining or damages for wrongful enforcement of tax, see note to *Bayles v. Dunn*, 54 C. C. A. 550.]

7. TAXATION (§ 608*)—FEDERAL COURTS.

The federal courts will not grant relief by injunction against the collection of taxes imposed on the property of foreign corporations because of the methods adopted by the tax officers in arriving at the valuation of the property, unless fraud is shown, or it is obvious that a wrong principle has been adopted.

[Ed. Note.—For other cases, see Taxation, Cent. Dig. §§ 1233-1235; Dec. Dig. § 608.*]

Taxation of foreign corporations, see note to *McCanna & Fraser Co. v. Citizens' Trust & Surety Co.*, 24 C. C. A. 13.]

In Equity. On motion for preliminary injunction.

The plaintiff, a citizen and a corporation under the laws of the state of Alabama, brings its bill to this court to enjoin the sale of its real estate situated in Walton county, in the Northern district of Florida. The tax sale which the bill seeks to enjoin is for the accrued taxes of the years 1905-06-07, and the amount involved is \$4,080. A rule to show cause with a temporary restraining order was granted, and the cause is now before the court on answer to the rule to show such cause and the motion to dissolve the injunction pendente lite.

The bill mainly attacks the constitutionality of the revenue act of Florida, and, to summarize the allegations of the third paragraph, it charges: That the state statute governing the assessment and collection of taxes authorizes the tax assessor to value real estate without giving notice to the taxpayer, except notice for the purpose of securing from the several taxpayers the description of their real estate. That by the taxing law of the state owners of real estate are neither authorized, permitted, nor required to value their real estate for the purpose of assessment. That there is no provision in the act for complaints to the assessor for excess valuation or to the board of county commissioners (the reviewing and equalizing board) before the assessment made by the assessor becomes final, "except that class of taxpayers, assessment of whose property by the assessor shall have been raised by the board of county commissioners, and with such class the board of county commissioners are required by said assessment laws to give the taxpayers 15 days'

*For other cases see same topic & § NUMBER in Dec. & Am. Digs. 1907 to date, & Rep'r Indexes

notice of the time and place when said board will meet to hear complaints from those of the class of taxpayers who feel aggrieved at the increase of valuation, which may have been made by said board over and above the value fixed by the assessor," "and that it is only this class of taxpayers for whom there is provided any notice to complain or opportunity to be heard." That complainant was not one of the latter class, and, notwithstanding that it had made due return of its property situated in Walton County for assessment, the assessor, without notice to the complainant, had increased complainant's property valuations from \$92,082, as returned by it, to \$221,769, and that the tax laws of Florida require the assessor to complete the assessment rolls by the first Monday of July, 1907, and to deliver the same to the tax collector with his warrant attached requiring the collector to make collection in accordance with said assessment, and to that end to advertise and sell so much of said real estate as may be necessary to satisfy delinquent taxes. That, if such sale is permitted, the purchaser thereat would receive a certificate which after two years will inure into a deed from the state to said real estate. That the assessment made without any provisions in the acts for notice of the increased valuation, and with no provision for an opportunity to be heard by the assessor or board before the assessment became fixed and final is a nullity, as being a deprivation of property without due process of law and in contravention to the fourteenth amendment to the Constitution.

Equitable interference is sought by the bill on the further grounds that, by the statute in question, the compensation of the assessor is fixed on a commission basis on the valuation of the property assessed, his compensation was correspondingly increased, that his action, being of a judicial nature, his assessment was therefore incompetent because of his pecuniary interest therein. It is also averred that the assessor refused to assess the property by the descriptions given by the owner, and arbitrarily adopted his own method of listing the property for taxation.

Wm. W. Flornouy, for complainant.

S. K. Gillis, for defendant.

SHEPPARD, District Judge (after stating the facts as above). It will be observed from this statement of the case that the plaintiff seeks his remedy here on the theory that the tax statute of Florida (chapter 5596, p. 1, Laws Fla. 1907) is defective in respect to the essential requirements of notice and opportunity to the taxpayer, and that the provisions of the statute therefore fail to meet the requirements of due process of law, as ordained by the fourteenth amendment. All that due process implies when applied to tax proceedings may not be readily defined, but enough has been said on the subject by judges and text-writers to leave no uncertainty that the "door of opportunity" must be open to the taxpayer to at least importune and plead with the powers who would "lade him with burdens grievous to be borne." While the process of taxation may not require the same kind of notice as judicial proceedings, or even proceedings for "betterment" assessments, or taking private property under power of eminent domain, the Supreme Court has settled the law that the assessment of a tax is action judicial in its nature, requiring for the legal exertion of that power that opportunity to appear and to be heard is indispensable; that somewhere during the process of assessment the taxpayer must have notice and opportunity to be heard; that it must be provided as an essential part of the statutory provision, and not awarded as a mere matter of grace to the taxpayer. *Weyerhaeuser v. Minn.*, 176 U. S. 550, 20 Sup. Ct. 485, 44 L. Ed. 583; *Central of Ga. v. Wright*, 207 U.

S. 137, 28 Sup. Ct. 47, 52 L. Ed. 137; *Londoner v. Denver*, 210 U. S. 373, 28 Sup. Ct. 708, 52 L. Ed. 1103; *Security Trust Co. v. Lexington*, 203 U. S. 323, 27 Sup. Ct. 87, 51 L. Ed. 204. We have seen that notice is a fundamental requisite to the validity of the assessment, and that it must be provided for in the legislative scheme for taxation, or the statute may be repugnant to the due process requirement of the fourteenth amendment.

Let us examine the provisions of the statute on that subject in order to determine whether the sale of complainant's property in the manner designed by the Legislature would be a deprivation of its property without due process of law; for it is not a question of methods adopted for the assessment, but whether or not the scheme as devised by the law-making power meets the indispensable requirements of notice and opportunity before there is deprivation of property. Unless the statute, which is the foundation of all authority for collection of the tax, secures to the taxpayer this constitutional guaranty of due process, the tax proceeding, however regular, could not import legality to a sale of complainants' property, but, as was recently held by the Supreme Court in *Longyear v. Toolan*, 209 U. S. 417, 28 Sup. Ct. 506, 52 L. Ed. 859:

"If the statute gives him full opportunity to be heard as to the assessment on definite days, and definitely fixes the time for payment and the time for sale in case of default, so that he cannot fail if diligent to learn of the pendency of the sale, he is not denied due process of law because the notice of sale is by publication, and not by personal service."

Referring to the provisions contained in the statute on the subject-matter under consideration, we find authority for the assessment of back taxes contained in section 22, c. 5596, p. 13, Laws 1907, as follows:

"If any county assessor of taxes when making his assessment shall discover that any land in his county has for any reason escaped taxation for any or all of the three previous years, or that any land was illegally sold for taxes and was then liable for taxation, he shall, in addition to the assessment of such lands for that year, assess same separately for such year or years that they may have escaped taxation. * * * Noting distinctly the year when such land escaped such taxation, and such assessment shall have same force and effect as it would have had if made in the year that same escaped taxation, and taxes shall be levied and collected thereon in like manner and together with the taxes of the year in which the assessment is made, but no land shall be assessed for more than three years of taxation, and all lands shall be subject to such taxation, so escaping taxation to be assessed into whose ever hands they may come."

It would seem that the authority for back assessments for the years 1905-06, objected to, was full and explicit, and that the power of the Legislature to subject property which has escaped taxation is too well settled to require more than the citation of cases. *F. C. & P. v. Reynolds*, 183 U. S. 476, 22 Sup. Ct. 176, 46 L. Ed. 283; *Winona & St. Peter Land Co. v. Minnesota*, 159 U. S. 526, 16 Sup. Ct. 83, 40 L. Ed. 247; *Security Trust Co. v. Lexington*, 203 U. S. 323, 27 Sup. Ct. 87, 51 L. Ed. 204.

Now on the question of notice and opportunity, we find the following provisions contained in sections 23 and 24 of chapter 5596, supra:

"The county assessor of taxes shall complete the assessment rolls of their respective counties on or before the first Monday in July in every year, on

which day such assessors shall meet with the board of county commissioners at the clerk's office of their respective counties for the purpose of hearing complaints and receiving testimony as to the value of any property, real, or personal, as fixed by the county assessor of taxes, of perfecting, reviewing and equalizing the assessment, and may continue in session for that purpose from day to day for one week, or as long as shall be necessary. * * *

"Due notice of such meetings shall be given by publication in a newspaper published in such county, or by posting a notice at the court house door, if there be no newspaper published in that county, at least fifteen days before the board will be in session for the purpose of hearing complaints and receiving testimony as to the value of any property as fixed and assessed by County tax assessor; provided, that the county commissioners of any county may, if they deem it necessary, extend the time for the completion of such assessment roll and for the purpose of revising and equalizing the assessment, a similar extension, not exceeding thirty days, giving due notice and opportunity to be heard as to assessment and values as hereinbefore provided.

"Should the board increase the value fixed by the county assessor of taxes of any real estate or personal property, due notice thereof shall be given to the owner or agent of such property by publication in a newspaper published in the county, or by posting a notice at the courthouse door, if there be no newspaper published in the county, at least fifteen days before the board will be in session, to hear any reason that such persons may desire to give why the valuation fixed by the board shall be changed.

"The board shall meet on the first Monday in August or September of each year for the purpose of hearing complaints from owners or agents of any real estate or personal property the value of which shall have been fixed by the assessor, or changed by them, and for that purpose the board shall sit as long as may be necessary.

"Sec. 24. The board of county commissioners shall have full power to equalize the assessment of real estate or personal property in their respective counties, and for that purpose may raise or lower the value fixed by the assessor of any particular piece of real estate or other item or items of personal property."

This act was approved and became operative by its terms June 17, 1907. We have already seen by the express terms of the statute that the assessor shall meet with the board on the first Monday of July of every year, previous notice of which is provided, for the purpose of hearing complaints and receiving testimony as to the valuations fixed by the assessor of any property real or personal, and of reviewing and equalizing the assessment, and, if necessary, extend the time for revising and equalizing, giving due notice and opportunity to be heard as to assessment and value as therein provided. Again, there is further provision for notice and opportunity to be heard by any person complaining because of any raise made in the valuation of his property from that made by the assessor. Section 27 of the act provides that, after the county commissioners shall have reviewed and equalized the tax assessment and the amounts to be raised determined, the assessor shall calculate and carry out the total in separate columns the several amounts to be raised for various purposes.

It may be important so far as the effect of the statute in this case is concerned to know when the assessment was made. The word "assessment," as used in tax statutes, does not mean merely the valuation of the property for taxation. It includes the whole statutory mode of imposing the tax. It embraces all the proceedings for raising money by the exercise of the power of taxation from the inception to the conclusion of the proceedings. Strictly speaking, it is an official esti-

mate of the sums which are to constitute the basis of apportionment of taxes between individuals subject to taxation within the district. As the word is more commonly used, an assessment consists of two processes: Listing the property to be taxed, and of calculating the sums which are to be the guide in the apportionment of the tax between them. 1 Words & Phrases, 551, 552; *U. S. v. Erie Ry.*, 107 U. S. 1, 2 Sup. Ct. 83, 27 L. Ed. 385. Thus it will be seen that the provisions of the statute for notice and opportunity to be heard were effective before the completion of the assessment for the year 1907; and, if the complainant had the benefit of this statute the provisions of which seem adequate for notice and opportunity, can it be said that complainant was by the terms of the act denied due process of law? Personal notice to the taxpayer has not been held essential, nor the strictness of notice usual in court proceedings required. The statute, indeed, should be liberally construed, and tax proceedings will not be declared lacking in due process of law by enforced collection of taxes merely because it may in individual cases work hardships or impose unequal burdens. *King v. Mullins*, 171 U. S. 404, 18 Sup. Ct. 925, 43 L. Ed. 214; *Kelly v. Pittsburg*, 104 U. S. 78, 26 L. Ed. 659; *Hodge v. Muscatine Co.*, 196 U. S. 276, 25 Sup. Ct. 237, 49 L. Ed. 477; *Hibben v. Smith*, 191 U. S. 310, 24 Sup. Ct. 88, 48 L. Ed. 195; *Glidden v. Harrington*, 189 U. S. 255, 23 Sup. Ct. 574, 47 L. Ed. 798. Section 23 of the statute, *supra*, affords to the taxpayer ample opportunity to be heard on the assessment made, and the complainant is bound at his own peril to know the law, and, when the opportunity to be heard is given by the provisions of the statute, it has been held sufficient. *Judson on Taxation*, 325; *Hager v. Reclamation Dist.*, 111 U. S. 701, 4 Sup. Ct. 663, 28 L. Ed. 569. Notwithstanding the fact that the assessor may have increased the valuations without notice, the statute imparted notice and afforded opportunity for complainant, and this in my judgment satisfies the requirement of due process.

The contention that the tax assessor was pecuniarily interested in the amount of taxes imposed or collected by reason of the fact that his compensation was fixed on a percentage basis, and that, therefore, the greater the valuation the greater correspondingly his remuneration, is not sustained by an examination of the statute. The tax assessor is compensated by a commission or per centum, not upon the aggregate valuation of the whole property assessed, but upon the amount of the whole taxes levied. Even had the system pursued tended to increase the compensation of the assessor, the authorities hold that his office is not judicial in the sense that his interest would impugn his judgment, and, further, that his interest would be excused on the ground of necessity. *Cooley on Torts*, 492; 27 *Am. & Eng. Cyc.* (2d Ed.) 665; *Oskamp v. Lewis, Auditor, et al.* (C. C.) 103 Fed. 906.

The objection made against the validity of the assessment because the assessor refused to adopt the description of the property as returned by the taxpayer is not one that can be urged in a court of equity. It was said by Justice Miller in the *State Railroad Cases*, 92 U. S. 575, 23 L. Ed. 663:

"That neither the mere illegality of the tax complained of nor its injustice nor irregularity of themselves give the right to an injunction in a court of equity."

Again the Supreme Court of Florida in *King v. Gwynn*, 14 Fla. 32, has said:

"A bill in equity will not be sustained which seeks to enjoin the collection of a tax on the ground of mere irregularity in the assessment or the excessiveness of the tax."

This would seem sufficient to dispose of this objection, even in the absence of section 2006 of the General Statutes of Florida of 1906, as pointed out by the Supreme Court of this state in *L. & N. Ry. Co. v. Board of Public Instruction*, 50 Fla. 222, 39 South. 481, as the statutory method designed for correction of errors and irregularities of assessment.

After a careful review of the questions submitted, I find no sufficient reason for equitable interference against the collection of the taxes imposed by this assessment. It is a principle of law so well recognized as to become almost a canon of federal jurisdiction that the federal courts will not grant relief by injunction against the collection of taxes imposed on foreign corporations because of the methods adopted by tax officers in arriving at the valuation of the property unless fraud is shown, or it is obvious that a wrong principle has been adopted. *C., B. & Q. Ry. v. Babcock*, 204 U. S. 585, 27 Sup. Ct. 326, 51 L. Ed. 636.

The prayer for injunction pendente lite is denied, and the restraining order heretofore allowed is dissolved

BARLOW v. CHICAGO & N. W. RY. CO.

(Circuit Court, N. D. Iowa, W. D. November 6, 1908.)

No. 466.

1. REMOVAL OF CAUSES (§ 26*)—RIGHT OF REMOVAL—SUIT BY ALIEN AGAINST NONRESIDENT.

An action brought by a nonresident alien in a state court against a citizen of another state is removable by the defendant where the requisite amount is involved.

[Ed. Note.—For other cases, see Removal of Causes, Cent. Dig. § 60; Dec. Dig. § 26.*]

2. REMOVAL OF CAUSES (§ 89*)—REFUSAL OF STATE COURT TO ORDER REMOVAL—FILING COPY OF RECORD IN FEDERAL COURT.

Where a proper petition and bond for the removal of a cause are presented to a state court, the refusal of such court to order the removal does not require the defendant to proceed with the trial in that court, but he may at his option file a copy of the record in the federal court and require the plaintiff to there contest the question of the right of removal, and such is the better practice.

[Ed. Note.—For other cases, see Removal of Causes, Cent. Dig. § 192; Dec. Dig. § 89.*]

On Motion to Remand to State Court.

Charles A. Dickson, for the motion.

Wright, Call & Sargent and James C. Davis, opposed.

*For other cases see same topic & § NUMBER in Dec. & Am. Digs. 1907 to date, & Rep'r Indexes

REED, District Judge. The plaintiff, a nonresident alien, commenced this action in the district court of Iowa in and for Woodbury county to recover of the defendant railway company, an Illinois corporation, damages in excess of \$2,000, for injuries to certain lands in said Woodbury county owned by the plaintiff, alleged to have been caused by the failure of defendant to construct adequate or proper bridges and culverts in its embankment and roadbed over and across said land to permit the natural flow of water courses and surface waters over the same, and thereby caused the land to be overflowed and flooded in times of high water, to plaintiff's damage in the sum alleged, for which he asks judgment against the defendant railway company. The defendant seasonably filed in the state court its petition and bond in due form, with sufficient sureties, for the removal of the cause to this court upon the ground that at the time the action was commenced the plaintiff was, and ever since has been, an alien, viz., a citizen and subject of the kingdom of Great Britain and Ireland residing in England, and the defendant a railway corporation organized and existing under the laws of Illinois and never incorporated under the laws of Iowa. The state court refused to grant the petition for removal. The defendant thereupon filed a copy of the record in this court, and asks that it take jurisdiction of the cause, and the plaintiff moves to remand upon the alleged ground that this court is without jurisdiction thereof.

It is earnestly contended in support of the motion to remand that, as neither the plaintiff nor the defendant was a citizen or resident of Iowa and of this district when the action was commenced, it could not rightly have been brought by original process in this court, and is not therefore one that is removable from the state court. It is admitted by counsel for the plaintiff that this contention is opposed to the holding of this court in *Iowa Lillooet Gold Mining Co. v. Bliss et al.*, 144 Fed. 446; but it is urged, with much confidence apparently, that that holding is contrary to *Ex parte Wisner*, 203 U. S. 449, 27 Sup. Ct. 150, 51 L. Ed. 264, and for that reason should be overruled. In this contention counsel ignores the difference in the citizenship of the parties in *Ex parte Wisner*, and that of the parties in the *Lillooet Case*. In *Ex parte Wisner* the jurisdiction of the Circuit Court is founded alone upon the fact that the action was between citizens of different states, in which case the act of 1887-88 (Act March 3, 1887, c. 373, § 1, 24 Stat. 552 [U. S. Comp. St. 1901, p. 508]) expressly provides that "suit shall be brought by original process only in the district of the residence of either the plaintiff or the defendant"; and there is language in the opinion indicating that it was intended to hold that the place where the suit is so required to be brought is jurisdictional, and may not be waived by both parties to the suit.

In the *Iowa Lillooet Case* the plaintiff was a Canadian corporation having an office and place of business in Iowa, the defendant Bliss a citizen of Iowa residing in this district, and the defendant United States Fidelity & Guaranty Company a Maryland corporation doing business in Iowa. The action was brought originally in a state court of Iowa, and removed by the defendant guaranty company to this

court, upon the ground that it was a corporation of Maryland and the plaintiff a Canadian corporation, between whom there was a separable controversy to the full and complete determination of which the defendant Bliss was not a necessary, or even proper, party, and that he was fraudulently joined as defendant with the guaranty company to prevent it from removing the cause to this court. The plaintiff objected to the removal, and moved to remand, upon two grounds: (1) That there was no separable controversy between it and the guaranty company; and (2) that the action could not have been brought originally in this court, and was not therefore one that was removable from the state court. Upon the latter question it is said in the course of the opinion:

"The motion to remand challenges the jurisdiction of this court, and in support thereof it is urged that, plaintiff being a corporation of Canada, and defendant a corporation of Maryland, neither being a citizen or resident of Iowa, the action could not have been brought by original process in this court, and is not therefore one that is removable from the state court. This contention fails to distinguish between the jurisdiction or right of a court to determine a controversy, and the venue or place where that jurisdiction may be exercised. The first part of section 1 of the judiciary act of 1887-88 confers jurisdiction upon the Circuit Courts of the United States, concurrent with the courts of the several states, of all suits of a civil nature, at law or in equity, wherein the requisite amount is involved, and in which there shall be a controversy between, * * * (3) citizens of different states, and * * * (5) citizens of a state and foreign states, citizens or subjects. The second part of that section provides that no civil suit shall be brought against any person in a circuit court of the United States by original process in any other district than that whereof he is an inhabitant; but 'when the jurisdiction is founded only upon the fact that the action is between citizens of different states, suit shall be brought only in the district of the residence of either the plaintiff or the defendant.' This suit is not of the class there described, for plaintiff is a corporation of Canada, defendant Bliss a citizen and resident of the Northern District of Iowa, and the guaranty company a corporation of Maryland. If it is one of which this court has jurisdiction, it might therefore have been brought in this court by original process against defendant Bliss, and if the guaranty company is jointly liable with him on its bond, against that company also, especially if it did not object to being sued there, and is removable to this court if it is within the terms of the removal section."

It is clear from this excerpt from the opinion that, in determining the question thus presented, suits between citizens of different states were carefully distinguished from those between aliens and citizens. It may be conceded that in the further course of the opinion there is language which, considered apart from the facts actually presented for determination, might indicate that it was intended to apply also to suits between citizens of different states, and it is quite probable that at that time the holding in such a suit would have been the same as in one between an alien and a nonresident citizen, in view of the prior decisions of the Supreme Court, and the opinion of Mr. Justice Brewer, then Circuit Judge of this circuit, in *Kansas City T. & Ry. Co. v. Interstate Lumber Co.*, 37 Fed. 3, and of Mr. Justice Gray in *Amisnick v. Balderston*, 41 Fed. 641, and many other cases in the circuit courts. But if it had been so held in a suit between citizens of different states, where the plaintiff had timely objected to the removal, it would have been error under the later holding in *Ex parte Wisner*,

as that case is interpreted in *Re Moore*, 209 U. S. 490, 28 Sup. Ct. 585, 706, 52 L. Ed. 904, and *Western Loan & Savings Ass'n v. Butte & Boston Mining Co.*, 210 U. S. 368, 28 Sup. Ct. 720, 52 L. Ed. 1101. But the actual holding in the *Iowa Lillooet Case* must be restricted to the facts then before the court for determination; and, so restricted, it is clear that nothing so held conflicts with *Ex parte Wisner*, which, as interpreted in the two later cases above cited, differs from the prior decisions of the Supreme Court only in holding that under the act of 1887-88 the consent of both plaintiff and defendant is requisite to the maintenance of a suit in a circuit court of the United States in a state and district where neither resides, when brought there by original process or by removal, where the jurisdiction is founded only upon the fact that the action is between citizens of different states. But this provision of the act and *Ex parte Wisner* have no application to suits between aliens and citizens. In *re Hohorst*, 150 U. S. 653-660, 14 Sup. Ct. 221, 37 L. Ed. 1211; *Barrow Steamship Co. v. Kane*, 170 U. S. 100-112, 18 Sup. Ct. 526, 42 L. Ed. 964; *Campbell v. Duluth S. S. & A. Ry. Co.* (C. C.) 50 Fed. 241 (Sanborn, Circuit Judge); *Cucciarre v. New York Cent. & H. R. R. Co.* (C. C. A., 7th Circuit) 163 Fed. 38-41; *Sherwood v. Newport News Co.* (C. C.) 55 Fed. 1; *Stalker v. Pullman Car Co.* (C. C.) 81 Fed. 889; *Creagh v. Equitable Life Ass'n* (C. C.) 83 Fed. 849.

The language of the act would seem to permit of no other construction, for, after providing that no civil suit shall be brought before a district or circuit court of the United States against any person by original process in any other district than that whereof he is an inhabitant, "but where the jurisdiction is founded only upon the fact that the action is between citizens of different states, suits shall be brought only in the district of the residence of either the plaintiff or the defendant," the second clause of the removal section provides that:

"Any other suit of a civil nature at law or in equity of which the Circuit Courts of the United States are given jurisdiction by the preceding section, which may now be pending or which may hereafter be brought in any state court, may be removed into the Circuit Court of the United States for the proper district by the defendant or defendants therein, being nonresidents of that state."

As the place of bringing the suit is not jurisdictional, the removal from a state court of the suit of an alien against a nonresident citizen by the latter is within the very letter of the clause of the removal act above set out, even against the objection of the alien plaintiff when timely interposed.

If the suit had been brought originally in this court, the defendant undoubtedly might have seasonably objected that it was not suable here without its consent. *Shaw v. Quincy Mining Co.*, 145 U. S. 444, 12 Sup. Ct. 935, 36 L. Ed. 768; *Campbell v. Duluth S. S. & A. Ry. Co.* (C. C.) 50 Fed. 241, above. But having removed the cause from the state court, it has waived its right to afterwards object to the jurisdiction of this court, unless the court from which it was removed did not have jurisdiction. *Cowley v. Northern Pac. Co.*, 159 U. S. 569-583, 16 Sup. Ct. 127, 40 L. Ed. 263; In *re Moore*, 209 U. S. 490, 504, 505, 28 Sup. Ct. 585, 706, 52 L. Ed. 904, and cases cited; West-

ern Loan & Savings Ass'n v. Butte & Boston Mining Co., 210 U. S. 368, 28 Sup. Ct. 720, 52 L. Ed. 1101; Tootle v. Coleman, 107 Fed. 41-45, 46 C. C. A. 132, 57 L. R. A. 120.

It may be said that these cases apply to defendants only, and are inapplicable to a plaintiff who at the earliest opportunity objects to the removal and persistently insists upon his objection. A sufficient answer to this is (1) that the restrictive clause of the act as to the place where suits shall be brought between citizens of different states is not applicable to suits between aliens and citizens (*In re Hohorst*, 150 U. S. 653-660, 14 Sup. Ct. 221, 37 L. Ed. 1211; *Barrow Steamship Co. v. Kane*, 170 U. S. 100-112, 18 Sup. Ct. 526, 42 L. Ed. 964; *Campbell v. Duluth S. S. & A. Ry. Co.* (C. C.) 50 Fed. 241, above); (2) that the petition and bond for removal are in the nature of process (*Kinney v. Columbia Savings Ass'n*, 191 U. S. 78, 24 Sup. Ct. 30, 48 L. Ed. 103), and by bringing the suit in the state court the plaintiff voluntarily subjects himself to the service of such process in the only manner authorized or required by the removal act, viz., by filing the petition and bond in due form, with sufficient sureties, in the state court where the action is pending within the prescribed time (section 1, Act 1887-88; *In re Moore*, 209 U. S. 490-504-505, 28 Sup. Ct. 585, 706, 52 L. Ed. 904).

If a petition is so filed by the nonresident defendant in a suit in a state court, and shows upon its face a controversy between the plaintiff and defendant of which a circuit court of the United States is given jurisdiction by the judiciary act, and the bond is sufficient, it is the duty of the state court to proceed no further with such suit. No order of removal is required to confer jurisdiction upon the circuit court, and no refusal to make such order will prevent the jurisdiction of that court from attaching, and all questions of the truth of the facts alleged in the petition for removal are to be determined in the circuit court. *Removal Cases*, 100 U. S. 457-472, 25 L. Ed. 593; *Kern v. Huidekoper*, 103 U. S. 485-490, 26 L. Ed. 354; *Railroad Co. v. Koontz*, 104 U. S. 5-14, 15, 26 L. Ed. 643.

Finally, it is urged that because the state court refused to order the removal the defendant's only recourse is to proceed with the trial in the state court, and, if the judgment is ultimately against it, take the case to the Supreme Court of the United States upon writ of error to the state Supreme Court. That it is open to the defendant to adopt that course, especially if the state court should proceed with the trial, may be conceded; but it is unnecessary to cite authorities to show that defendant is not required to do so, but may at once file a copy of the record in this court and require the plaintiff to there contest the question of removal with him; and that this is the better practice has been many times held by the Supreme Court. *Removal Cases*, 100 U. S. 457-472, 25 L. Ed. 593; *Kern v. Huidekoper*, 103 U. S. 485-490, 26 L. Ed. 354; *Railroad Co. v. Koontz*, 104 U. S. 5-14, 15, 26 L. Ed. 643; and *B. C. R. & N. Ry. Co. v. Dunn*, 122 U. S. 513-517, 7 Sup. Ct. 1262, 30 L. Ed. 1159.

The conclusion, therefore, is, that the ruling in *Iowa Lilloet Gold Mining Co. v. Bliss* upon the facts there involved in this branch of

that case does not conflict with anything held in *Ex parte Wisner*, especially as that case is interpreted in the later cases of *In re Moore and Western Loan & Savings Ass'n v. Butte & Boston Mining Co.*, above.

The motion to remand is therefore denied.

INTERSTATE RY. CO. et al. v. PHILADELPHIA, B. & T. ST. RY. CO. et al.
(Circuit Court, E. D. Pennsylvania. October 5, 1908.)

No. 165.

1. COURTS (§ 500*)—FEDERAL AND STATE COURTS—PRIORITY OF JURISDICTION.

A suit by a mortgage creditor of a corporation in a state court, asking for the appointment of receivers, and in which temporary receivers were appointed, although the appointment was afterward vacated pending a hearing on the issues joined, is a suit *in rem*, which gives such court exclusive jurisdiction of the property until it is concluded, and a federal court will not, while it is pending, appoint receivers for the property in a suit against the same defendants, subsequently commenced therein, by a different complainant, who may intervene in the suit in the state court, although the bill therein does not expressly state that it is filed on behalf of all creditors.

[Ed. Note.—For other cases, see Courts, Cent. Dig. § 1408; Dec. Dig. § 500.*]

2. COURTS (§ 500*)—FEDERAL AND STATE COURTS.

In such case the complainant in the state court has the right to appear in the federal court without leave for the special purpose of raising the question of the court's jurisdiction.

[Ed. Note.—For other cases, see Courts, Dec. Dig. § 500.*]

In Equity. On petition to vacate the appointment of temporary receivers.

Layton M. Schoch, Wm. C. Ryan, and George Quintard Horwitz, for petition.

Wm. N. Trinkle, John C. Bell, and Richmond L. Jones, opposed.

HOLLAND, District Judge. This is a petition filed, praying the court to vacate the appointment of the temporary receivers. On September 5, 1908, Charles F. Wagner, Jr., filed a bill in equity in the court of common pleas of Bucks county against the same defendants mentioned in this suit, praying the court to appoint temporary receivers to take charge of the property, real and personal, of the Philadelphia, Bristol & Trenton Street Railway Company, because of a default in the payment of interest and for other reasons. The plaintiff in the Bucks county bill and petitioner here is the holder of 10 bonds, secured by a mortgage issued by the railway company, of which the Union Trust Company of Maryland is trustee; the total bond issue being \$650,000. The court appointed temporary receivers, who, two days later, gave bond in the sum of \$20,000. On September 10th the defendants in this case entered their appearance in the Bucks county suit, filed a petition for the vacation of the Bucks county receivership,

*For other cases see same topic & § NUMBER in Dec. & Am. Digs. 1907 to date, & Rep'r Indexer

which was there argued, and on September 18th the president judge of Bucks county vacated the appointment of the receivers upon the ground that there was no pressing emergency shown for the appointment, and that the management of the property should not have been taken out of the control of the owners before a hearing and a full consideration of the merits of the bill. The opinion further states:

"The court does not wish to indicate what the final action will be. The merits of the case can be best determined upon an issue framed to the pleadings of the bill. The cost on the temporary receivership will abide the final disposition of the bill."

On the latter date, to wit, September 18th, a bill was filed in this court by the above plaintiffs, upon which temporary receivers were appointed, and on September 24th the plaintiff in the Bucks county bill presented a petition in this court to vacate the appointment of the temporary receivers here.

The answer to this petition sets up (1) that Charles F. Wagner, Jr., is a stranger to the proceedings; (2) that the plaintiffs in this case are citizens of another state, and have a constitutional right to be heard in the United States courts; (3) and that the Bucks county bill, filed in behalf of Charles F. Wagner, Jr., alone, is not a suit between the same parties, and that it is only in its incipient stage, having progressed no further than the filing of the bill, so that the Bucks county court never acquired jurisdiction of the parties to the bill as they appear in this suit.

The bill in Bucks county was filed 12 days before the filing of the bill in this suit. The county court has concurrent jurisdiction with the federal court to hear and determine the questions involved in this suit, and the parties have a right to be heard in a federal court only when a state court has not previously taken jurisdiction of the cause. Receivers were appointed by the state court, who took charge of the real and personal property of the defendant, although their appointment was subsequently revoked. This bill was filed against the same defendants that appeared in that suit, and the same property was involved. It is an action in rem, and, the Bucks county court having taken jurisdiction of the res, this court could not interfere. Property is deemed to be in the custody of a court from the time the suit or action seeking to have it placed there has been actually begun, either by levy or a writ in a proceeding in rem (*Taylor v. Carryl*, 61 U. S. 583, 5 L. Ed. 1028; *Heidritter v. Elizabeth Oilcloth Co.*, 112 U. S. 294, 5 Sup. Ct. 135, 28 L. Ed. 729), or by the filing of a bill praying the appointment of a receiver (*Farmers' Loan & Trust Co. v. Lake St. Railway Co.*, 177 U. S. 51, 20 Sup. Ct. 564, 44 L. Ed. 667; *Covell v. Heyman*, 111 U. S. 176, 4 Sup. Ct. 355, 28 L. Ed. 390).

This being a proceeding in rem naming the same defendants, the fact that the bill in the state court failed to state it was filed on behalf of all others interested can make no difference, when the bill shows it is filed for all parties interested, and when all parties may intervene in the suit in the state court who can show a right to do so. This court will not seize upon such an unsubstantial reason to take jurisdiction of a suit pending in a state court which was first instituted

there. It is necessary to exercise great care that no conflict of authority shall occur in cases of concurrent jurisdiction between the federal and state courts. When one has acquired jurisdiction over the property of a defendant, it will be its right to hear and determine all controversies relating thereto without interference on the part of the other, and for the time being its control in the matter ousts all other courts of co-ordinate jurisdiction from exercising a like power; nor will inquiry be made in the other court as to the jurisdiction of the court in which the suit is pending for any reason. That is a matter to be raised there by any interested party asserting it. The petitioner had a right to appear for the special purpose of raising the question of this court's jurisdiction, and was not required to petition for intervention, as he would thereby be held to appear generally, even though he disclaimed any intention to be made a party, and he could not object to the court's jurisdiction over him. 1 Foster's Practice, §§ 100, 201a; *Bowdoin College v. Merritt* (C. C.) 59 Fed. 6.

As it clearly appears the matter is still pending in the state court, this court will not interfere. The bill will not be dismissed at this time, but all proceedings will be stayed until the further order of the court.

The appointment of John A. Riggs and George Blakiston, temporary receivers, will be revoked; and it is so ordered.

UNITED STATES v. LOCKWOOD.

(District Court, D. New Jersey. October 23, 1908.)

No. 15.

INTERNAL REVENUE (§ 47*)—VIOLATION OF OLEOMARGARINE ACT—INDICTMENT.
 An indictment founded on section 6 of the oleomargarine act of August 2, 1886, c. 840, 24 Stat. 210 (U. S. Comp. St. 1901, p. 2230), charging a retail dealer with having violated said section and the regulations prescribed thereunder by failing to pack oleomargarine sold by him as therein required, must describe the package used with reasonable certainty so as to advise the defendant of the particular offense charged, and a general averment that "the said oleomargarine was not then and there packed in new, suitable wooden or paper packages having marked or branded thereon the name and address of him, * * * the words 'pound' and 'oleomargarine' and the quantity of oleomargarine so sold as aforesaid," but which fails to specify in which respect the package used was unlawful, is insufficient as being too indefinite and uncertain.

[Ed. Note.—For other cases, see Internal Revenue, Dec. Dig. § 47.*]

On Demurrer to Indictment.

John B. Vreeland, for United States.
 Merritt Lane for defendant.

LANNING, District Judge. This indictment is founded on section 6 of the oleomargarine act of August 2, 1886, c. 840, 24 Stat. 210

*For other cases see same topic & § NUMBER in Dec. & Am. Digs. 1907 to date, & Rep'r Indexes

(U. S. Comp. St. 1901, p. 2230; 3 Fed. Stat. Ann. 122). That section provides that:

"Retail dealers in oleomargarine must sell only from original stamped packages, in quantities not exceeding ten pounds, and shall pack the oleomargarine sold by them in suitable wooden or paper packages, which shall be marked and branded as the Commissioner of the Internal Revenue, with the approval of the Secretary of the Treasury, shall prescribe."

The indictment charges that Lockwood was, on January 10, 1908, a retail dealer in oleomargarine at Newark, N. J. It sets forth the regulations of the Commissioner of Internal Revenue, approved by the Secretary of the Treasury, that new wooden or paper packages similar to those usually employed in selling butter or lard at retail may be used by the retail dealer in oleomargarine, and that each retailer's wooden or paper package must have the name and address of the dealer, and the words "pound" and "oleomargarine" printed or branded thereon, in letters not less than one-quarter of an inch square, and the quantity written, printed, or branded thereon in figures of the same size. The indictment further charges that on January 10, 1908, Lockwood, as such retail dealer, did "knowingly sell certain oleomargarine, to wit, three pounds of oleomargarine, to one Mrs. Mary Parker, of number two hundred and one Lafayette street, in Newark aforesaid, which said oleomargarine was not then and there packed in new, suitable wooden or paper packages having marked or branded thereon the name and address of him, the said Oscar L. Lockwood, the words 'pound' and 'oleomargarine,' and the quantity of oleomargarine so sold as aforesaid." The conclusion of the indictment is "that the said Oscar L. Lockwood, on the tenth day of January, one thousand nine hundred and eight, at Newark, aforesaid, in the district aforesaid and within the jurisdiction of this court, in manner and form aforesaid, did knowingly, willfully and unlawfully sell and offer for sale, and deliver and offer to deliver, oleomargarine not then and there packed in new wooden or paper packages, marked and branded as the Commissioner of Internal Revenue, with the approval of the Secretary of the Treasury, had then and there prescribed; contrary to the form of the statute in such case made and provided, and against the peace and dignity of the United States." One of the objections to the indictment raised by the demurrer is that the charge against the defendant is wholly in negative terms, without giving him reasonable information as to the manner in which the oleomargarine was packed.

It is a general rule that where the offense is purely statutory it is sufficient to charge the defendant with acts coming fully within the statutory description in the substantial words of the statute. But, as was said in *United States v. Simmons*, 96 U. S. 360, 24 L. Ed. 819:

"To this general rule there is the qualification, fundamental in the law of criminal procedure, that the accused must be apprised by the indictment, with reasonable certainty, of the nature of the accusation against him, to the end that he may prepare his defense, and plead the judgment as a bar to any subsequent prosecution for the same offense."

In *Evans v. United States*, 153 U. S. 587, 14 Sup. Ct. 936, 38 L. Ed. 830, it was said:

"Even in the cases of misdemeanors, the indictment must be free from all ambiguity, and leave no doubt in the minds of the accused and the court of

the exact offense intended to be charged, not only that the former may know what he is called upon to meet, but that, upon a plea of former acquittal or conviction, the record may show with accuracy the exact offense to which the plea relates."

And in *United States v. Hess*, 124 U. S. 487, 8 Sup. Ct. 573, 31 L. Ed. 516, it was declared, as it had been previously held in *United States v. Cruikshank*, 92 U. S. 558, 23 L. Ed. 588, that:

"It is an elementary principle of criminal pleading that where the definition of an offense, whether it be at common law or by statute, includes generic terms, it is not sufficient that the indictment shall charge the offense in the same generic terms as in the definition; but it must state the species, it must descend to particulars."

The section of the congressional act and the regulations of the Commissioner of Internal Revenue, on which the indictment now under review is founded, will be violated if the package in which the oleomargarine is contained be not a new wooden or paper one, or if the name and address of the retail dealer, or the word "pound," or the word "oleomargarine," be not printed or branded on the package, or if the quantity be not written, printed, or branded thereon, or if any of the words or figures required to be written, printed, or branded thereon be written, printed, or branded in letters or figures less than one quarter of an inch square. The indictment fails to inform the defendant which of these particular possible violations he is required to meet. In the *Kollock Case*, 165 U. S. 526, 17 Sup. Ct. 444, 41 L. Ed. 813, the indictment charged that the oleomargarine sold and delivered by the defendant in that case was "'packed' in a paper package upon which there had not been printed, branded, or written any or either of the marks and characters aforesaid so required by the said regulations to be placed thereon." In *Dougherty v. United States*, 108 Fed. 56, 60, 47 C. C. A. 195, 199, the indictment charged that the defendant sold a pound of oleomargarine "'packed' in a plain wrapper, and not in a new and suitable wooden or paper package or packages, as then and there required by the act of Congress," etc. And in *United States v. Joyce* (D. C.) 138 Fed. 459, one of the defects pointed out by Judge Archbald in the indictment then before him, though it was done interrogatively, was that the indictment failed to show in what respect the packages of oleomargarine, for the sale of which the defendant was there indicted, were not in the prescribed form.

The rule of good pleading requires that, in an indictment founded on section 6 of the oleomargarine act and the regulations prescribed under the authority of that section, the nature or form of the package in which the oleomargarine is sold by a retail dealer shall be described with reasonable certainty, if the offense intended to be charged is that the package was not a new wooden or paper one; and if the offense intended to be charged be that the defendant did not mark or brand the package in the manner prescribed by the regulations, the particular violation of the law in that respect should be averred with reasonable certainty. In the present case, the defendant is not informed whether the government intends to show that he used a package not authorized by law, or whether, using a package which is authorized by law, he

failed to write or print on it, or to brand it, in the manner required by law. For this reason the indictment is too uncertain and indefinite. The demurrer must therefore be sustained.

THE BENJAMIN A. VAN BRUNT.

(District Court, E. D. Pennsylvania. November 16, 1908.)

No. 30.

SALVAGE (§ 34*)—AMOUNT OF COMPENSATION—RESCUE OF SCHOONER DISABLED AT SEA.

A schooner laden with railroad ties, and worth with her cargo and freight from \$26,000 to \$40,000, was so injured in a collision off the New Jersey coast, while on a voyage from Savannah to New York, that she became water-logged and settled until the waves washed her decks. While not in danger of sinking owing to the nature of her cargo, she was practically helpless, being unable to use her sails or anchors, and in some danger of being driven ashore, and of further collision with other vessels at night. In response to her distress signals libelants' tug, on the way to Baltimore with three tows, also took her in tow to the Delaware Breakwater, where she was left and afterward temporarily repaired and taken to New York with the larger part of her cargo. In performing the service, the tug deviated from her course some 35 miles and consumed 30 hours. She was worth, with her tows and cargo, some \$200,000. The service was not attended with any special danger. *Held* that, while it was a salvage service, it was not of a high order of merit, and that the tug was entitled to a salvage award of \$3,500.

[Ed. Note.—For other cases, see Salvage, Cent. Dig. § 81; Dec. Dig. § 34.*]

In Admiralty. Suit for salvage.

Howard M. Long, for libellant.

Henry R. Edmunds, for respondent.

J. B. McPHERSON, District Judge. This is a suit in which the respondent admits that the libellant rendered the services of a salvor, but objects to the estimate put upon their value.

The facts are as follows: The schooner Benjamin A. Van Brunt is a four-masted vessel of 1,146 tons, and on May 3, 1907, was prosecuting a voyage from Savannah to New York, carrying a cargo in the hold and on deck of about 19,700 pine railroad ties. At 11 o'clock in the night of that day she was much injured by a collision with another schooner, five or six miles northeast of the Five Fathom Bank lightship. Her bowsprit, fore rigging, and much of her headgear were carried away; one of her lumber ports was stove in; and her anchors were forced overboard, hanging in such a position that they could neither be raised nor lowered. As a consequence of her injuries, she speedily became water-logged, and sank so deep that the waves dashed over her decks continuously. Some of her hatches were burst open, and several hundred of the ties, both from the hold and the deck, were dashed away. Although the buoyant nature of her cargo removed all danger of sinking, she was practically helpless. She could not use her sails because of the risk that she might turn over if the at-

*For other cases see same topic & § NUMBER in Dec. & Am. Digs. 1907 to date, & Rep'r Indexes

tempt was made to hoist them, and she had no auxiliary power. Neither could she use her pumps, even if they would have been effective. The crew and officers, consisting of nine persons, had no other place of refuge than the top of the after house, and no other food than a barrel of hard bread. The nearest land was Sea Isle City on the New Jersey coast, about 10 miles to the westward, and the schooner was therefore directly in the track of coasters and was exposed to the danger of a second collision at night or during a possible fog. Moreover, if the wind should get into the east she would almost certainly be driven ashore, and might become a wreck. Her situation had this advantage, however, that she could not escape observation, and was sure to be picked up sooner or later. Both the wind and the sea were probably high when the collision occurred, and they continued to be rather severe during the early part of May 4th, for in the morning of that day a tramp steamship made some effort to take the schooner in tow, but was finally obliged to abandon the attempt. About two o'clock in the afternoon, the tug *Savage*, of Baltimore (owned by the Consolidation Coal Company), towing a string of three barges to her home port, sighted the schooner, which was then flying a signal of distress, and came near to investigate her condition. By this time the wind was no more than fresh from the west or northwest, and the sea, while still choppy, had gone down so much that the tug's approach required little more than ordinary caution. The master of the schooner asked to be towed to the Delaware Breakwater, and the tug agreed to undertake the service, but the subject of compensation was not referred to. The schooner was accordingly placed first in the tow, the hawser of the foremost barge being detached from the tug and fastened to the schooner's stern, and a new 10-inch manila hawser about 900 feet long, belonging to the tug, being fastened to the schooner's bow. This maneuver was effected without any serious difficulty. There was the usual need for caution lest the tug and schooner should collide, and also lest the crew of the tug should become entangled in the hawser and suffer injury, but there was no extraordinary peril for either of these reasons, and the rearrangement of the tow was speedily accomplished.

Apparently, the shortest course to the breakwater would have been across Five Fathom Shoal, and this direction would no doubt have been pursued if the tug had known that the anchors of the schooner were not hanging below her keel. They could not be seen, however, and the master of the schooner was unable to inform the tug how much chain had run out. In order, therefore, to be sure of having enough water, the tug rounded the eastern and southern edges of the shoal, and thereby lengthened the voyage by several miles. She reached the breakwater safely about noon of May 5th, and placed the schooner on the mud, at her master's request, proceeding promptly thereafter on her course toward Baltimore. The voyage from the point where the tug took hold of the schooner had been neither eventful nor especially hazardous. Owing to the water-logged condition of the vessel, the schooner's rudder was abnormally deep in the water, and, although it was used during the night, it was less serviceable than it

would otherwise have been, and increased to some extent the difficulty of towing the injured ship. Her side lights were not in their usual place. Some attempt was made to show them, but it seems to have been confusing at the best, and this added an element, but not a very considerable element, of danger to the progress of the tow during the night. A more careful lookout by the tug was also rendered necessary by reason of the schooner's presence. The speed of the *Savage*, although not more than $3\frac{1}{2}$ miles at the most, was as fast as she was able to go. Her engines were run to their capacity, and consumed from 15 to 17 tons of coal extra in performing the salvage service. The whole distance covered by the tug was 56 or 57 miles, but, while the breakwater lay to the west of her route to Baltimore, the general direction to both places was the same, and the total deviation from the original course was probably not more than 35 miles, and the time lost not more than 30 hours. The schooner was afterward towed to Philadelphia by another tug, was repaired temporarily at that port, and afterwards towed to New York—the towing charges for both services and the cost of repairs aggregating about \$1,100—and delivered there 16,500 ties, this being what was left of her cargo. She thus earned, and was paid, a gross freight of \$3,052.50, from which certain deductions should be made, the net amount of the freight being a matter of dispute.

The total value of the tug, her three barges, and the cargo, of the barge that was loaded—the other two being light—is given by the master as \$202,500; and, while this sum seems to me to be excessive, no testimony to the contrary was offered, and I have no means of correcting the estimate, if correction be needed. The monthly wages paid to the officers and crew of the tug were \$850. It is more difficult to arrive at the value of the schooner, her cargo, and the freight, since there is conflicting testimony upon each of these subjects. The totals appearing from the testimony range between \$26,000 and \$40,000, but I do not think it is essential to determine with accuracy what sum approaches most nearly to the truth. When the schooner reached Philadelphia, an offer of \$2,500 as compensation for the salvage service was made on her behalf to the libellant before the suit was brought, but no legal tender of this sum was made, and the money was not paid into court after the action was begun. The offer was refused, and a libel was filed asking for an award of \$15,000.

Upon these facts the only question is the amount for which a decree should be entered, and the elements that should influence the court in coming to a conclusion appear in the foregoing statement. It would do little good to discuss them in detail. It is their total effect that is decisive, and this effect may, and probably will, vary as the minds vary to which these elements are presented. For myself, I can only say that I do not regard the libellant's service, although it was no doubt meritorious, as entitled to a high rank. It ought to be well paid, but the sum demanded in the libel is out of the question. Taking everything into account, my best judgment is that the service will be adequately compensated by the sum of \$3,500, and for this amount, with costs, a decree may be entered.

UNITED STATES v. 646 HALF-BOXES OF FIGS et al.

SAME v. 82 HALF-BOXES OF CHEESE.

(District Court, E. D. New York. June 13, 1908.)

1. CUSTOMS DUTIES (§ 130*)—FORFEITURE—ILLEGAL ENTRY BY ABSENTEE—AGENCY.

Forfeiture for illegal entry under Customs Administrative Act June 10, 1890, c. 407, § 9, 26 Stat. 135 (U. S. Comp. St. 1901, p. 1895), does not accrue against a party who was in another country when the entry was made, where it does not appear that the person making the entry at the custom house was his agent.

[Ed. Note.—For other cases, see Customs Duties, Dec. Dig. § 130.*]

2. CUSTOMS DUTIES (§ 125*)—ILLEGAL ENTRY—"SMUGGLE OR CLANDESTINELY INTRODUCE."

Section 2865, Rev. St. (U. S. Comp. St. 1901, p. 1905), making it criminal to "smuggle or clandestinely introduce" merchandise into the United States, does not include a case where merchandise is fraudulently entered at the customhouse.

[Ed. Note.—For other cases, see Customs Duties, Dec. Dig. § 125.*]

3. CUSTOMS DUTIES (§ 64*)—CERTIFICATION OF INVOICES—VERIFICATION.

Customs Administrative Act June 10, 1890, c. 407, § 3, 26 Stat. 131 (U. S. Comp. St. 1901, p. 1887), providing for the indorsement on invoices of a declaration before a United States consul, does not require the invoices to be verified.

[Ed. Note.—For other cases, see Customs Duties, Dec. Dig. § 64.*]

4. CUSTOMS DUTIES (§ 125*)—ILLEGAL IMPORTATION—ACTS BY EXPORTER.

It was alleged that an exporter had caused a false and fraudulent invoice to be made out, signed, verified, and left with a consul to be transmitted to the collector of customs at an American port, and had then caused the merchandise covered by the invoice to be shipped to said port; but it was not charged nor shown that he had been concerned in importing the goods. *Held*, that the case was not brought within section 2865, Rev. St. (U. S. Comp. St. 1901, p. 1905), forbidding any person to "make out or pass, or attempt to pass, through the customhouse any false, forged, or fraudulent invoice."

[Ed. Note.—For other cases, see Customs Duties, Dec. Dig. § 125.*]

5. CUSTOMS DUTIES (§ 133*)—INFORMATION FOR FORFEITURE—SUFFICIENCY.

Where, in an information for forfeiture, allegations were united from which it might be inferred that the matter could be brought under various sections of the law, but which were insufficient for the ground of forfeiture intended by the Government, and where no sufficient ground was actually stated, exceptions to the sufficiency of the information should be sustained.

[Ed. Note.—For other cases, see Customs Duties, Dec. Dig. § 133.*]

In Rem. On demurrer to information for forfeiture.

Among the statutory provisions involved herein is the following portion of Customs Administrative Act June 10, 1890, c. 407, § 3, 26 Stat. 131 (U. S. Comp. St. 1901, p. 1887):

"Sec. 3. That all such invoices shall, at or before the shipment of the merchandise, be produced to the consul * * * of the United States of the consular district in which the merchandise was manufactured, as the case may be, for export to the United States, and shall have indorsed thereon, when so produced, a declaration signed by the purchaser, manufacturer, owner or agent, setting forth that the invoice is in all respects correct and true."

*For other cases see same topic & § NUMBER in Dec. & Am. Digs. 1907 to date, & Rep'r Indexes

William J. Youngs, U. S. Atty.
J. Bronson Ker, for claimants.

CHATFIELD, District Judge. The government has proceeded against two separate importations, and has based its right to forfeiture upon three alleged grounds in each case. These grounds are alike in the two cases, with the exception that in the information against Eighty-Two Half Boxes of Cheese, the second alleged cause of forfeiture recites that the acts are claimed to be in violation of the provisions of section 2865 of the Revised Statutes (U. S. Comp. St. 1901, p. 1905), in addition to a number of other sections.

As to the first cause of forfeiture, the question has already been disposed of in previous cases; and while this court had some doubt as to the meaning of section 9 of the customs administrative act (Act June 10, 1890, c. 407, 26 Stat. 135 [U. S. Comp. St. 1901, p. 1895]), except as this has been decided in the case of *U. S. v. One Silk Rug* (T. D. 28,779) 158 Fed. 974, the first cause of forfeiture would seem to be bad in any event. The information shows that the entry into the customhouse was made by one Charles (Constantine) S. Galanopulo, in New York; and the cause of forfeiture alleges that this entry was made by Frank S. Galanopulo, who was at all the times mentioned in Greece. If the government intended to imply that the person making the entry in New York was merely an agent, it has not so charged in the information.

As to the second cause of forfeiture, it is impossible to tell upon which one of the many sections of the Revised Statutes referred to the government really intends to rely. The claimant has demurred on the ground that nothing is charged except a conspiracy. But the language of this cause of forfeiture would seem to make out, in connection with the general statement of fact in the first part of the information, a charge under section 9, c. 407, of the act of June 10, 1890, that a false entry was made in the New York customhouse by means of a fraudulent invoice; that this false entry would deprive the United States of duty, in that a conspiracy had been entered into by which the false invoice would be fraudulently made the basis of the computation of duty, through a misstatement of the real weight of the importation, and that the case is thus brought within the decision in *One Silk Rug*, supra. The result of this would be to show an importation contrary to law, and section 3082 (U. S. Comp. St. 1901, p. 2014), might apply. The government apparently intends so to charge, but it may be doubted whether this charge would be sufficient unless the allegations make out a violation of section 9 of the customs administrative act as well, in which case section 3082 adds nothing to the cause of action.

As to the other possible grounds of forfeiture, it is unnecessary to speak at this time. They should be stated separately. But inasmuch as the allegations seem to be good upon the ground of attack by the claimant, the exceptions should be overruled on this point.

As to the third alleged ground for forfeiture, the district attorney has again united allegations which would bring the matter under dif-

ferent sections, and has attempted to call to the assistance of the first ground for forfeiture the provisions of section 2865 of the Revised Statutes, which are as follows:

"If any person shall knowingly and willfully, with intent to defraud the revenue of the United States, smuggle, or clandestinely introduce, into the United States, any goods, wares, or merchandise, subject to duty by law, and which should have been invoiced, without paying or accounting for the duty, or shall make out or pass, or attempt to pass, through the custom-house any false, forged, or fraudulent invoice, every such person, his, her, or their aiders and abettors, shall be deemed guilty of a misdemeanor, and on conviction thereof shall be fined in any sum not exceeding five thousand dollars, or imprisoned for any term of time not exceeding two years, or both, at the discretion of the court."

Under the decision in *Keck v. U. S.*, 172 U. S. 434, 19 Sup. Ct. 254, 43 L. Ed. 505, the act charged cannot be classified as smuggling nor brought within the words "clandestinely introduce."

The government has also alleged a verification of a false invoice at Calamata, Greece, and the forwarding of one of these false invoices, which were made in triplicate, to the collector of customs at New York. Section 3 of the Law of 1890 does not require these invoices to be verified. Nor is there anything in the act which would seem to bring this false verification within the provisions of section 1750 of the Revised Statutes (U. S. Comp. St. 1901, p. 1196), and the third cause of forfeiture must therefore be judged solely from the standpoint of the second part of section 2865, *supra*.

The government seems to charge the importer in Greece, in connection with all of the other matters referred to, with having unlawfully made out, passed, or attempted to pass through the customhouse a false invoice; but the allegations of the information do not show any such transaction, and in fact the charge is stated to be, in the nineteenth cause of information, that the said Frank S. Galanopulo, in making, signing, certifying, and verifying the said false and fraudulent invoice, and leaving the same with the French consul, which invoice was thereafter forwarded by the said consul to the collector of customs, and by sending the said merchandise to New York, did then and there—that is to say, at the time of sending to the port of New York—attempt to make an entry of the said merchandise by means of the said false invoice, by means whereof the United States was to be deprived of lawful duties, etc.

It might be suspected that a charge could be made upon which it would be necessary to construe section 2865 in order to see if its provisions cover the acts charged; but no such allegations are contained in the third ground of forfeiture, and the exceptions to this will therefore be sustained.

RICHARDSON v. A. C. BOSSELMAN & CO. et al.

(Circuit Court, S. D. New York. June 10, 1907.)

COPYRIGHTS (§ 70*)—ACTION TO RECOVER PENALTIES FOR INFRINGEMENT—PROCEDURE.

A writ of seizure issued in, or preliminary to, an action under Rev. St. § 4965 (U. S. Comp. St. 1901, p. 3414), to recover the penalty prescribed thereby for each copy of an infringing copyrighted publication found in the possession of the infringer is not strictly a writ of replevin, but only in the nature of such writ, and is not to be rendered inoperative by the technical provisions of a state statute.

[Ed. Note.—For other cases, see Copyrights, Dec. Dig. § 70.*]

On Motion to Vacate Writ and to Set Aside Service.

Philip J. McCork, for plaintiff.

Rudolph Marks, for defendants.

LACOMBE, Circuit Judge. The motion to vacate writ and set aside service is denied. Although "in the nature of replevin," it is not strictly a writ of replevin, and not to be rendered inoperative by the technical provision of state practice. See *American Tobacco Co. v. Werckmeister*, 146 Fed. 375, 76 C. C. A. 647.

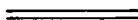

STERN et al. v. JEROME H. REMICK & CO.

(Circuit Court, S. D. New York. October 27, 1908.)

COPYRIGHTS (§ 70*)—ACTION TO RECOVER PENALTIES FOR INFRINGEMENT—PROCEDURE.

A circuit court has authority under Rev. St. § 716 (U. S. Comp. St. 1901, p. 580), to issue a writ for the seizure of infringing copies of a copyright publication alleged to be in the possession of the infringer as preliminary to an action under Rev. St. § 4965 (U. S. Comp. St. 1901, p. 3414), to recover the penalty prescribed therein for each copy found in the possession of the defendant, such writ being one necessary for the exercise of the court's jurisdiction, since under the ruling of the Supreme Court such copies must be "found" before the cause of action to recover the penalty accrues.

[Ed. Note.—For other cases, see Copyrights, Dec. Dig. § 70.*]

On Motion to Vacate Writ of Seizure.

Cohen, Creevey & Richter, for plaintiffs.

House, Grossman & Vorhaus (Charles Goldzier, of counsel), for defendant.

WARD, Circuit Judge. On or about October 12, 1908, the plaintiffs filed a petition for a writ directing the United States marshal to seize and hold under U. S. Rev. St. 4965 (U. S. Comp. St. 1901, p. 3414), certain copies of a song alleged to have been copyrighted by it. The marshal did seize, and now holds, the same.

*For other cases see same topic & § NUMBER in Dec. & Am. Digs. 1907 to date, & Rep'r Indexes

October 16, 1908, a summons was issued in an action brought by the plaintiffs against the defendant, described on the face of the summons as an "action for forfeiture of plates and copies and to recover penalties under section 4965, Rev. St. U. S. as amended." Subsequently on the same day an order to show cause why the writ of seizure should not be vacated was served by the defendant's attorneys. The defendant contends that the court had no jurisdiction to issue the writ of seizure because no action was pending at the time. Congress has prescribed no form of action appropriate for seizing copies subject to forfeiture and penalties under section 4965, but the Supreme Court has said that an action "in the nature of replevin" seems to be contemplated. *Bolles v. Outing Co.*, 175 U. S. 266, 20 Sup. Ct. 94, 44 L. Ed. 156. The common-law action of replevin could not have been contemplated because it supposes title in the plaintiff at the time of seizure, and a right in the defendant by giving a bond to retain possession of the property as his own.

The difficulty in practice has been caused by a remark of Justice Miller in *Thornton v. Schreiber*, 124 U. S. 613, 621, 8 Sup. Ct. 618, 622, 31 L. Ed. 577, to the effect that "we, however, think that the word 'found' means that there must be a time before the cause of action accrues at which they are found in the possession of the defendant." In *Falk v. Curtis Publishing Company* (C. C.) 102 Fed. 967, affirmed 107 Fed. 126, 46 C. C. A. 201, because of this remark the court below held that no cause of action arose until the seizure, and therefore a suit brought before seizure was premature. Judge Hazel followed this case in *Childs v. New York Times Co.* (C. C.) 110 Fed. 527. The general rule is that a suit is commenced when the summons is taken out. 1 Cyc. 739. But section 416 of the Code of Civil Procedure provides that an action is commenced when the summons is served. It is as follows:

"416. Action to be commenced by summons; time when court acquires jurisdiction.

"A civil action is commenced by the service of a summons. But from the time of the granting of a provisional remedy, the court acquires jurisdiction, and has control of all the subsequent proceedings. Nevertheless, jurisdiction thus acquired is conditional, and liable to be divested, in a case where the jurisdiction of the court is made dependent, by a special provision of law, upon some act to be done after the granting of the provisional remedy."

I think under section 721, Rev. St. U. S. (U. S. Comp. St. 1901, p. 581), this provision of the New York law applies to a summons issuing out of this court. If so, the practice under section 4965 is made extremely simple. Plaintiff can obtain his writ of seizure and his summons at the same time, put them both in the hands of the marshal (or he may employ a private person to serve the summons in accordance with the state practice), and direct him to serve the summons after making the seizure. If this be not so, still I think that the writ of seizure is, as held in *American Tobacco Co. v. Werckmeister*, 146 Fed. 375, 76 C. C. A. 647, one which the court is authorized to issue under section 716, Rev. St. U. S. (U. S. Comp. St. 1901, p. 580), as necessary for the exercise of its jurisdiction. This court having exclusive jurisdiction, under Rev. St. U. S. §§ 629 and 711 (U. S. Comp.

St. 1901, pp. 503, 577), of copyright cases, cannot exercise it unless the goods subject to forfeiture and penalty are seized before the cause of action arises.

That it is also agreeable to the usages and principles of law may be inferred from sections 416 and 1693 of the New York Code of Civil Procedure, although they apply to the action of replevin. The latter reads as follows:

"Where a chattel is replevied before the service of the summons, as prescribed in this article, the seizure thereof by the sheriff is regarded as equivalent to the granting of a provisional remedy, for the purpose of giving jurisdiction to the court and enabling it to control the subsequent proceedings in the action; and as equivalent to the commencement of the action, for the purpose of determining whether the plaintiff is entitled to maintain the action, or the defendant is liable thereto."

In *Acker v. Hautemann*, 27 Hun (N. Y.) 48, the General Term said:

"The action was brought to recover possession of personal property, and the effect of the neglect of the sheriff to make service of the summons was that the chattels were replevied before the service of the summons. The seizure, therefore, must be deemed as equivalent to the granting of a provisional remedy for the purpose of giving jurisdiction to the court and enabling it to control the subsequent proceedings in the action, and as equivalent to the commencement of the action for the purpose of determining whether or not the plaintiff had a right to maintain the action, as the defendant is liable thereto."

The practice followed by the plaintiffs conformed to the proceedings in *Richardson v. Bosselman*, 164 Fed. 781, in which Judge Lacombe refused to vacate the writ of seizure because it issued and the seizure was made before the summons was taken out.

Motion denied.

In re SCHLIPPENBACH, Imperial Russian Consul General.

(District Court, S. D. New York. October 27, 1908.)

EXTRADITION (§ 12*)—INTERNATIONAL—WARRANT OF ARREST.

Under Rev. St. § 5270 (U. S. Comp. St. 1901, p. 3591), which provides generally for the issuance of a warrant in extradition proceedings on a complaint under oath, a certificate of the Secretary of State that application for the extradition of the person named has been made by the foreign government is not necessary to the issuance of such warrant, even where, as in case of Russia, the treaty provides for such certificate.

[Ed. Note.—For other cases, see Extradition, Cent. Dig. § 13; Dec. Dig. § 12.*]

Extradition Proceeding. On motion to vacate warrant of arrest.

Herbert Parsons, for the motion.

Frederic R. Coudert, opposed.

HOLT, District Judge. This is a motion to vacate a warrant of arrest in an extradition proceeding. Before that warrant was issued, the Secretary of State had dismissed a previous proceeding for the

*For other cases see same topic & § NUMBER in Dec. & Am. Digs. 1907 to date, & Rep'r Indexes

extradition of the same prisoner, without prejudice to the right of the demanding government to initiate a new proceeding. Such new proceeding was initiated by an affidavit of the Consul General of Russia at New York, charging Pouren in detail with the crimes of arson, burglary, attempt to commit murder, and murder.

The grounds upon which this motion is based are that no certificate issued by the Secretary of State of the United States, certifying that a request had been made by the imperial government of Russia for the arrest of Pouren, was produced before me upon issuing the warrant, and that no such certificate in fact was issued after the dismissal of the first proceeding. It is admitted that there was such a certificate issued at the beginning of the first proceeding. The evidence shows that after the first proceeding was dismissed an application was made to the Department of State by Mr. Kroupensky, charge d'affaires ad interim of Russia, for a new certificate for the arrest of Pouren, and that Mr. Adee, the Assistant Secretary of State, then informed Mr. Kroupensky that a new certificate for the arrest of Pouren was not necessary. A certificate having been duly issued in the original proceeding, and the Secretary of State having expressly provided that that proceeding was dismissed without prejudice to the right of the demanding government to initiate a new proceeding, I think that no new certificate was necessary, and that, if any new certificate were necessary, the provision that the then pending proceeding was dismissed without prejudice to the right of the demanding government to initiate a new proceeding was in itself substantially a certificate, or the equivalent of a certificate.

Moreover, it is well settled that no such certificate is necessary. Although the treaty with Russia provides for such a certificate, section 5270 of the Revised Statutes (U. S. Comp. St. 1901, p. 3591), provides generally that a warrant of extradition may be issued upon a complaint under oath, and the United States Supreme Court has held, in the case of *Grin v. Shine*, 187 U. S. 181, 23 Sup. Ct. 98, 47 L. Ed. 130, a case arising under the Russian treaty, that:

"While article 7 undoubtedly contemplates a prior certificate of the Secretary of State, the language of the article is merely permissive, and does not compel the production of such certificate before the warrant can be issued."

The motion to vacate the warrant is denied, and the matter is referred to Samuel M. Hitchcock, United States commissioner in extradition proceedings, to proceed with the hearing and take what further action is necessary in the case.

CHICAGO, R. I. & P. RY. CO. v. STEPP et al.

(Circuit Court of Appeals, Eighth Circuit. November 7, 1908.)

No. 2,725.

1. RAILROADS (§ 400*)—ACTIONS—QUESTIONS FOR JURY—SIGNALS.

In an action for the killing or injury of a person by a railroad train at a station, where there is testimony of apparently credible witnesses who had an opportunity to observe the fact that the bell or whistle on the engine was not sounded, although such testimony is necessarily negative and although it may be contradicted by positive testimony, the question is one for the jury.

[Ed. Note.—For other cases, see Railroads, Cent. Dig. § 1373; Dec. Dig. § 400.*]

Injuries to persons at stations, see note to *New England R. Co. v. Hyde*, 41 C. C. A. 550.]

2. RAILROADS (§ 400*)—ACTION FOR INJURY TO PERSON AT STATION—QUESTIONS FOR JURY—RATE OF SPEED.

Whether the running of a railroad train through station grounds at a certain rate of speed constituted negligence on the part of the company depends upon the surrounding circumstances, and, when in issue in an action for the killing of a person on the track, is a question for the jury.

[Ed. Note.—For other cases, see Railroads, Cent. Dig. § 1374; Dec. Dig. § 400.*]

3. RAILROADS (§ 261*)—COMPANIES LIABLE FOR INJURIES—JOINT USE OF TRACK.

The fact that a railroad train owned by one company and operated by its servants, while being run over a track used jointly with another company, is subject to the rules and regulations of the latter company and the orders of its train dispatcher, does not relieve the owner from liability for an injury to a person by such train resulting from its negligent operation.

[Ed. Note.—For other cases, see Railroads, Cent. Dig. §§ 824-827; Dec. Dig. § 261.*]

4. CARRIERS (§ 347*)—INJURIES TO PERSONS AT STATION—CONTRIBUTORY NEGLIGENCE.

A passenger before crossing a track at a railroad station while taking or leaving a train is not required, as a matter of law, to look and listen for approaching trains, but is simply required to exercise reasonable care in the light of all the circumstances existing at the time, and whether, he exercises that care is a question of fact for the jury.

[Ed. Note.—For other cases, see Carriers, Cent. Dig. §§ 1363-1366, 1385-1397, 1402; Dec. Dig. § 347.*]

5. CARRIERS (§ 306*)—INJURIES TO PERSONS AT STATION—CARE REQUIRED—JOINT USE OF STATION.

A railroad company which entered into a contract entitling it to use station premises jointly with other companies came under the same duty as to passengers using the premises in connection with the other roads that it owed to its own passengers, and was required to operate its trains with the same due regard for their safety.

[Ed. Note.—For other cases, see Carriers, Cent. Dig. §§ 1249-1251; Dec. Dig. § 306.*]

6. RAILROADS (§ 372*)—INJURY TO PERSON AT STATION—LIABILITY—NEGLIGENT OPERATION OF TRAIN.

A railroad company which ran a train past a station at which another train was receiving and discharging passengers at a rate of speed which in itself constituted negligence under the circumstances is liable for an

*For other cases see same topic & § NUMBER in Dec. & Am. Digs. 1907 to date, & Rep'r Indexes 164 F.—50

injury to a person of which such negligence was the proximate cause, whether or not the particular injury that resulted could have been foreseen.

[Ed. Note.—For other cases, see Railroads, Cent. Dig. §§ 1267-1273; Dec. Dig. § 372.*]

7. CARRIERS (§ 238*)—INJURY TO PERSON AT STATION—ACTIONS—QUESTIONS FOR JURY.

An intending passenger walked from the platform of a railroad station across one track for the purpose of taking a train of a company which used the station jointly with defendant, then standing upon the second track and about to start. He attempted to enter on the side next to the station, as was customary, as the train started, but the cars were vestibuled and the doors on that side closed, and being unable to enter he turned to go back to the station to wait for another train, when he was struck and killed by a train of defendant on the intervening track which was running at a speed of 40 or 50 miles an hour. *Held*, in an action to recover for his death, that he was a passenger with all the rights of one on the station grounds, and that the questions of defendant's negligence in the manner of running its train and of the contributory negligence of the deceased were properly submitted to the jury.

[Ed. Note.—For other cases, see Carriers, Cent. Dig. § 973; Dec. Dig. § 238.*]

In Error to the Circuit Court of the United States for the Western District of Missouri.

For opinion below, see 151 Fed. 908.

On March 14, 1906, James M. Stepp, the father of the plaintiffs below, was struck and instantly killed by a train of the Chicago, Rock Island & Pacific Railway Company, the plaintiff in error, on the depot platform at Randolph, Mo., a suburban station accommodating 400 or 500 people, and located seven miles east of the Union Depot in Kansas City. The trains of three railway systems, the Wabash Railway Company, the Chicago, Burlington & Quincy Railway Company, and the Chicago, Rock Island & Pacific Railway Company, are operated past this station, jointly, over two main tracks. These tracks run east and west. The north track, owned by the Burlington Company, was used for west-bound trains, and the south track, owned by the Wabash Company, was used for east-bound trains. The plaintiff in error did not own either of the tracks, but, under the terms of a running agreement with the Burlington Company, had the right to operate its trains between Kansas City and Cameron Junction over the tracks of the Burlington Company, and over the joint track at Randolph. While using these tracks Rock Island trains were controlled by the rules and regulations of the Burlington Company, and were subject to the direction of its train dispatchers and other agents having control of the movement of trains. The station at Randolph is situated immediately south of the tracks. In front of it, and extending in an easterly and westerly direction parallel with the tracks and level therewith, was an ordinary depot platform 186 feet long and 8 feet wide. Immediately north of the north track, and level therewith, was an open platform, without cover of any kind, 96 feet long and 6 feet wide. Extending from the depot platform due north across the tracks, and across two switch tracks north of the main track, was a narrow platform or walk 15 feet wide, level with the tracks, and connecting the two platforms. On either side of this walk the space between the two platforms was filled with cinders flush with the track, and passengers going to and from trains were accustomed to walk over these cinders the same as upon the narrow walk just referred to. The space between the main tracks was 10 feet, about 4 feet of which would be covered by the overlapping of cars. Notwithstanding the north platform, passengers were accustomed to get on and off trains on the north track on the south side. The deceased was a farmer living a mile or more east of Randolph. On the morning of the accident he had sent his son to Kansas City with a load of hogs

*For other cases see same topic & § NUMBER in Dec. & Am. Digs. 1907 to date, & Rep'r Indexes

to be sold on the market at the stockyards there. He himself intended to go to the city on the Burlington train which passed Randolph about 7:30 in the morning, to meet his son and look after the sale. He approached the station on a road from the east running parallel to and near the tracks. This road crosses the tracks at a point about 380 feet east of the center of the depot platform. When he reached that point he continued westward along a well-beaten cinder pathway south of the main track to the east end of the platform immediately in front of the depot and south of the tracks. As he reached the depot the west-bound Burlington train, which he intended to take, pulled in and stopped. It consisted of six coaches, and was about a block and a half long. The locomotive was at a point between 70 and 100 feet west of the depot. It was emitting smoke and steam. The morning was misty, and the wind in the northeast, so that the smoke and steam from the locomotive was blown down across the south track. On this track a Rock Island train was approaching from the west. Mr. Stepp crossed the south main track from the south platform, and endeavored to get aboard the Burlington train. He had the money to pay his fare, and intended in good faith to become a passenger. He found that he was at a vestibule car, and the door was closed. He then hurried forward to the next car platform, but this, too, was vestibuled and closed. The train was then moving out. He seized hold of the handholds and tried to get in while the train was in motion. The conductor or some other employé of the road was on the car platform, and some conversation passed between him and Mr. Stepp, but there is no trustworthy evidence as to what was said. Then Mr. Stepp abandoned his effort to gain admittance, and turned to go south to the station to wait for the next train. The second step brought him upon the south track, where he was struck by the Rock Island train, which was running through the depot grounds at a speed of from 40 to 50 miles an hour. The railroad track on which this train approached the station was straight, and the view along it unobstructed by permanent objects for a distance of a mile and a half or two miles.

The plaintiff charges the defendant with negligence in two particulars: First, that no bell was rung or whistle sounded by its train as it approached the station; and, second, that the train was running at a negligent rate of speed, not only in violation of law, but in violation of the rules of the company. At the close of all the evidence the defendant moved the court to direct a verdict in its favor. The refusal to grant that motion constitutes the only error assigned in this court.

Paul E. Walker (M. A. Low, on the brief), for plaintiff in error.

W. C. Scarritt (E. L. Scarritt and Elliott H. Jones, on the brief), for defendants in error.

Before HOOK and ADAMS, Circuit Judges, and AMIDON, District Judge.

AMIDON, District Judge (after stating the facts as above). There is the usual conflict in the evidence as to whether the signals were given, and in the briefs there is the familiar discussion of the relative weight of negative and positive evidence. In following out this distinction courts have sometimes overlooked the fundamental fact that in such a case the plaintiff is necessarily confined to negative evidence. If such evidence is unworthy of belief simply because it is negative, then the plaintiff must nearly always fail. The fact which he has to prove is negative, viz., that the bell was not rung or the whistle sounded; and the only way that fact can be established is to bring witnesses who were so situated that they would have heard the signals if they had been given, and who testify that they did not hear them. Such evidence, of course, ranges through all degrees of credibility. If the witness had been accustomed to hear

such signals frequently so that their impression would be deadened by habit, his testimony that he did not hear them would have no weight as against trustworthy affirmative evidence that the signals were given, unless the witness was able to testify to some circumstance showing that his attention was specially directed to the subject on the occasion in question. Again, if a witness situated so he could hear the signals, and of such experience that he would have been likely to notice them if they had been given, testifies that he did not hear them, the credibility of his evidence is for the jury, unless there is proof that his attention at the time was absorbed in some other matter. Finally, if the attention of a witness is especially directed to the train and its signals, and at the time a distinct impression is made upon his mind that the signals are not given, his testimony is in every particular as trustworthy, though negative, as would be the evidence of another witness similarly situated affirming that the signals were given. In either case the truth or falsity of the evidence depends upon the truthworthiness of the sense of hearing and the honesty of the witness testifying to the fact. It is likewise true that affirmative evidence on such a subject does not prove the fact simply because it is affirmative. It is subject to all the infirmities, bias, and interest to which all human testimony is subject. Such evidence is also frequently given by trainmen, who are accustomed to give the signals and to hear them. It is their habit to give such signals on approaching stations and highway crossings. The mere habit is likely to blur the memory of the fact. But after an accident has occurred nothing is more natural than for the memory of a trainman, unconsciously and by a well-recognized mental illusion, to raise a recollection of the giving of the signal, out of his previous habitual practice. That the signal was given springs up in his mind, not by a process of recollection, but as the result of a long-continued habit. This truth is well illustrated in the present case. The engineer of the Burlington train knew nothing of the accident at the time it occurred. He did not hear of it until some 25 minutes later, after reaching Kansas City. In the meantime he had necessarily heard numerous locomotive bells. His opportunity to observe the ringing of the bell on the Rock Island train was meager. His own train was just starting up, with the attendant noises of his locomotive. The Rock Island train swept by him at a speed of from 40 to 50 miles an hour. Still he testifies that looking through the cab window opposite him he saw the bell on the Rock Island locomotive swinging as it passed his cab. No circumstance is mentioned why this fact, which would be a usual occurrence in passing locomotives, and would have ordinarily made no impression upon his mind, did so impress his attention on the occasion in question that he was able to recall the fact after the accident. Affirmative evidence subject to so many possibilities of error is, of course, no more trustworthy than negative evidence. In the present case there were seven witnesses who testified that the signals were not given. Some of them were in a position especially favorable for observing the fact if it had occurred, and two of them at least had their attention directed to the

train as it approached the station. In opposition to this evidence two witnesses on behalf of the defendant testified that the bell was rung. One was the engineer of the Burlington train, and the other was a witness standing in the station who said that he noticed that the Rock Island bell was swinging as the train passed by, although at that very time his eyes were also fixed upon Mr. Stepp's peril and death. Such a conflict of evidence surely was for the consideration of the jury. As to the sounding of the whistle for the station, the conflict in the evidence is much more favorable to the defendant. Witnesses testified to circumstances which make it altogether probable that the station whistle was sounded. But such a warning of the approach of a train to a station where another passenger train is standing, and to and from which passengers are likely to be moving, would be a wholly inadequate warning of the danger. The attention of passengers under such circumstances is diverted by the necessary confusion which is always present on such an occasion, and a train which should pass rapidly through station grounds without giving a constant warning of its approach by the ringing of the locomotive bell would be manifestly guilty of negligence. We are, therefore, satisfied that the trial court committed no error in submitting this issue to the jury.

It was also for the jury to say whether the defendant was guilty of negligence in running its train past the station at the high rate of speed which is admitted. Our attention is called to numerous cases in which it is stated that railroads are themselves to be the judges of the speed at which they will run their trains, and that their judgment as to the proper requirements on this subject cannot, as a matter of law, be held to constitute negligence. In the cases in which the language was used the situation involved the speed of trains in the open country, and as to those situations the language was entirely proper. But negligence depends upon circumstances. It is too plain for controversy that railroads cannot be given an unrestricted discretion as to the speed at which they will run trains through station grounds. At such points railroads must operate their road with due regard to the safety of the public, and, if the matter were to be determined as a matter of law, we should have no hesitancy in saying that it was plainly negligent for the defendant to run its train past the station at Randolph, under the conditions existing there at the time, at the speed of 40 miles an hour. If such a speed is necessary, then the company was bound to safeguard the public by gates and signal men. Rule 10 of the Burlington Company was binding upon this train, and clearly forbade such a speed. It reads as follows:

"When passenger trains are receiving or discharging passengers at stations on double track or at points where they meet or pass other trains, all trains must approach under complete control."

It is seriously urged that if the trainmen in charge of the Rock Island train were guilty of negligence, either in the speed of the train or in omitting to give signals, the defendant cannot be held liable for their negligence, because while running upon these joint tracks they were subject to the rules and regulations and the train

dispatchers of the Burlington road. As to this contention it may first be answered that the speed of the train was the customary speed of all such trains at that station, and must therefore, be held to be the act of the defendant, and not of its agents. We would not, however, wish to rest our decision upon that ground alone. We are clearly of the opinion that the circumstances put forward to exempt the defendant from liability cannot be given any such effect. The fact that the train was run subject to the rules and regulations of the Burlington Company, and under the direction of its train dispatchers, did not make the Rock Island train a Burlington train, or its trainmen the servants of the Burlington road. This requirement grew out of the fact that two roads were using the same track at the same time. It was necessary that there should be a single authority to control the movement of the trains in order to secure safety in the operation of the road. That was the entire scope and effect of this requirement. The train was at all times a Rock Island train, and the employes upon it were its employes. That company had purchased the right by contract to run its trains over the track in question. The requirement that the employes should act under the rules and train dispatchers of the Burlington was simply an arrangement whereby they could efficiently and safely perform their service for the Rock Island Company. The authority mainly relied upon by the defendant in support of its position is *Atwood v. Chicago, Rock Island & Pacific Ry. Co.* (C. C.) 72 Fed. 447. We cannot approve of that decision in its holding as to the liability of the Rock Island Company upon the facts there disclosed. We think the learned judge who rendered the decision attached undue importance to the fact that the Rock Island trainmen there were subject to the rules and regulations and the train dispatcher of another company. Who has the right to control the conduct of an employe, is perhaps the most important circumstance in deciding the question as to whose servant he is. It is decisive in cases to which it has been most frequently applied, namely, where the servant is at the same time in the general employment of one person, and the special employment of another. Such was the case of *Donovan v. Construction Syndicate* (1893) 1 Q. B. 629. There the defendants, who were the owners of a crane, lent it to another company, with an operator in their employ to run it. While using the crane in the service of the hirers, the operator was subject to their exclusive control and direction. For this reason it was held that while engaged on the machine for them he was their servant, and not the servant of the owners, although he was hired and paid by them. Chief Justice Cockburn, in *Rourke v. Colliery Co.*, 2 C. P. Div. 205, states accurately both the rule and the circumstances to which it is applicable, as follows:

"When one person lends his servant to another for a particular employment, the servant, for anything done in that particular employment, must be dealt with as the servant of the man to whom he is lent, although he remains the general servant of the person who lent him."

In order to render one person the servant of another, however, he must be in some way, either generally or specially, actually in the

service of that other—working for him. Judge Taft, speaking for the Court of Appeals for the Sixth Circuit, in *Byrne v. Kansas City, Ft. Scott & Memphis Railway Co.*, 61 Fed. 605, 607, 9 C. C. A. 666, 24 L. R. A. 693, brings both requirements together when he asks in regard to an employé: "Whose work was the servant doing?" and "Under whose control was he doing it?" The employés in charge of the Rock Island train were not working for the Burlington Company; it did not employ or have any right to discharge them; it owned no part of the train upon which they were working; and, finally, it had no interest, either by way of contract or ownership, in the service which they were performing. They were not, therefore, its servants, notwithstanding, for purposes of safety to its own trains, they were subject to its rules and direction. The duty to make reasonable rules and regulations, and to exercise reasonable supervision by means of train dispatchers, was the positive duty of the Rock Island Company—a duty which it owed both to its employés and the public. It could not delegate that duty to another, and, when by agreement it placed its trains under the rules and regulations and the train dispatchers of the Burlington Company, it still remained as responsible for those rules, regulations, and directions as it would have been if they had been made or given by itself. Again, it would be a dangerous doctrine to permit a railroad company, when charged with wrongful conduct, to escape liability upon the ground that the act was done pursuant to the rules and directions of another company to which it had by previous agreement delegated authority. Such a holding would permit the direction of a third party to be set up as justification for a tort in its most vicious form. It might be that if the Burlington Company had, either by its rules or its train dispatcher, directed the doing of the very act complained of, it, as well as the Rock Island Company, would be liable in damages; but surely the Rock Island Company could not be heard to plead those facts in exoneration of its own wrong.

The case of *Smith v. St. Louis & San Francisco Railway Co.*, 85 Mo. 418, 55 Am. Rep. 380, when fully examined, will be found to rest upon different and satisfactory grounds. There the Missouri Pacific Road entered into an agreement with the defendant in that case by which the former agreed to transport all of the passenger trains of the latter passing between the Union Station at St. Louis and the substation of Franklin, using for that purpose its own locomotive and crew, the San Francisco road simply furnishing the cars and the brakeman and conductor. The San Francisco Company was to do no business between the stations mentioned, or intermediate stations. The plaintiff bought a ticket of the Missouri Pacific Company to ride from the Union Station in St. Louis to Webster, an intermediate point, and took passage on a car owned by the San Francisco Company, and hauled by the Missouri Pacific under this agreement. The circumstances of the accident are stated in the opinion as follows:

"The train arrived at Webster about 10 o'clock at night, and stopped at the depot for passengers to get on and off. It was a dark night, and the depot was not lighted, and in the act of getting off, or immediately after getting off, Smith fell between two of the cars, and at that moment the train started, and passing over him inflicted injuries of which he died soon after,

and his widow instituted this suit against the defendant to recover damages. The negligence alleged is that the train did not stop long enough to allow the deceased reasonable time to alight, and that the depot was not lighted."

Under all these circumstances it is entirely plain that the Missouri Pacific Railroad Company, and not the San Francisco Company, was responsible. Smith was its passenger. It was hauling the train and controlling its movements, and was entitled to all its earnings while passing over its road. It is not necessary to recount the circumstances of the present case to show that it is controlled by considerations fundamentally different from the case there involved.

The defense that the Burlington road, and not the Rock Island, was responsible for the negligence complained of, was in no way embodied in the answer, nor was it presented to the trial court. On the contrary, the answer admits that the defendant "was at all the times mentioned in the petition engaged in operating a railroad in the state of Missouri." It further admits that it "and other railroad companies were accustomed to and did run, conduct, operate, and manage cars and trains of cars" over the track in question, and admits "that the said James M. Stepp was struck and killed by a locomotive engine of this defendant," and admits that defendant, Louis Collier, was upon said engine, and operating the same "as the agent of this defendant, at said time and place." In the face of these admissions, even if there were merit in the defense itself, the defendant is precluded from urging it.

Was the deceased guilty of contributory negligence in failing to look and listen before attempting to cross the track upon which he met his death? It is conceded that he took neither of these precautions. If, however, he was entitled to the rights of a passenger while on the platform, he was not required to do so. It is now the settled rule of the federal courts that passengers using station premises for the purpose of taking or leaving trains have a right to assume that the place is one of safety, and to act upon that assumption. While they are not absolved from all care, they are not required to exercise that high degree of care which the law imposes upon travelers when approaching the intersection of a highway and a railroad. The traveler upon the highway has no right to assume that the railroad is a place of safety, or that trains will not be run over it while he is attempting to pass. On the contrary, the rule has been repeatedly declared that such a crossing is a place of danger, and that the traveler must approach it with the knowledge that the company may at any time be moving trains over its road. This is the ground of the difference between the rule as to a passenger while upon station grounds and a traveler upon the highway. The one has the right to believe that the place which he is using is one of safety, while the other is bound to know that the place which he is approaching is one of imminent danger. Upon the basis of this difference the rule is now firmly established that a passenger, before crossing a track while taking or leaving a train, is not required, as a matter of law, to look and listen for approaching trains. He is simply required to exercise reasonable care in the light of all the circumstances existing at the time, and

whether he exercises that care is a question of fact for the jury. *Warner v. Baltimore & Ohio R. R. Co.*, 168 U. S. 339, 18 Sup. Ct. 68, 42 L. Ed. 491; *Alabama & Great Southern Ry. Co. v. Coggins*, 88 Fed. 455, 32 C. C. A. 1; *Graven v. MacLeod*, 92 Fed. 846, 35 C. C. A. 47; *Chesapeake & Ohio Ry. Co. v. King*, 99 Fed. 251, 40 C. C. A. 432, 49 L. R. A. 102. This rule is based upon the soundest considerations of public policy. While taking or leaving a train, the attention of passengers is necessarily absorbed in a multitude of considerations which make it impossible for them to exercise a careful watchfulness for approaching trains. There is usually considerable noise at such places. Frequently there is the meeting or leaving of friends. As a rule there is also haste and confusion. These and many other familiar circumstances confuse the mind, and render watchfulness impossible. The situation of Mr. Stepp is itself an impressive illustration. He arrived at the station a little late, and hastened to take the train. He rushed from one platform to another to enter, but found all entrance to the train barred. With his mind bewildered by this experience, he turned to go to the depot to wait for the next train, and was immediately struck and killed. All the circumstances mentioned were such as would throw the ordinary person off his guard, and to hold that one so situated ought to exercise the same care as a person approaching a highway crossing would be to confound situations that are fundamentally different and encourage carriers to disregard the safety of the public. The defendant attempts to withdraw the present case from the rule we have been considering upon the ground that Mr. Stepp was not a passenger as to the Rock Island Company at the time of the injury, and relies upon *Chattanooga, R. & S. Ry. Co. v. Downs*, 106 Fed. 641, 45 C. C. A. 511, *McCann v. Chicago, Milwaukee & St. P. Ry. Co.*, 105 Fed. 480, 44 C. C. A. 566, and *Elliott v. Chicago, Milwaukee & St. P. Ry. Co.*, 150 U. S. 245, 14 Sup. Ct. 85, 37 L. Ed. 1068, in which the courts have declined to extend the exemption in favor of passengers to employes or licensees. In our judgment Mr. Stepp had the rights of a passenger not only as to the Burlington road upon which he was intending to take passage, but as to all carriers operating trains through the station grounds. When the defendant entered into a contract entitling it to use the depot premises jointly with the other roads, it came under the same duty as to passengers using the premises in connection with other roads that it owed to its own passengers. Rule 10, already quoted, imposed that duty upon it. It was bound to know that passengers upon other roads would be using the premises, and to operate its trains accordingly. Mr. Stepp also had a right to assume, while properly using the depot premises, that the defendant would discharge its duty in this respect, and that no train would be driven over its tracks at a speed of 40 miles an hour at a time when passengers to or from the Burlington train were upon the platform. His right did not grow out of the contract of carriage, save only as that contract gave him the right to be upon the premises. Being there rightfully as a good-faith passenger, he had the right to assume that all carriers using the premises would have the same regard for his safety as the carrier upon whose road he was seeking

passage. Having failed to secure entrance to the train, he did not cease to be a passenger, but had all the rights of a passenger while returning to the depot for the purpose of waiting for the next train. At the time of his injury, therefore, he was clearly within the class which is exempt from the rule as to looking and listening for other trains, and his failure to take that precaution cannot be assigned as negligence on his part as a matter of law. The trial court, in a charge to which no exceptions were reserved, submitted to the jury the question whether Mr. Stepp was in the exercise of reasonable care. It would have been manifest error for it to withdraw the case from the jury and declare as a matter of law that the deceased was guilty of contributory negligence.

Deceased was not negligent in attempting to enter the train from the south side. The evidence shows that it was a regular practice of the traveling public to do this. No sign indicated that the north platform must be used in taking west-bound trains, nor did any employé point out that as the proper course. The construction of the depot ground afforded the only indication of the proper approach to trains, and that was quite consistent with the course adopted. The station was situated south of the track. That was the place where passengers were compelled to purchase their tickets, and where they would naturally wait for trains to pull in to the station and stop before attempting to take passage. It would have been unreasonable to expect the traveling public on a misty morning like the morning in question to take a stand upon the open platform and wait for an incoming train. There is no evidence that Mr. Stepp was aware that the cars were vestibuled and could be entered only from the north side. His conduct clearly indicates a different belief on his part.

Finally, it is insisted that the defendant ought not to be held liable because its engineer with an open track before him could not anticipate that deceased would step on the track immediately in front of the train. That, however, is not the test of defendant's liability. Its conduct in running its train past the station at 40 miles an hour while another passenger train was there receiving and discharging passengers was negligent, and the death of Mr. Stepp was the direct and proximate result of that negligence. The defendant is liable whether it could have foreseen the actual consequence of its negligence or not. The distinction made by Judge Mitchell on this subject in *Christianson v. Chicago, St. P., M. & O. Ry. Co.*, 67 Minn. 94, 69 N. W. 640, is clear and sound. Of a similar contention he said:

"The doctrine contended for by counsel would establish practically the same rule of damages resulting from tort as is applied to damages resulting from breach of contract, under the familiar doctrine of *Hadley v. Baxendale*, 9 Exch. 341. This mode of stating the law is misleading, if not positively inaccurate. It confounds and mixes the definition of 'negligence' with that of 'proximate cause.' What a man may reasonably anticipate is important, and may be decisive in determining whether an act is negligent, but is not at all decisive in determining whether that act is the proximate cause of an injury which ensues. If a person has no reasonable ground to anticipate that a particular act would or might result in an injury to anybody then, of course, the act would not be negligent at all; but if the act itself is negligent, then the person guilty of it is equally liable for all its natural and proximate con-

sequences, whether he could have foreseen them or not. Otherwise expressed, the law is that if the act is one which the party ought, in the exercise of ordinary care, to have anticipated was liable to result in injury to others, then he is liable for any injury proximately resulting from it, although he could not have anticipated the particular injury which did happen. Consequences which follow in unbroken sequence, without an intervening efficient cause, from the original negligent act, are natural and proximate; and for such consequences the original wrongdoer is responsible, even though he could not have foreseen the particular results which did follow. *Bevan*, Neg. p. 85 (3d Ed.); *Hill v. Winsor*, 118 Mass. 251; *Smith v. Railway Co.*, L. R. 6 C. P. 14. For citation of cases on this question, see 16 Am. & Eng. Enc. Law, p. 436 et seq.; also *Shear. & R. Neg.* § 28 et seq."

Lord Justice Blackburn stated the same rule tersely in the leading case of *Smith v. London & Southwestern Ry. Co.*, L. R. 6 C. P. 14:

"What the defendants might reasonably anticipate is only material with reference to the question whether the defendants were negligent or not, and cannot alter their liability if they were guilty of negligence."

On all its issues this case is one eminently proper for the decision of a jury. It was submitted on a charge to which no exception was reserved, and the judgment in favor of the plaintiffs must be affirmed.

WESTHUS et al. v. UNION TRUST CO. OF ST. LOUIS.

(Circuit Court of Appeals, Eighth Circuit. November 4, 1908.)

No. 2,654.

1. INTERNAL REVENUE (§ 8*)—LEGACY TAX—WAR REVENUE ACTS—CONSTRUCTION—"IMPOSED."

The war revenue act of June 13, 1898, c. 448, §§ 29, 30, 30 Stat. 464, 465, as amended by Act March 2, 1901, c. 806, §§ 10, 11, 31 Stat. 946, 948 (U. S. Comp. St. 1901, pp. 2307, 2308), provided for a tax on legacies to become due and payable in one year after the death of the testator and to be a lien and charge on his property for 20 years. Such provisions were repealed by Act April 12, 1902, c. 500, §§ 7, 8, 32 Stat. 97 (U. S. Comp. St. Supp. 1907, p. 649), with a saving clause as to all taxes imposed thereby prior to July 1, 1902, when the repeal took effect. Act June 27, 1902, c. 1160, § 3, 32 Stat. 406 (U. S. Comp. St. Supp. 1907, p. 652), prohibited the further assessment or imposition of any tax under said act "upon or in respect of any contingent beneficial interest which shall not become absolutely vested in possession or enjoyment" prior to July 1, 1902, and required the refunding of taxes previously collected on any such interests. *Held*, that where a testator who died in December, 1901, bequeathed a share of his residuary estate in trust, the income to be paid to a son during his life, the life estate of the son in the income of the trust property became absolutely vested in enjoyment at once on the death of the testator, and subject to the tax; that the tax was "imposed" by the statute itself at the time of such vesting without reference to the time when it became due and payable, or to any act of assessment by the internal revenue officers, which was merely an administrative detail necessary to fix the amount but not affecting the time when the tax was imposed or became a lien.

[Ed. Note.—For other cases, see Internal Revenue, Cent. Dig. §§ 11, 12; Dec. Dig. § 8.*]

*For other cases see same topic & § NUMBER in Dec. & Am. Digs. 1907 to date, & Rep'r Indexes

2. TAXATION (§ 508*)—LIEN OF TAX—TIME OF TAKING EFFECT.

The time when a tax becomes due and payable under a statute does not necessarily fix the time when it becomes a lien.

[Ed. Note.—For other cases, see Taxation, Cent. Dig. § 942; Dec. Dig. § 508.*]

In Error to the Circuit Court of the United States for the Eastern District of Missouri.

Henry W. Blodgett, U. S. Atty., and Truman P. Young, Asst. U. S. Atty., for the plaintiffs in error.

S. L. Swarts (Montague Lyon, on the brief), for the defendant in error.

Before HOOK and ADAMS, Circuit Judges, and CARLAND, District Judge.

HOOK, Circuit Judge. This was an action by the trust company, as executor and trustee under the will of George A. Madill, deceased, to recover of the collector of internal revenue a tax imposed in respect of a legacy and exacted by him pursuant to the war revenue act of 1898, and paid by the trust company under protest. Judgment went against the collector in the trial court, and this writ of error was obtained to review it.

Briefly stated, the facts upon which the government required the payment of the tax are as follows: George A. Madill of St. Louis, Mo., died December 11, 1901, leaving a will whereby, after the payment of his debts and certain specific legacies, he bequeathed all his property to the trust company in trust, with direction that the net income of the trust estate, after a deduction not material here, should be divided into three equal parts called A, B, and C respectively. We have only to do with part C. The will provided that the trust company should pay the net income represented by part C to the testator's son, Charles A. Madill, at least semiannually during his lifetime, with remainders after his death to other persons upon various contingencies. The will denied Charles A. Madill all right or power to anticipate his portion of the income, or to sell, pledge, hypothecate, or otherwise incumber the same before the trust company had actually paid it to him. There was like denial of control over the principal or corpus of the trust property; and neither income nor corpus was to be subject to the payment of his debts. The trust company made its final settlement and was discharged as executor April 6, 1904. It had previously, in April, 1902, about four months after the death of the testator, paid to Charles A. Madill on account of his legacy the sum of \$2,000. In January, 1905, the government exacted the payment of the tax in controversy in respect of the life estate of Charles A. Madill in the income of the trust property.

The statutes bearing on the case are: Sections 29 and 30 of the Act of June 13, 1898, c. 448, 30 Stat. 464, 465 (U. S. Comp. St. 1901, pp. 2307, 2308) popularly known as the "War Revenue Act"; section 11 of the act of March 2, 1901, c. 806, 31 Stat. 948 (U. S. Comp. St. 1901, p. 2308); section 7, 8, and 11 of the act of April 12, 1902, c. 500,

*For other cases see same topic & § NUMBER in Dec. & Am. Digs. 1907 to date, & Rep'r Indexes

32 Stat. 97, 99 (U. S. Comp. St. Supp. 1907, pp. 649-652); and section 3 of the act of June 27, 1902, c. 1160, 32 Stat. 406 (U. S. Comp. St. Supp. 1907, p. 652). The tax was prescribed by section 29, and the method of collection by section 30, of the act of 1898. The tax was to remain a lien and charge upon the property of the testator for 20 years unless sooner paid. The act of 1901, amendatory of the prior one, provided that the tax should be due and payable in one year after the death of the testator, and be a lien and charge upon his property for 20 years unless sooner paid. The act of April 12, 1902, repealed those provisions of the acts of 1898 and 1901 with a saving clause as to all taxes that had been "imposed" before July 1, 1902, that being the day the repeal took effect. The lien of all prior imposed taxes and the machinery for collecting them was preserved. The act of June 27, 1902, provided for the refunding of taxes that had been collected on account of contingent beneficial interests which had not become vested in possession or enjoyment prior to July 1, 1902, and forbade the imposition of such taxes in the future.

Upon the facts recited and laws referred to these questions arise: (1) Was the interest of Charles A. Madill in the income of the trust estate a contingent one not vested in enjoyment, and therefore, under the act of June 27, 1902, exempt from the tax? (2) When was the tax "imposed"? Was it automatically "imposed" by force of the statute at the time of the death of the testator and the coming into existence of the conditions upon which it operated, or was there no "imposition" of the tax until it became due and payable, to wit, a year after the testator's death? If the former, the tax was imposed December 11, 1901, and therefore survived the repealing act which took effect July 1, 1902. If the latter, it was not imposed before December 11, 1902, and fell with the act that authorized it. More briefly stated, the questions are: Was the legacy vested in enjoyment? When, under the acts of Congress, is the tax imposed in respect of a legacy vested in possession or enjoyment? It should at once be conceded that the tax is not imposed, does not come into existence, until there is a beneficial vesting of the legacy either in possession or in enjoyment, but the second of these questions proceeds upon the assumption there has been such a vesting, and then inquires: When, as to such a legacy, is the tax imposed? We apprehend the failure to observe that these questions are quite distinct has led to conclusions at variance with those we have reached.

We think the bequest to Charles A. Madill was absolutely vested in enjoyment at the death of the testator. The right of the legatee to the enjoyment of the income was not postponed to the end of a precedent estate, nor was it made to depend upon the happening of any contingency or uncertain event. A present and immediate right passed to him, not subject to divestment short of his death. The interest which passed by the will and in respect of which the tax was imposed was an ordinary life estate in the income of property held in trust, and the beneficiary was a person in being. The intervention of a trustee between the legatee and the physical handling of the corpus of the estate is unimportant in this connection. True, the precise amount of the income depended upon the amount or value of the

corpus of the trust property, the definite ascertainment of which might have to await the payment of debts and the preparation of schedules, but such an uncertainty no more makes a bequest of income contingent than does the fluctuation of rates of interest upon the invested funds of the trust estate. The income bequeathed began to accrue from the day the testator died. In determining the character of a bequest, whether contingent or vested, whether immediately to be enjoyed or the enjoyment of which is postponed, regard should be had to the terms of the will evidencing the purpose of the testator, and not to the adventitious circumstances connected with the administration of the estate which are not mentioned in the will as affecting the testamentary intent; otherwise, through their measurable control of such circumstances, power would rest with executors or trustees to determine when, if ever, the passing of an estate by will should be subject to the payment of a tax imposed by act of Congress. That the legatee was not given control over the income in advance of the actual payment thereof to him did not render the bequest contingent nor prevent it from vesting in enjoyment within the lines of restriction imposed by the testator. The effect of restrictions of that character would be upon the value of the interest which the legatee secured, and concerning that there is no controversy here.

When was the tax imposed? Section 30 of the original act of 1898, as amended by the act of 1901, provided: "That the tax or duty aforesaid shall be *due and payable in one year after the death of the testator and shall be* a lien and charge upon the property of every person who may die as aforesaid for twenty years or until the same shall, within that period, be fully paid," etc. The words italicized were interpolated by the amendatory act; otherwise the clause is as it stood originally in the act of 1898. Upon this the trust company contends that as the testator died December 11, 1901, the tax did not become due until December 11, 1902, and therefore was destroyed by the repealing act of 1902, because it had not been "imposed" within the meaning of the saving clause of that act. Two grounds are urged in support of this contention: First, that the tax cannot be said to have been imposed before it became due and payable; and, second, that the effect of the amendment of 1901 was to postpone the commencement of the lien period for one year from the testator's death, and the tax cannot be said to be imposed before the lien attaches.

The language of section 29 of the act of 1898 is that the persons having the legacies or distributive shares in charge "shall be, and hereby are, made subject to a duty or tax," etc. And we think that when there came into existence the conditions upon which the statute operated the tax was at once imposed, and the estate of the decedent became subject to a lien therefor. Then is when the right to the tax accrued or came into existence, though the tax may not have been at once demandable as due. The act of 1898 specified no time when the tax became due and payable, and the amendment of 1901 that it should become due and payable in one year after the death of the testator was designed to secure uniformity in administration and to give those subject to the tax a reasonable time to adjust the affairs in their charge and make provision for payment. The imposition of a tax and its

maturity are distinct and separate things, and are commonly recognized to be so in schemes of taxation. To impose a tax means to levy it, and we all know that it is not the general custom to make a tax due and enforceable the very day it is imposed or levied. The levy of taxes by state boards and those of governmental subdivisions of the state are generally long in advance of the day they become due, when, if not paid, proceedings for enforcement may be begun. A specific instance in national taxation may be found in the amended act of June 30, 1864, c. 173, § 119, 13 Stat. 283, amended by Act March 2, 1867, c. 169, § 13, 14 Stat. 480, which provided that the income taxes should be levied on the 1st day of March and be due and payable on or before the 30th day of April. When a legacy vests in possession or enjoyment the statute then imposes the tax at the rate therein prescribed. *Savings Bank v. United States*, 19 Wall. 227, 22 L. Ed. 80, was an action of debt by the government to recover of the bank internal revenue taxes upon undistributed earnings. It was contended by the bank that the action would not lie because the officers of the government had not previously made an assessment, but it was held that no other assessment than that made by the statute was necessary. It is also said in the case before us that the provision for a lien means that the 20-year period begins one year from the testator's death, and the tax cannot be said to have been imposed in advance of the lien. But the conclusion does not follow. A lien may be created to commence from either the imposition or levy of a tax or from its due day as in the judgment of the legislative body may seem advisable. Nor do we think the lien did not begin until a year from the testator's death. The reasonable construction of the act of 1898 before it was amended is that if the estate vested in possession or enjoyment at the death of the testator the lien immediately attached. If the amendment of 1901, that the tax should be due and payable one year after the testator's death, had been inserted after the clause relating to the lien instead of before it, it could hardly be said that a change in the time of the commencement of the lien was intended; and we do not think a different construction results merely because the amendment was inserted before instead of after the lien provision. The lien of a tax may as naturally precede its final due day as the act of imposing or levying the tax itself, and it is quite doubtful that Congress intended there should be a year after the vesting of a legacy or a distributive share of an estate in possession or enjoyment, and therefore, certainly, the subject of a tax, during which no lien or charge existed protecting the government against the distribution of the estate and the consumption or dissipation of that upon which it was intended the lien should rest. At any rate, all who are familiar with systems of taxation know that the initial day of the lien period and the final due day of the tax, after which proceedings to compel payment may be begun, are not inseparable. The provision of the amendatory act that the tax should be due and payable in a year after the testator's death did not mean the tax could not be paid any time within the year, but, on the contrary, that the period granted the executor or trustee for repose or preparation terminated with the year, and thereafter the government might avail itself of any appropriate remedy for enforcing payment. We recog-

nize that grave doubts surround the true construction of these statutes, and also that other courts have reached a different result, and we fully appreciate the desirability of uniformity of decision among the circuits, yet in the absence of a controlling decision by the Supreme Court, our jurisdiction being invoked, we have felt constrained to express our opinion, after according, as we have, to the views of the courts which differ with us, the persuasive force they are justly entitled to. That the right construction is not clear is emphasized by the fact that the Supreme Court has three times affirmed judgments in cases like this by an equal division of the justices who participated. We think that the conclusions reached by the several Circuit Courts and Circuit Courts of Appeals in cases which will presently be reviewed is due in large measure to a misapprehension of what was decided by the Supreme Court in *Clapp v. Mason*, 94 U. S. 589, 24 L. Ed. 212, and *Mason v. Sargent*, 104 U. S. 689, 26 L. Ed. 894.

In *Clapp v. Mason*, 94 U. S. 589, 24 L. Ed. 212, a testator devised real property to his wife for her life or during occupancy, and thereafter to Mason and Parker. The tax on legacies and successions imposed by the act of 1864 was repealed in 1870, with a saving clause as to taxes the right to which had "accrued." The widow's estate terminated by her death after the repealing act took effect. The Supreme Court held that under the act of 1864 a succession should not be deemed taxable until such time as the successor was entitled to its possession, and consequently no tax upon the devise to Mason and Parker had "accrued" when the act was repealed. It is true that in reaching this conclusion references were made to the express provision of the act of 1864 that the tax should be paid when the successor became entitled to possession and to those of the act of 1866 that the lien on the successor's interest came into being when the tax became due, and that the assessment was to be made within 30 days from the time the party became entitled to possession; but these and various other references to specific provisions of the acts were merely employed as aids to the discovery of the legislative intent, which was found to be that the right to the tax did not accrue until the estate vested in possession. Both vested estates and those in expectancy were within the act of 1864, and it could not certainly be known who would be liable for the tax, upon what value it should be paid, nor at what rate, until the arrival of the time of enjoyment. Therefore it was then the tax accrued. But there is no such question here. The act of June 27, 1902, which was a legislative affirmance of the true construction of the act of 1898, expressly provided that the tax was imposed only on vested interests when vested in possession or enjoyment. It was then the right to the tax arose under the act of 1898.

Mason v. Sargent, 104 U. S. 689, 26 L. Ed. 894, involved a tax imposed in respect of another bequest in the will referred to in *Clapp v. Mason*. Personal property was bequeathed to trustees in trust for the testator's widow during her life, and on her death to his children. As already observed, the statute imposing the tax was repealed before the widow died, with a saving clause as to taxes the right to which had accrued. The court again held the true construction of the statute there involved to be that the interest of the legatees in remainder was

not subject to the tax until the right arose to reduce it to possession, and that in the case under consideration there was no such right while the widow lived. We do not think it can fairly be said to have been held in either of these cases that the tax was not imposed before the estate vested in possession because or by reason of the fact that the due day of the tax was fixed at that time. The provision fixing the time when the tax should be paid and various other provisions of the statute, of different degrees of significance, were referred to by the court as indicating in their entirety the intent of Congress to be that there was no tax, no right to a tax, until the legatee had the beneficial possession or enjoyment of his legacy. This is far from holding that the mere fixing of the time when the tax should be paid fixed the time when the tax was imposed.

Tilghman v. Eidman (C. C.) 131 Fed. 651, involved the act of 1898 and those following. It was held by the Circuit Court for the Southern District of New York upon the authority of *Mason v. Sargent*, but without discussion, that, as no tax was due and payable and no lien for any tax rested upon the property of the deceased when the repealing act of 1902 took effect, no tax had been imposed within the meaning of the saving clause of the latter act. This case was affirmed by the Court of Appeals of the Second Circuit (*Eidman v. Tilghman*, 69 C. C. A. 139, 136 Fed. 141), and by the Supreme Court without opinion, the justices being equally divided (203 U. S. 580, 27 Sup. Ct. 779, 51 L. Ed. 326). The Court of Appeals rested its conclusions in part upon *Clapp v. Mason* and *Mason v. Sargent*.

In *Vanderbilt v. Eidman*, 196 U. S. 480, 25 Sup. Ct. 331, 49 L. Ed. 563, the income of a residuary estate was to be paid to a son of the testator while he was between 21 and 30 years of age. He was then to receive one-half of the principal, and the income on the balance until he was 35, and then the balance was to be given into his possession. The tax was duly paid upon the right to the beneficial enjoyment of the income as provided by the act of 1898, and the controversy arose over the subsequent exaction by the government of a tax on his right to succeed to the whole residue if he lived to the ages of 30 and 35 years respectively. The court held that the deferred rights were not vested in possession or enjoyment and were therefore not the subject of a tax. The case is only pertinent here in respect of the general acquiescence in the liability to the tax of the bequest of the income to trustees in trust for the son. To that extent it bears on the first question discussed—whether the bequest of the income to Charles A. Madill for life was vested in enjoyment. To the same effect are *Herold v. Shanley*, 76 C. C. A. 478, 146 Fed. 20; *Shanley v. Herold*, 141 Fed. 423. The question again arose in *Philadelphia Trust etc., Co. v. McCoach*, 135 Fed. 866. The Circuit Court for the Eastern District of Pennsylvania held that it would follow without discussion the ruling of the Court of Appeals of the Second Circuit in *Eidman v. Tilghman*. The Court of Appeals of the Third Circuit affirmed the judgment, also without discussion (73 C. C. A. 610, 142 Fed. 120), saying the Circuit Court was right in following the other case because of considerations of comity and uniformity

of decision. It was also affirmed by a divided Supreme Court. 205 U. S. 539, 27 Sup. Ct. 793, 51 L. Ed. 821. In *McCoach v. Bamberger* (C. C. A.) 161 Fed. 90, the Court of Appeals of the Third Circuit adhered to the position it had previously taken. The question also came before the Court of Appeals of the First Circuit in *Gill v. Austin*, 84 C. C. A. 677, 157 Fed. 234. The court followed the decision of the Court of Appeals of the Second Circuit in *Eidman v. Tilghman*, and did not itself express an opinion on the question.

United States v. Marion Trust Co., 74 C. C. A. 439, 143 Fed. 301, was decided by the Court of Appeals of the Seventh Circuit. There the owner from whom the succession was derived died September 10, 1900, nearly two years before the act of 1898 was repealed, but because of a dispute between certain persons who claimed to be heirs and the pendency of certain unsettled claims the estate was not distributed until after the repeal took effect. It was held that the tax prescribed by the act of 1898, being an ad valorem tax, could be imposed only by assessment, that an assessment was prerequisite to the existence of the tax, and that no assessment could take place until the estate was ready to pass without diminution so the amount of the tax could be determined. The conclusion was that no tax had been imposed upon the distributive share under consideration when the repealing act took effect. This case was also affirmed by a division of the Supreme Court. 205 U. S. 539, 27 Sup. Ct. 794, 51 L. Ed. 1191. So far as the case holds that the tax is not imposed until the estate vests in possession or enjoyment, we are in entire accord with it, but we think there are serious objections to the position that such circumstances as those mentioned arising during the course of administration postpone the vesting in enjoyment contemplated by the statute. The express provision in the amendatory act of 1901 that the tax "shall be due and payable in one year after the death of the testator" would in itself indicate a contrary intent, at least as respects estates passing by will, and we do not doubt the principle of the provision would also apply to those passing from intestates. Nor do we think there is anything in the statute indicating that an assessment or any other affirmative act by the collector is a necessary prerequisite to the imposition of the tax and the creation of the lien upon the estate of the decedent. When the successor is entitled to the beneficial enjoyment of the estate, though he has it not in possession, the law at once imposes the tax. The ascertainment of the precise amount in dollars and cents is a detail of administration which makes certain the charge previously fixed by law upon the estate.

The judgment of the Circuit Court is reversed, and the cause is remanded with direction to overrule the demurrer of the trust company to the answer of the collector, and for further proceedings consistent with this opinion.

DR. MILES MEDICAL CO. v. JOHN D. PARK & SONS CO.†

(Circuit Court of Appeals, Sixth Circuit. September 10, 1908.)

No. 1,797.

1. MONOPOLIES (§ 17*)—CONTRACTS IN RESTRAINT OF TRADE—SALE OF PROPRIETARY MEDICINE.

A system of contracts between the manufacturer of a proprietary medicine made in accordance with a secret formula but unpatented and all dealers authorized by it to handle such medicine, whether regarded as contracts of sale or agency, by which jobbers are prohibited from selling to any except retailers licensed by such manufacturer, and retailers are prohibited from selling to any save those licensed to buy or to persons buying for consumption only, and neither jobber nor retailer is permitted to sell except at prices imposed by the manufacturer, the purpose and effect being to maintain prices by preventing competition in price between either jobbers or retailers, where it affects interstate sales is illegal both at common law and under the federal anti-trust act of July 2, 1890, c. 647, 26 Stat. 209 (U. S. Comp. St. 1901, p. 3200), as in restraint of trade.

[Ed. Note.—For other cases, see Monopolies, Cent. Dig. § 13; Dec. Dig. § 17.*]

2. SALES (§ 7*)—CONTRACTS—CONSTRUCTION—SALE OR BAILMENT.

Contracts between the manufacturer of a proprietary medicine and jobbers dealing in the same which purport to be consignment contracts and to make the jobbers agents for the manufacturer and provide that title to the goods shall remain in the manufacturer until they are sold by the jobber to purchasers whom it has licensed to buy the same and at prices fixed by it, but which obligate the jobbers to pay a fixed price for the medicine without the right to return it and under which the title is retained even after the price has been paid or "advanced," are mere subterfuges to disguise purchasers in the mask of agency and to evade the law which would make open contracts of sale with the same restrictions upon resale illegal as in restraint of trade, and are in fact contracts of sale and not of agency.

[Ed. Note.—For other cases, see Sales, Cent. Dig. §§ 16, 17; Dec. Dig. § 7.*]

Appeal from the Circuit Court of the United States for the Eastern District of Kentucky.

This is a bill by manufacturers of proprietary medicines who put them upon the market under a system of contracts intended to maintain the prices fixed by them. There are two forms of these contracts, one with wholesalers and another with retailers. Like contracts, it is claimed, have been made and signed by nearly all jobbers and retailers in the United States who deal in such goods. These contracts are set out at the close of the opinion.

The defendant company refuses to enter into any such agreement, and, according to the averment of the bill, illegally induces persons who have to violate their contracts by selling to him though unauthorized to buy and at prices below those which such persons are required to exact. It is also averred that for the purpose of protecting the seller from the consequences of a breach of contract the defendant company defaces the carton inclosing the medicine and destroys the evidence thereon or thereto attached by which, through a serial number, complainant might trace the seller who breached the contract. In addition, it is charged that defendant sells to retailers who carry on a "cut rate" business, who in turn retail to consumers at rates less than those at which complainant requires all retailers to exact from persons buying for use. The bill in all its important averments as to the manner in which complainant carries on its business and the advantages of such method and the evils of the "cut rate" business in such goods, as well as its averments as

*For other cases see same topic & § NUMBER in Dec. & Am. Digs. 1907 to date, & Rep'r Indexes

†Writ of error granted by Supreme Court.

to the knowledge of the system possessed by the defendant, are substantially identical with the averments of the bill under consideration by this court in *Jno. D. Park & Sons Co. v. Hartman*, 153 Fed. 24, 82 C. C. A. 158, 12 L. R. A. (N. S.) 1135. In the Hartman system of contracts, the contract between Hartman and the jobber was confessedly one of sale; under the Dr. Miles system, it is claimed, it is one of consignment or agency and not sale. With this distinction, if it exist, the opinion in the Hartman Case may be referred to for a more detailed statement of the evils of the competitive or "cut rate" system and the advantages of the one price or noncompetitive plan which the complainant seeks to bring about by the system of contracts here involved.

The acts and conduct against which complainant seeks relief are identically the conduct complained of in the Hartman Case, and the opinion in that case may be referred to for a more detailed statement of the case here made for relief. A demurrer to the bill was sustained upon the authority of the opinion of this court in the Hartman Case.

Frank F. Reed (Edward S. Rogers and Frederick W. Hinkle, on the brief), for appellant.

William J. Shroder, for appellee.

Before LURTON, SEVERENS, and RICHARDS, Circuit Judges.

LURTON, Circuit Judge (after stating the facts as above). We see no substantial difference between the systems of contracts under which the Dr. Miles Medical Company is now conducting its business and that under which Dr. Hartman carried on his business as a manufacturer of Peruna, considered by this court at length in the case of *Jno. D. Park & Sons v. Hartman*, 153 Fed. 24, 82 C. C. A. 158, 12 L. R. A. (N. S.) 1135. That case is pending, undecided, in the Supreme Court. The complainant's very learned counsel was the counsel for Hartman in that case, and both systems of contracts are most probably the fruit of his acknowledged skill in respect to this class of business arrangements. No difference whatever is suggested between the system of contracts considered in that case and those here presented, except, it is claimed, that the agreement with jobbers and wholesale dealers here involved is one of bailment or agency and not one of sale as in the Hartman Case. If this were admitted, it does not, in our judgment, operate to legalize the "system" of which that agreement is but one part. The effect of that contract with jobbers, whether it be regarded as one of sale or of agency, is to restrain jobbers from selling to any save retailers licensed by complainant, and to restrain retailers from selling for resale to any save those licensed to buy or to persons who buy for consumption only, and to none, by either jobber or retailer, except at a price imposed by the manufacturer. The confessed object of this plan or system is to obtain a price to the jobber and to the retailer unaffected by any competition between them. The scheme is one to enhance or maintain prices by eliminating all possibility of competing rates between either jobbers or retailers, and is quite as effectual in its results as if the contract with the jobber was plainly one of sale.

But we are not disposed to concede that the contracts with jobbers are contracts of bailment. There are too many features which seem inconsistent with a mere agency or commission agreement. All the responsibility of an owner seems cast upon the so-called "consignee." He is not given the right to return goods unsold; that can be done only upon the cancellation of the contract and demand for return. The

retention of title for the security of the price would after all make the contract one of conditional sale, and the jobber would still be the general owner and responsible as such. Curiously enough, the actual payment of the price at which the consignment is billed is not to affect the title; it is still, under the contract, to remain with the so-called "consignor." Yet the heavy inducement of 5 per cent. upon a very close class of goods is held out to induce a payment in advance of sales. It is difficult to believe, whatever the technical relation of the parties under such an agreement, and whatever the belief each may have had as to his relation to the other, that such jobbers were not in fact and law the general owners of goods so "consigned," and engaged in selling for themselves and not as the mere agents, *del credere* or otherwise, of the complainant. The scheme seems to be an effort to disguise the wholesale dealers in the mask of agency upon the theory that in that character one link in the system for the suppression of the "cut rate" business might be regarded as valid. Hardly any two contracts raising the question of sale or agency are so near alike as to make an opinion construing one an authority in another. It matters little what the parties call such agreements. Whether the result is a sale or an agency must depend upon the meaning and intent of the instrument as a whole. Looking at this agreement thus, we think the jobber must be regarded as the general owner and engaged in selling for himself and not as a mere agent of another. True, he must sell, if this system of doing business is valid and enforceable, as he obligates himself to do, but nevertheless he is selling for himself and upon his own account and risk. *Coweta Fertilizer Co. v. Brown* (decided at this term, and cases therein cited) 163 Fed. 162; *Ex parte White*, L. R. 1870, 6 Ch. App. Cases; *Mack v. Drummond Tobacco Co.*, 48 Neb. 397, 67 N. W. 174, 58 Am. St. Rep. 691; *Peoria Co. v. Lyons*, 153 Ill. 427, 38 N. E. 661; *Arbuckle v. Kirkpatrick*, 98 Tenn. 221, 39 S. W. 3, 36 L. R. A. 285, 60 Am. St. Rep. 854.

This case must, after all, turn upon whether there is such identity of character between the statutory monopoly of articles made under a valid patent or copyright and articles made according to some private formula as to exempt them from the principles which apply to contracts which tend to create a monopoly or restrain trade when the subject is an article not made under a patent or copyright or secret formula. A distinction exists between the extent of the protection granted by the patent and copyright statutes, and the copyright statute has been held "not to create the right to impose, by notice, a limitation at which a book shall be sold at retail by future purchasers, with whom there is no privity of contract." *Bobbs Merrill Co. v. Straus* (decided by the Supreme Court, June 1, 1908) 210 U. S. 339, 28 Sup. Ct. 722, 52 L. Ed. 1086. This distinction has been drawn since the decision of the cases we refer to, and since the decision of the *Hartman Case* above referred to. There are decisions by most respectable courts which hold that articles, such as proprietary medicines, are outside of all rules and statutes which forbid contracts in restraint of trade, because they are made under a secret formula. Some, if not most, of these decisions have been made in cases in which the *Dr. Miles Medical Company* has been a party. They are cited and commented

upon by this court in the case of *Jno. D. Park & Sons v. Hartman*, 153 Fed. 24, 34, 82 C. C. A. 158, 12 L. R. A. (N. S.) 1135. They go upon the conceded fact that a trade secret or medical formula is a monopoly until discovered by fair means, and will be protected against abuse by one who learns it under a contract limiting its use or in the confidence of an employment. They do not observe any distinction between the necessary monopoly of the secret itself and the unnecessary monopoly of the articles made according to the secret process and offered for sale and resale to the consuming public. Neither do those decisions recognize any distinction between the statutory monopoly accorded to articles protected by a patent or copyright and those made under such private formulas. The argument in support of this result is epitomized in all the cases referred to, but may be seen in full in the opinion of Colt, C. J., in the case styled "*Dr. Miles Medical Co. v. Jaynes Drug Co.*" (C. C.) 149 Fed. 838. The same argument was presented by the counsel now representing the *Dr. Miles Medical Company* in the case decided by this court of *Jno. D. Park & Sons Co. v. Hartman*, 153 Fed. 24, 82 C. C. A. 158, 12 L. R. A. (N. S.) 1135, and again presented with elaboration in the present case. In the case referred to, we reached with unanimity the conclusion that no legal, economic, or moral reason existed for regarding contracts in respect to the vast and ever-increasing commerce in proprietary medicines as either outside of the mischief intended to be remedied by the federal statute against monopolies or the rules of the common law, or within the statutory protection afforded by the patent and copyright statutes. Any other conclusion would be to sanction a monopoly in that class of goods vastly more far-reaching than the monopoly extended upon high grounds of public policy to the inventor. The statutory monopoly has a limitation of a few years. To obtain it the inventor must put on record his invention. At the end of the term the public will be free to employ the discovery without the burden theretofore imposed as a compensation to the inventor. Not so with the monopoly asked for by those who control the enormous proprietary trade of this country. Their monopoly will go on forever, and, if there be merit in their formula, they may not only preserve it through all time, but continue to restrain prices and prevent competition in the sale of the product. It is said that the proprietor of such a secret remedy need never communicate his formula. Concede this. To say that he need never compound his medicine, and that, if he does, he need not sell it unless he chooses, is undoubtedly true. But as much may be said about any article which the producer may choose to make or not to make, sell or not sell, as he wills. So much pertains inherently to the natural freedom of man in respect to his own actions. But if he elects to make and sell a product according to his formula, a public interest is affected if he be permitted to restrain freedom of trade in the article when it has once passed under the dominion of a buyer. A free right of alienation is an incident to the general right of property in articles which pass from hand to hand in the commerce of the world. *Coke on Littleton*, § 360. The mere fact that one article or class of articles is made under an unknown and private formula and another class is not an undeniable fact which may serve for some purposes to differentiate them. But

that single fact does not afford an economic reason, and still less a legal reason, for saying that it operates to exempt such articles from rules against unlawful restraints of trade.

We need not repeat the argument by which we reached the conclusion that the system of contracts which Hartman sought to enforce through the injunctive power of a court of equity was obnoxious not only to the statute of Congress against restraints and monopolies in respect of interstate trade but inimical also to the reasonable restraints which at common law may be imposed as ancillary to a principal contract. All that we said in respect to the Hartman system is applicable here. The case falls directly within the reasoning and decision of that case in respect to every aspect of the question, and the decree sustaining the demurrer interposed by the appellees must be affirmed.

"Consignment Contract. Wholesale. The Dr. Miles Medical Company.

"This agreement made by and between the Dr. Miles Medical Company, a corporation, of Elkhart, Indiana, hereinafter referred to as the proprietor and _____ hereinafter referred to as the consignee, witnesseth:

"That the said proprietor hereby appoints said consignee one of its wholesale distributing agents, and agrees to consign to such consignee for sale for the account of said proprietor such goods of its manufacture as the proprietor may deem necessary, the title thereto and property therein to be and remain in the proprietor absolutely until sold under and in accordance with the provisions hereof, and all unsold goods to be immediately returned to said proprietor on demand and the cancellation of this agreement. Said goods to be invoiced to consignee at the following prices:

"Medicines, of which the retail price is \$1.00; \$8.00 per dozen.

"Medicines (if any) of which the retail price is 50 cents; \$4.00 per dozen.

"Medicines, of which the retail price is 25 cents; \$2.00 per dozen.

"Freight on all orders, the invoice price of which amounts to \$100.00 or more, to be prepaid by the proprietor; otherwise, freight to be paid by consignee.

"Said consignee agrees to confine the sale of all goods and products of the said proprietor strictly to and to sell only to the designated retail agents of said proprietor as specified in lists of such retail agents furnished by said proprietor and alterable at the will of said proprietor, and to faithfully and promptly account and pay to the proprietor the proceeds of all sales, after deducting as full compensation for all services, charges and disbursements a commission of ten per cent of the invoice value, and a further commission of five per cent on the net amount of each consignment, after deducting the said ten per cent commission, on all advances on account remitted within ten days from date of any consignment, it being agreed between the parties hereto that such advances shall in no manner affect the title to such goods, which title shall remain in the proprietor as if no such advances had been made; provided that such advances shall be repaid to said consignee should the said proprietor terminate this agreement and the return of any unsold goods on which advances have been made. Said consignee guarantees the payment for all goods sold under this agreement and agrees to render a full account and remit the net proceeds on the first day of each month of and for the sales of the month preceding. Failure to make such accounting and remittance within ten days from the first of each month shall render the whole account payable and subject to draft, but the proceeds of such draft shall not affect the title of any unsold goods which shall remain in the proprietor until actually sold, as herein provided.

"It is further agreed that the consignee shall furnish the proprietor from time to time upon demand full statements of the stock of goods of the proprietor on hand on any date specified and that a failure to furnish such statements within ten days from date of such demand shall be a sufficient cause for the cancellation of this agreement, and a demand for the return of the consigned goods.

"It is further agreed that the proprietor will cause each retail package of its goods to be identified by a number and said consignee hereby agrees to furnish the said proprietor full reports upon proper cards or blanks furnished by said proprietor of the disposition of each dozen or fraction of such goods by means of the identifying numbers, specifying the names and addresses of the retail agents to whom such goods have been delivered and the dates of such delivery, and to send such reports to said proprietor at least semi-monthly, and at any other time on the request of said proprietor.

"It is understood and agreed between the parties hereto that the commissions herein specified shall not be considered as earned by said consignee upon any goods of said proprietor which shall have been delivered to dealers not authorized agents of said proprietor, as per list of such agents, or upon any goods whose disposition by said consignee shall not have been properly reported as herein provided, or sold at prices less than the prices authorized, and that said consignee shall not credit any such commissions when making remittances on consignment account provided notice has been given by said proprietor that such commissions are unearned; and that if such unearned commissions have been deducted by said consignee in making advance payments or monthly remittances on account they shall be charged back to said consignee and credited and paid to said proprietor. It is understood that violation or non-observance of any provision hereof by the consignee shall make this agreement terminable and all unsold goods returnable at the option of the proprietor.

"It is agreed that the goods of said proprietor shall be sold by said consignee only to the said retail or wholesale agents of said proprietor, as per list furnished, at not less than the following prices, to-wit:

"Medicines, of which the retail price is \$1.00; \$8.00 per dozen.

"Medicines (if any), of which the retail price is 50 cents; \$4.00 per dozen.

"Medicines, of which the retail price is 25 cents; \$2.00 per dozen.

"Provided, that said consignee may allow a cash discount not exceeding one per cent, if paid within ten days from date of invoice, and that when sales at one time and at one invoice, amount to \$15.00 or more, the said consignee may allow three per cent trade discount, and if said purchase amounts to \$50.00 or more, five per cent trade discount, all without cost to the proprietor, and if such \$50.00 quantity shall be shipped direct to the retail purchaser from the laboratory of the said proprietor, on the order from the said wholesale distributing agent, freight will be prepaid by the proprietor, but not otherwise.

"This contract will take effect when the original, duly signed by the consignee, has been received and accepted by the Dr. Miles Medical Company, at Elkhart, Indiana.

"Done under our hands _____ A. D., 1907.

(Fill in date on above line.)

"The Dr. Miles Medical Company.

"_____

"Wholesale dealer. Sign your name on above line. Original return in enclosed envelope."

"Retail Agency Contract.

"The Dr. Miles Medical Company.

"This agreement between the Dr. Miles Medical Company of Elkhart, Indiana, and _____ of _____, Retailers named on above line, _____ Town, _____ State, hereinafter referred to as the retail agent, witnesseth:

"Appointed Agent.

"The said Dr. Miles Medical Company hereby appoints said retail dealer as one of the retail distributing agents of its proprietary medicines and agrees that said retail agent may purchase the proprietary medicines manufactured by said Dr. Miles Medical Company (each retail package of which the said company will cause to be identified by a number) at the following prices, to-wit:

"Wholesale Prices.

- "Medicines, of which the retail price is \$1.00; \$8.00 per dozen.
- "Medicines, of which the retail price is 50 cents; \$4.00 per dozen.
- "Medicines, of which the retail price is 25 cents; \$2.00 per dozen.

"Quantity Discounts.

"Provided that when purchasers at one time and on one invoice amount to \$15.00 (or more), wholesale distributing agents are authorized to allow three per cent trade discount; if such purchase amounts to \$50.00 (or more) five per cent trade discount will be allowed, and if such \$50.00 quantity be shipped direct to the purchaser from the laboratory of said Dr. Miles Medical Company for the account at such wholesale agent, freight will be prepaid, but not otherwise.

"Full Price.

"In consideration whereof said retail agent agrees in no case to sell or furnish the said proprietary medicines to any person, firm or corporation whatsoever, at less than the full retail price as printed on the packages, without reduction for quantity; and said retail agent further agrees not to sell the said proprietary medicines at any price to wholesale or retail dealers not accredited agents of the Dr. Miles Medical Company.

"Violation.

"It is further agreed between the parties hereto that the giving of any article of value, or the making of any concession by means of trading stamps, cash register coupons, or otherwise, for the purpose of reducing the price above agreed upon shall be considered a violation of this agreement, and further it is agreed between the parties hereto that the Dr. Miles Medical Company will sustain damage in the sum of twenty-five dollars (\$25.00) for each violation of any provision of this agreement, it being otherwise impossible to fix the measure of damage.

"This contract will take effect when a duplicate thereof, duly signed by the retail agent, has been received and approved by the Dr. Miles Medical Company, at its office at Elkhart, Indiana.

"Done under our hands _____, A. D., 1907.
(Fill in date on above line.)

"The Dr. Miles Medical Company.

"_____

"Retail dealer, sign your name on above line in ink.

"To retail dealer:

"Paste printed label, giving name and address, that your name may be correctly listed.

"Duplicate. Keep for reference."

GUARANTEE GOLD BOND LOAN & SAVINGS CO. v. EDWARDS et al.

(Circuit Court of Appeals, Eighth Circuit. October 28, 1908.)

No. 2,760.

1. EQUITY (§ 409*)—PRACTICE—MASTER'S CERTIFICATE OR OTHER PROOF OF ENTIRE EVIDENCE REQUISITE TO ASSAIL HIS FINDING OF FACT.

The master's finding of facts upon evidence taken before him cannot be impeached, in the absence from the record of his certificate or other competent proof, either that the evidence presented is the entire evidence that was before him, or that it was all the evidence which was before him relative to the specific finding or findings challenged.

[Ed. Note.—For other cases, see Equity, Dec. Dig. § 409.*]

*For other cases see same topic & § NUMBER in Dec. & Am. Digs. 1907 to date, & Rep'r Indexes

2. EQUITY (§ 409*)—ORDER TO REPORT EVIDENCE AND REPORT THEREOF COMPETENT PROOF.

An order of the court that the master should take and report the evidence, his report of it, and the legal presumption of his faithful discharge of official duty constitute competent proof that he has returned all the evidence before him, in the absence of evidence to the contrary.

[Ed. Note.—For other cases, see Equity, Cent. Dig. §§ 920, 923; Dec. Dig. § 409.*]

3. EQUITY (§ 403*)—CONSENT TO REFERENCE TO MASTER NOT INFERRED FROM ABSENCE OF OBJECTION TO GENERAL ORDER.

The consent of parties to a suit in equity to a reference to a master to find the facts, which will render his finding upon conflicting evidence unassailable under the rule in *Kimberly v. Arms*, 129 U. S. 512, 9 Sup. Ct. 355, 32 L. Ed. 764, may not be inferred from the mere failure to object to a general order of reference made before the suit was commenced.

[Ed. Note.—For other cases, see Equity, Cent. Dig. § 879; Dec. Dig. § 403.*]

4. APPEAL AND ERROR (§ 931*)—MASTER'S FINDINGS PRESUMPTION OF CORRECTNESS.

The legal presumption is that the findings of the master upon conflicting evidence are correct, and they will not be set aside unless it appears with reasonable clearness that he has fallen into a mistake of fact or committed an error of law.

[Ed. Note.—For other cases, see Appeal and Error, Cent. Dig. § 3762; Dec. Dig. § 931.*]

5. MORTGAGES (§ 38*)—DEED INTENDED AS MORTGAGE—SUFFICIENCY OF EVIDENCE.

The legal presumption is that a deed expresses the intention of the parties, and the evidence must be clear and convincing to sustain a decree that it was intended as a mortgage.

The evidence in this case considered, and held to be of this character.

[Ed. Note.—For other cases, see Mortgages, Cent. Dig. § 109; Dec. Dig. § 38.*]

(Syllabus by the Court.)

Appeal from the United States Court of Appeals in the Indian Territory.

For opinion below, see 104 S. W. 624.

Edgar A. De Meules (C. L. Thomas, on the brief), for appellant.
A. E. Patterson and J. H. Lilley, for appellees.

Before SANBORN and HOOK, Circuit Judges, and AMIDON, District Judge.

SANBORN, Circuit Judge. This is a suit in equity brought by Rachel A. Edwards, an unsophisticated Indian woman, and her husband, Silas Edwards, to obtain a decree that a warranty deed which recited a consideration of \$2,450, which conveyed a tract of land worth about \$2,000, and which they made on September 7, 1905, to the Guarantee Gold Bond Loan & Savings Company, was in fact a mortgage for \$300. The gravamen of the bill was that the savings company obtained this deed for \$300 by the fraudulent representation that it was a mortgage for that amount, and that the grantor signed and delivered it in the belief that it was an instrument of that character. The savings company denied the charge, and the defendant Swanson inter-

*For other cases see same topic & § NUMBER in Dec. & Am. Digs. 1907 to date, & Rep'r Indexes

vened and claimed the land on the ground that he had purchased it of the complainants subsequent to their deed to the savings company. The suit was referred to a master in chancery "to take evidence and report with conclusions of law and fact" under a general order made by the court before this suit was commenced to the effect that all equity cases should be so referred. The master reported that certain witnesses, whom he mentioned, were sworn and examined, that their testimony was reduced to writing "and is attached hereto and made a part of this report," that no fraud was practiced on the complainant, that the deed was valid, that its consideration was \$600, that Swanson had no equitable interest in the land, and he recommended that the bill should be dismissed. The chancellor sustained exceptions to the report, and rendered a decree that the deed was intended as and was a mortgage for \$300 and interest at 8 per cent. per annum, and that upon a payment of that amount the complainants should recover their land. An appeal was taken from that decree, it was affirmed by the United States Court of Appeals of the Indian Territory, and the savings company has appealed to this court from the judgment of affirmation.

The first specification of error is that the courts below erred in considering the evidence returned by the master, and in reversing his findings of fact founded thereon, because he made no certificate that he had returned all the evidence taken before him. They invoke the decision of the Supreme Court in *Sheffield & Birmingham Coal, Iron & Ry. Co. v. Gordon*, 151 U. S. 285, 293, 14 Sup. Ct. 343, 38 L. Ed. 164, wherein the order of reference did not require the master to send up the testimony, he did not purport to do so in his report, and, while some depositions taken before him were found in the record, there was nothing to indicate that these were all the testimony which he considered. In the case at bar the order required the master to report the testimony. He reported that certain witnesses testified before him, that their testimony was reduced to writing, and was attached to and made a part of his report. It was the duty of the master to report all the evidence. The legal presumption, in the absence of countervailing proof, is that he discharged his duty. He returned evidence which he reported was taken before him, and the presumption must be that he returned all the evidence presented to him. The true rule upon this subject is that a master's finding of facts upon evidence taken by him cannot be impeached in the absence from the record of his certificate, or other competent proof, either that the evidence presented is the entire evidence taken by him, or that it contains all the evidence which was before him relative to the specific finding or findings challenged. *Wheeler v. Abilene Nat. Bk. Bldg. Co.* (C. C. A.) 159 Fed. 391, 392; *Sheffield, etc., R. Co. v. Gordon*, 151 U. S. 285, 293, 14 Sup. Ct. 343, 38 L. Ed. 164; *Greene v. Bishop*, 1 Cliff. 186, Fed. Cas. No. 5,763; *Donnell v. Columbia Ins. Co.*, Fed. Cas. No. 3,987; *McCourt v. Singers-Bigger*, 145 Fed. 103, 112, 76 C. C. A. 73, 82; *Scotten v. Sutter*, 37 Mich. 526; *Nay v. Byers*, 13 Ind. 412; *Fellenzer v. Van Valzah*, 95 Ind. 128. But the order of a court to a master to report the evidence, his report of it, and the legal presumption of his faithful discharge of his official duty constitute competent proof, in the absence of countervail-

ing evidence, that he has reported all the evidence that was taken before him. The result is that the courts below committed no error in examining the testimony reported by the master to determine whether or not his findings of fact were sustained thereby.

The next contention is that since the case was referred to the master by consent, and since his finding that the deed was not procured fraudulently and was not intended as a mortgage was founded upon conflicting evidence, it was unassailable, and the courts below erred in reversing it under the decisions in *Kimberly v. Arms*, 129 U. S. 512, 516, 524, 9 Sup. Ct. 355, 32 L. Ed. 764, and *Davis v. Schwartz*, 155 U. S. 631, 633, 637, 15 Sup. Ct. 237, 39 L. Ed. 289. But in those and similar cases where the rule here invoked prevailed the parties consented to the references to the masters, while in this case the reference was made by a general order before the suit was commenced without the knowledge or consent of any one connected with it. The fact that the parties to this suit proceeded with the prosecution of it under this general order without objection was not a request for or a consent to the order; it was nothing but a compliance with it, and the case does not fall under the rule applicable to cases of consent.

Counsel persuasively argue that the courts below erred, (1) because they failed to indulge the legal presumption that the finding of the master upon the crucial question of fact was correct, and failed to apply to that finding the rule that it should not be set aside unless it clearly appeared from the evidence that it rested upon an error of law or an important mistake of fact (*Tilghman v. Proctor*, 125 U. S. 136, 148, 8 Sup. Ct. 894, 31 L. Ed. 664), and (2) because the evidence was not entirely plain and convincing beyond reasonable controversy (*Howland v. Blake*, 97 U. S. 624, 626, 24 L. Ed. 1027) that the deed was intended as a mortgage and was fraudulently obtained. The soundness of this contention depends entirely upon the evidence in the case. Every word of that evidence has been carefully read and weighed, and the entire testimony thus considered has convinced that it is clear that the master made a mistake in his finding of fact, and that the evidence is convincing beyond reasonable controversy that the deed was procured by fraudulent misrepresentation and was intended to be a mortgage. Much of the important evidence in this case was quoted and reviewed in the opinion of the Court of Appeals of the Indian Territory (*Guarantee Gold Bond Loan & Savings Company v. Edwards* [Ind. T.] 104 S. W. 624), and it is unnecessary to repeat it here.

While there was a decided conflict of the testimony of the witnesses upon the bald issue whether the instrument was intended as a deed or as a mortgage, these pregnant facts were conclusively established: Rachel A. Edwards was an ignorant Indian woman who could read and write with difficulty, and who knew little or nothing of the forms of conveyances. Dr. Simms, who procured the deed from her, was an intelligent man and the cashier of the bank. She wanted \$300 to pay to an attorney to locate her children upon valuable land to which they were entitled. She testified that she went to Dr. Simms and asked him to loan it to her, that he did so, and that she signed an instrument that he said was a mortgage upon her land, and that he said that upon the repayment of \$300 and interest her land would be free. He testified that

she came to him and asked to borrow from him \$300, that he told her it would take two or three days to perfect the loan, that she said that she must have the money upon that day, that he told her he would buy the land of her for \$600, that she said she wanted only \$300, that he told her she could leave the other \$300 on deposit in the bank, and that thereupon he drew and she signed the deed in consideration of \$600. The parties agree then that she asked a loan of \$300, and that she received \$300 and no more. Simms testified that \$300 more remained on deposit in his bank for her, and that he gave her a deposit slip for it, but she testified that she never heard of it until the taking of the testimony in this case, and his books of account failed to support his evidence. The land was worth from \$1,000 to \$2,000, probably \$2,000. The consideration which Simms wrote into the deed was \$2,450. Each of the parties whose names have been mentioned was corroborated by the testimony of others. But the established facts that the complainant was ignorant, and the cashier of the defendant informed; that she asked to borrow and wanted only \$300 and never obtained any more; that her property was worth at least three times, and probably seven times, that amount; that Simms does not claim that he bought her land either for the \$300 he actually paid her or for the \$2,450 which he wrote into her deed; that he never paid her the extra \$300 which he says was on deposit in the bank for her, and that his account books failed to show any credit of it to her—converge with compelling force to prove that the parties intended the instrument to be a mortgage, and that the master was mistaken in his finding upon this issue.

The decrees of the courts in the Indian Territory were amply sustained by the evidence and they must be affirmed. It is so ordered.

WAGONER NAT. BANK v. WELCH et al.

(Circuit Court of Appeals, Eighth Circuit. October 30, 1908.)

No. 2,733.

1. CHATTEL MORTGAGES (§ 162*)—MORTGAGED PERSONAL PROPERTY—MORTGAGEE HAS RIGHT TO POSSESSION AFTER DEFAULT UNTIL PAYMENT OF DEBT.

Where a mortgagee is rightfully in possession of mortgaged personal property after default, he has the right to retain possession until the mortgage debt is paid by the sale of the property or otherwise, and it is error to adjudge him to pay to the mortgagor the difference between the amount of the mortgage debt and the value of the mortgaged property.

The right of the mortgagor to the possession of the property is conditioned by the payment of the mortgage debt, but the right of the mortgagee to its possession is not conditioned by his payment of the difference between the value of the property and the amount of the mortgage debt.

[Ed. Note.—For other cases, see Chattel Mortgages, Cent. Dig. § 286; Dec. Dig. § 162.*]

2. JUDGMENT (§ 251*)—JUDGMENT MUST ACCORD WITH PLEADINGS AND PRAYERS THEREIN.

A valid judgment must accord with the pleadings, and must rest upon a determination of the issues which they present.

A judgment against a party to an action for the value of specific personal property may not be sustained upon pleadings which raise no

*For other cases see same topic & § NUMBER in Dec. & Am. Digs. 1907 to date, & Rep'r Indexes

issue concerning its value and contain no prayer for such a recovery, but demand a return of the property by the marshal in whose possession it is.

[Ed. Note.—For other cases, see Judgment, Cent. Dig. § 432; Dec. Dig. § 251.*]

(Syllabus by the Court.)

In Error to the United States Court of Appeals in the Indian Territory.

For opinion below, see 104 S. W. 610.

Robert F. Blair, for plaintiff in error.

W. S. Wolfenberger and Thomas A. Jenkins, for defendants in error.

Before SANBORN and HOOK, Circuit Judges, and PHILIPS, District Judge.

SANBORN, Circuit Judge. The Wagoner National Bank, a corporation, brought an action upon a promissory note for \$584.25 and upon a mortgage on certain personal property to secure the payment of this note, which the plaintiff alleged that the defendants made, and demanded judgment for the amount of the note, for \$50 damages, for costs, and for general relief. It filed an affidavit and undertaking in replevin, and caused a writ of replevin for the mortgaged property to be issued, and a portion of it was taken from the defendants under this writ and delivered to the bank. At the same time the bank caused a writ of attachment to issue under which the marshal seized certain property of the defendants which was not mortgaged. The defendants answered that they owed the plaintiff only \$350; that about February, 1903, they were coerced to sign the note and mortgage for \$584, but that the only amount they received therefor was \$350 paid to them about March 4, 1902; that the difference was usurious interest; that the allegations in the affidavit for replevin and in the affidavit for attachment were false; and they prayed that the property delivered to the plaintiff by virtue of the writ of replevin be returned to them, and for \$500 damages, that the writ of attachment be dissolved, and that the property seized by the marshal thereunder be returned to them, and that they recover \$500 damages for the wrongful suing out of the writ of attachment, the taking and detention of the property. The case was tried without a jury in the absence of the plaintiff. The court found that the note for \$584.25 was usurious and void except to the extent of \$350, that the mortgaged property replevined was worth \$505, that the plaintiff was entitled to the possession of property named in the mortgage to satisfy its just claim of \$350, that the defendants were entitled to recover of the plaintiff the difference between \$505 and \$350, or \$155, on account of the mortgaged property replevined, that no grounds for the issue of the attachment existed, that the value of the attached property was \$245, and that the defendants were entitled to recover \$155 plus this \$245, making in all \$400, and it rendered judgment against the bank for that amount. This judgment was

*For other cases see same topic & § NUMBER in Dec. & Am. Digs. 1907 to date, & Rep'r Indexes

affirmed by the Court of Appeals of the Indian Territory, and that affirmation is now challenged.

No evidence and no bill of exceptions appear in the record in this case, and the question is whether or not the judgment can be sustained upon the pleadings and the findings of the trial court. Two classes of personal property were involved in this action, mortgaged property worth \$505 seized under the writ of replevin and delivered to the mortgagee, the plaintiff, and property worth \$245 seized and held by the marshal under the writ of attachment. The court found that the plaintiff was entitled to the possession of property named in its mortgage to satisfy its just claim of \$350, and rendered judgment against it for \$155, the difference between the amount of its mortgage debt and the value of the mortgaged property. This was a radical error. The plaintiff, the mortgagee, had the right to the possession of the mortgaged property until its just claim of \$350 was paid. If the defendants did not pay it, the plaintiff had the right to sell so much of the mortgaged property as it was necessary to sell to realize the \$350 and the costs of the sale, and the extent of the right of the defendants was to recover the surplus, if any, remaining after the \$350 and costs were paid. Upon default in the payment of a debt secured by a mortgage, the burden is upon the mortgagor and not upon the mortgagee. His right to any of the mortgaged property is conditioned by his payment of the debt, either out of the proceeds of a sale of the property, or otherwise. The right of the mortgagee to enforce his lien upon and to collect his claim out of the mortgaged property is not conditioned by his payment of the difference between the amount of the debt due to him and the value of his security, and yet that was the effect of this judgment. It compelled the mortgagee to pay the difference between the amount of the mortgage debt and the value of the mortgaged property in order to collect anything out of the latter. The judgment should have been to the effect that the mortgagors pay to the mortgagee, within a time certain, the \$350 and costs of the replevin, that upon such payment the mortgaged property replevined be returned to the defendants, and that upon default in such payment so much of the replevined property as should be necessary be sold at public auction upon due notice to satisfy the plaintiff's claim of \$350 and costs, and that the remainder of the mortgaged property, or of its proceeds, if any, be returned to the defendants.

We turn to a consideration of the property attached. The court rendered judgment against the plaintiff for \$245, which it found to be the value of the defendants' property which was not mortgaged, but which was taken and held by the marshal under the writ of attachment. The record in reference to this property is that it was seized by the marshal under a writ of attachment sued out by the plaintiff in this case, that the defendants by an answer denied the allegations in the affidavit for the attachment and prayed that the attachment be dissolved, that the attached property be ordered to be restored to them, and that they recover of the plaintiff \$500 damages for the wrongful suing out of the attachment and the taking and detention of their property. The court found "that no grounds for the attachment existed, that the attached property was worth \$245," and rendered judgment against the plaintiff for that amount. The proposition is not denied that the defend-

ants, upon proper averments of the wrongful seizure of their property under the writ issued at the instance of the plaintiff and upon an allegation of its value, might have recovered of the plaintiff damages equivalent to its value. But their answer contained no averment of the value of the property and no prayer for any recovery of its value or of any damages on account thereof. On the other hand, it expressly prayed for an order that the attachment be dissolved, and that the property in the hands of the marshal, which consisted of domestic animals seized by him under the attachment, and which, according to the record, had never been delivered to the plaintiff but were still in the possession of the marshal, should be returned to them. In other words, the record contains no claim or issue presented by the pleadings relative to the value of the attached property or relating in any way to a recovery of the value thereof from the plaintiff, but a distinct prayer in the answer of the defendants that the specific property in the hands of the marshal under the writ be returned to the defendants. One may not bring his suit upon one cause of action and recover upon another. He may not base his cause of action upon a claim for an order that an attachment be dissolved and property in the possession of an officer thereunder be ordered to be restored to him, and recover the value of that property of a party to the suit as for conversion by him. In the case at bar the plaintiff was neither present nor represented at the trial of this action, and this salutary rule is of paramount importance in cases of this nature, because without it judgments might be rendered against parties upon claims of which they had never received notice. A valid judgment must accord with the allegations and prayers of the pleadings and determine the issues which they present. The judgment here rendered does neither and it cannot be sustained. *Reynolds v. Stockton*, 140 U. S. 254, 261, 266, 268, 11 Sup. Ct. 773, 35 L. Ed. 464, and cases there cited; *Munday v. Vail*, 34 N. J. Law, 418.

In the briefs of counsel in this case there is much discussion of the question whether or not this was an action of replevin or a simple suit upon a promissory note for money, but it is unnecessary to discuss or decide that question. The plaintiff set forth in its complaint its note, its mortgage, a specific description of the mortgaged property, its demand of payment of the note and the defendants' default, and prayed for judgment for the amount of the note, costs, and general relief, and the defendants joined issue upon and tried the question of the right of possession of the mortgaged property and of the attached property. These pleadings were sufficient in any event to sustain proper proceedings by the court to seize the mortgaged property and to apply it to the payment of the debt it secured, and, whatever the class or name of the action, the errors in the judgment which have been pointed out are fundamental.

The judgment is not sustained by the pleadings and the findings of the court, and it cannot stand. Accordingly, the judgments of the courts of the Indian Territory herein must be reversed, and the case must be remanded to the proper court of the state of Oklahoma with directions to grant a new trial, and it is so ordered.

WILSON v. HARTFORD FIRE INS. CO.

(Circuit Court of Appeals, Eighth Circuit. November 2, 1908.)

No. 2,789.

1. EXECUTORS AND ADMINISTRATORS (§ 521*) — APPOINTMENT — DIFFERENT STATES—NO PRIVITY BETWEEN.

There is no privity between the executors of the will of a decedent appointed in one state and an administrator with the same will annexed appointed in another state, nor between the administrators of the estate of an intestate appointed in different states.

[Ed. Note.—For other cases, see Executors and Administrators, Cent. Dig. § 2326; Dec. Dig. § 521.*]

2. EXECUTORS AND ADMINISTRATORS (§ 521*)—ESTOPPELS IN ONE STATE INEFFECTUAL IN ANOTHER.

Estoppels in favor of or against such executors or administrators in one state, by judgments or by the administration statutes of limitation of that state, do not bind or affect an administrator with the will annexed, or an administrator of an intestate appointed in another state, or a claimant against such representatives.

[Ed. Note.—For other cases, see Executors and Administrators, Cent. Dig. § 2326; Dec. Dig. § 521.*]

3. EXECUTORS AND ADMINISTRATORS (§ 521*)—DOMICILIARY ADMINISTRATION DOES NOT GOVERN ADMINISTRATION IN ANOTHER STATE.

Administration in the state of the domicile of the decedent does not govern the administration of the property of a decedent in any other state.

[Ed. Note.—For other cases, see Executors and Administrators, Cent. Dig. § 2326; Dec. Dig. § 521.*]

4. EXECUTORS AND ADMINISTRATORS (§ 521*)—CLAIM BARRED BY ADMINISTRATION STATUTES IN ONE STATE NOT THEREBY BARRED IN ANOTHER.

A claim against the estate of a decedent in the hands of an administrator with the will annexed in one state is not barred because it was not presented and has become barred against the estate of the decedent in the hands of the domiciliary executors of the same will in another state.

[Ed. Note.—For other cases, see Executors and Administrators, Cent. Dig. § 2326; Dec. Dig. § 521.*]

(Syllabus by the Court.)

In Error to the Circuit Court of the United States for the District of Kansas.

Charles Blood Smith (John E. Hessin, W. H. Rossington, and W. R. Smith, on the brief), for plaintiff in error.

Charles C. Arnold, for defendant in error.

Before SANBORN and VAN DEVANTER, Circuit Judges, and AMIDON, District Judge.

SANBORN, Circuit Judge. Is a claim against the estate of a deceased testator which is barred in the state of his domicile because it was not presented for allowance within the time fixed therefor by the administration statutes of that state thereby barred in another state in which an administrator with the will annexed is proceeding to administer upon property of the testator in the latter state? The court be-

*For other cases see same topic & § NUMBER in Dec. & Am. Digs. 1907 to date, & Rep'r Indexes

low answered this question in the negative, and this ruling is assigned as error.

Charles P. Dewey, a resident of the state of Illinois, made a will by which he appointed Chauncey Dewey and Charles T. Killen its executors, and on June 10, 1904, he died, owing the Hartford Fire Insurance Company, a corporation of the state of Connecticut, \$21,500 and some interest. His will was proved in the probate court of Cook county, the executors qualified therein, and such proceedings were had that the time within which, under the administration statutes of Illinois, such a claim could be presented for allowance against the estate, expired without any presentation of the claim. The laws of Illinois provided that in such a case claims not presented should be forever barred. Meanwhile the defendant below, Clyde Wilson, had been appointed administrator with the will annexed of the estate of Dewey in the state of Kansas by the probate court of Riley county in that state, and he was proceeding to administer upon the property of the deceased therein. After the time to present its claim for allowance in Illinois had expired, and before the time for its presentation in Kansas, in accordance with the terms of the administration statutes of that state, had run, the insurance company brought an action in the court below against the Kansas administrator to recover the amount of its claim out of the property of the deceased in that state. The contention of counsel for the administrator is that the claim of the insurance company is barred in Illinois, that the estate of the testator is governed by the laws of that state because it was the state of his domicile, that there is a privity between the Illinois executors and the Kansas administrator, and that as the claim is barred against the former it is also barred as against the latter. But the property of the estate which is situated in Kansas is not controlled nor is its administration or distribution governed by the laws of the domicile of the testator. The laws of Illinois have no extraterritorial force, and they are powerless in the state of Kansas. The property of the estate of the testator in that state is subject to and it must be administered and distributed in accordance with the laws of the state of its situs. Under the statutes of Kansas the property of deceased persons in that state, whether they were residents or nonresidents, is subject to the payment of their debts due to citizens of other states to the same extent as it is to the payment of those owing to its own citizens (Gen. St. Kan. 1901, §§ 2825, 2891, 2893, 2907, 2503), and there is a law of that state which reads:

"When administration shall be granted in this state on the estate of any person who at the time of his decease was an inhabitant of any other state or country, such estate shall be administered and distributed according to the laws of this state; and the balance in the hands of the administrator on final settlement, to which the foreign executor or administrator of said deceased may be entitled, shall be paid over to such foreign executor or administrator upon the order of the court."

The effect of this legislation is that the application of the Kansas property of a deceased nonresident of that state, whether testate or intestate, to the payment of his debts, is governed exclusively by the laws of Kansas, and the laws of his domicile can have no effect upon any part of that property until those debts have been ascertained and

paid. The only part of the Kansas property upon which the statutes of the domicile of this decedent may have effect is the residue after the payment of the debts, and upon that, not because of the force of the laws of Illinois, but because the statute of Kansas permits that residue to be sent to the foreign executor or administrator by the express provision of section 2980. Thus it conclusively appears that the administration and distribution of the Kansas property of deceased nonresidents is governed by the laws of Kansas, and not by the laws of their domicile.

Is there such a privity between the domiciliary executors of the will of a deceased person and the administrator with the will annexed of the property of such a person in another state that a bar of a claim against the former bars it against the latter? Section 4450 of the General Statutes of Kansas of 1901 reads:

"Where the cause of action has arisen in another state or country, between non-residents of this state, and by the laws of the state or country where the cause of action arose an action cannot be maintained thereon by reason of lapse of time, no action maintained thereon in this state."

But has the cause of action which the insurance company here presses arisen in another state or country? A proceeding in a probate court to administer upon the estate of a deceased person is a proceeding in rem, not in personam. The property within the jurisdiction of the court is the defendant, the executor or administrator is its representative, and all claiming any interest in that property under the deceased are parties to the proceeding. *Grignon's Lessee v. Astor*, 2 How. 319, 337, 11 L. Ed. 283; *Sheldon's Lessee v. Newton*, 3 Ohio St. 494, 503. The probate court of Illinois and the executors which it appointed had no jurisdiction to administer or to distribute any property beyond the limits of that state, because the statutes which gave them their authority were ineffective beyond its boundaries. The property of the estate of the deceased in that state, and that alone, therefore, was the defendant, and the executors represented no other. In the proceeding in Kansas the real defendant is the property of the estate of the decedent in that state, and the administrator with the will annexed is the representative of that property and of no other. In other words, the defendant in the administration in Illinois was the property of the deceased in that state, which alone the executors represented, and not the property of the estate in Kansas; and the defendant in the administration in Kansas is the property of the deceased in that state, which alone the administrator with the will annexed represents. Now, no cause of action against the deceased arose in his lifetime, because his obligations to the insurance company did not mature until after his death. No cause of action against his property in Kansas, the only defendant in the instant suit, arose after his death either in the state of Illinois or in any other jurisdiction outside of the state of Kansas, because no court or officer beyond the limits of Kansas ever had any jurisdiction to adjudge or enforce any such cause. The only cause of action, therefore, which was barred by the failure of the insurance company to present its claim in due time in Illinois was its cause of action against the property of the deceased

in that state. That cause of action never existed, and never was judicable in Kansas, so that in the state of Kansas the bar of the Illinois administration statutes in no way affected it. The insurance company's cause of action against the property of the estate of the deceased in Kansas never existed and never was judicable in the state of Illinois, and the bar of its cause of action against the property of the estate of the deceased in Illinois by the administration statutes of that state in no way limited or affected its cause of action against the property of the estate of the deceased in Kansas.

But counsel say that the administrator with the will annexed appointed in Kansas is in privity with the executors appointed in Illinois, and, as the insurance company is estopped by the statute of limitations of Illinois from enforcing its claim against the former, it is also estopped from enforcing it against the latter. "The term 'privity' denotes mutual or successive relationship to the same rights of property." Greenleaf on Evidence (16th Ed.) § 189. Lord Coke divides privies into three classes—privies in estate, privies in law, and privies in blood. The only principle upon which the doctrine of estoppel applies to one party because of his privity with another is that the party claiming through another is estopped by that which estopped that other respecting the same subject-matter. Thus the executors and the administrator with the will annexed are in privity with the testator, and are estopped by judgments and prescriptions that prevail for or against him, because they each derived the property they are respectively administering from him. But there is no privity between the Illinois executors and the Kansas administrator, because none of the property which the latter is administering was derived from the former, and none of the property which the former is administering was derived from the latter, so that an estoppel against or in favor of the latter does not relate to the same subject-matter with which the former is dealing, and they are not privies in estate. They received their authority from different sovereignties over different property, they are accountable to different courts which are acting under different laws, the authority of the executors is paramount and that of the administrator is nothing in Illinois, the authority of the administrator is paramount and the executors are without authority in Kansas, hence they are not privies in law. They are certainly not privies in blood, and the result is that they are not privies at all. The suggestion that in some incomprehensible way the domiciliary administration in Illinois is so primary and that in Kansas so ancillary that an estoppel of a claimant to urge his demand in the former proceeding estops him in the latter is not tenable. Under the statutes of Kansas, to which we have adverted, the administration in that state can never become ancillary to that in Illinois until the probate court in Kansas has fully paid out of the property of the estate in that state all the claims there presented and allowed, and has ordered the residue to be sent to the executors in Illinois under section 2980, Kan. St. 1901, and then it will become ancillary only to the extent of that residue. Until that order is made the administration in Kansas is independent of and coordinate with that in Illinois, and estoppels between the creditors and the representatives of the property of the estate in one jurisdiction

are ineffectual for or against the representatives of the property of the estate in the other.

In *Aspden v. Nixon*, 4 How. 467, 468, 497, 498, 11 L. Ed. 1059, Henry Nixon, one of the executors named in the will of Matthias Aspden, a resident of England, proved the will and qualified as executor in England and in the state of Pennsylvania. He died, and successory executors were appointed, one in England and one in Pennsylvania. Administrators of the estate of John Aspden sued the executor in England for the property of the estate of Matthias, and the High Court of Chancery dismissed their bill. The Pennsylvania administrator of the estate of John then sued the Pennsylvania executor of the estate of Matthias for the property of the estate upon the same ground of action. The executor pleaded *res adjudicata*, but the Supreme Court overruled the plea on the ground that the property involved and the representatives of the estates in the two jurisdictions differed and there was no privity between them.

In *Hill v. Tucker*, 13 How. 458, 461, 467, 14 L. Ed. 223, the testator, a resident of Virginia, named three executors in his will, two of whom qualified in Virginia and one in Louisiana. A claimant against his estate recovered a judgment against the Virginia executors as such, and relied upon it to sustain an action in Louisiana against the executor in that state. The Supreme Court said, "Notwithstanding the privity that there is between executors of a testator, we do not think that a judgment obtained against one of several executors would be conclusive of the demand against another executor, qualified in a different state from that in which the judgment was rendered," but added that under the rule in the state courts of Louisiana (*Jackson v. Tiernan*; 15 La. 485) such a judgment was admissible in evidence to meet the plea of prescription.

In *Borer v. Chapman*, 119 U. S. 587, 590, 591, 598, 599, 7 Sup. Ct. 342, 30 L. Ed. 532, a testator who resided in Minnesota, but the bulk of whose property was situated in California, named two executors in his will, one a resident of Minnesota, the other a resident of California. The will was proved in each state. The Minnesota executor accepted the trust in that state, but notice to creditors was not published and claims against the estate in Minnesota were not barred in accordance with its administration statutes. The California executor qualified in his state, notice to creditors was there published, all claims not presented were barred under the provisions of the statutes of California, the estate in that state was fully administered, and the executor was discharged. An action at law was brought in the state of Minnesota against the Minnesota executor upon a claim which had not been presented in California and which was barred under the administration statutes of that state, and the defendant pleaded that the cause of action was barred in Minnesota by virtue of the administration in California, but the Supreme Court sustained a judgment for the claimant, and said:

"If he had chosen, he could have proven his claim there and obtained judgment; but he had the right to await the result of the settlement of that administration, and look to such assets of Gordon as he could subsequently

find in Minnesota, whether originally found there or brought there from California by the executors or legatees of Gordon's estate."

In *Brown v. Fletcher*, 210 U. S. 82, 28 Sup. Ct. 702, 704, 705, 52 L. Ed. 966, *Fletcher*, a resident of Michigan, died testate, leaving a suit pending against him in Massachusetts and property in that state worth about \$300. His will was proved and the executors qualified in Michigan, and an administrator with the will annexed was appointed in Massachusetts. The suit was revived against this administrator, and resulted in a decree against him for more than \$400,000. This decree of the Massachusetts court was filed in the probate court in Michigan as evidence of a claim against the estate of *Fletcher* in that state, upon the ground that the executors in Michigan were in that privity with the administrator with the will annexed in Massachusetts that a decree against the latter was conclusive evidence of the debt against the former; but the Supreme Court held that there was no privity between them, and that an estoppel of the administrator with the will annexed in one jurisdiction constituted no estoppel of the executors of the will in another state. The converse of this proposition is equally true, and our conclusions are: There is no privity between the executors of the will of a decedent appointed in one state and an administrator with the same will annexed appointed in another state, nor between administrators of the estate of the same decedent appointed in different states. Estoppels in favor of or against such executors or administrators in one state by judgments or by the administration statutes of limitation of that state do not bind or affect an administrator with the will annexed, or an administrator appointed in another state, or a claimant against such representatives. Administration in the state of the domicile of the decedent does not govern the administration of the property of the decedent in any other state, and a claim against the estate of the decedent in the hands of an administrator with the will annexed in one state is not barred because it was not presented and has become barred against the estate of the decedent in the hands of the domiciliary executors of the same will in another state. *Vaughan v. Northup*, 15 Pet. 1, 5, 10 L. Ed. 639; *Aspden v. Nixon*, 4 How. 466, 468, 497, 498, 11 L. Ed. 1059; *Stacy v. Thrasher*, 6 How. 44, 58, 60, 12 L. Ed. 337; *Hill v. Tucker*, 13 How. 458, 461, 467, 14 L. Ed. 223; *McLean v. Meek*, 18 How. 16, 17, 18, 15 L. Ed. 277; *Borer v. Chapman*, 119 U. S. 587, 590, 591, 598, 599, 7 Sup. Ct. 342, 30 L. Ed. 532; *Johnson v. Powers*, 139 U. S. 156, 157, 158, 159, 11 Sup. Ct. 525; 35 L. Ed. 112; *Brown v. Fletcher*, 210 U. S. 82, 28 Sup. Ct. 702, 704, 705, 52 L. Ed. 966.

Counsel for the plaintiff in error have cited opinions of courts of eminent ability that are not in accord with these propositions. *Sanborn v. Perry*, 86 Wis. 361, 56 N. W. 337; *Latine v. Clements*, 3 Ga. 426; *Hunt v. Fay*, 7 Vt. 170; *Baldwin v. Rice*, 44 Misc. Rep. 64, 89 N. Y. Supp. 738; *Durston v. Pollock*, 91 Iowa, 668, 60 N. W. 221; *Harrison v. Stacy*, Adm'r, 6 Rob. (La.) 15. These decisions have been thoughtfully considered, but the more cogent reasons and the supreme authority sustain the views which have been expressed, and they must prevail.

The judgment below is accordingly affirmed.

In re HECOX.

HECOX v. ROLLESTONE.

(Circuit Court of Appeals, Eighth Circuit. November 7, 1908.)

No. 89 Original.

No. 2,718.

1. BANKRUPTCY (§ 441*)—REVIEW OF PROCEEDINGS—PETITION FOR REVISION—“PROCEEDING IN BANKRUPTCY.”

A petition by a trustee in bankruptcy to a court of bankruptcy for a summary order on a receiver of a state court to deliver property to the petitioner is a proceeding in bankruptcy, and the order made thereon is reviewable by the Circuit Court of Appeals in matter of law on a petition to revise under Bankr. Act July 1, 1898, c. 541, § 24b, 30 Stat. 553 (U. S. Comp. St. 1901, p. 3432).

[Ed. Note.—For other cases, see Bankruptcy, Dec. Dig. § 441.*

For other definitions, see Words and Phrases, vol. 1, pp. 703-704.

Appeal and review in bankruptcy cases, see note to In re Eggert, 43 C. C. A. 9.]

2. BANKRUPTCY (§ 100*)—ADJUDICATION—COLLATERAL ATTACK.

An adjudication of bankruptcy based on a finding that because of insolvency a receiver was appointed for the property of the alleged bankrupt under the laws of a state, which is made an act of bankruptcy by Bankr. Act July 1, 1898, c. 541, § 3a (4), 30 Stat. 546 (U. S. Comp. St. 1901, p. 3422), as amended by Act Feb. 5, 1903, c. 487, § 2, 32 Stat. 797 (U. S. Comp. St. Supp. 1907, p. 1025), is conclusive as to such fact, and cannot be collaterally attacked.

[Ed. Note.—For other cases, see Bankruptcy, Cent. Dig. § 142; Dec. Dig. § 100.*]

3. BANKRUPTCY (§ 293*)—RIGHTS OF TRUSTEE—PROPERTY IN CUSTODY OF RECEIVER.

On an adjudication in bankruptcy and the appointment of a trustee, he is entitled to the possession of property of the bankrupt in the possession of a receiver appointed by a state court within four months, and, if such right is not recognized by the receiver or the court which appointed him, it is competent for, and the duty of, the bankruptcy court to enforce it.

[Ed. Note.—For other cases, see Bankruptcy, Dec. Dig. § 293.*]

Appeal from the District Court of the United States for the District of Colorado.

On Petition for Review.

Ernest Morris, for appellant.

L. F. Twitchell and John M. Woy (Frank C. Goudy, on the brief), for respondent.

Before VAN DEVANTER and ADAMS, Circuit Judges, and PHILIPS, District Judge.

PHILIPS, District Judge. The question presented for decision on this record arises out of a controversy between a trustee in bankruptcy and a receiver appointed by a state court respecting the right to the custody of certain property of the bankrupt. The Economic Gold Extraction Company, a corporation, in an involuntary proceeding, was

*For other cases see same topic & § NUMBER in Dec. & Am. Digs. 1907 to date, & Rep'r Indexes

duly adjudged a bankrupt, on the ground that five days prior to the filing of the petition in bankruptcy one A. A. Rolleston was put in possession of the property of the said company as receiver under the laws of the state of Colorado, in certain proceedings pending in the district court for the city and county of Denver.

The trustee in bankruptcy, under order of the referee in bankruptcy to whom the petition theretofore had been referred, applied to said state court for an order directing its receiver to turn over to the trustee the property of the bankrupt estate in his possession as receiver. This order the state court refused to make. Thereupon the trustee reported the refusal to the United States District Court, and asked for an order on the receiver to deliver said property to the trustee for administration in bankruptcy. This petition to the court of bankruptcy, inter alia, alleged that the said receiver had been appointed in a proceeding to foreclose a certain mortgage claimed to cover the property in question, but alleged that said mortgage was invalid. The receiver entered his appearance to this petition, and made answer, alleging, among other things, that the receiver was not appointed on account of the insolvency of the debtor. But the answer admitted that the bill in the state court alleged "that there are no funds arising from any insurance to reconstruct said mill (covered by the mortgage), or to stand in lieu thereof as security for said bonds, and that the defendant the Economic Gold Extraction Company is insolvent."

In affidavits filed, pro and con, by the parties, question was raised as to whether or not certain of the property claimed was covered by the mortgage. The court ruled that, inasmuch as the state court had first acquired jurisdiction over the res, the trustee should contest the matter by plenary suit against the receiver in the proper court. It therefore, declined to make the order requested.

On this state of the record the trustee, to preserve his right of having the matter reviewed, filed in this court a petition for review in matter of law, and also brought the case here by appeal, a course of practice recognized in this jurisdiction. In *re* McKenzie, 142 Fed. 383, 73 C. C. A. 483; In *re* Holmes, 142 Fed. 391, 73 C. C. A. 491. Judge Lurton, speaking for the Court of Appeals of the Sixth Circuit, in *Re* McMahon, 147 Fed., loc. cit. 689, 77 C. C. A. 673, said:

"The distinction between cases which are 'proceedings in bankruptcy' under section 24b (Act July 1, 1898, c. 541, 30 Stat. 553 [U. S. Comp. St. 1901, p. 3432]) and those which are 'controversies arising in bankruptcy proceedings' and appealable under the general appellate jurisdiction of the court as confirmed by section 24a is not always clear nor easily stated. Between *Hewitt v. Berlin Machine Works*, 194 U. S. 296, 24 Sup. Ct. 390, 48 L. Ed. 936, and *First National Bank of Chicago v. Chicago Title & Trust Company*, 198 U. S. 280, 25 Sup. Ct. 693, 49 L. Ed. 1051, there is this distinction: In the first case the stranger voluntarily came in and set up a claim against property in possession of the bankrupt's trustee. Very clearly that made one of those independent controversies which may arise in a bankruptcy proceeding or in any other where the res is in custodia legis, and was appealable under section 24a. In the latter case the same kind of issue arose, but it arose upon the application of the trustee for an order of sale, and as incident to that the determination of a claim against the property held by one not a party to the proceeding. The latter is plainly held to be a 'proceeding in bankruptcy' not appealable, but reviewable in matters of law only upon an appeal to the super-

visory powers of the Court of Appeals under section 24b. The distinction we recognize and apply in this case by holding that the proper and only mode of correcting error in the case was through the supervisory powers of this court, and that the petitioner resorted to the right remedy though he had no wrong to redress."

As the case at bar is that of a petition for a summary order on the receiver to deliver property to the trustee in bankruptcy, which order was refused by the District Court solely on a question of law, the case is one presenting a controversy "arising in bankruptcy" under section 24b of the bankrupt act, and is reviewable in matter of law.

The radical error in the ruling of the District Court and the vice in the position assumed by counsel for the receiver before this court consist in undertaking collaterally to controvert the ground of adjudication in bankruptcy. That adjudication determined that the bankrupt was insolvent, and while insolvent, within four months of the filing of the petition in involuntary bankruptcy, and because of its insolvency, a receiver had been put in charge of its property by order of the state court. By the amendment to the bankrupt act of July 1, 1898, c. 541, § 3a (4), 30 Stat. 546 (U. S. Comp. St. 1901, p. 3422), by Act Feb. 5, 1903, c. 487, § 2, 32 Stat. 797 (U. S. Comp. St. Supp. 1907, p. 1025), it is declared to be an act of bankruptcy "because of insolvency a receiver or trustee have been put in charge of its property under the laws of a state, a territory, or of the United States." Until avoided in a direct proceeding therefor, that adjudication was binding and conclusive on the bankrupt and creditors, as much so as a judgment, inter partes, on due hearing in a court of competent jurisdiction. *In re American Brewing Company*, 112 Fed. 752, 50 C. C. A. 517; *In re Knight* (D. C.) 125 Fed. 35; *In re First National Bank*, 152 Fed. 65, 81 C. C. A. 260.

By operation of law, on the adjudication in bankruptcy and the selection and qualification of a trustee, all right, title, and interest of the bankrupt in and to any and all property passed to and vested in such trustee. The scheme as well as the policy of the bankrupt act is that the collecting, marshaling, administration, and distribution of the bankrupt's estate shall reside exclusively in the court of bankruptcy. As the bankrupt act is a national law, enacted pursuant to the power vested by the Constitution in Congress, it is a paramount law of the land, to which all state authority, legislative and judicial, must submit. As the receiver in question was appointed by the state court within four months next preceding the filing of the petition in bankruptcy, the debtor being insolvent, his appointment constituted an act of bankruptcy. In contemplation of the bankrupt act, in so far as concerned his right to the custody of the property of the bankrupt, he stood as if he had never been appointed by the state court. In such situation, as he holds the property not in his own right, but solely in his claimed official capacity, it was his duty, on notification and demand by the trustee in bankruptcy, to deliver the property to him. But inasmuch as he was the appointee of the state court, as a mere act of courtesy, sometimes, but hardly accurately, termed "judicial comity," the bankrupt court in the first instance directed the trustee to prefer a request to the state court for an order on its receiver to deliver the

property in his custody to the trustee. In such case, if the state court decline to reciprocate the consideration thus paid to its dignity, the law is well settled that it is then competent for, and the duty of, the bankrupt court to order the receiver to deliver the property over to the trustee, and he would be in contempt if he refuse to comply therewith. Controlling authorities affirm the foregoing propositions. *Bryan v. Bernheimer*, 181 U. S. 188, 195, 196, 21 Sup. Ct. 557, 45 L. Ed. 814; *Randolph v. Scruggs*, 190 U. S. 533, 537, 538, 23 Sup. Ct. 710, 47 L. Ed. 1165; *Watts v. Sachs*, 190 U. S. 1, 23 Sup. Ct. 718, 47 L. Ed. 933; *In re Schermerhorn*, 145 Fed. 341, 76 C. C. A. 215; *In re Knight (D. C.)* 125 Fed. 35; *In re Kaplan (D. C.)* 144 Fed. 159; *Hooks v. Aldridge*, 145 Fed. 865, 869, 76 C. C. A. 409; *Loveland on Bankruptcy (3d Ed.)* 116, 117; *Collier on Bankruptcy (6th Ed.)* 51; 1 *Remington on Bankruptcy*, §§ 1605, 1617.

If the mortgagee who proceeded in the state court has a valid lien on or claim to the property in question, he can and should assert it in the court of bankruptcy. And it will be the duty of the latter court to recognize and enforce it in an appropriate proceeding therefor; and, if the receiver have a just claim for his services while in custody of the property, he can present it, if he so desire, to the court of bankruptcy for adjustment, where the rights and interests of all the parties concerned in the estate can be properly protected.

It results that the District Court erred in denying the petition of the trustee. The petition for review is sustained, the appeal is dismissed, and the cause is remanded to the District Court with directions to set aside its said order, and to proceed further in the matter not inconsistent with this opinion. As there is but one transcript filed and record made in this court, the costs will be taxed against said A. A. Rollestone.

CHICAGO, R. I. & P. RY. CO. v. BALDWIN.

(Circuit Court of Appeals, Eighth Circuit. October 31, 1908.)

No. 2,803.

1. RAILROADS (§ 383*)—INJURY TO PERSON ON TRACK—CONTRIBUTORY NEGLIGENCE—FACTS HELD TO CONCLUSIVELY ESTABLISH.

A superintendent who had been in charge of some repairing of the Omaha Bridge of the Union Pacific Railroad Company for two months was overtaken and knocked off the north track thereon, which was used for west-bound trains, by a Rock Island engine which came up behind him at a negligently rapid speed while an east-bound train was passing on the south track. He was walking west on the bridge about 300 feet from the east end of it about 10 minutes after 7 on a morning in June. Floor beams from 6 to 10 inches in width extended upon each side beyond the ties, the rails and the space covered by passing trains at regular intervals of about 24 feet to substantial railings, and pedestrians could step out upon these beams to the railings and stand there safely while two trains were passing at the same time. The superintendent was killed by the fall from the bridge. At any time while he was walking the last 100 feet and was necessarily passing at least 3 of these extended beams he could have seen the Rock Island train approaching if he had looked behind him.

Held, these facts conclusively established that the decedent was guilty

*For other cases see same topic & § NUMBER in Dec. & Am. Digs. 1907 to date, & Rep'r Indexes

of contributory negligence, and the court should have instructed the jury that the administratrix of his estate could not recover damages on account of his death.

[Ed. Note.—For other cases, see Railroads, Cent. Dig. §§ 1305–1307; Dec. Dig. § 383.*]

2. NEGLIGENCE (§ 80*)—NEGLIGENCE OF DEFENDANT NO EXCUSE FOR CONTRIBUTORY NEGLIGENCE OF PLAINTIFF.

Under the common law one whose negligence directly contributes to his injury cannot recover damages of another whose negligence concurred to cause it. The negligence of the latter is no excuse for the contributory negligence of the former.

[Ed. Note.—For other cases, see Negligence, Cent. Dig. § 84; Dec. Dig. § 80.*]

3. NEGLIGENCE (§ 66*)—FAILURE TO DILIGENTLY USE SENSES TO AVOID THREATENED DANGER IS CONTRIBUTORY NEGLIGENCE.

Where a diligent use of the senses by the person injured would have avoided a known or apprehended danger, a failure to use them is, under ordinary circumstances, contributory negligence.

[Ed. Note.—For other cases, see Negligence, Cent. Dig. § 86; Dec. Dig. § 66.*]

4. NEGLIGENCE (§ 136*)—TRIAL—DUTY TO DIRECT VERDICT WHERE FAILURE TO USE SENSES CONCLUSIVELY PROVED.

Where such a failure to use the senses is established by undisputed or conclusive evidence, it is the duty of the trial court to instruct the jury that there can be no recovery of damages on account of the injury.

[Ed. Note.—For other cases, see Negligence, Cent. Dig. § 291; Dec. Dig. § 136.*]

(Syllabus by the Court.)

In Error to the Circuit Court of the United States for the District of Nebraska.

J. L. Parrish (W. D. McHugh and Carroll Wright, on the brief), for plaintiff in error.

W. J. Connell, for defendant in error.

Before SANBORN and VAN DEVANTER, Circuit Judges.

SANBORN, Circuit Judge. This is an action by the administratrix of the estate of Henry D. Baldwin, deceased, under a statute of Iowa, to recover damages of the Rock Island Company for causing his death by its alleged negligence. In this court the negligence of the company is conceded, and the first question presented is whether or not the evidence so conclusively proves that the decedent was guilty of contributory negligence that the court should have instructed the jury to return a verdict for the company. The defendant introduced no evidence, and the facts relative to the issue were established without dispute. Mr. Baldwin was an employé of the Union Pacific Railway Company, and he was superintending the repair of its bridge across the Missouri river at Omaha. He had been engaged in the discharge of this duty from April until June 4, 1906, when a train of the Rock Island Company knocked him off the bridge and killed him. This bridge was about 1,700 feet long. There were two railroad tracks upon it. The north one was used by west-bound and the south

*For other cases see same topic & § NUMBER in Dec. & Am. Digs. 1907 to date, & Rep'r Indexes

one by east-bound trains. Floor beams from 6 to 10 inches in width extended beyond the portion of the bridge covered by the ties, the rails and the passing cars to substantial railings on each side of the bridge, and employes could safely step out upon these beams and stand by the railings when trains were passing upon both tracks. These extended floor beams had been placed at regular intervals and were between 24 and 25 feet apart. Several railroad companies, and among them the Rock Island Company, rightfully ran their trains across the bridge, and about 100 trains passed over it daily between 7 in the morning and 6 in the evening. There was an order in force that trains should not pass over the bridge at a greater speed than 4 miles an hour, and the train which struck the deceased ran over it at a speed of about 20 miles an hour. He was walking west on the north track at a point about 300 feet west of the east end of the bridge about 10 minutes after 7 in the morning when the engine of the west-bound Rock Island train overtook him and killed him. The bridge and the tracks upon it and east of it were straight for about two miles, the view along them for at least one mile from the place of the accident was unobstructed, and this approaching train could have been seen by the decedent for at least a mile if he had looked along the track upon which it came. When he was about 60 feet from the east end of the bridge he met one of the witnesses, and when he was about 200 feet from it he met another. He was then walking between the tracks or on the south track, and an east-bound train of the Northwestern Railroad Company, consisting of an engine and 5 or 6 cars, was coming over the bridge upon the south track. Each of the two witnesses saw both the Rock Island train which was coming to meet them, and the Northwestern train which was coming behind them, before these trains came dangerously near them. The two trains passed each other on the east part of the bridge, but the evidence does not show clearly how near the east end. The Rock Island Company's engine struck the deceased about 300 feet from the east end of the bridge. He must therefore have walked about 100 feet after the witness who met him 200 feet from the end of the bridge left him and went on toward the east. This witness testified that when he had walked about 25 feet from the place of their meeting he saw the Northwestern train coming behind him, and shortly after observing it he saw the Rock Island train coming towards him, and he then ran, crossed the south track, and went off the east end of the bridge as the Rock Island train entered upon it. Both trains must have been in full view of Baldwin when he left this witness. He walked about 100 feet and then the Rock Island engine overtook him. If he walked at the rate of 3 miles an hour and the train ran 20 miles an hour, it must have been within 200 feet of him when he parted from the witness. The latter walked 25 feet and ran 175 feet, and the Rock Island engine was then entering upon the bridge. If this witness moved but 5 miles an hour and the train 20 miles an hour, the latter could not have been more than 1,100 feet from the two men when they separated. The view of the track was and continued to be unobstructed, except by this approaching train, for the distance of at least a mile east of them. As the evidence does not clearly show at what point the two trains passed

each other, the fact that they passed so near to the place where Baldwin was overtaken that he could not have saved himself by stepping on to the south track is assumed. But this did not relieve him of the duty to use his senses to protect himself from the train that was coming upon the north track. He knew that the north track was used for trains which must come up behind him. If he had looked to the east when he parted from the last witness who met him, he could not have failed to see the Rock Island train approaching. Between the point where these two men parted and the place where he was overtaken there were at least three extended floor beams where he could have stepped out to the railing and have waited safely until both trains had passed. The bridge and the railroad tracks upon it in such frequent use were constant warnings of the danger of coming trains. It was his duty to exercise ordinary care to protect himself from them, and the exercise of that care required him to be so alert and watchful for his own welfare that trains, coming in plain view for the distance of a mile, which he could escape by looking behind him and by moving with reasonable celerity from their track, should not strike him upon it. Under these undisputed facts there is no escape from the conclusion that if the decedent had looked behind him at any time when he was walking the first 75 of the last 100 feet he must have seen the fatal engine approaching him, and he could easily have stepped out upon an extended floor beam and have escaped it. If he did not look he was guilty of negligence, and if he looked and did not step out upon one of these beams to the railing beyond reach of the engine he was likewise guilty, and in either event his negligence contributed to his injury, for if he had exercised ordinary care to look and to act he would have escaped the accident.

In *Missouri Pacific Ry. Co. v. Moseley*, 57 Fed. 921, 925, 6 C. C. A. 641, 645, the plaintiff was overtaken and injured by an engine which came up behind him while he was walking upon one railroad track and the roar of a train upon an adjoining track had rendered his hearing useless, and we held that this fact made the frequent and diligent use of his eyes to see what was coming behind him more imperative, and that as his view of the engine approaching behind him had been unobstructed he was conclusively guilty of contributory negligence and could not recover. Under the common law one whose negligence directly contributed to his injury cannot recover damages of another whose negligence concurred to cause it. The negligence of the latter is no excuse for the contributory negligence of the former. *Railroad Company v. Houston*, 95 U. S. 697, 702, 24 L. Ed. 542; *Schofield v. Railroad Company*, 114 U. S. 615, 5 Sup. Ct. 1125, 29 L. Ed. 224; *Northern Pacific Railroad Co. v. Freeman*, 174 U. S. 379, 383, 19 Sup. Ct. 763, 43 L. Ed. 1014; *Blount v. Grand Trunk Ry. Co.*, 61 Fed. 375, 9 C. C. A. 526; *Pyle v. Clark*, 79 Fed. 744, 25 C. C. A. 190; *Chicago & Northwestern Ry. Co. v. Andrews*, 130 Fed. 65, 73, 74, 64 C. C. A. 399, 407, 408; *Garlich v. Northern Pacific Railroad Co.*, 131 Fed. 837, 840, 67 C. C. A. 237, 240.

Where a diligent use of the senses by the person injured would have avoided a known or apprehended danger, a failure to use them is, under ordinary circumstances, contributory negligence; and, where such

a failure is established by undisputed or conclusive evidence, it is the duty of the trial court to instruct the jury that there can be no recovery of damages on account of the injury. *Railroad Company v. Houston*, 95 U. S. 697, 702, 24 L. Ed. 542; *Schofield v. Railroad Company*, 114 U. S. 615, 5 Sup. Ct. 1125, 29 L. Ed. 224; *Southern Pacific Co. v. Pool*, 160 U. S. 438, 440, 16 Sup. Ct. 338, 40 L. Ed. 485; *Patton v. Railroad Company*, 179 U. S. 658, 660, 21 Sup. Ct. 275, 45 L. Ed. 361; *Missouri Pacific Company v. Moseley*, 57 Fed. 921, 925, 6 C. C. A. 641, 645; *Chicago Great Western Ry. Co. v. Roddy*, 131 Fed. 712, 713, 65 C. C. A. 470, 471; *Gilbert v. Burlington & C. R. Ry. Co.*, 128 Fed. 529, 532, 533, 63 C. C. A. 27, 30, 31; *Clark v. Zarniko*, 106 Fed. 607, 608, 45 C. C. A. 494, 496; *Chicago & Northwestern Ry. Co. v. Andrews*, 130 Fed. 65, 73, 74, 64 C. C. A. 399, 407, 408; *Western Union Telegraph Co. v. Baker*, 140 Fed. 315, 319, 72 C. C. A. 87, 91.

The judgment must accordingly be reversed, and the case remanded to the court below with instructions to grant a new trial, and it is so ordered.

KIMBALL v. APSEY.

(Circuit Court of Appeals, First Circuit. November 10, 1908.)

No. 780.

1. BANKS AND BANKING (§ 246*)—NATIONAL BANKS—WITHDRAWAL OF STOCKHOLDER.

Under Act July 12, 1882, c. 290, § 5, 22 Stat. 163 (U. S. Comp. St. 1901, p. 3458), which provides that when a national bank has amended its charter, for the purpose of renewing the same, as therein provided, and has obtained a certificate of approval from the Comptroller, "any shareholder not assenting to such amendment may give notice in writing to the directors, within 30 days from the date of the certificate of approval, of his desire to withdraw from said association, in which case he shall be entitled to receive from said banking association the value of the shares so held by him, to be ascertained by an appraisal," etc., a shareholder ceases to be such on giving notice of withdrawal within the required time.

[Ed. Note.—For other cases, see *Banks and Banking*, Dec. Dig. § 246.*

2. BANKS AND BANKING (§ 248*)—NATIONAL BANKS—WITHDRAWAL OF STOCKHOLDER—LIABILITY FOR ASSESSMENT.

Where a stockholder in a national bank served notice of withdrawal on a renewal of its charter, as required by Act July 12, 1882, c. 290, § 5, 22 Stat. 163 (U. S. Comp. St. 1901, p. 3458), appointed an appraiser on his behalf and took all reasonable steps to obtain an appraisal of and payment for his shares as therein provided, and thereafter refused to accept dividends on his stock, he cannot be held liable for an assessment, made on the subsequent insolvency of the bank, on the ground of estoppel, although through a failure of duty on the part of the bank and its officers no appraisal was made, and his name was retained on the stock-book, and because of such failure to act his certificate of stock had not been actually surrendered.

[Ed. Note.—For other cases, see *Banks and Banking*, Cent. Dig. § 915; Dec. Dig. § 248.*

Who liable as shareholders in national banks, see notes to *Beal v. Essex Savings Bank*, 15 C. C. A. 130; *Earle v. Carson*, 46 C. C. A. 503.]

*For other cases see same topic & § NUMBER in Dec. & Am. Digs. 1907 to date, & Rep'r Indexes

In Error to the Circuit Court of the United States for the District of Massachusetts.

Wilbur H. Powers, for plaintiff in error.
George L. Wilson, for defendant in error.

Before COLT, PUTNAM, and LOWELL, Circuit Judges.

LOWELL, Circuit Judge. The defendant in error, hereinafter called the plaintiff, is receiver of a national bank. The plaintiff in error, hereinafter called the defendant, formerly held 40 shares of stock in the bank. On September 5, 1904, the charter of the bank was extended, pursuant to Act July 12, 1882, c. 290, 22 Stat. 163 (U. S. Comp. St. 1901, p. 3458). The material part of section 5 of that act reads as follows:

"That when any national banking association has amended its articles of association as provided in this act, and the Comptroller has granted his certificate of approval, any shareholder not assenting to such amendment may give notice in writing to the directors, within thirty days from the date of the certificate of approval, of his desire to withdraw from said association, in which case he shall be entitled to receive from said banking association the value of the shares so held by him, to be ascertained by an appraisal made by a committee of three persons, one to be selected by such shareholder, one by the directors, and the third by the first two; and in case the value so fixed shall not be satisfactory to any such shareholder, he may appeal to the Comptroller of the Currency, who shall cause a reappraisal to be made, which shall be final and binding; and if said reappraisal shall exceed the value fixed by said committee, the bank shall pay the expenses of said reappraisal, and otherwise the appellant shall pay said expenses; and the value so ascertained and determined shall be deemed to be a debt due, and be forthwith paid, to said shareholder from said bank; and the shares so surrendered and appraised shall, after due notice, be sold at public sale, within thirty days after the final appraisal provided in this section."

Within the time limited by statute, the defendant gave the required notice in writing. Thereafter he appointed Dresser as his member of the appraisal committee, and the bank appointed Hinckley as its member.

The defendant made all reasonable efforts in good faith to have the third member of the committee appointed without result. In September, 1905, he retained an attorney, who communicated with Hinckley, urging him to join in making the appointment. The effort failed. On January 1, 1905, the bank declared a dividend, and sent to the defendant a check for the amount thereof due on 40 shares. The defendant promptly returned the check, declaring that he was not a stockholder. Other dividends were declared to the defendant by the bank on July 1, 1905, and January 1 and July 1, 1906. None of these three dividends were sent to or received by the defendant. On the bank's stock ledger the defendant was credited throughout with 40 shares. The bank never refused the defendant or withheld from him any of the rights and privileges of a stockholder; but the defendant never used or asserted any of these rights or privileges after September 5, 1904. The stock certificates were in the defendant's possession at the time of trial. The plaintiff was duly appointed receiver of the bank on August 16, 1906. The Comptroller of the Currency duly ordered an as-

assessment of 100 per cent., which the receiver seeks to collect from the defendant in this action.

By the terms of the statute, the defendant ceased to be a stockholder of the bank on giving his notice of withdrawal September 5, 1904. The purpose of the statute is to permit any stockholder under the circumstances stated to withdraw at once from the bank and so to terminate his liability. Congress did not intend that this liability should continue throughout the time taken to appraise the value of the defendant's shares. The defendant ceased to be a stockholder upon his giving the required notice.

But a person who is not a stockholder may yet be liable as a stockholder to the creditors of a corporation, if he has placed his name upon the books of the corporation as a stockholder, or, in some cases, if he has permitted his name to remain upon its books after he has ceased to be a stockholder. In such case the stockholder is held liable by estoppel. *Nat. Bank v. Case*, 99 U. S. 628, 25 L. Ed. 448. The creditors are deemed to rely upon the statements contained in the corporation's books. In the case at bar, a necessary element of the estoppel is wholly wanting. The defendant did not place or cause to be placed his name upon the stock ledger after he had ceased to be a stockholder. He did not permit it to remain upon that book, and its retention was caused solely by a failure of duty on the part of the bank and its officers. *Whitney v. Butler*, 118 U. S. 655, 7 Sup. Ct. 61, 30 L. Ed. 266; *Earle v. Carson*, 188 U. S. 42, 23 Sup. Ct. 254, 47 L. Ed. 373. Under the circumstances, an offer to surrender the certificates would have been a vain formality. Even if it be admitted that the ingenuity of the plaintiff's counsel has now suggested some attempt at removal which the defendant omitted to make, and which might possibly have resulted in success, yet this suggestion falls far short of the evidence required to make out the defendant's estoppel. The defendant was not a stockholder in the bank at the time the receivership was instituted, nor was he at that time estopped from denying that he was a stockholder.

In *Apsey v. Whittimore*, 85 N. E. 91, where the facts were exactly similar, the Supreme Judicial Court of Massachusetts reached our result by a course of reasoning which may be somewhat different from ours, but is in no way inconsistent.

The judgment of the Circuit Court is reversed, the verdict is set aside, the case is remanded to that court for further proceedings consistent with our opinion passed down this day, and the plaintiff in error recovers his costs of appeal.

CAMPFIELD v. SAUER et al.

(Circuit Court of Appeals, Sixth Circuit. November 20, 1908.)

No. 1,800.

CONTRACTS (§ 10*)—VALIDITY—MUTUALITY.

A proposition to a contractor, having a contract for the construction of a specified building, to furnish him with all of the timber of a specified quality and dimension for that building, when accepted, constitutes a valid contract, binding the seller to furnish, and the contractor to buy thereunder, all of such timber required for the building, and not one to furnish merely such as the contractor may order, and therefore void for want of mutuality.

[Ed. Note.—For other cases, see Contracts, Cent. Dig. §§ 28, 32; Dec. Dig. § 10.*]

In Error to the Circuit Court of the United States for the Eastern District of Michigan.

This is an action for the price of lumber sold and delivered under a contract, and counterclaim for damages for breach of contract in not delivering lumber as demanded. Jury, and verdict for the plaintiff and against the defendant on its cross-action. Writ of error was sued out by the defendant below.

H. B. Graves, for plaintiff in error.

R. E. Bunker, for defendants in error.

Before LURTON, SEVERENS, and RICHARDS, Circuit Judges.

LURTON, Circuit Judge. The case turns upon the validity of the contract involved, which was in writing, and is here set out:

"Ann Arbor, Mich., July 8, 1905.

"Mr. E. M. Campfield, General Contractor, High School and Library, Ann Arbor, Michigan—Dear Sir: We will furnish you all the timber as below sizes and prices hereafter named and specified free on board cars Ann Arbor, Mich., Ann Arbor Ry. delivery, for the High School and Library Building. Quality to be as per specifications for said building, all as per sizes and specifications, which you are to furnish us. And will do all in our power to get a quick delivery, especially the first floor tier of floor joist. (The following prices are net.)"

Then follows a list of sizes and prices of Georgia yellow pine and hemlock, not necessary to be here set out. This proposal was signed by C. A. Sauer & Co., and accepted in writing by Campfield. There was evidence showing that three orders for lumber were sent by Campfield and accepted by Sauer & Co., and all or nearly all of the timber so ordered actually delivered. The suit of the plaintiff below was for a balance of the price for the lumber so ordered and delivered. There was evidence offered by the defendant below that other orders were subsequently sent, which plaintiffs declined to fill, as well as evidence tending to show the damages sustained by the defendant below by reason of this refusal to fill these orders, which the defendant claims constituted a breach of the contract. The counterclaim or cross-action of the defendant was for the damages so sustained. All of this evidence was rejected upon the ground of the nonmutuality

*For other cases see same topic & § NUMBER in Dec. & Am. Digs. 1907 to date, & Rep'r Indexes

of the contract as contained in the proposal and acceptance of July 8, 1905, as set out above. The case resolves itself into a simple question as to the validity of the agreement upon which the cross-action was brought.

For the plaintiff in error, Campfield, it was contended below that the contract was one by which Sauer & Co. were obligated to sell all of the timbers, of the character and sizes and at the prices specified in the agreement of July 8th, which should be needed for the carrying out of his contract for the construction of the Ann Arbor High School and Library Building, and that he was upon his part obligated to take from Sauer & Co. all such timbers at the prices named. For Sauer & Co. it was contended that the contract was to sell to Campfield such timbers of the quality and sizes specified, at the prices specified in the agreement, as Campfield should choose to order for the High School and Library referred to, and that the agreement was unilateral, and therefore void, because Campfield was at liberty to order from them none or part or all such timbers, as he saw fit. This was the view accepted by the Circuit Judge, and all of the errors assigned are based upon rulings made upon the ground that the contract was invalid because nonmutual.

We find ourselves unable to agree with this interpretation of the contract. The proposal of Sauer & Co. shows that it was made to Campfield as a contractor for the Ann Arbor High School and Library and that it was a proposition to furnish him with all of the timbers, of the sizes and quality indicated by appended list, at the prices therein specified, which should be needed by Campfield in carrying out his contract. So far as the surroundings of the parties were disclosed by other evidence, it was inferable that Sauer & Co. had had access to the specifications of Campfield's contract, for Campfield says that the list of dimensions of timbers which is embodied in the contract of July 8th was brought to him by one of the Sauers, and the list in the proposal of that date made out from that list. The number of pieces of each size and quality needed by Campfield under his existing contract to construct the Ann Arbor High School and Library was the one thing needed to make the contract one for a definite quantity at definite prices. That could be made certain by the necessity of his building contract, including the specifications thereunder. The number of pieces of each size which should be needed was to be determined by the necessities of the building. This could not be well known, except as the work progressed. It therefore devolved upon Campfield to furnish Sauer & Co. from time to time lists of the quality and sizes needed to carry out the contract. This is the plain meaning of the clause in the proposal reading thus:

"Quality to be as per specifications for the said building all as per sizes and specifications, which you are to furnish."

The proposition was, therefore, not to sell at the price named such timber as Campfield might choose to order, but to "furnish you all the timber * * * for the High School and Library Building." When this was accepted by Campfield, he was obligated to take from Sauer & Co. all of the timber of the quality specified which he should need

to carry out the building contract referred to in the proposition at the prices proposed.

A proposition to a contractor, having a contract for constructing a specified building, to furnish him with all of the timber of a specified quality and dimension for that building, is a very different proposition from one to furnish him with all he may order. In the latter instance there would be a lack of mutuality, for there would be no obligation to order much or little, or any. It would be a mere option, and enforceable only to the extent of orders made and accepted. The case is ruled by the cases of Loudenback Fertilizer Company v. Tennessee Phosphate Company, 121 Fed. 298, 58 C. C. A. 220, 61 L. R. A. 402, and Lima Locomotive Works v. National Steel Company, 155 Fed. 77, 83 C. C. A. 593, 11 L. R. A. (N. S.) 713.

In Loudenback Fertilizer Company v. Tennessee Phosphate Company the contract enforced was one to sell to the fertilizer company "its entire consumption of phosphate rock" for a given term of years at a fixed price per ton. The buyer was engaged in making fertilizers requiring a large amount of such rock. This was held to be an agreement upon the one side to sell, and upon the other side to take, all of such rock as should be required by the necessities of an established business, with reference to which both contracted. We also held that it was a breach of agreement for the fertilizer company, upon an advance in phosphate rock, to buy an incomplete fertilizer made from phosphate rock as a substitute for the higher priced phosphate rock it had agreed to use in the normal conduct of its business.

In Lima Locomotive Works v. National Steel Company, cited above, the proposition accepted was to furnish "all of your requirements in steel castings for the remainder of the year. * * * You agree to furnish the tonnage you wish to order during the following month. We agree to fill your orders as specified to the amount of this tonnage and to make such deliveries as you require." The buyers were conducting an established manufacturing business, which required a large amount of castings. The contract was held to be valid, as one by which the one party was obligated to sell and the other to buy all such castings as should be required in the conduct of its business. The words "tonnage you wish to order" and "such deliveries as you may require" were held to have reference to the requirement of an established business for the "following month" and the delivery of the tonnage thus estimated. In the later case we referred to and approved the language of the court in the Loudenback Case cited above:

"A contract to buy all that one shall require for one's own use in a particular manufacturing business is a very different thing from the promise to buy all that one may desire, or all that one may order. The promise to take all that one can consume would be broken by buying from another, and it is this obligation to take the entire supply of an established business which saves the mutual character of the promise."

The errors assigned which relate to the interpretation of the contract and the evidence excluded because of an erroneous construction are sustained.

Judgment reversed, and a new trial awarded.

WEST HARTLEPOOL STEAM NAVIGATION CO., Limited, v. VIRGINIA-CAROLINA CHEMICAL CO.

(Circuit Court of Appeals, Fifth Circuit. November 10, 1908.)

No. 1,745.

SHIPPING (§ 173*)—CHARTER PARTY—DEMURRAGE.

Under a charter party which placed the duty of discharging and delivering the cargo alongside upon the owners, neither the charterer nor cargo can be held liable for demurrage because of delay in discharging beyond the stipulated lay days, without proof that it was through the fault of one or the other.

[Ed. Note.—For other cases, see Shipping, Cent. Dig. § 570; Dec. Dig. § 173.*

Demurrage, see notes to *Harrison v. Smith*, 14 C. C. A. 657; *Randall v. Sprague*, 21 C. C. A. 337; *Hagerman v. Norton*, 46 C. C. A. 4.]

Appeal from the District Court of the United States for the Southern District of Georgia.

For opinion below, see 151 Fed. 886.

William R. Leaken, for appellant.

Walter G. Charlton, W. W. Osborne, and A. A. Lawrence, for appellee.

Before PARDEE and SHELBY, Circuit Judges, and BURNS, District Judge.

PER CURIAM. The basis of libellant's claim is the charter party entered into on the 18th day of April, 1906, between the West Hartlepool Steam Navigation Company, Limited, as agents for owners of the good ship *Boltonhall*, with the Hamburg-Amerikanische Packetfahrt-Aktien-Gesellschaft, as charterers and freighters, by which it was provided, among other things, as follows:

"The cargo to be loaded as fast as steamer can take over out of lighters. Charterers bind themselves to have always sufficient cargo alongside to employ two or three steam winches. * * * Steamer is bound to work with all steam winches, if required. * * * Such days where the lighters are prevented by ice to come alongside the steamer not to count as lay-days. The steamer to be discharged at port of discharge at not less than an average of 300 tons per weather working day. If detained longer, demurrage to be paid 4 pence British sterling per ton gross register for every day so detained. The cargo to be brought to and taken alongside the steamer at charterers' risk and expense. The steamer to work at night, if required by charterers or consignees."

Under these provisions the duty of discharging cargo and delivering the same alongside was upon the ship and owners, and the charterers or cargo could only be liable for demurrage thereunder if the time of discharging was delayed through the fault of either beyond the number of lay days for discharging as provided in the contract. There is no evidence in the record showing that the delay in discharging beyond the lay days agreed upon was in any wise the fault of either the charterers or cargo.

The decree of the District Court, dismissing the libel, was correct, and it is therefore affirmed.

*For other cases see same topic & § NUMBER in Dec. & Am. Digs. 1907 to date, & Rep'r Indexes

McEWEN v. TOTTEN.

(Circuit Court of Appeals, Fifth Circuit. November 10, 1908.)

No. 1,865.

BANKRUPTCY (§ 140*) — PROPERTY PASSING TO TRUSTEE — CONTRACT — SALE OR LEASE.

A corporation at the time of its bankruptcy had in its possession a steam shovel, which it had obtained under a written contract by which claimant, who was the owner, agreed to lease it to the bankrupt at a monthly rental for eight months, at the end of which time the bankrupt agreed to buy it at a stated price. When the time expired nothing was done, but the bankrupt continued to pay the rental, and claimant paid the taxes on the shovel for the next year. *Held*, that the contract was one of lease, and not of sale, and that claimant was entitled to reclaim the property from the bankrupt's trustee.

[Ed. Note.—For other cases, see Bankruptcy, Dec. Dig. § 140.*]

Petition for Revision of Proceedings of the District Court of the United States for the Northern District of Georgia, in Bankruptcy.

John T. Norris, for petitioner.

Watt H. Milner, for respondent.

Before PARDEE and SHELBY, Circuit Judges.

PER CURIAM. Prior to bankruptcy the Southern Iron Company came into possession of a certain steam shovel under the following agreement:

"Cincinnati, Ohio, April 20, 1896.

"Southern Iron Company, Cartersville, Ga.—Gentlemen: I hereby agree to rent to you Little Giant Steam Shovel No. 472, now en route to Cartersville, Ga., at \$100 per month, payable on the 1st day of each month. Such rental period to be for a period of eight months, beginning May 1, 1906, with the understanding that such shovel is to be kept in proper order and working condition, less fair wear and tear. It is agreed that on or before January 1, 1907, you are to purchase said shovel and pay therefor in cash the sum of \$2,100 plus the freight on the shovel from Menton, Pa., to Cartersville, Ga. It is understood and agreed that, in the event of the swinging engine breaking down and a new set of engines are required, I will furnish the new engines, one-half of the cost of which is to be refunded to me January 1, 1907.

"[Signed] W. H. D. Totten, Jr.,

"Southern Iron Company,
"By W. M. Kelly."

After the bankruptcy the trustee, although the shovel was not listed by him as property of the bankrupt, kept possession of the same, and W. H. D. Totten, Jr., intervened, claiming the shovel as owner. The referee reported in favor of the trustee, and on a petition for review the District Judge ruled as follows:

"The steam shovel was delivered by Totten to the Southern Iron Company, and was used by the company. On January 1, 1907, nothing appears to have been said between the parties as to the purchase and nothing occurred. The shovel continued in the possession of the Southern Iron Company, and they continued to pay the rent, \$100 per month, for several months. The intervenor paid the taxes on the shovel for the year 1907. I do not think the title passed from Totten to the Southern Iron Company by the execution of the agreement set out above. In my judgment this agreement, properly con-

*For other cases see same topic & § NUMBER in Dec. & Am. Digs. 1907 to date, & Rep'r Indexes

strued, means that the shovel was leased to the Southern Iron Company for eight months, namely, from May 1, 1906, to January 1, 1907; that the Southern Iron Company had the right on January 1, 1907, to purchase the shovel by paying \$2,100 cash for the same, plus the freight referred to in the agreement. This right it failed to exercise. The fact that the company continued to pay the rent of \$100 per month after January 1, 1907, and the further fact of the payment of the taxes by Totten, indicates to my mind beyond question that no title passed. This was the construction which the facts would indicate that the parties themselves placed on the agreement. If the evidence of the witnesses introduced can be properly considered, it would strengthen this view of the matter, as they all appear to agree that their understanding was that the shovel remained the property of Totten, the intervener. I am compelled, therefore, to disagree with the view taken by the referee, and an order may be entered that the shovel be returned by the trustee in bankruptcy to the intervener."

This is a petition to review the ruling of the District Judge, and the question in matter of law presented is whether or not the agreement in question was a contract of sale, which transferred title to the property. From our examination, in the light of the undisputed evidence as to the construction the parties themselves gave to the agreement, we are of opinion that the said agreement was not a contract of sale, which transferred title to the Southern Iron Company, and we fully concur in the reasoning and ruling of the judge a quo, and the petition for revision is therefore denied.

NAZIMA TRADING CO. et al. v. MARTIN et al.

(Circuit Court of Appeals, Ninth Circuit. October 29, 1908.)

No. 1,635.

BANKRUPTCY (§ 444*)—APPEALS—TIME FOR PERFECTING.

An appeal in bankruptcy will be dismissed where citation was not issued nor the assignment of errors filed until after a term of the Circuit Court of Appeals had intervened, and the transcript was not filed until after a second term had passed, and no showing was made in excuse of the delay.

[Ed. Note.—For other cases, see Bankruptcy, Cent. Dig. § 920; Dec. Dig. § 444.*

Appeal and review in bankruptcy cases, see note to *In re Eggert*, 43 C. C. A. 9.]

Appeal from the District Court of the United States for the Third Division of the Territory of Alaska.

Kerr & McCord, Sam B. Berry, and Nathan H. Frank, for appellants.

R. F. Lewis and Richard C. Harrison, for appellees.

Before GILBERT, ROSS, and MORROW, Circuit Judges.

GILBERT, Circuit Judge. On March 16, 1907, the appellants, the Nazima Trading Company and Herman Meyer, as creditors of the Chititu Development Company, bankrupt, filed in the court below their objections to the confirmation of a sale of the bankrupt's property which had been made on November 12, 1906, and their motion to set the sale aside. On the same day the court overruled the objections

*For other cases see same topic & § NUMBER in Dec. & Am. Digs. 1907 to date, & Rep.'s Indexes

and the motion, and made and entered an order confirming the sale. On May 1, 1907, the said appellants so named, together with Jacob Sutter, a creditor of the bankrupt, filed in the court below their petition to set aside the said sale so made and confirmed. On August 6, 1907, the petition was denied. On August 9, 1907, the appellants presented to the court below their petition for an appeal, both from the order confirming the sale and the order denying their petition, and on the same day the appeal was allowed. On February 25, 1908, the appellants filed their assignments of error and their bond on appeal, and caused citation to issue, which was served on March 4, 1908. On July 27, 1908, no transcript having been filed in this court, one of the appellees moved on that ground to dismiss the appeal. On August 18, 1908, and before the motion to dismiss could be heard, the appellants filed their transcript in this court and docketed the cause. Thereafter two of the appellees moved to dismiss the appeal on the ground, among other grounds, that the transcript had not been filed or the cause docketed within the time allowed by the rules of this court.

We think the motion should be allowed. No order was obtained extending the time to file the transcript in this court. It was not filed until nearly five months after the return day. Intervening the return day and the filing of the transcript was the May term of this court, at which the appeal should have been heard. No showing whatever has been made of accident or mistake, and no excuse of any kind is offered for the delay. It is within the sound discretion of the court, it is true, to relieve parties who have not complied with the rules; but that discretion should not be exercised in a case where there has been long delay and there is utter absence of excuse or extenuation. *Grigsby v. Purcell*, 99 U. S. 505, 25 L. Ed. 354. Especially should this be held where, as here, the case involves the settlement of an estate in bankruptcy affecting the interests of numerous parties.

There is in the record the further ground of dismissal that, although the appeal was allowed on August 9, 1907, citation was not issued and the assignment of errors was not filed until February 25, 1908, and that in the meantime the October term of this court was held and adjourned. In *Jacobs v. George*, 150 U. S. 415, 14 Sup. Ct. 159, 37 L. Ed. 1127, and in *Pender v. Brown et al.*, 120 Fed. 496, 56 C. C. A. 646, it was held that by the intervention of a term of the appellate court between the allowance of an appeal and the issuance of the citation, if citation is not waived, the appeal becomes inoperative.

The appeal is dismissed.

VARY et al. v. JACKSON.

(Circuit Court of Appeals, Fifth Circuit, November 10, 1908.)

No. 1,764.

BANKRUPTCY (§ 417*)—SETTING ASIDE DISCHARGE—SUFFICIENCY OF PETITION.

A petition is insufficient to authorize the reopening of bankruptcy proceedings seven years after the bankrupt's discharge on the ground of a fraudulent concealment of assets, where it is verified on information and belief only by an assignee of a debt, does not show what property was scheduled by the bankrupt or what representations were made by him, that any creditors were deceived, or when the alleged fraud was discovered.

[Ed. Note.—For other cases, see Bankruptcy, Dec. Dig. § 417.*]

Petition for Revision of Proceedings of the District Court of the United States for the Northern District of Alabama, in Bankruptcy.

J. A. W. Smith, for petitioners.

Lee Cowart, for respondent.

Before PARDEE and SHELBY, Circuit Judges, and BURNS, District Judge.

PARDEE, Circuit Judge. The petition presented to the District Court to reopen the proceedings in the bankruptcy of J. F. B. Jackson, and to permit petitioners to prove debts on the ground of fraudulent concealment of assets, was not sufficiently definite and specific to entitle the petitioners as matter of law to any relief. On March 28, 1899, Jackson was adjudicated a bankrupt, and on the 15th day of May, following, he obtained his discharge as a bankrupt. The petition was sworn to on the 18th day of September, 1907, filed before the referee September 24, 1907, and denied by the judge the 6th day of January, 1908. It was verified by the affidavit of John Vary, who is averred to be the assignee (but no date of assignment given) of a certain judgment recovered against Jackson by one Nannie Sue Alford on the 9th day of September, 1895, and who swore that the facts stated are true to the best of his knowledge, information, and belief. The other alleged creditors did not present any affidavits as to facts, except C. E. Elder, who swore that he was the assignee of one G. Belton Massey, who was the only creditor who proved his debt in Jackson's bankruptcy, and that his assignment was dated November 17, 1906, and said Elder further swore that he was willing for the proceedings to be reopened, etc.

The petition fails to specifically show what property was surrendered by the bankrupt or what representations were made in his schedules as to property surrendered by him. It further fails to show that any creditor, at the time of the bankruptcy or in the year within which debts could be proved under section 57 (n) of the bankrupt act (Act July 1, 1898, c. 541, 30 Stat. 560, 561 [U. S. Comp. St. 1901, p. 3444]), was in any wise deceived as to the facts of the case or by the representations in the schedules. It further fails to show exactly when the alleged fraud was discovered, or that it was discovered within one

*For other cases see same topic & § NUMBER in Dec. & Am. Digs. 1907 to date, & Rep'r Indexes

year prior to the filing of the petition. See *Bailey v. Glover*, 21 Wall. 342, 22 L. Ed. 636; *Pearsall v. Smith*, 149 U. S. 235, 236, 13 Sup. Ct. 833, 37 L. Ed. 713.

In regard to this matter the only allegation we find in the petition is:

"The bankrupt's discharge was granted before the facts herein set out were known to the creditors or brought to the attention of this court, because they have been recently discovered."

This is too general, even if the petition had been verified properly. The record does not show what reasons actuated the judge a quo in denying the petition, nor whether any requests for amendment were made at the time of the said denial. In passing upon the proceedings, we are controlled by the record. The question of amending or of allowing amendments should have been presented to the lower court.

The petition for revision is denied.

LOFLIN et al. v. AYRES et al.

(Circuit Court of Appeals, Eighth Circuit. November 2, 1908.)

No. 2,791.

APPEAL AND ERROR (§ 78*)—TRIAL—ORDER STRIKING CASE FROM DOCKET NOT REVIEWABLE BY WRIT OF ERROR BECAUSE NOT A FINAL DECISION.

An order striking a case from the docket is not reviewable by writ of error in the national courts because it is not a final decision. It leaves the case pending and susceptible of reinstatement and hearing or dismissal on motion or petition. A writ of error or appeal to review such an order must be dismissed for want of jurisdiction of this court.

[Ed. Note.—For other cases, see *Appeal and Error*, Cent. Dig. § 471; Dec. Dig. § 78.*

Finality of judgments and decrees for purposes of review, see notes to *Bush Electric Co. v. Electric Imp. Co. of San Jose*, 2 C. C. A. 379; *Central Trust Co. of New York v. Madden*, 17 C. C. A. 238; *Prescott & A. C. Ry. Co. v. Atchison, T. & S. F. R. Co.*, 28 C. C. A. 482.]

(Syllabus by the Court.)

In Error to the Circuit Court of the United States for the Eastern District of Arkansas.

R. G. Brown and H. B. Anderson, for plaintiffs in error.

J. T. Coston, for defendants in error.

Before SANBORN and VAN DEVANTER, Circuit Judges, and AMIDON, District Judge.

SANBORN, Circuit Judge. Plaintiffs below, Sallie J. Ayres and others, brought an action of ejectment against the Anderson-Tully Company, a corporation, and another, in the circuit court of Mississippi county, in the state of Arkansas, in January, 1907, and on February 5, 1907, indorsed upon their complaint a statement of their election to transfer the cause to the chancery court of that county, and the clerk of the court indorsed the transfer chosen. Thereafter, and in due time, the Anderson-Tully Company filed in the circuit court of Mis-

*For other cases see same topic & § NUMBER in Dec. & Am. Digs. 1907 to date, & Rep'r Indexes

Mississippi county the proper petition and bond, and took suitable proceedings to remove the case from that court to the Circuit Court of the United States of the Eastern District of Arkansas. The latter court, after the transcript had been filed, upon motion of the plaintiffs below, made an order that the action be stricken from its docket, upon the sole ground that it was not pending in the circuit court of Mississippi county when the petition for removal was filed, and the writ of error before us was sued out to review this order.

But the jurisdiction of this court upon a writ of error is limited to the review of a final decision of the court below. Act March 3, 1891, c. 517, § 6, 26 Stat. 828, Supp. Rev. St. p. 903 (U. S. Comp. St. 1901, p. 549). An order, judgment, or decree which leaves the rights of the parties affected by it undetermined and open to further litigation in the same suit is not a final decision. *Standley v. Roberts*, 59 Fed. 836, 839, 8 C. C. A. 305, 308; *Collin County Nat. Bank v. Hughes*, 152 Fed. 414, 416, 81 C. C. A. 556, 558; *Stevens v. Nave-McCord Merc. Co.*, 150 Fed. 71, 73, 80 C. C. A. 25, 27; *Morrison v. Burnette*, 154 Fed. 617, 622, 83 C. C. A. 391, 396; *Chase v. Driver*, 92 Fed. 780, 784, 34 C. C. A. 668, 672.

An order which strikes a case from the docket of a court is not a final decision. It does not dismiss the action. It simply suspends proceedings in it until further steps are taken to secure a final disposition of it. The action is still pending, and may be reinstated upon the docket by the court upon motion or petition, and may then be decided upon its merits or dismissed for want of jurisdiction. *Welch v. Louis*, 31 Ill. 446, 455; *Tibbs v. Allen*, 29 Ill. 535, 548; *Hayden v. Huff*, 62 Neb. 375, 87 N. W. 184, 187. As the order challenged did not evidence a final decision of this case by the court below, it is not reviewable until a final decision has been rendered, and this writ of error is dismissed because this court is without jurisdiction to consider or decide the alleged errors which it was brought to correct.

INDUSTRIAL PRESS v. W. R. C. SMITH PUB. CO.

(Circuit Court of Appeals, Fifth Circuit. November 10, 1908.)

No. 1,870.

TRADE-MARKS AND TRADE-NAMES (§ 92*)—SUIT FOR UNFAIR COMPETITION—PLEADING—"CALCULATED TO DECEIVE."

A bill for unfair competition in trade by the use by defendant of a name for a periodical similar to one used by complainant must clearly allege that it was so used with intent to deceive the public or patrons, and an allegation that it was "calculated to deceive" is insufficient.

[Ed. Note.—For other cases, see *Trade-Marks and Trade-Names*, Dec. Dig. § 92.*

Unfair competition in use of trade-name, see notes to *Scheuer v. Muller*, 20 C. C. A. 165; *Lare v. Harper & Bros.*, 30 C. C. A. 376.]

Appeal from the Circuit Court of the United States for the Northern District of Georgia.

*For other cases see same topic & § NUMBER in Dec. & Am. Digs. 1907 to date, & Rep'r Indexes

The following is the opinion of the Circuit Court, by NEWMAN, District Judge:

The complaint does not, in my judgment, make by its bill, or by the trademark exhibited, a case of technical trade-mark.

Complainant may have a case for unfair business competition. The only language in the bill on this subject, however, seems to be insufficient. It is clear that the name "Southern Machinery" used by the defendant company, in order to make a case, must have been used with intent to deceive the public and those who would be likely to patronize it. The only language in the bill tending in this direction is the following expression:

"And your orator complains that the use by the defendant of the title 'Southern Machinery' is calculated to deceive the public into the belief that the periodical so entitled 'Southern Machinery' is another special edition of your orator's periodical 'Machinery.'"

"Calculated to deceive" does not mean or include intent to deceive. There should be a clear averment that the name is used with intent to deceive in the respects claimed in the bill.

Complainant's counsel has requested permission, if the court should believe the language insufficient, to amend the bill in this respect. If the complainant shall, within 10 days, amend its bill so as to meet the objection stated, the demurrer will be overruled; otherwise the demurrer will be sustained.

Burton Smith, for appellant.

J. Carroll Payne and Winfield P. Jones, for appellee.

Before PARDEE and SHELBY, Circuit Judges, and BURNS, District Judge.

PER CURIAM. We concur in the reasoning and conclusion of the judge a quo, and therefore the decree of the Circuit Court is affirmed.

AJAX FORGE CO. v. MORDEN FROG & CROSSING WORKS.

(Circuit Court of Appeals, Seventh Circuit. October 6, 1908.)

No. 1,433.

1. PATENTS (§ 323*)—INFRINGEMENT—SWITCH-ROD.

The Elborg patent No. 640,456, for an adjustable switch-rod in which an eccentric is used as means for adjusting the length of the rod in a split switch, is not a pioneer patent, but the device shown differs from prior devices only in the specific locking means employed, and, in view of the narrow construction required by the prior art, the patent is not infringed by the device of the Lee and Moore patent No. 679,153.

[Ed. Note.—For other cases, see Patents, Dec. Dig. § 328.*]

2. APPEAL AND ERROR (§ 1054*)—REVIEW—HARMLESS ERROR.

The admission in evidence in a suit in equity of a paper purporting to be an opinion given by counsel for complainant expressing doubt as to the right of recovery, even if not properly admissible, is not ground for reversal of the decree on the merits.

[Ed. Note.—For other cases, see Appeal and Error, Cent. Dig. § 4185; Dec. Dig. § 1054.*]

Appeal from the Circuit Court of the United States for the Eastern Division of the Northern District of Illinois.

For opinion below, see 156 Fed. 591.

This appeal is from a decree on final hearing of a bill filed by the appellant for relief against alleged infringement of a patent, which dismisses the bill

*For other cases see same topic & § NUMBER in Dec. & Am. Digs. 1907 to date, & Rep'r Indexes

for want of equity. The patent (No. 640,456) is for an "adjustable switch-rod" for use in railroad "point rail or split switches," and describes the invention as relating "to that class of switch-rods that are designed for adjustably connecting the switch rails, so that the proper positions of the latter with reference to the permanent rails may be always assured, while at the same time provision is made for taking up wear between the parts and compensation for variations in the positions of the movable parts of the switch." It farther specifies that the switch-rods "are made in two or more parts joined through the medium of a block or plate to which one of the parts is eccentrically connected, the other of the parts being provided with an eye or socket, or equivalent bearing, in which the block or plate is fitted, so that it may be rotated for the purpose of adjusting the length of the rod."

The following Fig. 1 is exhibited in the patent as a sectional elevation of the switch-rod, and Fig. 2 as a horizontal section on line 2-2 of Fig. 1:

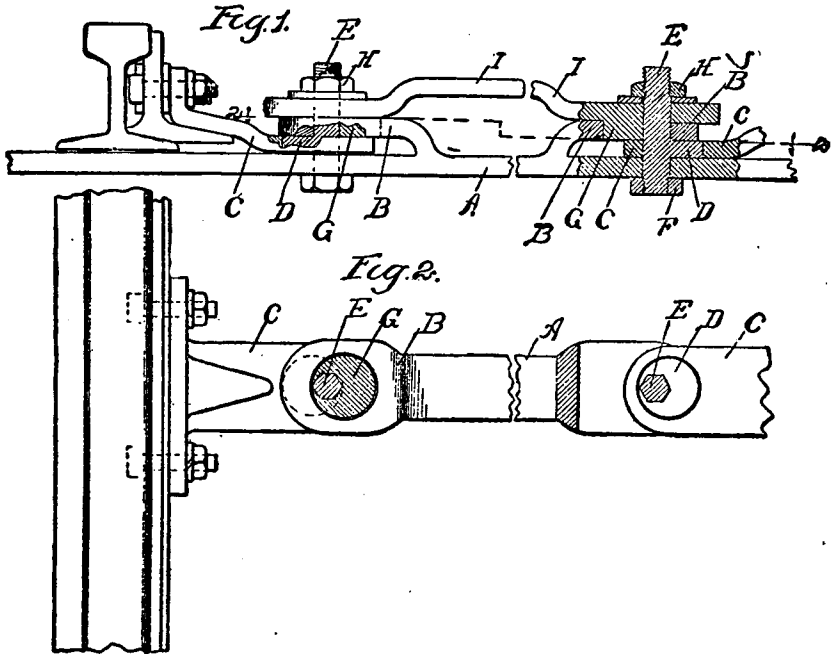

And the description and references in the specifications read:
 "A represents the switch-rod, which is connected to each of the switch rails by the means of them. The rod is provided with an overhanging ear B, extending parallel with it and providing jaws between which projects a portion of a chair C. The portion aforesaid of the chair is provided with a circular eye or socket, in which fits; so as to be capable of rotation, an eccentric D, formed with or non-rotatively attached to a shaft E. The portion of the rod A which forms one of the jaws has an opening through which the shaft E passes, and in which it has pivotal bearing, permitting its rotary movement, the lower end of the shaft being threaded for the reception of a nut F. The ear B, forming the other jaw, is also provided with an opening through which the shaft projects, the portion of the shaft occupying this opening being of non-circular shape, preferably polygonal. The opening in the ear B is for the purpose of providing a seat or bearing for a locking-block or plate G, which has means for non-rotatively engaging the shaft, the upper portion of the shaft being threaded for the reception of a nut, H, for holding the locking-block in place."

The opinion filed in the trial court by Judge Kohlsaet (as certified in the record) recites the claims in suit and the distinctions in means on which non-infringement is found, and reads as follows:

"This is a suit to restrain alleged infringement of claims 1, 3, and 6, of letters patent No. 640,456, for adjustable switch-rod, granted January 2, 1900, to Henry G. Elfborg. The claims in suit are as follows:

"(1) The combination with two parts to be joined, of an eccentric pivoted to one of them and fitting rotatively in an eye or socket in the other, a locking-block seated upon the part to which the eccentric is pivoted, means for non-rotatively connecting the eccentric and locking-block, and means for preventing the locking-block from moving about the pivotal axis of the eccentric, substantially as set forth.'

"(3) The combination with two parts to be joined, of an eccentric fitting rotatively in an eye or socket in one of the parts, a shaft carrying the eccentric and having pivotal bearing in the other of the parts, a locking-block having non-rotative engagement with the shaft, and means carried by the part in which the shaft has its pivotal bearing for preventing the locking-block from moving about the axis of the shaft, substantially as set forth.'

"(6) The combination with two parts to be joined, of an eccentric fitting rotatively in an eye or socket formed in one of them, a shaft carrying the eccentric and having pivotal bearing in the other of said parts, a locking-block having non-rotative engagement with the shaft, means carried by the part in which the shaft has its pivotal bearing for preventing the locking-block from moving about the axis of the shaft, and a handle carried by the locking-block for manipulating it, substantially as set forth.'

"A switch-rod is a member connecting and holding in alignment the movable opposite rails of a railroad switch, and the patent in suit relates to what is known, by reason of the pointed ends of its movable rails, as a 'point rail' or 'split switch.' Obviously, the simplest form of a switch-rod would be a plain rod or bar having holes for bolts or other means at each of its ends for fastening to the rails. This simple means of holding the rails in proper position is not, however, practicable for the reason that where the pointed rails contact with the continuous rails they gradually become worn and loose, thus necessitating frequent readjustment of the length of the switch-rod. Means for adjusting the rod to take up this wear has been the subject of many patents. Some have used the screw as a means of adjustment; others have used plates bolted to each end of the rod with a number of holes, each giving a new adjustment when used with the connecting bolt; while the later devices, of which the patent in suit is an example, use the eccentric as an adjusting means.

"The class of devices using the eccentric have these features in common: (1) Two principal parts of the rod to be joined; (2) a bolt, shaft, or pin passing through holes in each of the parts; (3) a disk fitted rotatively into one of the principal parts, through which passes, at some point other than its center, the axis of the coupling pin or bolt; (4) some means for locking this eccentric against rotation.

"The patents of this class differ from each other somewhat in the assembling of these parts, and this seems to be principally on account of their different means of locking the eccentric. The patent, therefore, cannot be called a pioneer patent. It follows closely the methods of the prior art in principle, differing only in the specific locking means employed.

"Defendant admits the manufacture and sale of two kinds of switch-rods which are charged to infringe the claims in suit: The first of these devices is substantially identical with that illustrated in Figs. 7, 8, and 9 of patent No. 679,153, granted to W. C. Lee and W. F. Moore on July 23, 1901, which patent is owned by defendant company. The second is a slight modification of the Lee & Moore patent No. 679,153. The difference between the two devices of defendants is admitted by both parties to be immaterial.

"The device of the patent in suit undoubtedly discloses peculiarities of construction not found in the prior art. Elfborg seems to have been the first who, by making the eccentric integral with the shaft, gave to that member the new functions of forming part of the means for adjusting the eccentric and for locking the eccentric when adjusted.

"Defendant's structure embodies these features of novelty, but goes a step further. While the shaft-head of complainant forms but a part of the means for locking the eccentric against rotation (the other part being a detachable locking-block), defendant's shaft-head is so made as to dispense entirely with the separate locking-block. Defendant has made in one part what complainant made in two, but in doing so has also changed the mode of operation. In adjusting complainant's device the nut on the shaft-head is removed, the locking-block lifted out, the shaft with its eccentric turned to the desired position, and the locking-block then replaced. In defendant's device the lower nut is removed (the upper one being integral with the shaft); the shaft must then be raised to admit of turning, and then lowered to lock the eccentric. While it may be, as seems to be the case, that Elfborg was the first to use the eccentric integral with the shaft, yet, considered separately, this was no part of his invention. What he did invent was a combination, and there is no rule of law prohibiting defendant's use of any elements of Elfborg's combination, provided it is used in a different combination.

"To find infringement, the court must find that the enlarged octagonal shaft-head of defendant's device is the equivalent of the 'locking-block' of complainant's claims, and that the integral connection between the shaft and its head is the equivalent of the 'means for non-rotatively connecting the eccentric and locking-block' of claim 1 and the 'non-rotative engagement with the shaft' of claims 3 and 6. Under the language of claim 6, this bolt-head must also be construed as 'a handle carried by the locking-block for manipulating it.' The defendant's bolt-head corresponds to the upper octagonal part of the shaft of complainant's patent. It is simply an enlargement of this part, and the 'locking-block' shown and described by complainant, and plainly meant by him when he uses the term, is a separate locking-block. There is no such part in the defendant's device. While the integral connection between the bolt-head and its shaft of defendant's structure might be construed to be equivalent to 'means for non-rotatively connecting the eccentric and locking-block,' this could not be done without manifest abuse of the language used in claims 3 and 6, where 'non-rotative engagement with the shaft' is called for. Engagement with the shaft implies clearly the want of integrality. It would seem a forced construction to hold that the bolt-head of defendant's device is the 'handle' described and claimed by complainant. There is no such handle in defendant's device.

"Complainant contends that it does not involve invention to simply make the locking-block of its patent integral with the shaft, and complainant's expert has gone into this question fully in his testimony, and has offered in evidence an exhibit model showing the integral connection of a bolt-head made circular and locked by a narrow lateral projection which is adapted to fit into any one of a series of notches formed around the hole in which the bolt-head rests. Leaving out of consideration the handle, which is integrally connected with the bolt-head, this construction is substantially that of defendant. The mode of operation is that of defendant: The lower nut must be loosened and the whole shaft raised before it can be adjusted. This exhibit model seems to beg the question. If integral connection is made between complainant's removable locking-block and its octagonal shaft-head, without other change, the device becomes inoperative and incapable of adjustment.

"Keeping in view the state of the prior art, and giving to the claims as broad a construction as the terms used will reasonably warrant, it does not appear that defendant has infringed, and the bill will therefore be dismissed for want of equity."

Thomas F. Sheridan, George L. Wilkinson, and Walter A. Scott, for appellant.

Dwight B. Cheever, for appellee.

Before GROSSCUP, BAKER, and SEAMAN, Circuit Judges.

PER CURIAM. The decree which is brought from this appeal is affirmed on the foregoing opinion of the trial court. Error is assigned for the conclusions there stated, of noninfringement, want of equity

in the bill, and dismissal accordingly; and each assignment is met and satisfactorily answered, as we believe, by the opinion so filed.

Complaint is further made, in the argument on behalf of the appellant, of error in receiving in evidence a paper purporting to be an opinion given by counsel for appellant (complainant) to such appellant, prior to filing the bill, expressing doubt of the infringement averred in the bill, which paper was brought out in cross-examination of the patentee, and so introduced on the part of the appellee, under a general objection that it was "not competent or pertinent to the issues," and was "merely a copy," not an original paper. The objection urged upon this appeal is that such opinion "was a privileged communication" between counsel and client, and that error appears in the ultimate refusal of the trial court, on appellant's motion, to exclude it on that ground. On the assumption, however, that the paper referred to was inadmissible upon one or the other ground, error is not assigned thereupon, as required by rule 11 (150 Fed. xxvii, 79 C. C. A. xxvii), nor can its inception disturb the decree upon the merits of the controversy.

The decree of the Circuit Court is affirmed.

CURTIS v. HUMPHREY.

(Circuit Court of Appeals, Seventh Circuit. October 6, 1908.)

No. 1,476.

PATENTS (§ 328*)—INFRINGEMENT—AUTOMATIC EGG-BOILER.

The Curtis patent No. 557,192 for a device for regulating treatment of substances chronometrically, applied principally to an automatic egg-boiler, while not a pioneer patent, discloses a patentable advance on the prior art and is valid. Claims 1 and 4 also *held* infringed.

[Ed. Note.—For other cases, see Patents, Dec. Dig. § 328.*]

Appeal from the Circuit Court of the United States for the Eastern Division of the Northern District of Illinois.

For opinion below, see 159 Fed. 169.

Paul Synnesvedt and James C. Bradley, for appellant.

Edward E. Longan, for appellee.

Before GROSSCUP, BAKER, and SEAMAN, Circuit Judges.

BAKER, Circuit Judge. Appellant's bill was dismissed for want of equity on the ground that his patent was not infringed by appellee's device. The suit was based on claims 1 and 4 of patent No. 557,192, issued to appellant on March 31, 1896, for a "device for regulating treatment of substances chronometrically." These claims are as follows:

"(1) In an apparatus for regulating chronometrically the treatment of substances, the combination of an attachment or holder for an object to be moved or withdrawn; a moving or withdrawing device; a chronometrically-operated detent; and means for engaging the detent with the withdrawing de-

*For other cases see same topic & § NUMBER in Dec. & Am. Digs. 1907 to date, & Rep'r Indexes

vice during a given period of its movement and releasing the same at the termination of such period; substantially as set forth."

"(4) The combination of a cord or chain suspending at one end a substance to be treated, and at the other connected to a normally active retracting device, with a shaft in chronometric rotation, and means for engaging the cord or chain with the shaft during any desired number of increments of the shaft rotation and releasing it when said increments are completed, substantially as set forth."

So far as these claims are concerned, the machine that is set forth in the specification consists of a basket (in which eggs, for example, may be submerged in a vessel containing boiling water), a chain that extends from the basket up over a pulley and down to a weighted ratchet bar, a ratchet disk in engagement with the ratchet bar, and a shaft which through intermediate gearing connects the ratchet disk to the escapement of a clock. The operation is this: The ratchet bar is set so that a greater or less proportion of its length (depending on the number of minutes the eggs are to be boiled) will have to pass the ratchet disk; the weighted bar causes the shaft to rotate; but the speed of rotation that would be due to the gravity-pull of the weighted bar is restrained and regulated by the escapement of the clock, so that the shaft is "in chronometric rotation" and the ratchet disk becomes "a chronometrically-operated detent"; and finally, when the disk releases the bar, the weight of the latter exerts a sudden pull on the chain and lifts the egg-container out of the boiling water.

Nothing in the prior art throws any doubt upon the patentable novelty of the above-described combination. The elements were old, and some of them had been combined for the same or analogous purposes. For example, in O'Brien's automatic egg-boiler (patent No. 284,051, August 28, 1883), a clock or timing mechanism pulls a trigger and releases a spring which pushes the egg-container up out of the water like a jack-in-the-box. Here is a combination of a "holder for an object to be moved or withdrawn, a moving or withdrawing device, and a chronometrically-operated detent." But no means is used or suggested "for engaging the detent with the withdrawing device during a given period of its (the latter's) movement and releasing the same at the termination of such period." And so with the Weissenborn patent No. 125,362, April 2, 1872, for raising lead pencils "from the bath of varnishing or coloring material, after having been dipped therein, at degrees of velocity corresponding with the nature and consistency of the said varnishing or coloring material and the thickness of the coat that is desired to be left thereon." Though the pencils are raised by a weight whose velocity of descent is regulated by an adjustable escapement, there is no way shown or hinted at for a time-measuring engagement and then a disengagement between the weight and the escapement, because the connection between the Weissenborn weight and escapement is continuous and permanent. The other references discussed by experts and by counsel (Gribben, No. 160,092, February 23, 1875; McGlynn, No. 375,497, December 27, 1887; Reithoffer, No. 403,446, May 14, 1889; Carbonnier, French patent, No. 8,692, February 8, 1837) also fail, in our judgment, to anticipate either in structure or creative thought the distinguishing feature of appellant's device as above described, namely, the twofold use of the weighted

ratchet bar, first, to act with the ratchet disk and the escapement as a measurer of the time during which the receptacle at the other end of the chain is to be allowed at rest, and, second, on being released from the ratchet disk, to act as the motor for the instant raising of the receptacle.

Now while appellant was not a pioneer in devising apparatus of this class, he is nevertheless entitled to a protection as wide as his invention. Appellee's device produces the same result by the same method of operation; and indeed no distinguishment is attempted except in two particulars. Appellant's patent covers more than the device as hereinabove described. The apparatus of claims 1 and 4 includes but one receptacle. Other claims provide means for operating a plurality of receptacles in connection with a single shaft and a single escapement. For this purpose appellant uses a certain braking mechanism to offset the action of the additional weighted ratchet bars as they come into play against the single escapement. When appellee desires to use a plurality of receptacles, he employs a like number of independent escapements. So he avoids the use of the braking mechanism. But this is wholly immaterial, because claims 1 and 4 do not embrace that feature of the patent. The other ground of distinction is that appellee does not have an independent clock. But, as hereinbefore stated, the "chronometric rotation" of appellant's shaft, so far as claims 1 and 4 are concerned, is obtained by restraining the gravity-pull of the ratchet bar by means of the shaft's geared connection with the escapement of the clock. For egg-boiling purposes time is measured by the operative length of the ratchet bar; and the hands and face and all the parts that would not affect the working of the escapement could be dispensed with. And that is just what appellee has done. But the substitution of a simple escapement for an entire clock not only fails to avoid the terms of claims 1 and 4, but clearly conforms to the express teaching of the patent. "It will readily be perceived that the overweight W, when engaged with the shaft B by means of its rack-bar h, becomes a motor for causing its rotation." "A clock C of ordinary construction is utilized as a regulating device for permitting a constant and chronometric rotation of the shaft B; but any form of motor capable of chronometric regulation or a simple escapement or other device permitting a time-regulated rotation of the shaft B may be employed in lieu of the clock C."

The decree is reversed, with the direction to enter a decree in appellant's favor for an injunction and an accounting.

EXPANDED METAL CO. v. GENERAL FIREPROOFING CO.

(Circuit Court of Appeals, Sixth Circuit. October 16, 1908.)

No. 1,783.

PATENTS (§ 328*) — PROCESS — DESCRIPTION OF MEANS—PROCESS OF EXPANDING SHEET METAL.

The Golding patent No. 527,242, for a method of making expanded sheet metal by slitting and stretching the sheet at the same time, is not invalid for insufficiency of description of the means by which the process may be

*For other cases see same topic & § NUMBER in Dec. & Am. Digs. 1907 to date, & Rep'r Indexes

practiced, nor because for the function only of a machine, but covers a new, useful, and patentable improvement in the art of expanding sheet metal, and is valid. Also *held* infringed.

[Ed. Note.—For other cases, see Patents, Dec. Dig. § 328.*]

Appeal from the Circuit Court of the United States for the Northern District of Ohio.

For opinion below, see 157 Fed. 564.

Ernest H. Hunter, for appellant.

G. H. Christy and Thomas W. Bakewell (E. H. Fairbanks, of counsel), for appellee.

Before LURTON, SEVERENS, and RICHARDS, Circuit Judges.

SEVERENS, Circuit Judge. This is a suit brought by the owner of letters patent No. 527,242, granted October 9, 1894, to John F. Golding, for a "Method of Making Expanded Sheet Metal," complaining of the infringement thereof by the defendant. In the court below the patent was held to be invalid upon the grounds stated by the Circuit Court of Appeals for the Third Circuit in its opinion in the case of Bradford v. Expanded Metal Company, the complainant here, reported in 146 Fed. 984, 77 C. C. A. 230.

On this appeal much reliance is placed by the appellee upon the decision in that case, and rightly so, for this court would be strongly inclined to follow a decision of that learned court, if made of the same questions and upon the same record as presented in the case before us. The question of the validity of the patent is the same; but we have no means of knowing what evidence was adduced in the case in the Third Circuit, and so are unable to determine to what extent, if at all, our duty to follow that court should constrain us. At all events, our impressions upon the questions involved are so strong that we feel compelled to express an independent judgment.

The art of expanding sheet metal had made considerable progress at the date of Golding's invention; and the product had been used for various purposes, such as latticework, trellises, screens, fencing, lath, and the re-enforcement of concrete structures. In general, it may be said it consisted of slitting sheet metal into narrow strands by making more or less short, parallel slits of equal length along the length of the sheet alternately; that is, in such way as that each alternate line of slits should equally overlap the ends of the adjacent slits in the first line of slits, and so on until the sheet was slitted. The sheet was then stretched laterally, the result being that the slitted strands and the uncut portions between them formed diamond-shaped meshes of nearly equal size and shape, but not of the desired uniformity, owing, doubtless, in large measure, to the variations in the thickness and texture of the sheet of metal. The sheet was shortened somewhat, but made much wider. This method had been improved upon, and notably by an invention of Golding and Durkee, patented by letters No. 320,242, dated June 16, 1885. We shall not stop to enter into a further description of other earlier methods, which were the subjects of patents in this and other countries, for the reason that it sufficiently appears that the Golding and Durkee invention just mentioned was the most advanced and

*For other cases see same topic & § NUMBER in Dec. & Am. Digs. 1907 to date, & Rep'r Indexes

had proved the most successful at the date of the invention which is the subject of the patent in suit. It seems desirable to describe the Golding and Durkee invention, patented in 1885, as we think it is the proper datum from which to reckon the novelty and utility of the subsequent invention of the Golding patent involved in the present suit. It consisted in—

“beginning at one side and corner and making an incision within the side of the metal, thus forming a strand which is simultaneously pressed away from the plane of the metal in a direction at or near a right angle, the position the strand assumes depending upon the distance it is moved from the plane of the metal. *a'* in the drawing shows the first cut made. The next step in this process is to make additional incisions, as is shown at *b¹*, *b²*, and *b³* in the figure here attached, further within the plate of metal, and leaving uncut sections at the ends of the cuts, and, simultaneously with the cutting, the strands are pressed away from the plane of the metal at the angle and to the desired position, as above described. Thus each row of meshes is simultaneously cut and formed from a blank piece of metal without buckling or crimping the blank. In the act of cutting and forming the meshes, the finished article is contracted in a line with the cuts or incisions, and consequently it is shorter in this direction than the piece from which it was cut, but is greatly lengthened in a line at an angle to the plane of the original sheet plate or blank.”

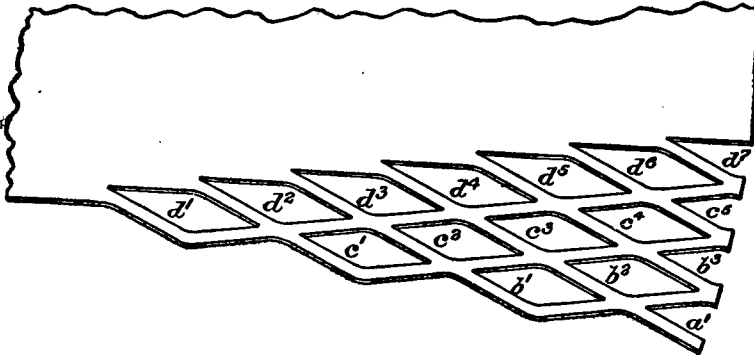

It is material to the purpose to observe (what will presently be seen) that by this method the strands are not strained by lengthening them, or, if so, not beyond what is incident to the slitting and crowding them out. On the contrary, the strands, when cut and crowded out, pull all their attachments near and far (or so far as the already cut parts of the blank extend), and is the cause of the shortening of the sheet; and, as the slitting and forming of the several meshes is going on at the same time, it is obvious that, with all the severed parts exposed to the strain of the operation, irregularities in the result from buckling and crinkling in the severed parts would probably occur. And the testimony shows that this was the result manifested by the process in operation. The sheet of metal was somewhat contorted and materially shortened.

The object of Golding's present invention was to so order the process of slitting and bending the strands to their place as to prevent the distortion of the sheet and preserve its length and the regularity of its

outline and of its meshes. To do this, he proposed to avail himself, as he says, of the capacity of the metal to lengthen and be bent under strain without materially impairing its strength. The method he proposes is this: He begins near one corner of the sheet and cuts a straight line of slits of equal length and distance apart near the edge of the sheet and along its length, and, simultaneously with the cutting of each slit, bending off and down the several strands into the form of one-half of a diamond-shaped mesh. He then repeats the same operation by slitting a line of slits parallel to the first, except that the middle of the length of each of his slits will be made opposite the space left uncut in the first operation, and, simultaneously with this second slitting, each severed strand is turned off and down to form the other half of the diamond-shaped mesh. By a continuation of this process the whole sheet is expanded without shortening and in regularly shaped meshes. The advantages of this process are obvious. They result from the circumstance that every time a slit is made and the strand bent to the required form the ends of the strand are supported and held in place by the whole of the uncut sheet. The cutting off and bending down of each strand is entirely independent of any other operation, and the maintenance of the length of the sheet is preserved by keeping the body of it entire while the strands are each being cut off and bent. It appears from the testimony of experts that the expansion of metal by stretching it does not, within moderate limits, weaken its tensile strength, though it has a tendency to make it more brittle, but not injuriously, if not carried too far. The utility of this method of expanding the metal is sufficiently proven.

Figure 1 of the drawings, reduced in size, illustrates the sheet partly expanded by the process or method above explained.

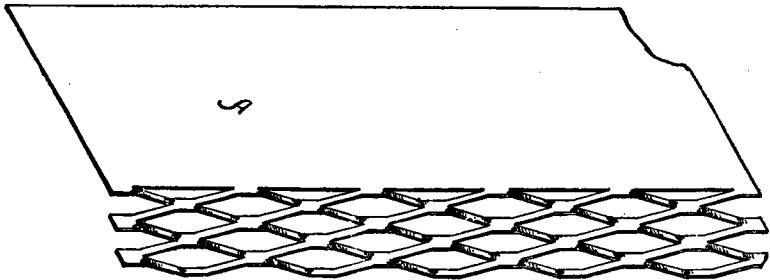

The claim reads as follows:

"I claim the herein described method of making open or reticulated metal work, which consists in simultaneously slitting and bending portions of a plate or sheet of metal in such manner as to stretch or elongate the bars connecting the slit portions and body of the sheet or plate, and then similarly slitting and bending in places alternate to the first mentioned portions, thus producing the finished expanded sheet metal of the same length as that of the original sheet or plate, substantially as described."

It seems even more simple than any method theretofore employed. It drew from the Circuit Court of Appeals for the Third Circuit the characterization of a "happy thought," and we think merited it. But that court felt constrained to reverse the decree of the lower court.

which sustained the patent, because the conception of the thought was unaccompanied by any sufficient description of the means by which it might be realized. We cannot agree to this, especially in the face of the testimony on that subject in the present record.

If the specifications for a process patent do not sufficiently indicate to those skilled in the art to which it relates some means or instrumentalities by which it may be practiced, and the contrivance or means for effecting it is beyond the skill of a trained mechanic, it might well be said that the inventor had not shown how to make his invention useful, and therefore had not entitled himself to a patent. It would seem probable that in view of the prior art a skilled artisan would be able himself to adjust the machinery already in use to execute the instructions contained in the specifications. But here the inventor has gone on to point out that the slitting and bending is to be done by a stationary cutter under the sheet, and upper cutters to co-operate in shearing the slit. These upper cutters are so constructed as to bend down the strand to the proper distance. It is not stated just what the form shall be, but only ordinary skill in mechanics would suggest that the outer side of the cutter might be beveled or a shoulder might be formed thereon to carry down the strand when severed. Mechanism for the shifting of the sheet and of the knives was already in use in machines for expanding metal, and, indeed, was common in the mechanical arts. Moreover, experts have here testified that these devices could be arranged by any skillful mechanic, and we have no reason to doubt it.

Nor can we agree to the suggestion that the patent was for the function only of a machine. No doubt the function or principle of a machine cannot be the subject of a patent. It is not a distinct entity, but a mere property of the machine, and inseparable from it, and is developed by its normal use. But Golding was not here seeking to patent a machine, or the operation of a machine. It was a matter of indifference to him by what particular means his method could be practiced, but only that certain things should be done in a certain order. The apparatus he suggests would not by any known method of use be of any value. True, he could slit and bend sheets and strands of metal with it. That was the function of it. But still, until and unless he invented a specific method of use, his apparatus was of no account. The material and the apparatus were mere *disjecta membra* until the light of more than the ordinary intelligence pointed the way to the subjection of the one to the operation of the other to a useful purpose. We think the invention may rightly and aptly be characterized as an improvement in the art of expanding sheet metal, and is within the letter and spirit of the statute. To hold otherwise would be to adopt a rule which would operate to exclude from the benefits of the law many valuable inventions of things new and useful, and this, not by resting upon any exception found in the statute, but upon an artificial graft of error alien to its spirit and purpose. Several of the decisions of the Supreme Court are cited by Mr. Justice Brown in *Risdon Locomotive Works v. Medart*, 158 U. S. 68, 15 Sup. Ct. 745, 39 L. Ed. 899, which illustrate the difference between the function, principle, or operation of a machine and the application of the function or principle

in a peculiar and as yet unthought-of way and the discovery of the new mode of application of the principle conduces to a new and useful result. The cases of *Mowry v. Whitney*, 14 Wall. 620, 20 L. Ed. 860, *Cochrane v. Deener*, 94 U. S. 780, 24 L. Ed. 139, and the *Telephone Cases*, 126 U. S. 1, 8 Sup. Ct. 778, 31 L. Ed. 863, are examples in point. And see *Carnegie Steel Co. v. Cambria Iron Co.*, 185 U. S. 403, 424-425, 22 Sup. Ct. 698, 46 L. Ed. 968, and 30 Cyc. 825. As we understand the case of *Risdon Locomotive Works v. Medart*, nothing is there decided which is in conflict with these views. Three patents were there under consideration. The first one considered was for a process in making belt pulleys. The other two were for belt pulleys. The last two were disposed of upon the ground that the pulleys were not essentially different from former constructions, but were better only in the respect that they were the product of superior workmanship; and that part of the case may, for present purposes, be laid aside. With regard to the patent for a process, the court took the view that the invention was only of the result of the mechanism therein described. The opinion of the court was thereupon summed up as follows:

"The result is a pulley more perfectly balanced, more faultless in shape, stronger and more durable, perhaps, than any other before produced; but this was not because the patentee had discovered anything new in the result produced, but because the mechanism was better adapted to produce that result than anything that had been before known. As pulleys of that description had been produced before, doubtless with greater care in the manufacture of them, a pulley as perfect as his might have been made. The operation or function of such machine, however, is not patentable as a process."

The vital differences between such an invention and this are that in this a new and different result is produced, a difference so great as to supplant all previous results; the mechanism by which it is produced is not new—that is, not patentably new; but the manner of its use is new, and the result is not produced simply by superior workmanship. That degree of workmanship which existed in the art had not been equal during the many years of the previous manufacture of expanded metal to the discovery of the method of producing it which Golding devised.

We are of opinion, therefore, that the patent should be sustained. The infringement of it is scarcely denied, and we have no doubt on that subject. The decree will be reversed, with costs, with directions to enter a decree for the complainant for an injunction, and for the profits and damages to be ascertained.

LOEW FILTER CO. et al. v. GERMAN-AMERICAN FILTER CO. OF NEW YORK.

(Circuit Court of Appeals, Sixth Circuit. October 16, 1908.)

No. 1,767.

1. TRIAL (§ 105*)—RECEPTION OF EVIDENCE—SECONDARY EVIDENCE—ADMISSION WITHOUT OBJECTION.

Secondary evidence is nevertheless evidence to be considered, if not reasonably objected to.

[Ed. Note.—For other cases, see Trial, Cent. Dig. § 265; Dec. Dig. § 105.*]

2. PATENTS (§ 69*)—ANTICIPATION—PRIOR PUBLICATION.

It is not competent to read into a publication relied on as an anticipation of a subsequent patent information which it does not give, nor by expert opinion explain an otherwise uninforming statement by evidence of some apparatus or article not itself competent as an anticipation.

[Ed. Note.—For other cases, see Patents, Cent. Dig. § 84; Dec. Dig. § 69.*]

3. PATENTS (§ 328*)—INFRINGEMENT—FILTERING PROCESS FOR BEER.

The Stockheim patent, No. 378,379, for a process of filtering beer, *held* not anticipated, valid, and infringed as to claims 1, 2, and 4. Claim 3 *held* void for anticipation by a prior publication.

[Ed. Note.—For other cases, see Patents, Dec. Dig. § 328.*]

Appeal from the Circuit Court of the United States for the Northern District of Ohio.

For opinion below, see 155 Fed. 124.

Wm. R. Baird, for appellants.

W. A. Jenner, for appellee.

Before LURTON, SEVERENS, and RICHARDS, Circuit Judges.

LURTON, Circuit Judge. This is a bill to restrain infringement of patent No. 378,379, granted February 21, 1888, to Simon and Frederick Uhlman, assignees of Heinrich Stockheim, inventor of a certain "new and useful filtering process for beer." The defenses are that the process had been anticipated and had not been infringed. The Circuit Court found the patent valid and infringed. In a number of prior litigations with other alleged infringers the validity of Stockheim's patent has been sustained against evidence of alleged anticipatory uses or publications. Uhlman et al. v. Bartholomae & Leicht Brewing Co. (C. C.) 41 Fed. 132; Uhlmann et al. v. Arnholdt et al. (C. C.) 53 Fed. 485; German-American Filter Co. v. Erdrich (C. C.) 98 Fed. 300.

After the fermentation of beer is completed, and the beer "finished," it is full of carbonic acid gas under pressure. It also contains yeast and other impurities, and is cloudy in appearance. The problem of the brewer at this stage of manufacture is to clarify his beer by freeing it from all yeast particles and other mechanical impurities and to pass it after such clarification into the receiving or shipping vessels without loss of carbonic acid gas. Turbidity of beer denotes the presence of yeasty particles which will soon set up a secondary fer-

*For other cases see same topic & § NUMBER in Dec. & Am. Digs. 1907 to date, & Rep'r Indexes

mentation, if not removed, and spoil it for use. It also detracts from the appearance of the beer and renders it unsalable. To retain in the beer the gas produced by fermentation is also essential; for, if there is material loss in filling the shipping kegs, the beer will be flat and undesirable. In passing the beer from the storage or chip cask into the shipping keg, more or less of the absorbed gas is freed by friction, and if it comes in contact with air or gas spaces in the course of such passage the escape of gas is serious. Such a condition produces foam at the keg, and interferes with filling, and causes loss. The great thing which the brewmaster sought was some economical process for filtering his beer while passing from the storage cask to the shipping keg without material loss of gas.

The earlier method of clarification was to place in the storage cask a sufficient quantity of isinglass, which dissolved and formed a thin film which slowly descended from the top of the beer in the cask to the bottom, usually covered with soaked beech chips, conveying with it the yeast germs and other impurities, which would, on settling, adhere to the chips at the bottom. The clear beer was then drawn off from above this layer of chips. This isinglass process was slow. It was expensive, and involved the loss of a considerable remnant of beer at the bottom of the chip cask. Under the old method the beer thus clarified was passed by a hose, usually of one inch diameter, attached to a faucet in the chip cask, which led to the racking-off bench; then it branched into two parts, each of one-half inch diameter. To the end of each branch a piece of flexible tubing, usually made of the gut of an animal, was attached. This gut was inserted into the bung of the shipping vessel nearly to the bottom, and the beer allowed to pour into the keg.

Stockheim was not the first who sought to substitute a mechanical filtration for this isinglass method. One of the first in the field was L. A. Enzinger, a citizen of Worms, in Germany. He secured a patent for a filter in both Germany and the United States; his American patent being dated November 12, 1878, issue No. 209,874. The defense of anticipation in the earlier cases involving Stockheim's invention, which have been cited above, as well as in the present case, largely hinges upon whether this Enzinger filter was intended or adapted to the process of Stockheim, and whether it had been successfully operated according to his method prior to his discovery and the grant of his process patent.

Stockheim, after giving some account of the earlier method of filtration by isinglass, and of the slowness and expense of such method, and of the failure of former mechanical methods of filtration because of the loss of gas in passing through the filter, proceeds to describe an apparatus by which he proposed to carry out a method of filtration which would be inexpensive and deliver the beer from the filter to the shipping keg without material foaming or loss of gas. His claims are four in number and are as follows:

1. The process of filtering beer, consisting in drawing the beer to be filtered from the cask under a pressure exceeding atmospheric pressure, conducting the same to and through a filtering apparatus in which that pressure is maintained during the filtering operation, keeping the filtering apparatus full of

beer, collecting and carrying off any air entering the filter along with the beer and gas separating from the beer during the filtering operation, and discharging the filtered beer from the filter under pressure, substantially as hereinbefore set forth.

2. The described process of filtering and keeping beer, which consists in forcing the beer under a pressure exceeding atmospheric pressure from the store cask through a filtering apparatus and thence to the keg, keeping said apparatus full of beer during the operation, and collecting and carrying off from the beer during its passage from the store cask to the keg air that may be mingled with the beer and gas that may separate from the beer, substantially as and for the purposes hereinbefore set forth.

3. The process of filtering beer, consisting in drawing the beer from the cask under a pressure exceeding ordinary atmospheric pressure, forcing the beer under said pressure through a filter, maintaining that pressure in the filter during the filtering operation, and creating and maintaining a back pressure in the filter, so as to keep the filter full of beer, substantially as described.

4. The process of filtering beer, consisting in drawing the beer from the cask under a pressure exceeding ordinary atmospheric pressure, forcing the beer under said pressure through a filter, maintaining that pressure in the filter during the filtering operation, creating and maintaining a back pressure in the filter, so as to keep the filter full of beer and collecting and carrying off from the beer any gas separating from the beer on its way from the store cask to or through the filtering apparatus, substantially as described.

That his process was a great practical success the evidence makes plain. That it was adopted and used by a great proportion of the large breweries, and that it superseded in a large measure prior methods and apparatus, is established. The single question is whether, when he conceived his method, it had already been publicly used or described in publications open to the public, and therefore anticipated. We must bear in mind that the Enzinger patent of 1878 was for a filter, an apparatus, and is not for a process, and that while Stockheim, as the statute required, points out a form of apparatus adapted to carry out his process, his patent is for a process, and not for the apparatus. A process patent can only be anticipated by showing an earlier similar process. It is not enough to show that the Enzinger filter might have been operated according to the process of Stockheim, but that his process had been actually used in its practical operation, or that the character of the structure was such as to plainly indicate to one called upon to operate it that its intended mode of operation was similar to that now claimed by Stockheim. *Carnegie Steel Company v. Cambria Iron Company*, 185 U. S. 421-425, 22 Sup. Ct. 698, 46 L. Ed. 968.

This Enzinger filter came to be used in some breweries in connection with an apparatus, also devised by Enzinger and covered by a German patent of 1880, which he called an "isobarometric filling apparatus for liquids containing gas," by means of compressed air conveyed through a hose connected both with the chip cask and the receiving or shipping keg, thus providing a forward pressure on one side of the filter to keep absorbed gas from escaping there and a back pressure on the other side for the purpose of keeping gas from escaping from the filtered beer. The forward and back pressure being the same, any flow of beer through the filter was due to the hydrostatic pressure consequent upon placing the chip cask slightly above the shipping keg. It will be observed that this patent of 1880 did not provide

for any filtering of the beer to be racked off. Neither did his prior patent of 1878 provide for either forward or backward pressure in connection with his filter.

But in 1880 an article appeared in a German brewing paper, the *Bier Brauer*, which described a method of operating this isobarometric apparatus in which the writer proposed to interpose in the line of hose between the chip cask and the racking bench an Enzinger filter. In 1882 another article, by Conrad Zimmer, appeared in a brewers' journal published at Worms, which appellants contend points out a method of operating Enzinger's filter in combination with a forward and backward pressure, which is the process of Stockheim, and therefore an anticipation by a publication accessible to the general public. After commenting upon the slowness and extravagance of the old isinglass method of filtration and the great economy of mechanical filtration, Zimmer proceeds to say of the Enzinger apparatus, evidently including his equal pressure apparatus with his filter, that "it ought to be received by the brewers as a certain means for clarifying turbid beer." He then proceeds to state "how the filter should be put up and used in practice." The parts of this article which are of importance in dealing with it as an anticipation are as follows:

"The foaming caused by the filter when filtering the beer into kegs is due either to the fact that most brewers do not use the somewhat inconvenient racking apparatus, or do not follow the directions given by the inventor. The filter is constructed according to settled fundamental principles: for instance, when racking off with the filter certain laws have to be regarded, and these the brewer must obey. In order to prevent the escaping of carbonic acid gas, back pressure must be applied, which is brought about through the isobarometric apparatus. If the work with the apparatus is too inconvenient, one needs only to raise his old racking apparatus so high that between the keg to be filled and the tap hole of the storage cask there is a difference of at least four meters. This difference in height can be increased to from six to seven meters without causing any trouble or making the pressure in the storage cask too high, as this pressure can be regulated from the air chamber through a safety blow-off on such chamber. Besides this, a cooling apparatus can be placed between the storage cask and the filter, so that the beer is cooled off with ice or a cooling mixture to 0 deg. R., or even lower, whereby the carbonic acid gas is completely retained, and the gluten is perfectly separated. Aside from the cooling last mentioned, the carbonic acid is, so to say, by the back pressure pressed into the beer, and no escaping of carbonic acid gas is to be feared. But in this connection it is to be remarked that no air should be allowed to pass into the filter, and, as is well known, a special contrivance is provided to prevent this. If there is the proper back pressure, and there is no air in the apparatus, the beer reaches the shipping vessel without a trace of foam. The escape of carbonic acid gas can only occur through the admission of atmospheric air, and the shipping vessel, as soon as it is filled, should be securely sealed."

The third claim of Stockheim consists of the following steps: First, "drawing the beer from the cask under a pressure exceeding ordinary atmospheric pressure"; second, "forcing the beer under said pressure through a filter"; third, "maintaining that pressure in the filter during the filtering operation"; and, fourth, "creating and maintaining a back pressure in the filter, so as to keep the filter full of beer." That the first three steps are anticipated by Zimmer is evident. The fourth step furnishes the controversy. The appellees say that Zimmer does not require that the filter shall be kept full of beer, and that this

condition is the key of Stockheim's process. Was this step taught or realized by the Zimmer article? True, Zimmer does not say in so many words that back pressure is to be maintained "so as to keep the filter full of beer." Neither does Stockheim in this claim make it a condition, in so many words, that air or gas originally in the filtering apparatus, or which enters or is disengaged during the operation, shall be vented. He does not deal with either air or free gas in the filter at all, except as the venting and exclusion of air or gas is implied by the fact that the filter is full of beer, meaning, of course, beer free from foam. But a similar implication must apply to Zimmer's method; for he, in express terms, makes the absence of air in the filter a condition upon which, in connection with "the proper back pressure," will secure beer free from foam at the receiving keg. Beer free from foam at the keg after filtration implies that the filter has been kept free from air, for otherwise it would not be free from foam. The one statement, to say the least, is the equivalent of the other; the advantage being with Stockheim, who does not leave to implication so necessary a step as the exclusion of air or free gas. Counsel speak of "air or gas spaces" as if vacuums. The distinction is not tangible. If there is an implied absence of air or gas, there is an implied absence of "spaces" which might be filled with air or gas. If, therefore, Stockheim's third claim is a practical process and a valid claim, without requiring definitely the collection and venting of air or gas in the filter when the operation begins, or which enters or is liberated during the operation, it was anticipated by Zimmer and is void.

The other claims of the Stockheim process include, in addition to the steps of the third claim, the collecting and carrying off from the beer of air in the filter and gas which may separate from the beer during the operation. His specifications and drawings show an apparatus adapted to vent air and gas, thus providing a venting arrangement which prevents such air or gas from being forced through the filtering material and out with the filtered beer at the keg.

We are not satisfied that the Enzinger apparatus was designed or adapted to carry out Stockheim's process, or ever so practically used. For the filtration of aerated waters he did provide a conduit by which disengaged gas on one side of his filter might be carried over to the other for reabsorption by the water as it came in on the inlet side. The try cocks referred to were evidently never designed, adapted, or used to vent collected air or gas. Enzinger in his later patent of 1888, being patent No. 393,633, concedes the necessity for more adequate means than he had theretofore employed for allowing the air to escape contained in the apparatus and the aptness of the filter sheets to be torn by forcing air or gas through them. The objection that the later patent is not in evidence comes too late. Prof. Chandler was examined about this patent, and sets out in his answer those parts of the specification of his 1888 patent containing this admission. No objection was made below, and it is too late to object now that this was not the best evidence of the contents of the patent. Secondary evidence is nevertheless evidence if not seasonably objected to. *Schlemmer v. Buffalo, etc., Ry. Co.*, 205 U. S. 1, 27 Sup. Ct. 407, 51 L. Ed. 681.

There is evidence as to a prior use of Enzinger's filter at two small breweries and for a short time. The practice seems to have been to expel the air in the filter by a preliminary run of either water or beer, forcing the air out through the filter paper before beginning the regular operation. To force either air or gas out of the filter by means of the pressure of water or beer behind it must have been injurious to the filtering material, paper in the instances relied upon, causing it to tear or channel, thus requiring frequent stoppage for repairs and permitting the passing of imperfectly filtered beer by reason of the injury to the filter paper. The evidence that this process was practical and successful is not of the character necessary to destroy this patent. Neither did this preliminary operation make any provision for getting rid of air which might subsequently enter or gas which might become disengaged during the later operation. Such air and such gas must be forced through the filter material and cause foam there and at the keg. The practice was not the process of Stockheim, who, as a condition in the first, second, and fourth claims, makes the "collection" and venting of air and gas a step in his method. To force it through the filter material and out with the filtered beer was not Stockheim's method.

Neither do we think the Zimmer article an anticipation of Stockheim's first, second, or fourth claim. While Zimmer points out that "no air should be allowed to pass into the filter," and that a delivery of foamless beer from the outlet side of the filter is dependent upon there being "no air in the apparatus" and a proper back pressure, yet he does not disclose how the admission of air is to be prevented, or how air which may be originally in the apparatus, or which may enter during the operation, or gas disengaged during the operation, is to be expelled without passing through the filter, to the injury of the filter material as well as to the beer. Zimmer seems to refer chiefly to preventing the admission of air to the apparatus, meaning, probably, during the operation of filtering. Touching such admissions, he refers to the use of a well-known "special contrivance provided to prevent this." What this contrivance was, or how it operated, he does not tell us, nor have we any means of knowing. Prof. Mabery, an expert for appellants, gives it as his opinion that by this reference to the exclusion of atmospheric air he meant the "luft sammler," or air collector, which is attached to the large filter used by the Hammels at Socorro and described in Michel Brewery Book. The contrivance referred to by Zimmer can only be shown by evidence that it was either in known common use or had been described by some publication of which the general public must take notice. The Zimmer publication must be given effect as an anticipation only to the extent that it actually gave to the public information of a process of filtration. It is not competent to read into such a publication information which it does not give, or by expert opinion explain an otherwise uninforming statement by evidence of some apparatus or article not itself competent as an anticipation. *Badische Anilin & Soda Fabrik v. Kalle & Co.*, 104 Fed. 802, 44 C. C. A. 201. The Michel Brewery Book referred to by Mabery is in evidence; but we think the date of its publication is not satisfactorily shown to have been before the actual date of Stockheim's invention—February, 1887.

Stockheim's process requires as a step the collecting and carrying off of air or disengaged gas. This is not taught by Zimmer, and the efforts made by such brewers as used the Enzinger filter according to Zimmer's instructions seem to have been such as we have mentioned before, namely, a preliminary run of beer to force the air in the apparatus through the filter and out at the racking bench as foam, filling only when the foam had ceased, or by a preliminary washing out with water, the water in turn being forced through by beer. In such case there was likely to be more or less injury to the filtering material, bad filtration, and much waste of time and beer. In none of the alleged prior uses, according to Zimmer, was there any method of collecting and venting air or disengaged gas which might enter the filter after such preliminary run.

An apparatus made and used by one King at a brewery has been relied upon as a prior use. This apparatus was relied upon in resisting the application for a preliminary injunction under the present bill. The opinion in the case was rendered by Mr. Justice (then Judge) Day. The opinion largely deals with this alleged prior use and is found in 103 Fed. 303. He thought the King apparatus a strainer, and so King called it, rather than a filter. He thought, although there was evidence that from time to time King increased his filtering material, that the evidence that his strainer anticipated or was adapted to carry out Stockheim's process was not so clear and cogent as required by the rule. There was an appeal to this court from the decree allowing an injunction *pendente lite*, but the order was affirmed. 107 Fed. 949, 47 C. C. A. 94. The evidence in this case, as now made up, leaves the practical character as well as the mode of King's operation in so much doubt that we find no reason for disturbing the view of the court below that prior use by King has not been made out.

The decree will be modified, so as to hold the third claim of Stockheim invalid; otherwise, the decree is affirmed.

The vertical air passage, E, of the filter made by the defendants, is adapted to and intended to permit the escape of air or gas, as well as water used in the preliminary operation of the Loew filter, and enables the defendants to collect and vent the air in the filter as well as the gas which may become discharged during the process. The device, therefore, infringes claims 1, 2, and 4.

The decree of the court below will be affirmed, except as to the third claim, which we think invalid. Costs of this appeal will be paid as follows: One-fourth by appellees, and remainder by appellants. Remanded for further proceedings not inconsistent with this opinion.

MARSHALL v. PETTINGELL-ANDREWS CO.

(Circuit Court of Appeals, First Circuit. September 25, 1908.)

No. 754.

1. PATENTS (§ 165*)—CONSTRUCTION OF CLAIMS.

Where one claim of a patent specifically names two elements, and another claim specifically names these two elements and in addition thereto a third element, it must be presumed that the patentee intended to limit the claims to the elements enumerated.

[Ed. Note.—For other cases, see Patents, Cent. Dig. § 241; Dec. Dig. § 165.*]

2. PATENTS (§ 328*)—INVENTION—SUBSTITUTION OF MATERIALS—INSULATING LININGS.

The Marshall patent No. 784,695, for an insulating lining for the metallic shell of an incandescent lamp socket consisting of a paper tube held in the metallic shell by its resiliency and yet easily removable, claims 5 and 9, which are broad claims, which do not include as an element a change in form from the linings of the prior art, are void as merely involving the substitution of paper as the insulating material for the fiber tubing previously used, the only advantage being its greater compressibility and resiliency, which were well-known qualities, and also because such broad claims are devoid of patentable novelty in view of the earlier Hart "Diamond H" switch cap, which had a paper lining similar in use, purpose, and function.

[Ed. Note.—For other cases, see Patents, Dec. Dig. § 328.*]

Appeal from the Circuit Court of the United States for the District of Massachusetts.

For opinion below, see 153 Fed. 579.

Sherman L. Whipple (Whipple, Sears & Ogden, on the brief), for appellant.

Hubert Howson (Howson & Howson, on the brief), for appellee.

Before COLT, PUTNAM, and LOWELL, Circuit Judges.

COLT, Circuit Judge. The Marshall patent, No. 784,695, issued March 14, 1905, is for an insulating lining for the outer metallic shell of an incandescent lamp socket. Prior insulating linings were made of hard fiber. The Marshall lining is made of paper.

The present bill is brought for infringement of claims 5 and 9 of the Marshall patent:

"(5) An insulating-lining consisting of a paper tube having its diameter reduced for a portion of its length, substantially as described."

"(9) The combination with a metallic shell, of an insulating-sleeve consisting of an elastic, compressible paper tube held in frictional engagement with the shell by its own resiliency."

The Circuit Court held these claims invalid and dismissed the bill. The ground of the decision was that the invention covered by these claims involved merely the substitution of one well-known insulating material for another well-known insulating material, with no change in result except of a minor character.

The Marshall invention will be better understood if we first con-

*For other cases see same topic & § NUMBER in Dec. & Am. Digs. 1907 to date, & Rep'r Indexes

sider the prior hard fiber lining shown in the Painter patent No. 718,378, and note the difference between the two linings.

The following drawing from the Painter patent illustrates the outer metallic shell of an incandescent lamp socket and the prior hard fiber lining:

In this cut the upper and lower figures show the two parts of the shell, and the middle figure the lining ready to be inserted in the shell. The shell is composed of a piece of tubular metal of different diameters—that is, about half the length of the tube is of a smaller diameter than the other half—and a shoulder is formed where the two parts of different diameter unite. The lining is made of hard fiber, and corresponds to the form of the shell; that is, it is a tube of different diameters, with a shoulder which unites the part of larger diameter with the part of smaller diameter.

The Painter lining was made by taking a piece of hard fiber tubing about the length of the shell, and of a proper diameter to fit within the larger end of the shell, and by the action of dies reducing or compressing the proper portion of the length of the tube to the smaller diameter required to enable it to fit within the smaller part of the shell.

The Painter lining met the substantial requirements of a satisfactory lining, and went into extensive commercial use. It was, however, open to some not very serious objections.

It is desirable that the lining should be retained in the shell when the parts of the shell are taken apart for wiring or other purposes, and at the same time should be so held in the shell that it may be quickly and readily removed for the purpose of refinishing the shell.

The defect in the hard fiber lining was that it was liable to drop out of the shell when it was desirable it should be retained, or was liable to be held too firmly in the shell when it was desirable to remove it.

Marshall conceived the idea of remedying this defect by making the lining of paper, and having a portion of the periphery of the lining of greater diameter than the part of the shell within which it is to fit, so that as the lining is inserted in the shell this portion will be compressed and by its elasticity will maintain a moderate pressure on the shell, sufficient to prevent the lining from falling out and at the same time permit of its ready removal. It will be observed that the Marshall conception involved both a change in material and a change in form.

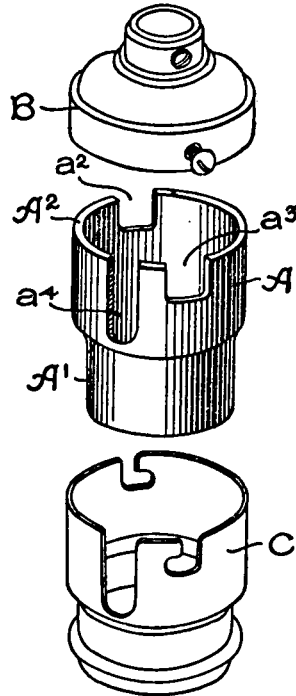

The method adopted by Marshall in making his lining was the same as the method shown in the Painter patent. Marshall took a piece of paper tubing about the length of the shell and of a proper diameter to fit within the larger end of the shell, and by the action of dies substantially the same as the Painter dies reduced a portion of the length of the tube to the smaller diameter required to enable it to fit within the smaller part of the shell; in other words, the dies were so shaped, just as in the Painter patent, as to give the lining when held by them the size and shape corresponding to the size and shape of the shell in which it is to be inserted. In submitting a paper tubing to this operation Marshall says he discovered that when the tube was released from the dies a portion of the reduced end at or near the shoulder would spring outward, thereby forming an elastic portion somewhat larger than the diameter of the part of the shell in which it was to fit.

A sectional view of this lining is illustrated in Fig. 4 of the Marshall patent:

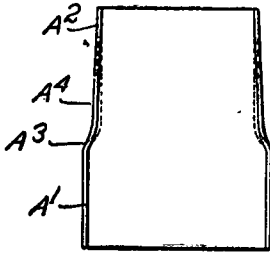

FIG. 4.

In this figure the dotted lines show the shape of the lining when held by the dies, and the solid lines show the expanded or holding portion of the lining, which is of slightly larger diameter than the portion of the shell into which it is to fit.

It thus appears that the Marshall lining differs from the Painter lining in two particulars: First, it is made of paper instead of hard fiber; and, second, it has a new structural feature consisting of a raised or enlarged portion of its periphery, which is of larger diameter than the part of the shell within which it is to fit. In other words, the Marshall lining differs from the Painter lining not only in the material of which it

is composed, but in its shape or form.

While this is the way Marshall says in his patent that he accomplishes the object of his invention, and while this is the form of lining specifically described in his patent and illustrated in the drawings, some of the claims of the patent cover a broader invention.

These claims do not limit the invention to a paper lining having the novel structural feature we have described, but they cover broadly a paper lining as distinguished from a hard fiber lining, or a paper lining which is held in frictional engagement with the shell by the resiliency of the paper.

The question of invention, therefore, arising under the claims of the Marshall patent, assumes a double aspect: First, was there invention in making a lining of paper with this new structural feature? And, second, was there invention in making a lining of paper with no change in its form? In the first case we have to support invention, not only the substitution of paper for hard fiber, but also a change in the form of the lining, while in the latter case we have only the substitution of paper for hard fiber.

The complainant in the present suit has seen fit to rely upon claims 5 and 9 of the Marshall patent, and the only question before us is whether these claims are void for want of invention.

To decide this question we must first determine the invention which is covered by these claims. Are the claims, or either of them, limited to the particular form of paper lining described in the patent, or do they cover broadly a lining made of paper instead of hard fiber?

The answer to this question requires a somewhat full consideration of the specification and claims of the Marshall patent.

The important parts of the specification may be stated as follows:

It is desirable that the insulating linings for incandescent lamp sockets should be retained in the shell when the parts are taken apart in wiring or for other purposes, and at the same time should be so held in the shell that they may be quickly and readily removed when desired, as for the purpose of refinishing the shell.

The linings which have gone into practical use have heretofore been made of insulating fiber tubing, and have been shaped to fit the shell as perfectly as possible. It has been found impracticable to make these linings fit the shell with just the requisite closeness to prevent the linings falling out, and still allow the ready insertion and removal of the linings. Moreover, if a lining under certain conditions properly fitted the shell, it would not do so under varying conditions as to moisture and temperature. The danger of these linings dropping out has been a recognized defect, and attempts to remedy this defect have not led to satisfying results.

The object of this invention is to provide a lining which will be retained in the shell at all times and under all circumstances, without danger of dropping out and without undue resistance to its removal.

"This I accomplish by forming an elastic insulating sleeve or lining having a portion of its periphery of larger diameter than the part of the shell within which it is to fit, so that as the lining is inserted in the shell this portion will be compressed and by its elasticity will maintain an effective holding pressure on the shell under all conditions. The lining may be made of any suitable insulating material having the requisite elasticity and adapted to be formed into the shape required to fit within the shells of the lamp sockets.

"I have discovered that elastic linings such as described" [that is, elastic linings having a portion of their periphery of larger diameter than the part of the shell within which it is to fit] "may be formed from paper tubing consisting of closely-wound layers of paper by the action of suitable-formed dies which draws down the tube for a portion of its length, and that the linings thus formed have the requisite elasticity and compressibility. I have also discovered that such paper linings will assume the proper shape when removed from the dies if the dies are shaped to give the lining when held by the dies a shape and size corresponding to the shape and size of the shell in which they are to be inserted. When the paper lining is released from the holding action of the dies, a portion of the reduced end will spring outward somewhat, thereby forming an elastic portion of a diameter somewhat larger than the diameter of the part of the shell in which it is to fit. When the lining is inserted in the shell, this elastic portion is compressed to the size originally given it by the dies, and by reason of its tendency to expand will hold the lining in place. By reason of my discovery of these peculiar characteristics of a paper tube when subjected to the action of the shaping-dies I am enabled to produce a lining having an elastic holding portion at materially less expense than the fiber linings have been produced, and thereby produce a more efficient and satisfactory lining and at the same time reduce the cost of manufacture."

The patent then proceeds to explain the method by which this paper lining is produced, referring to the accompanying drawings of the patent.

"In forming the elastic lining from a paper tube the tube A, which consists of closely-wound layers of paper closely compacted together, is subjected to the action of the dies B C. I have discovered that a thin paper tube of the requisite diameter for a socket-lining may be drawn down for a portion of its length by the action of dies similar to those used in drawing down fiber tubing if the female die is so shaped that the tube is confined throughout substantially its entire length during the action of the dies. I thus confine the tube by so forming the female die B that the part of larger diameter extends to the end of the tube A when the shoulder B' begins to act on the tube. With the dies thus shaped the tube will be drawn to a smaller diameter a portion of its length as the female die is forced into the position of Fig. 2. The lining thus formed has an end portion A' of larger diameter and a portion A² of smaller diameter, and is of a size and shape when held by the dies to fit within the metallic shell S. (Shown in Fig. 5.) When the female die is removed and the lining removed from the male die, the reduced portion A² springs outward at A⁴ near the shoulder A³, as shown in Figs. 3 and 4, the dotted lines showing the shape of the lining when held by the dies. This portion A⁴ forms an elastic and compressible holding portion, which is compressed as the lining is inserted into the shell, as shown in Fig. 5. This portion A⁴ tends to expand owing to the elasticity of lining, and thereby holds the lining in place while admitting of its ready removal and insertion when desired."

It may be observed with respect to this specification that the patentee says that he accomplishes the object of his invention "by forming an elastic insulating sleeve or lining having a portion of its periphery of larger diameter than the part of the shell within which it is to fit, so that as the lining is inserted in the shell this portion * * * will maintain an effective holding-pressure"; and that he then proceeds to state how he has discovered that such a lining may be made of paper, and to show the method by which this is accomplished.

It would seem, therefore, that the substantial invention, as it lay in the mind of the inventor, was a paper lining having a slightly enlarged or holding portion which would produce a gripping action sufficient to prevent the lining from falling out, and at the same time permit its ready removal.

We come now to the claims of the patent, and we will first consider some of the claims which are not in issue:

"(1) An insulating-lining consisting of a tube having end portions of different diameters and having an elastic and compressible portion of greater diameter than the part within which it is to fit, substantially as described.

"(2) An insulating-lining consisting of a tube having end portions of different diameters and having an elastic integral holding portion, substantially as described."

These claims cover a lining having its end portions of different diameters, and with an elastic holding portion of greater diameter than the part within which it is to fit.

"(3) An insulating-lining consisting of an elastic compressible tube one end of which is of smaller diameter than the other, substantially as described."

This claim covers a lining composed of a compressible tube in which one end of the tube is of smaller diameter than the other end. It is, in other words, the old hard fiber lining made of a compressible material.

"(4) An insulating-lining consisting of a tube having an elastic compressible holding portion of greater diameter than the part within which it is to fit, substantially as described."

This claim covers a lining having a compressible holding portion of greater diameter than the part within which it is to fit. This lining may not have its end portions of different diameters as in claims 1 and 2.

"(6) An insulating-lining consisting of a paper tube having its diameter reduced for a portion of its length and having a portion of greater diameter than the part within which it is to fit, substantially as described."

This claim covers a lining composed of paper in which the paper tube is reduced a portion of its length, and which also has a holding portion of greater diameter than the part of the shell within which it is to fit. The subject-matter of this claim is the particular form of paper lining specifically described in the specification and shown in the drawings.

We come now to the consideration of the two claims in issue:

"(5) An insulating-lining consisting of a paper tube having its diameter reduced for a portion of its length, substantially as described."

This claim covers a lining composed of paper in which the paper tube is reduced a portion of its length, substantially as described; that is, a paper tube having its diameter reduced a portion of its length by means of dies. Since in the Painter patent the diameter of the tube was reduced by means of dies substantially the same as the Marshall dies, the lining covered by this claim is the same as the Painter lining except that it is made of paper instead of hard fiber. We cannot construe the words "substantially as described" in this claim as including by implication another element, namely, a holding portion, or "a portion of greater diameter than the part within which it is to fit," for that would make the claim read identically the same as claim 6. Where one claim of a patent specifically names two elements, and another claim specifically names these two elements and in addition thereto a third element, it must be presumed that the patentee intended to limit the claims to the elements enumerated. This rule of construction is founded upon sound reasoning and common sense, and is now too well established to be questioned.

"(9) The combination with a metallic shell, of an insulating-sleeve consisting of an elastic, compressible paper tube held in frictional engagement with the shell by its own resiliency."

This claim covers a metallic shell in combination with a lining which consists of a compressible paper tube held in frictional engagement with the shell. The end portions of this lining need not be of different diameters, and there need be no enlarged or holding portion of greater diameter than the part within which it is to fit; in fact, there is no limitation in this claim as to the shape or form of the lining. It may, perhaps, be presumed that the whole of this lining would be made a little larger in diameter than the interior diameter of the shell, so as to be retained therein by the resiliency of the paper, and that to accomplish this the dies would be made a little larger than those shown in the patent. Marshall, however, nowhere states in his patent either

that the lining is to be made larger than the interior diameter of the shell or that the dies are to be made larger than those he describes.

From this analysis of the claims of the Marshall patent, it follows that claim 5 must be construed as covering broadly a paper lining of the same form as the prior hard fiber lining, and having its diameter reduced by the same method as that employed by Painter; and that claim 9 must be construed as covering broadly a paper lining with no limitations as to form but presumably made large enough to be held in frictional engagement with the shell. Stated in another way, the real invention contained in these claims is the substitution of paper for hard fiber in the lining of an incandescent lamp socket. That Marshall intended by these claims to cover broadly a lining made of paper instead of hard fiber is confirmed by the proceedings in the Patent Office as shown by the file-wrapper and contents. This construction of these claims has also been assumed by the witnesses in the case and by counsel in their oral arguments and printed briefs, and has likewise been adopted by the Circuit Court.

The substantial ground upon which the complainant rests the patentable novelty of claims 5 and 9 in issue is that Marshall made a discovery of the adaptability of paper to remedy the objections to the hard fiber lining. This alleged discovery was that paper possesses such properties of compressibility and resiliency that a paper lining made a little larger than the interior diameter of the shell may be pressed into the shell, with the result that it will be "retained in the shell at all times and under all conditions without danger of dropping and without offering undue resistance to its removal." These characteristics of paper, however, were well known. It may be said to be a matter of common knowledge that a paper stopper made a little larger than the neck of a bottle would be so held in the bottle that it would not fall out and at the same time be easily removable, and this in substance is all there is to this Marshall discovery. The recognition in the arts of these properties in paper and their utilization for the accomplishment of substantially the same results is exhibited in the old paper pill boxes shown in the Powers patent No. 156,591 and the Van Vechten patent No. 185,598.

Any possible claim, however, on the part of Marshall to this broad invention is fully met by the earlier paper lining of the Hart Diamond H. Switch Cap. These paper-lined switch caps and the paper-lined sockets of the Marshall patent in suit are alike in respect to their use and function. They are both electrical devices with metallic shells. Both these shells are lined with paper for the purpose of insulation. The linings in each case are held in place by the resiliency of the paper, and both are removable. The only difference is that the switch cap linings are crowded into the caps under great pressure and consequently are not so easily removable. It is manifest, however, that this comparatively unimportant difference simply in the degree of removability is insufficient to sustain Marshall's broad invention of a paper lining for an incandescent lamp socket.

It is true that the Marshall lining possesses the advantages of utility and cheapness, and that it has nearly supplanted in the market the hard fiber lining.

In cases where the question of patentability is involved in more or less doubt, these practical considerations are entitled to much weight, and they have frequently been held to turn the scale in favor of sustaining the patent. They cannot avail, however, in a case where the court is clearly satisfied that the broad conception underlying the patent did not involve inventive thought.

This case is limited to the consideration of the validity of claims 5 and 9 of the Marshall patent, and for the reasons given we must hold that these broad claims are void for want of invention in view of the prior art. The other claims of the patent are not before us, and we therefore express no opinion as to their validity. It may be observed, however, that the conclusion we have reached with respect to claims 5 and 9 is in no way inconsistent with the view that Marshall may be entitled to a patent for the particular way in which he says he solved the problem, as shown in the form of paper lining specifically described in the specification and illustrated in the drawings of his patent.

The decree of the Circuit Court is affirmed, and the appellee recovers its costs of appeal.

PUTNAM, Circuit Judge. I concur in the judgment, and also in the opinion of Judge COLT, subject to the following observation:

Judge COLT has carefully considered claims 5 and 9 from every point of view; but, as I am of the opinion that Marshall's invention necessarily involves a change in form as well as a change in material, I have not deemed it necessary to consider claims 5 and 9 except from the single point of view that those claims are void because they do not include the element of a change in form.

GOODYEAR TIRE & RUBBER CO. v. RUBBER TIRE WHEEL CO. et al.

(Circuit Court, S. D. Ohio, W. D. July 18, 1908.)

No. 6,280.

1. PATENTS (§ 327*)—PATENTS—SUIT FOR INFRINGEMENT—EFFECT OF DECREE FOR DEFENDANT.

A final decree in favor of the defendant in a patent infringement suit entitles him to continue to make and sell the alleged infringing article free from interference by the complainant by virtue of the patent, and a court of equity having jurisdiction of the parties may by a decree in personam enjoin the complainant from interfering with the defendant's business by bringing suits against his customers, based on the same patent, either in this or a foreign country.

[Ed. Note.—For other cases, see Patents, Dec. Dig. § 327.*]

2. PATENTS (§ 189*)—SCOPE OF GRANT—RIGHTS IN FOREIGN COUNTRY.

The monopoly of a patent does not extend beyond the jurisdiction of the government granting it, and whatever effect a patent granted by one country has in another depends upon the status given to it by the laws of the latter.

[Ed. Note.—For other cases, see Patents, Dec. Dig. § 189.*]

*For other cases see same topic & § NUMBER in Dec. & Am. Digs. 1907 to date, & Rep'r Indexes

3 EVIDENCE (§ 37*)—FOREIGN LAWS—LAWS OF CUBA UNDER MILITARY OCCUPATION.

Cuba, during the period of its military occupation by the United States, was not a part of the United States, but a foreign country, of whose laws an American court cannot take cognizance without plea and proof.

[Ed. Note.—For other cases, see Evidence, Cent. Dig. § 52; Dec. Dig. § 37.*]

4. PATENTS (§ 327*)—REGISTRATION IN CUBA—SUIT FOR INFRINGEMENT IN CUBA.

By virtue of the Platt amendment, imposed by the United States on the Constitution of Cuba, which provided that "all the acts of the United States in Cuba during its military occupancy thereof are ratified and validated, and all lawful rights acquired thereunder shall be maintained and protected," United States patents registered in Cuba during such occupancy under circular No. 12 and civil order No. 160 of the Division of Customs and Insular Affairs of the War Department, which provided for such registration and that the rights thereby acquired should be the same as given by the Spanish laws, acquired by such registry the status of a Cuban grant; and a suit for infringement of such a registered patent in Cuba is based on such grant, and not upon the United States patent, and is not barred by a decree between the parties in the United States holding the original patent invalid.

[Ed. Note.—For other cases, see Patents, Dec. Dig. § 327.*]

In Equity.

H. A. Toulmen, for complainant.

Staley & Bowman (Thomas W. Bakewell, of counsel), for defendants.

LURTON, Circuit Judge. In a suit in this court in which the Rubber Tire Wheel Company and the Consolidated Rubber Tire Company sought to enjoin the present complainant, the Goodyear Tire & Rubber Company, from making or selling rubber tires which infringed the Grant patent, No. 554,675, it was adjudged that the Grant patent was invalid and that the bill of complaint should be dismissed. The opinion of the Circuit Court of Appeals, directing the dismissal of the bill for the reason stated, was reported in 116 Fed. 363, 53 C. C. A. 583. Since that decree the Goodyear Company has continued to make rubber tires at its factory in Ohio under the protection of that decree and to sell them to all who would buy.

This bill alleges that since that decree and under its protection it has sold large quantities of these tires to the firm of Jose Alvarez & Co., doing business at Havana, in the Republic of Cuba. It alleges that the defendant companies, through their agent, one Manning, residing in Havana, have wrongfully interfered with this business by proceeding against the said Jose Alvarez & Co. in the courts of Cuba, to stop that firm from buying or selling the product of complainants, alleging such products to be an infringement of the said patent, and have actually secured process from the Cuban courts which operates as an injunction, and have caused a proceeding, both criminal and civil, to be instituted against Jose Alvarez for an unlawful sale of goods which infringe the patent rights of the said Rubber Tire and Consolidated Companies.

The object of the bill is to enjoin the defendants from any interference with the customers of complainant in the Republic of Cuba,

*For other cases see same topic & § NUMBER in Dec. & Am. Digs. 1907 to date, & Rep'r Indexes

by compelling them through a decree in personam to desist from interfering with the business of Jose Alvarez & Co., so far as that business is connected with the sale of rubber tires made by complainant under protection of the former decree between the parties now before the court. Upon the filing of the bill I made a restraining order, as prayed, to continue until notice could be given and an application be made and heard for an injunction pendente lite. Such notice has been given, and the case is now heard upon such motion; the application being based upon the bill and exhibits, supported by affidavits, and resisted by counter affidavits and exhibits. I shall content myself with a brief memorandum indicating the trend of my thought and my conclusion.

1. That the defendants in this suit are bound by the final judgment in the former suit is not controverted. One effect of that judgment is that, whether that decision was right or wrong, the Goodyear Company is entitled to make and sell rubber tires free from all interference from the defendant companies by virtue of the Grant patent. Another is that the defendants, as the defeated parties in that suit, may be enjoined or restrained from interfering with the business of the successful party by bringing suits based on the same patent against customers of the latter. *Kessler v. Eldred*, 206 U. S. 285, 27 Sup. Ct. 611, 51 L. Ed. 1065.

2. This court, as a court of equity having jurisdiction over the persons of the defendants, may control them, by decree in personam, from doing any act within or without the jurisdiction, at home or abroad, by bringing suit or otherwise, which shall be an interference with the right of the complainant to prosecute its business without interference with the defendants by virtue of the Grant patent. *Cole v. Cunningham*, 133 U. S. 107, 10 Sup. Ct. 269, 33 L. Ed. 538; *Penn v. Lord Baltimore*, 1 Vesey, Sr. 444; *Portarlington v. Selby*, 3 Mylne & K. 104, 106; *Story, Eq. Jur.* §§ 899, 900. That this power extends to the restraining of proceedings under the Grant patent in the courts of Cuba, whenever the court has jurisdiction of the persons of the parties, there is doubt. The cases cited above are clear. Mr. Justice Story, cited above, thus states the principles:

"But, although the courts of one country have no authority to stay proceedings in the courts of another, they have an undoubted authority to control all persons and things within their own territorial limits. When, therefore, both parties to a suit in a foreign country are resident within the territorial limits of another country, the courts of equity in the latter may act in personam upon those parties, and direct them, by injunction, to proceed no further in said suit. In such a case these courts act upon acknowledged principles of public law in regard to jurisdiction. They do not pretend to direct or control the foreign court; but, without regard to the situation of the subject-matter of the dispute, they consider the equities between the parties, and decree in personam according to those equities, and enforce obedience to their decrees by process in personam. * * * It is now held that, whenever the parties are resident within a country, the courts of that country have full authority to act upon them personally with respect to the subject of suits in a foreign country, as the ends of justice may require, and with that view to order them to take any steps and proceedings in any other court of justice, whether in the same country or in any foreign country." 133 U. S. 118, 119, 10 Sup. Ct. 273, 33 L. Ed. 538.

These propositions are incontrovertible, and, if it be true that the proceeding in Cuba is based upon the Grant patent, it is clear that an injunction should be allowed as prayed. But this is the point upon which the right must turn: Is the proceeding in Cuba of which complaint is made based upon the Grant patent? The defendants' counsel deny, and say that the Cuban proceedings are brought upon a Cuban grant founded upon the United States patent to Grant. I am quite clear that, if this is true, this court must stay its hand and permit the Cuban courts to determine whether the Cuban grant has or has not been infringed by the sale of tires made in this country under the protection of the decree referred to.

Boesch v. Graff, 133 U. S. 697, 10 Sup. Ct. 378, 33 L. Ed. 787, seems to be controlling. In that case it appeared that an invention was first patented in Germany and then in this country. In a suit upon the German patent in Germany it was held that a certain producer was not affected by the patent, because he had prepared to make the product before the inventor applied for his patent. The American suit was upon the American patent. The defense was that the infringing articles were made in Germany by the person held by the German courts not to be affected by the German patent. But it was held that goods purchased in a foreign country from a person authorized there to sell them cannot be imported into this country and sold here without a license from the American patentee. But it is to be noticed that the American patent held to be infringed by goods free of the German patent for the same invention was an independent patent granted by the United States for the invention previously patented in Germany. In respect to the basis for the infringement suit pending in Cuba the bill avers that it is—

"based upon letters patent to A. W. Grant, No. 554,675, granted February 18, 1896, as registered in Cuba, and which are the same letters patent that were declared null and void by the Circuit Court of Appeals for the Sixth Circuit in its decree aforesaid; said registration of said Grant patent in Cuba having been made by the Rubber Tire Wheel Company during the occupancy of the island of Cuba by the United States military forces, namely, by a conditional registration on the 3d day of July, 1900, numbered 589, and by a final registration on the 29th of March, 1901, numbered 1,223, pursuant to the provisions of a circular of April 11, 1899 (circular No. 12). Divisions of Commerce and Insular Affairs, War Department, Washington, D. C., promulgated and published by G. D. Meiklejohn, Acting Secretary of War."

May the owners of the Grant patent escape the consequences of the adjudication which protects the complainants from interference by virtue of the Grant patent, whether that business is carried on within the United States or in Cuba, the parties being within the jurisdiction, simply by "recording" that patent in Cuba? Manifestly not, unless such "registration" under the laws of Cuba is equivalent to a Cuban grant of a patent for an invention previously patented in the United States.

The monopoly of a patent does not extend beyond the jurisdiction of the government granting it. *Boesch v. Graff*, 133 U. S. 697, 10 Sup. Ct. 378, 33 L. Ed. 787; *Bullock Electric Company v. Westinghouse Electric Company*, 129 Fed. 105, 63 C. C. A. 607. Whatever effect a patent granted by one country has in another

depends upon the status given to it by the laws of the latter. Any proceeding in Cuba against one making or selling the invention described in the American patent to A. W. Grant must be based upon some status or protection extended to that invention by the law of or treaties with that country.

That Cuba, during the period of its military government by the United States, was no part of the United States, but a foreign country, within the principle above stated, is not debatable under the decided cases. *Neely v. Henkel*, 180 U. S. 109, 21 Sup. Ct. 308, 45 L. Ed. 457; *Pearcy v. Stranahan*, 205 U. S. 257, 27 Sup. Ct. 545, 51 L. Ed. 793; *United States v. Assia (C. C.)* 118 Fed. 915. For this reason this court cannot take cognizance of the law of Cuba without plea and proof. *Liverpool Steamship Company v. Phoenix Insurance Company*, 129 U. S. 397, 445, 9 Sup. Ct. 469, 32 L. Ed. 788. The burden of showing that under the law of that country protection had been extended to the Grant invention rests upon the defendants. Only by showing such a status can they escape the effect of the former adjudication between the same parties. In *Lloyd v. Guibert*, L. R. 1 Q. B. 115, 119, Mr. Justice Willes said:

"A party who relies upon a right or exemption by foreign law is bound to bring such law properly before the court and to establish it in proof. Otherwise the court, not being entitled to notice such law without judicial proof, must proceed according to the law of England."

This principle is approved and the case cited in *Liverpool Steamship Company v. Phoenix Insurance Co.*, cited above. The bill of complaint shows that the infringement proceeding pending in Cuba is based upon a Cuban "registration" of the Grant patent, authorized by an order of the military government of Cuba during the American occupation of that island. What was and is the legal effect of that "registration"? This is a question of Cuban law.

Cuba was not without a government and laws in the interval between the overthrow of the Spanish government and the institution of an independent Cuban government. The military government, which was substituted for the Spanish government, was the de facto government of Cuba while it lasted. Therefore rules of action, civil or criminal, prescribed by that government, constituted, so far as they went, the law of Cuba while that military government endured. Therefore I must concede to any order or decree of that government the same effect as if made by a civil government. To put it in another way: If the law of Spain, effective in her insular possessions, had provided that foreign patents might be "registered" in Cuba, the single question would be as to the legal effect upon such patent of such "registration." To the edict of the de facto government ad interim I think must be given all the consequences which would have followed from a similar law promulgated by the prior civil government. To discover the consequences of such "registration," we must not only examine the so-called "circular" under which the registration occurred, but also the prior system of protecting inventions under the Spanish law relating to Cuba.

The defendants, as before noticed, have neither pleaded nor answered. Neither have they filed a transcript of the record upon which they are proceeding against the complainant as an infringer. They did tender such transcript in Spanish, but, not being able or willing to have same translated in time for this hearing, they have notified me that they withdraw same. I do not, therefore, treat that transcript as before me, and am consequently deprived of such information as might be derived from knowing whether that proceeding on its face purports to be based upon a Cuban patent. The only evidence of any law of Cuba, whatever its source, is an exhibit filed by defendants of a printed book entitled "Legislacion Industrial." By an attested certificate of a notary public this book was issued by the authorization of the President of the Republic of Cuba, and contains "the patent and trade-mark laws, orders, decrees, etc., in force in Cuba, with their subsequent annulments and amendments." This book has not been objected to, and is therefore treated as proof of Cuban law relating to patent rights. Contained in that is the order of the Assistant Secretary of War of the United States of April 11, 1899, by virtue of which, as recited in the paragraph of the complainant's bill above set out, this Grant patent was recorded in Cuba. That order is as follows:

"In territory subject to military government by the military forces of the United States owners of patents, including design patents, which have been issued or which may hereafter be issued, and owners of trade-marks, prints and labels duly registered in the United States Patent Office under the laws of the United States relating to the grant of patents and to the registration of trade-marks, prints and labels, shall receive the protection accorded them in the United States under said laws; and an infringement of the right secured by lawful issue of a patent or by registration of a trade-mark, print or label shall subject the person or party guilty of such infringement to the liabilities created and imposed by the laws of the United States relating to said matters: Provided, that a duly certified copy of the patent or of the certificate of registration of the trade-mark, print or label, shall be filed in the office of the Governor General of the island wherein such protection is desired; and provided, further, that the rights of property in patents and trade-marks secured in the islands of Cuba, Porto Rico, the Philippines, and other ceded territory, to persons under the Spanish laws, shall be respected in said territory the same as if such laws were in full force and effect."

With respect to that order it should be observed that by its terms it was operative only in territory subject to military government by the military forces of the United States, and that it provides that patents so recorded shall receive "the protection accorded them in the United States under said laws," and that an infringer in Cuba under that order was subject only to "liabilities created and imposed by the laws of the United States relating to said matters." Treating this as Cuban law, it would seem to follow that, if the complainants were entitled to be free from interference by virtue of the Grant patent under the laws of the United States, they were equally free under this law of the military government. Under a later order, styled "Circular No. 21," of June 1, 1899, parties desiring "protection in territory under government of the military forces of the United States for patents, trade-marks, prints or labels, as provided in circular No. 12," were required to file certified

copies, etc., with the Governor General. A still later order by the military government of Cuba, styled "Civil Order No. 160," of June 13, 1901, provides as follows:

"(1) The rights of property in patents, copyrights, and trade-marks duly acquired in Cuba, the Isle of Pines, and the island of Guam pursuant to the provisions of Spanish law and existing in one or all of said islands on April 11, 1899, shall continue unimpaired for the period for which they were granted, and the owners thereof shall be protected and their rights therein maintained: Provided, that the original or a duly certified copy of the patent or of the certificate of registration of the trade-mark or copyright is filed in the office of the Governor of the island wherein such protection is desired.

"The certificates of registration of trade-marks issued prior to April 11, 1899, by a Spanish provincial registry or the national registry of Spain, at Madrid, or the international registry at the Bureau of the Union for the protection of Industrial Property, at Berne, Switzerland, shall receive such recognition and credence as were accorded them in said islands under Spanish sovereignty; and an original certificate or duly certified copy thereof shall be received and filed in the office of the Governor of the island for all purposes connected with this order without further or other certification.

"(2) The rights of property in patents, including design patents, granted by the United States, and trade-marks, prints and labels duly registered in the United States Patent Office, and in copyrights duly registered in the office of the Librarian of Congress, shall be maintained and protected by the government of civil affairs in the islands above named: Provided, that a duly certified copy of the patent or of the certificate of registration of the copyright, trade-mark, print or label is filed in the office of the Governor of the island wherein such protection is desired.

"(3) An infringement of the rights protected by compliance with the provisions of this order shall subject the person, firm, association or corporation guilty of such infringement to the civil and penal liabilities created and imposed by such of the laws of Spain relating to said matters as remain in force in said islands.

"(4) Such provisions of existing orders as are in conflict with this order are hereby revoked."

After the establishment of the independent government of Cuba, a decree was promulgated by the Department of Agriculture, Commerce, and Industries under date of June 21, 1902. That document is styled in the book of Cuban laws a "Decree of the Cuban Government on American Patents," and provides as follows:

"The military government of the United States having ended, by virtue of which, according to the express text thereof, circulars Nos. 12 and 21, of April 11 and June 1, 1899, respectively, of the Division of Customs and Insular Affairs of the War Department, Washington, relative to the registration of American brands and patents, are without value or effect, inasmuch as said circulars were issued for the territories subject to military government by the military forces of the United States, I have resolved that patents and brands of all kinds, prints, labels and trade-marks registered in the Patent Office of the United States, the deposit of which, for their protection in this island, is requested in the future, shall, from this day on, be registered in the department under my charge, if same is proper, through the medium of the same procedure followed for the registration of those of other countries and payment of \$35 currency for patents and \$12.50 currency for brands, prints, etc., or, that is, the same fees paid for all others, domestic and foreign, instead of \$1 currency, fixed by the said circular No. 21, with respect to those of the United States.

"This is published in Gaceta de la Habana for general information."

The same book of industrial laws shows that the basis law applicable to Cuba prior to the military government of 1898 was the Roy-

al Ordinance of June 20, 1833, which law, except as affected by later "laws" of the ad interim government or the laws of the present Republic of Cuba, is still the law of that country. Under that law a grant might be obtained, upon the filing of a memorial accompanied by a drawing or model and proper description of the invention, of "anything which is not practiced and used either in these dominions or in any foreign country." The grant is made upon a representation of novelty and usefulness, but without any examination into that question. The privilege, when granted, is required to be recorded, and is not to be deemed an indorsement in any form of the novelty or usefulness of the invention; that being under that law a matter for determination judicially when novelty or usefulness is denied.

In view of this right to obtain a privilege of monopoly upon a mere representation of novelty and usefulness, I reach the conclusion that the legal effect of the military order set out in circular No. 12, above quoted, as amended by civil order No. 160, was to place a "registered" American patent in the status of a Cuban grant of a monopoly for the same invention before the subject of the American patent. Although circular No. 12 only operated to secure to patents so registered that measure of protection accorded them by the laws of the United States, the effect of civil order No. 160 was to extend to such "registered" American patents the identical remedies imposed by the laws of Spain in force relating to such matters against those who infringe a Spanish Grant in force in Cuba. Neither do I think that the decree of June 21, 1902, had, or was intended to have, the effect of destroying rights theretofore secured by such registration under the edicts of the military government. Those orders had ceased to be operative only because conditions had changed. A similar method of registration, with like protection, is provided by this decree of the civil government. That rights lawfully acquired under the military government in force during American occupancy of the island should not be affected by the institution of the government of the Republic of Cuba was one of the objects of the Platt amendment imposed by the United States upon the Constitution of Cuba. Of this amendment I may take notice, because its acceptance was made a condition of withdrawal from the island by the United States. The fourth section of that amendment provides:

"That all the acts of the United States in Cuba during its military occupancy thereof are ratified and validated, and all lawful rights acquired thereunder shall be maintained and protected."

This constitutes part of the fundamental law of Cuba, and validates or ratifies the acts done under the direction or by authority of the military government, and guarantees the protection of the rights acquired by the "registration" of the Grant patent. The defendants having made out their right to proceed under the "registered" Grant patent as an independent monopoly protected by the law of Cuba, the case of the complainant fails. The subject-matter of the former suit in this case is not the same as the subject-matter of the pending Cuban suit. In the one case the American patent to Grant

was involved; in the other, a Cuban grant for the same invention.

An essential element of estoppel is lacking. The stay order must be dissolved, and an injunction pendente lite denied. It would seem that no other relief is possible, if an injunction is inadmissible, and that the bill is without equity. If complainant cannot, upon a final hearing, make a different showing of fact touching the Cuban law applicable, and desires an early appeal to the Circuit Court of Appeals, they may draw a decree dismissing the bill for want of equity. If, however, it prefers to go to a regular hearing upon the full evidence as to the fact of Cuban law, the decree will simply deny the injunction and discharge the restraining order.

LIBERTY v. CHAMPION-INTERNATIONAL CO.

(Circuit Court, D. Massachusetts. November 2, 1908.)

No. 333.

PATENTS (§ 328*)—INFRINGEMENT—PAPER-DRYING MACHINE.

The Liberty patent No. 629,696, for a lath-carrying device for paper-drying machines, claim 2, which specifies as an element of the combination "hoppers for feeding the said laths," must be read in the natural sense of its terms, and is limited to a machine employing a plurality of hoppers, and is not infringed by a machine having a single hopper.

[Ed. Note.—For other cases, see Patents, Dec. Dig. § 328.*]

In Equity. On final hearing.

William Quinby, for complainant.

Burdett, Wardwell & Snow, Burdett & Wardwell, and Alex. P. Browne, for defendant.

BROWN, District Judge. The bill charges infringement of letters patent No. 629,696, granted July 25, 1899, to Saul R. Liberty for an improvement in lath-carrying devices for paper-drying machines. The patentee says:

"My invention relates to improvements in machines for feeding laths for drying paper; and it consists in providing carrying-belts having projections for feeding the laths forward and two or more accumulating supports for feeding the laths to said carrying-belts. It also consists in providing a lath-carrying device with belts having feeding projections formed thereon, lath-accumulating hoppers for holding and feeding out the laths, and a smooth belt for assisting in accumulating the laths in one of the said hoppers. It also consists in certain other novel constructions, combinations and arrangements of parts, as will be hereinafter described and claimed."

The specification states also:

"Lath-carrying devices have been used heretofore which are adapted to feed laths forward for supporting paper which has been colored or provided with some ornamental configurations. Such machines, however, should be provided with means for feeding more than one style of lath to the paper, and should also be provided with means for accumulating the laths at different points for this purpose."

Drying machines for drying coated paper have been in use for many years. The green web of paper, in order that it may be dried, is hung

*For other cases see same topic & § NUMBER in Dec. & Am. Digs. 1907 to date, & Rep'r Indexes

on sticks or slats, which are supported by belts. The wet paper is hung in separate festoons, supported by the slats, and is moved slowly along through a hot room sufficient in length to harden and thoroughly dry the coating. The length of travel of the slats is a hundred or more feet. When the paper has dried it is rolled up, and the slats which have supported the successive festoons, having completed their travel, must be returned in some way to the other end of the drying machine to be used again. Automatic stick-returning mechanism has been in use for many years. It is shown in the patents to Waldron, No. 222,765 and No. 322,871, of 1885, and in the English patent to Jones of 1859. There is also testimony aside from the prior patents to the effect that the defendant's machines are of a type manufactured and put upon the market at least five years prior to the date of the patent in suit. The general combination of carrying belts to carry along the slats while they support the festoons of paper, of belts to return the slats so that they may begin a new travel, and belts for raising the slats so returned to the level required for carrying forward the festoons of paper, was old.

The principal question in this case is as to the construction which is to be placed upon claim 2, the only claim in suit.

"(2) In a lath-carrying device for paper-drying machines, the combination with belts having lugs for feeding paper-supporting slats or laths forward, hoppers for feeding the said laths, a guide interposed between two of the said belts for directing the slats from one to the other, and springs mounted in the said guides preventing the return of the slats and insuring the proper contact of the lugs of the belts with the slats or laths, substantially as described."

The claim uses the term "hoppers." The defendant uses only a single hopper, and his machine is of a construction which antedates the complainant's patent except in the single particular of a spring mounted in the guide between the belt which returns the slats to the front of the machine and the belt which lifts the slats from the front of the machine to the belt which carries them forward while they support the festoons of paper. The question whether claim 2 must be read as calling for two or more hoppers is not a verbal question, but a substantial question. If we read the claim literally, it presents the novelty of two or more hoppers for feeding the laths and of means for feeding more than one style of lath to the paper. The claim so read is not anticipated by the prior art, and is valid but not infringed, since the defendant has only a single hopper incapable of feeding more than one style of lath or of accumulating the laths at different points.

In order to make a device with a single hopper an infringement of claim 2, it would be necessary to disregard what seems to be the most important and characteristic feature of the patent in suit—the double feed. Assuming, however, that there may be a novel combination whether one or more hoppers are used, and that one hopper for feeding the laths is the equivalent of two, so far as the operation of transferring the slats from the lower belt to the lifting belt is concerned, we have to inquire specifically what advance over the prior art is shown by the claim thus construed. Over the prior patents shown in the record there is an advantage in the simpler way in which the slats

are lifted from the lower to the higher level. Both Waldron and Jones have somewhat complicated mechanism for effecting this transfer. The machine of the defendant, which upon the testimony must be regarded as in the prior art, shows a simplification of means for the transfer, and a simpler and less costly device for this purpose than is shown in the prior patents. The patent in suit refers to the feature of a curved guide, but this is of similar construction to that found in the defendant's device. The patent in suit also says:

"The transfer of the slats from the lower belt to the lifting belt also forms a novel feature of my invention, and produces a simpler and less costly way of accomplishing this result than has heretofore been in use."

This mode of transfer is substantially that of the defendant's device. Considering the prior art as consisting of the prior patents and of the defendant's machine having a curved guide and the same mode of transfer of slats from the lower belt to the lifting belt, the only feature of novelty contained in claim 2 is a spring mounted in the guide to prevent the return of the slats and to insure their proper engagement with the lugs of the belts. By a construction of claim 2 which disregards the double feed by two hoppers, we should be forced to consider whether Liberty by adding a spring detent to the defendant's machine had made a new invention. In view of the fact that it appears in testimony that a number of workmen had equipped the defendant's device with a spring detent from time to time, there is a very serious doubt whether this can be regarded as anything more than such an obvious improvement as would be made by the ordinary mechanic. While it is not impossible in construing combination claims to regard certain elements as of chief importance and as characterizing with their novelty the entire combination, so that great liberality will be exercised in applying the law of equivalents to other features of the combination, yet in view of the fact that without a spring the generic combination is old, of the emphasis placed upon the double hoppers and other specific devices, and the slight emphasis placed in the specification upon the feature of a spring, we think we should be reading the claim in a strained and unnatural way were we to say that it was for a combination characterized by the inventive novelty of a spring mounted in a guide. The only reference in the specification to the spring feature, the use of which is the sole ground for charging the defendant with infringement, is as follows:

"The guide g^1 may be provided with one or more springs, as g^3 , for causing the slats to be engaged more perfectly by the lugs of a belt, G , and thus insure their being fed forward at the proper time."

Nowhere is this use of a spring detent specifically referred to as one of the inventive, as distinguished from one of the ordinary mechanical, elements of the combination. The patentee describes as the inventive features two or more accumulating supports for the laths and the use of a smooth belt for accumulating the laths in one of the hoppers, and of means for feeding more than one style of lath; but beside the brief reference to the spring which we have quoted, the only other reference is in the following language:

"The transfer of the slats from the lower belt to the lifting belt also forms a novel feature of my invention, and produces a simpler and less costly way of accomplishing this result than has heretofore been in use."

The complainant dwells upon this with particular emphasis, but the exact meaning of the patentee is not clear. He refers to a simpler and less costly way than has heretofore been in use. If he makes a comparison with the devices of the Waldron patents and of the Jones patent, it is quite true that he shows a simpler and less costly way; but comparing the means of transfer with the defendant's it is not a simpler and less costly way than that used in the defendant's machine, which it is conceded is in this particular substantially like that of the complainant. The addition to the defendant's device of a spring detent is certainly not an advance in simplicity or less costly. Possibly it may be an advance in efficiency over the defendant's device, though upon the testimony in the record this is doubtful; but as it is not by a simpler or a less expensive means, it would seem that the patentee's reference to the mode of transfer must be simply to those features shared in common by the complainant's and the defendant's devices, and which are not new with the complainant. As to the importance of the spring detent, the testimony shows that this is not essential to the operativeness of the machine, that its use by the defendant was only occasional, and that the slight defect which led to the use by the workmen of a spring or gravity detent was a minor matter.

The burden is upon the complainant in this case to show that the word "hoppers" in the plural can be read in the singular without doing violence to the general meaning of the claim. To so read the claim we are obliged to hold as immaterial all of the specific features relating to the double feed which the patentee regarded as his chief invention. It would do violence to the specification if we should hold that the spring detent was referred to as a feature in itself sufficient to support claims. Assuming novelty in the use of a spring detent; in the claim this novelty is coupled with another novelty, that of two distinct feeds. It may well have been that the Patent Office considered that the accumulation of such specific features as to feed and as to improved engagement of the slats with the transfer belts was sufficient to support a claim for details in an art in which the generic combination was otherwise old. It should be remembered that the ground upon which the defendant is charged with infringement is a very narrow one. It is not contended that the defendant's machine is an infringement, except when it is used with a spring device or a pivoted dog whose sole function is to permit the stick or lath, as carried along by a tooth on the horizontal belt, to ride up on the guide sufficiently high to clear the lug on the belt and then to prevent the lath from slipping back until the lug on the inclined or transfer belt engages the lath to carry it up for delivery. To construe claim 2 so as to prevent the defendant from equipping an old machine with a familiar mechanical device like a spring or gravity detent seems unwarranted. If this case were to be tried upon a claim modified as the complainant seeks to modify it, by eliminating entirely the double feed, the issue would be whether it constituted invention to add to defendant's older commercial machine a spring detent, in view of the fact that several mechanics independ-

ently had done the same thing for the same purpose. Irrespective of the priority of this addition, the obvious character of this change as the application of a means familiar to ordinary mechanics would seem to be established by the testimony.

Reading the claim as containing a reference to the double hoppers, we are very sure of the invention to which it relates. Disregarding this feature, and reading the word "hoppers," in the singular, we are not only departing from the terms of the claim, but are probably eliminating the chief characteristic which the inventor had in mind when he made his claim. As we have said, the burden of proof is upon the complainant to justify the reading of the word "hoppers" in the singular. The only justification is in the assumption that the addition of a spring detent to the defendant's machine constituted a patentable invention. The grant of the patent is not even *prima facie* evidence in support of this contention. While the grant of the patent shows that a combination with two hoppers is *prima facie* patentable, it is not *prima facie* evidence that the addition of a spring detent to the defendant's device is patentable. I am of the opinion that claim 2 must be read as it stands, and that it calls for at least two hoppers. This is the natural meaning of the terms of the claim itself, and is the natural meaning of the claim in view of the specification.

On the other hand, the complainant's reading is a violation of the terms of the text, and also requires the elimination from the claim of a substantial physical element shown in all the drawings and performing a function additional to that of a single hopper. I am of the opinion that the complainant has failed to show the propriety of the construction for which he contends, and that the court is not required to accept his reading of the claim upon the principle of interpretation that construction should be that which will sustain rather than defeat the patent. The court is asked to substitute for the invention expressed by the terms of the claim, and *prima facie* valid, an invention not expressed by the claim, and of such doubtful novelty that it cannot be safely assumed that either the Patent Office or the patentee considered it as a sufficient basis for the grant of a patent.

I am of the opinion that the defendant is correct in its contention that the claim should be read in the natural sense of its terms, and is limited to a machine employing a plurality of hoppers, and that the defendant has not infringed, since it has used only a single hopper and not a double feed.

The bill will be dismissed.

In re GOLDICH.

(District Court, E. D. Pennsylvania. October 9, 1908.)

No. 2,625.

BANKRUPTCY (§ 414*)—DISCHARGE—FAILURE TO KEEP BOOKS.

Evidence held to sustain the finding of a referee that the failure of a bankrupt to keep such books of account as would disclose his financial condition was intentional, and with a purpose to conceal such condition, and that he was therefore not entitled to a discharge.

[Ed. Note.—For other cases, see Bankruptcy, Dec. Dig. § 414.*

What persons are subject to bankruptcy, see note to *Mattoon Nat. Bank v. First Nat. Bank*, 42 C. C. A. 4.]

In Bankruptcy. On certificate of referee concerning objections to bankrupt's discharge.

Furth and Singer, for bankrupt.

Clinton O. Mayer, for objecting creditor.

J. B. McPHERSON, District Judge. It is impossible, I think, to read the bankrupt's testimony without coming to the conclusion that he failed to keep such books of account or records as would disclose his financial condition. If, therefore, it may fairly be inferred from all the evidence that such failure was due to an intent to conceal his condition, the act forbids his discharge. No doubt there is some ground for the argument that the confusion and omissions that may easily be discovered in the books and papers under examination were largely due to the bankrupt's ignorance and in part to his carelessness; but I am bound to say that the total effect of the bankrupt's testimony upon my mind has been a decided impression, that, while he was probably stupid and without much education, he had had a sufficient business experience to know at least the general outlines of what a merchant's books and records ought to show, and that his unusual vagueness of explanation and his continual resort to lack of recollection were quite as likely to be feigned as to be genuine. Under such circumstances, much depends on how the witness behaved under examination, and, as I did not enjoy the advantage of observing his demeanor on the stand, I feel unable to decide that the findings of the referee were plainly wrong. If the well-established rule is to be followed that a man must be presumed to intend the natural consequences of his act—a presumption which he must overcome after the act has been proved from which the consequences follow—it is difficult to avoid the inference that he intentionally so kept his books and records as to conceal his financial condition from his creditors.

It is unnecessary to consider the other charge of concealing or misapplying some of his property.

The recommendation of the referee is approved, and the discharge is refused.

*For other cases see same topic & § NUMBER in Dec. & Am. Digs. 1907 to date, & Rep'r Indexes

In re VAN BUREN.

(District Court, S. D. New York. November 5, 1908.)

No. 11,521.

BANKRUPTCY (§ 217*)—STAY OF PROCEEDING ON JUDGMENT—VACATION.

An order staying a judgment creditor of a bankrupt, whose judgment is provable in bankruptcy, from proceeding to collect his judgment for one year, or until the bankrupt's application for a discharge has been disposed of, will not be vacated because, under Code Civ. Proc. N. Y. § 1391, as amended by Laws 1908, p. 433, c. 148, the creditor is entitled to take under execution 10 per cent. of the debtor's salary, since a discharge would be a bar to the enforcement of the judgment against any property of the bankrupt, although acquired after the bankruptcy; but the court in such case may impound 10 per cent. of the bankrupt's salary until the right to discharge has been determined.

[Ed. Note.—For other cases, see Bankruptcy, Cent. Dig. § 330; Dec. Dig. § 217.*]

In Bankruptcy. On motion to vacate stay.

Arthur L. Davis, for judgment creditor.

Joseph S. Rosalsky, for bankrupt.

HOLT, District Judge. This is a motion to vacate a stay of proceedings upon a judgment recovered against the bankrupt. Judgment was recovered October 6, 1908, and an execution issued on October 8, 1908, pursuant to section 1391 of the New York Code of Civil Procedure, as amended by Laws 1908, p. 433, c. 148, which authorizes a judgment creditor to take under execution 10 per cent. of the salary of a judgment debtor. The debtor was adjudicated a voluntary bankrupt on October 22, 1908. Thereupon an order was granted in the usual form, staying the judgment creditor from proceeding to collect his judgment for one year from the date of the adjudication, or, if the bankrupt in the meantime should apply for a discharge, until the determination of his application for discharge. The judgment creditor moves to vacate the stay on the ground that the present salary of the bankrupt is the property of the bankrupt, that the trustee in bankruptcy has no interest in it, and that this court, therefore, cannot enjoin the collection of one-tenth of the salary under the provisions of the recent amendments of the law.

But the judgment was recovered before the adjudication in bankruptcy. All the bankrupt's property down to the time of the adjudication is applicable to the payment of that judgment ratably with the bankrupt's other debts; but the discharge of the bankrupt, if it shall be granted, is a bar to the enforcement of that judgment against any property subsequently acquired. Under these circumstances, I think that the enforcement of the judgment against any portion of the bankrupt's present salary should be enjoined until the question is determined whether he shall receive a discharge. But as, if the entire salary were paid to the bankrupt, the probability is that the judgment creditor would never collect the tenth to which he is entitled if a discharge is refused, an order will be made directing the bankrupt's em-

*For other cases see same topic & § NUMBER in Dec. & Am. Digs. 1907 to date, & Rep'r Indexes

ployers to withhold a tenth of the salary until that question is determined.

The motion to absolutely vacate the stay, however, is denied.

SAN FRANCISCO GAS & ELECTRIC CO. v. CITY AND COUNTY OF SAN FRANCISCO et al.

(Circuit Court, N. D. California. October 26, 1908.)

No. 14,742.

1. INJUNCTION (§ 138*)—SUIT AGAINST MUNICIPALITY—PERSONS BOUND.

In a suit by a gas company against a city and its officers to enjoin the enforcement of an ordinance fixing the price of gas to be charged to all consumers as unconstitutional, where the defendant is itself a consumer and the total number of such consumers is so large as to preclude their being made parties, and the bill alleges that under the ordinance and statutes of the state any consumer may maintain an action to compel complainant to furnish gas at the rate prescribed by the ordinance or to recover a penalty on its refusal, a temporary restraining order granted pending a hearing may properly include all consumers although not parties to the record, such consumers being the real parties in interest and represented by the municipality.

[Ed. Note.—For other cases, see Injunction, Cent. Dig. § 310; Dec. Dig. § 138.*]

2. INJUNCTION (§ 149*)—TEMPORARY RESTRAINING ORDER—CONDITIONS.

In such case, however, the court may properly require complainant to pay into court any excess above the ordinance rate collected from consumers while the restraining order is in force, to be disposed of by the court on the final determination of the case.

[Ed. Note.—For other cases, see Injunction, Dec. Dig. § 149.*]

In Equity. On motion to modify temporary restraining order.

Garret W. McEnerney, for complainant.

Percy V. Long, City Atty., and Thomas E. Haven, Deputy City Atty., for defendants.

VAN FLEET, District Judge. This is an application to modify the temporary restraining order heretofore made in this cause. There are in fact two separate motions, but they may be treated and considered as one. The order was granted under these circumstances: On July 9, 1908, the complainant filed its bill in this court, praying that it be adjudged that a certain ordinance of the city and county of San Francisco purporting to fix gas rates be declared void, because in contravention of the fourteenth amendment to the Constitution of the United States; that complainant be granted an injunction, both temporary and permanent, against the defendants, enjoining and restraining them and each of them and all persons acting by or under their authority, as officers, agents, servants, employes, or otherwise, from in any way enforcing or attempting to enforce the ordinance or any of its provisions against the complainant, and that a temporary restraining order be granted until the court could determine, upon motion and hearing, whether an injunction *pendente lite* should issue.

*For other cases see same topic & § NUMBER in Dec. & Am. Digs. 1907 to date, & Rep'r Indexes

No restraining order was made on the filing of the bill, but instead an order to show cause was granted, returnable on July 13, 1908, when by consent the hearing was continued until July 14th. At the latter time the defendants appeared by the city and county attorney, and moved on affidavit for a continuance of at least 30 days; whereupon this occurred:

"Mr. McEnerney: If your honor please, when we applied to your honor we might have applied for a restraining order. We did not. We applied for just a plain order for a summary hearing, and if this matter should go over for any length of time—I lay out of view any personal concern that I may have in it—it is only due to our clients that we should have a restraining order.

"The Court (to the city and county attorney): I suppose you would consent to the matter remaining in statu quo, would you not, during the pendency of any continuance?

"Mr. Long: While we cannot consent—if your honor please, I do not feel justified in consenting—at the same time we will not seriously object. I have not the power, may it please the court, to consent to the making or the entering of any such order.

"The Court: I suppose the court could impose that as a condition, that the parties stand restrained pending the hearing of the preliminary application.

"Mr. Long: I take it that your honor could do that.

* * * * *

"Mr. Long: As I understand the ruling of your honor, it is that the continuance is granted upon this condition; that is, you impose a condition. I would like to have that in the record in order to escape any criticism.

"The Court: Oh yes, that is understood.

"Mr. McEnerney: And the bond is fixed at \$150,000.

"The Court: Yes."

Thereupon the court, adopting the course pursued in that respect in *Consolidated Gas Company v. Mayer* (C. C.) 146 Fed. 150, granted the defendants a continuance of the hearing until September 8, 1908, upon condition that a restraining order issue pending the hearing, upon complainant giving a bond in \$150,000.

It may be true, as suggested, that the attitude of the city and county attorney, as thus appearing of record, was tantamount to a consent that the restraining order issue; but while this might prevent defendants from having the order in its entirety set aside, I do not think it can be held to preclude their right to move for its modification in any proper respect. The order restrained the defendants named in the bill, their servants, employes, agents, etc., and "all consumers of gas furnished by complainant, and each of said consumers," from in any manner or in any wise attempting to enforce said ordinance or the rates therein established until the further order of the court. Defendants now ask that the order be modified in two particulars: (1) By striking out the provisions thereof which include consumers within its terms of restraint; and (2) by providing for the impounding by the court of any excess above the rate fixed by the ordinance involved which may be collected by the complainant pending the determination of the order to show cause.

The substantial ground upon which the first modification is asked is that, the consumers not being named as parties to the bill, the court was without jurisdiction to include them within the terms of its order. It is alleged in the bill that the defendant city and county of San Fran-

cisco has been and still is a consumer of the gas manufactured, distributed, and sold by the complainant, and has the right to require the complainant to furnish and deliver unto it gas for the purpose of illuminating the public streets and public buildings of the city and county of San Francisco at such legal and valid rates as may be prescribed by the city and county under and pursuant to the provisions of the Constitution in that behalf; and that complainant will be compelled to furnish and supply the city and county with gas for illuminating its said public streets and buildings at rates not exceeding the maximum rates prescribed by the ordinance. It is further alleged that the private or individual consumers of gas within the municipality exceed 50,000 in number, and that:

"Under and pursuant to the provisions of sections 629 to 632, both numbers included, of the Civil Code of the state of California, your orator is required to supply gas for illuminating purposes, at such rates as may have been legally established by said city and county, to the owner or occupant of any building or premises in said city and county and distant not more than one hundred feet from any of its gas mains, upon demand therefor being made, and upon the applicant paying or tendering all money due from him; and it is expressly provided in section 629 of said Civil Code that if, for the space of ten days after application therefor is made by any person entitled to gas service under the provisions of said section, the corporation to whom such application is made refuses or neglects to supply gas as required for the purposes of illumination, such corporation must pay to the applicant the sum of fifty dollars (\$50.00) as liquidated damages, and five dollars (\$5.00) per day as liquidated damages, for every day such refusal or neglect continues thereafter."

And it is alleged that:

"The defendants and many other consumers of gas residing in said city and county will, in case of your orator's refusing to comply with said ordinance, institute proceedings and actions at law to compel your orator to furnish them with gas at the rate prescribed by said ordinance, and to recover the penalties prescribed by said section 629 of the Civil Code of the state of California, and that your orator will thereby be irreparably damaged and subjected to a multiplicity of suits and proceedings."

Was it within the power of the court, under these facts, to include the general body of consumers within the restraint of the order? This depends upon whether such consumers, although not named as parties to the bill, are in contemplation of law to be regarded as such for the purposes of the relief sought. While it is undoubtedly the general rule that an injunction will not lie against one not a party to the bill, this rule is subject to certain well-defined exceptions. One of these exceptions is where the parties concerned are so numerous as to make it practically impossible to bring them all before the court, but, the right involved being common to all, one or more being made parties are permitted to represent all, or where those who are impleaded stand, under the law, in a representative or trust relation to those who are not. In such instances, where under the circumstances the decree would bind all, those not made parties are deemed to be potentially so, and as such within the jurisdiction of the court. The rule is thus stated in *Smith v. Swormstedt*, 16 How. 303, 14 L. Ed. 942:

"Where the parties interested in the suit are numerous, their rights and liabilities are so subject to change and fluctuation, by death or otherwise, that it would not be possible, without very great inconvenience, to make all of

them parties, and would oftentimes prevent the prosecution of the suit to a hearing. For convenience, therefore, and to prevent a failure of justice, a court of equity permits a portion of the parties in interest to represent the entire body, and the decree binds all of them the same as if all were before the court. The legal and equitable rights and liabilities of all being before the court by representation, and especially where the subject-matter of the suit is common to all, there can be very little danger but that the interest of all will be properly protected and maintained."

This rule is peculiarly applicable to cases like the present. Here the real parties in interest are the ratepayers or consumers—the public. The ordinance fixing the rate is for the benefit of the latter, not for that of the supervisors or municipality alone. The supervisors are acting in a purely representative capacity. They stand for and represent, not only the municipality, but the entire community or body of consumers, and in this respect they must be regarded as occupying the relation of trustees to the latter. As stated by Mr. Freeman in section 178 of his work on Judgments:

"The position of a county or municipal corporation towards its citizens and taxpayers is, upon principle, analogous to that of a trustee towards his cestuis que trust, when they are numerous and the management and control of their interests are by the terms of the trust committed to his care. A judgment against a county or its legal representatives in a matter of general interest to all its citizens is binding upon the latter, though they are not parties to the suit."

Here the purpose of the action is not only to have the obnoxious regulation declared void as violative of complainant's constitutional rights, but to have the enforcement of that rate restrained pending the determination of its validity, that complainant may not suffer irreparable wrong in the meantime through the bringing by individual consumers of a multiplicity of actions to enforce it. It being practically impossible, indeed prohibitive, in such a case to make each individual ratepayer a party, the law is satisfied by joining with the ratemaking body the board of supervisors, the city and county, which latter is not only itself a consumer, but stands as a representative of the entire body of consumers within the municipality. This principle was involved in the case of *San Diego Land Co. v. Jasper* (C. C.) 110 Fed. 702, 712, decided by Judge Ross. In that case the board of supervisors was made defendant, and with it were joined the petitioners upon whose petition, as required by the statute, the board had acted in making the regulation. These petitioners made default, and thereupon the complainant contended that the latter were the real parties in interest, and that it was entitled ipso facto upon their default to a decree against all the defendants. But this relief was denied, the court saying:

"The answer to the first point is that each and every person to whom the rates fixed apply—in other words, the public—is interested in the question, and the representative of this public in the matter is the board of supervisors, each member of which was by the complainant made a party defendant to the suit, and all of whom appeared to the bill and interposed a defense in behalf of all parties interested. This practice has been uniformly sanctioned and held to be proper. *Railway Co. v. Minnesota*, 134 U. S. 418, 10 Sup. Ct. 462, 702, 33 L. Ed. 970; *Reagan v. Trust Co.*, 154 U. S. 362, 14 Sup. Ct. 1047, 38 L. Ed. 1014; *Railroad Co. v. Smith*, 128 U. S. 174, 9 Sup. Ct. 47, 32 L. Ed. 377; *Stone v. Railroad Co.*, 116 U. S. 353, 6 Sup. Ct. 349, 29 L. Ed. 651; Rail-

way Co. v. Gill, 156 U. S. 649, 15 Sup. Ct. 484, 39 L. Ed. 567; San Diego Land & Town Co. v. City of National City (C. C.) 74 Fed. 79; id., 174 U. S. 739, 19 Sup. Ct. 804, 43 L. Ed. 1154; Peik v. Railway Co., 94 U. S. 164, 24 L. Ed. 97."

This case went to the Supreme Court (San Diego Land & Town Company v. Jasper, 189 U. S. 439, 23 Sup. Ct. 571, 47 L. Ed. 892), and that Court, in affirming the decree of the Circuit Court, said:

"The default of the petitioner is relied upon as the ground of expressions in one or two cases here and elsewhere, that the duties of the supervisors are judicial in their nature. Spring Valley Water Works v. Schottler, 110 U. S. 347, 354, 4 Sup. Ct. 48, 28 L. Ed. 173; Jacobs v. Board of Supervisors, 100 Cal. 121, 130, 34 Pac. 630. The conclusion drawn is that when the original plaintiffs disappear the case is at an end. We need not stop to consider to what extent or for what purposes the proceedings before the supervisors properly may be termed judicial. See, further, San Diego Land & Town Co. v. National City, 174 U. S. 739, 750, 19 Sup. Ct. 804, 43 L. Ed. 1154; Cambridge v. Railroad Commissioners, 153 Mass. 161, 170, 26 N. E. 241. It is obvious that they are not so in such a sense as to do the appellant any good. The petitioners did not complain of injury to any private interest of theirs. They had none. They appeared on behalf of the public only and asked purely legislative action in the form of a general rule for the future to govern the public at large. San Diego Land & Town Co. v. National City, *ubi supra*; Spring Valley Water Works v. San Francisco, 82 Cal. 286, 22 Pac. 910, 1046, 6 L. R. A. 756, 16 Am. St. Rep. 116; Smith v. Strother, 68 Cal. 194, 8 Pac. 852; In re Janvrin, 174 Mass. 514, 55 N. E. 381, 47 L. R. A. 319. As soon as such a rule was established, if not as soon as a hearing was begun, the petitioners were merged in the public affected by the rule. The present bill is an independent proceeding to have the ordinance declared void. In such a case the body making the regulation is the usual, proper, and sufficient party respondent, and the default of those who set the original proceedings in motion is immaterial, so long as it defends the case."

Again, in Railway Company v. Minnesota, 134 U. S. 418, 10 Sup. Ct. 462, 702, 33 L. Ed. 970, Mr. Justice Miller, in his concurring opinion, discussing a similar question, said:

"(5) But until the judiciary has been appealed to to declare the regulations made, whether by the Legislature or by the commission, voidable for the reasons mentioned, the tariff of rates so fixed is the law of the land, and must be submitted to both by the carrier and the parties with whom he deals.

"(6) That the proper, if not the only, mode of judicial relief against the tariff of rates established by the Legislature or by its commission, is by a bill in chancery asserting its unreasonable character and its conflict with the Constitution of the United States, and asking a decree of court forbidding the corporation from exacting such fare as excessive, or establishing its rights to collect the rates as being within the limits of a just compensation for the service rendered.

"(7) That until this is done it is not competent for each individual having dealings with the carrying corporation, or for the corporation with regard to each individual who demands its services, to raise a contest in the courts over the questions which ought to be settled in this general and conclusive method."

See, also, St. Louis & S. F. R. Co. v. Gill, 156 U. S. 649, 15 Sup. Ct. 484, 39 L. Ed. 567; Reagan v. Trust Co., 154 U. S. 362, 14 Sup. Ct. 1047, 38 L. Ed. 1014; Smyth v. Ames, 169 U. S. 466, 18 Sup. Ct. 418, 42 L. Ed. 819; San Diego Land & Town Co. v. National City, 174 U. S. 739, 19 Sup. Ct. 804, 43 L. Ed. 1154; Spring Valley Water Works v. San Francisco, 82 Cal. 286, 22 Pac. 910, 1046, 6 L. R. A. 756, 16 Am. St. Rep. 116. These cases proceed upon the theory that the rights to be protected under the regulating ordinance, and which

complainant has assailed, are public rights, and that the only practicable way of making the public a party is by suing its representatives; that when this is done the individuals composing the public are, equally with the parties named in the bill, bound by every step properly taken in the action, and may, therefore, be included in and restrained by the injunctive orders of the court.

It was upon this principle that Judge Morrow, by his injunction granted in *Spring Valley Waterworks v. San Francisco* (C. C.) 124 Fed. 574, an action to declare void an ordinance fixing water rates in the city and county of San Francisco, included the entire body of consumers, restraining the latter, equally with the defendants of record, from in any wise seeking to enforce the ordinance pending suit. Touching that question Judge Morrow says:

"In this discussion I have not considered the controversy concerning hydrant rates for water supplied to the city, alleged by the complainant to be unreasonably low, nor have I considered the water rates for public buildings paid for by the city. The questions discussed have had relation only to the rights of private consumers, and in this connection the court at the close of the oral argument suggested a query as to the effect of an injunction upon private consumers directed to the defendants the board of supervisors, or the officers of the municipal corporation. An examination of the authorities submitted by the counsel for the complainant with this question in view has satisfied me that there will be no difficulty in this aspect of the case. The board of supervisors, or the municipal corporation, or perhaps both, represent the water ratepayers in this controversy, and are bound by the proceedings. This has been established by abundant authority."

A like course was followed by Judge Morrow in the more recent case of *San Joaquin, etc., Canal Company v. Stanislaus County* (No. 14,554, decided June 29, 1908) 163 Fed. 567, and by Judge Gilbert in *Contra Costa Water Company v. City of Oakland* (No. 13,599) 165 Fed. 518, both in this court. And in *Spring Valley Water Company v. San Francisco* (No. 14,735, just decided by Judge Farrington) 165 Fed. 667, on motion for an injunction pendente lite, the same practice is followed and the consumers are expressly enjoined. These cases would seem to be conclusive of the question so far as this court is concerned. As against them defendants rely upon *Consolidated Gas Company v. Mayer*, above referred to; *Richman v. Consolidated Gas Co.*, 114 App. Div. 216, 100 N. Y. Supp. 81; and *Buffalo Gas Co. v. City of Buffalo* (C. C.) 156 Fed. 370. The first case was an action to have declared void a rate for illuminating gas in the city of New York. This rate had been fixed, not only by the gas commission—a rate-fixing body established by the Legislature, but the same rate had been established directly by act of the Legislature. The court, as here, had issued a temporary restraining order, as a condition for a continuance asked by defendants, prohibiting the officers specially charged with enforcing the rate from taking any step to that end pending litigation; and the motion was for an enlargement of the terms of the restraining order to extend its effect to the consumers. This feature of the motion was denied; the court, while using some general language favorable to defendant's views, very evidently placing its ruling upon the ground that the Legislature having itself fixed the rate sought to be avoided, and there being in such an instance no mode of ascertaining the basis upon which the Legislature had acted,

the presumption of the validity of the rate so fixed must obtain until the court could determine, upon final proof and hearing, that it was void, and that in the meantime its enforcement by consumers should not be enjoined. In that regard the court said:

"Irrespective of any action of the gas commission, the Legislature has itself fixed the 80-cent rate, and there is nothing to indicate upon what it predicated such action. For aught that we know, it may have reached the conclusion that the commission was in error in not including the franchises at their taxable value in the estimate of complainant's property, and may, at the same time, have concluded that 7, or 6, or even 5 per cent. was a proper return to be received by the owner of such property. This brings us to the fundamental question presented by the pleadings: Is the rate fixed by the Legislature (80 cents) so low as to be unjust or confiscatory? As was indicated at the outset of this opinion, there can be no intelligent answer given to this question until the whole case is presented upon testimony taken, not *ex parte*, but according to the rules for taking testimony in equity causes. Therefore, until the court at final hearing may have the opportunity to pass upon such a record, although the existing order is continued, its terms will not be enlarged, so as to undertake to restrain the actions of individual consumers, who are not parties to this suit and have not been served with process."

And as further indicating the special considerations moving the court to its conclusion, it is said:

"The city of New York is the largest consumer, an undoubtedly solvent consumer, and the only one made a party defendant. The rate it is to pay is not regulated by the action of the gas commission, nor by either of the two acts already considered. Chapter 736, p. 2091, of the Laws of 1905, provides that it shall pay only 75 cents per 1,000 cubic feet, and to that act there is raised an additional constitutional question not heretofore discussed. The representatives of the city and of the complainant have had no difficulty during two or three years of controversy in arranging a *modus vivendi*, whereby all rights of either side are reserved, and gas is furnished as required. It is not to be anticipated that there will be any difficulty about continuing such arrangement, but to facilitate it the order now to be entered may provide that payment by the city at the 75-cent rate, and acceptance thereof by complainant under protest, shall not operate as an accord, satisfaction, waiver, or estoppel to the prejudice of either side in any litigation pending or future. Such a clause may make it practicable for these contestants to eliminate some questions as to accruing interest."

A careful review of the whole case makes it clear that it was by reason of the particular circumstances arising from the effect of the acts of the Legislature that Judge Lacombe was led to hold that the case was outside the rule above indicated as applicable to the ordinary case where, as here, the rate is fixed by a board or commission after a hearing.

This was very clearly the view taken by the Supreme Court of New York in the second case above cited by defendants, where, passing upon the same rate, it was expressly held that, the regulation having been fixed by statute, its constitutionality must be presumed until a final judicial determination to the contrary; that until such determination can be had the consumers are entitled to service based thereon; and, further, that the rate fixed by the gas commission must be held as superseded by the act of the Legislature, and in such case the commission cannot be regarded as representing the consumers in a suit involving the validity of such legislative act. It is there said (114 App. Div. 224, 100 N. Y. Supp. 88):

"It may well be as contended by the learned counsel for the respondent, that, for the purpose of testing the validity of the action of the commissioners in fixing the 80-cent rate and the enforcement of the same, it was sufficient to make the commissioners parties, and that they upon those questions represent the consumers, who are to be benefited by their acts. *San Diego Co. v. Jasper*, 189 U. S. 439, 23 Sup. Ct. 571, 47 L. Ed. 892. It is evident, however, that it is immaterial to the rights of the plaintiff whether the statute creating the commission of gas and electricity, or the order made by that commission, be valid or invalid. The action of the commission is superseded by the statute subsequently enacted by the Legislature, which, since it contains no reference to the action of the commissioners, cannot be presumed to be based thereon. On the question of the validity of chapter 125 of the Laws of 1906, therefore, it follows that the members of the state gas commission cannot represent the private consumers."

The third case relied upon by defendants—decided by Judge Hazel in the Circuit Court for the Western District of New York—is very evidently cited under a misapprehension as to the effect of the ruling there made. The case does not, as supposed by counsel, follow *Consolidated Gas Company v. Mayer*, but the learned judge proceeds to distinguish it, and, in strict accord with the principles of *San Diego*, etc., *v. Jasper* and the other cases in line therewith, grants the injunction asked. He there says (156 Fed. 371):

"Counsel for defendant further contends that neither the city nor the inhabitants can be restrained in this suit under the doctrine announced by Judge Lacombe in *Consolidated Gas Company v. Mayer et al.* (C. C.) 146 Fed. 150, and later approved by Judge Laughlin in *Richman v. Consolidated Gas Company*, 114 App. Div. 216, 100 N. Y. Supp. 81. In the former case the court dealt with the provisions of a special act of the Legislature applicable to New York City fixing the price of gas sold to the city at 75 cents per 1,000 cubic feet. For failure to comply with its provisions, a penalty is prescribed in the act which the Attorney General or the district attorney is empowered to collect under section 1962 of the Code of Civil Procedure. For reasons stated in the opinion, the court, in the *Mayer* Case, declined to enjoin the city of New York. Such reasons, however, are not wholly applicable to this controversy, for here admittedly the city of Buffalo and its mayor threatens to compel the enforcement of Laws 1905, p. 2100, c. 739, which provides under section 20 that the commission, or any person, corporation, or municipality interested in the enforcement of such order, may apply to the Supreme Court for a writ of mandamus to compel compliance with such order. This court is therefore persuaded that the city of New York was not enjoined by Judge Lacombe because in that case the Attorney General and the district attorney, who were parties, were charged with the responsibility of recovering the specified penalty for noncompliance with the statute, and also because the price for gas to the city of New York was fixed by the Legislature at a less sum than that charged consumers; while in this case the city of Buffalo, in the absence of a contract providing for a less price, probably is liable for an amount equal to that charged the individual consumer. In any event, the action of the commission declares what shall be the maximum price to consumers of gas, and concededly the city is one of complainant's customers."

It will thus be seen that the first two of these cases are not necessarily at variance, while the last is in harmony with the principles above announced and by which the court was actuated in granting the order.

It is also urged that as matter of discretion the restraining order should be modified in the particular involved, since to permit it to stand in its present form will operate a hardship upon consumers by compelling them to pay an increased rate for gas over that fixed by

the ordinance. This is based upon the fact, disclosed at the argument, that since the making of the order the complainant has inaugurated a charge of \$1 per thousand feet to consumers instead of a rate of 85 cents as fixed by the ordinance. The restraining order gives no authority to complainant in any express way for this course, nor was any such authority asked when the order was made, although it was disclosed in the discussion between counsel that some such course was in contemplation. While the propriety of such practice has been given countenance in *Consolidated Gas Company v. Mayer*, supra, and more recently by Judge Farrington in the *Spring Valley Water Case*, its propriety has not been passed upon in this case, nor in any direct way presented for consideration, and it will be time enough to consider it when brought up in some direct or appropriate manner. The only question now before the court is whether, under the circumstances disclosed, the court would be warranted in the exercise of its discretionary power in relieving the consumers from the restraint of the order by reason of the inconvenience or hardship to result from such increased charge proposed to be made by the complainant. This discretion—it is hardly necessary to say—must be a just and legal exercise of the power of the court, having in view its effect upon the rights of both parties to the controversy, and to be largely governed by a consideration of the question as to which side would suffer the greatest inconvenience from the court's action. Considering the character of the litigation and the object sought to be attained by the order in question, it would seem to involve largely a denial of justice to complainant to withdraw the restraint of the order from the consumers. One of the main purposes of the action is to restrain the enforcement of the obnoxious rate pending the determination of its validity, that the complainant may not be put to irreparable loss and damage in the meantime. Of what real benefit to complainant would be a restraint of the supervisors and the city—as to whom defendants concede the order is proper—if every individual consumer were left at liberty to insist upon an enforcement of the ordinance, with a free hand to involve the complainant in a maze of costly litigation should it refuse their demands? Complainant could be afforded absolutely no adequate redress against loss occurring as the result of such a course. On the other hand, against any inconvenience or hardship suffered by a consumer in having to pay an increased charge for the commodity, he can be fully protected by an adequate bond from the complainant or other measure for safeguarding his rights. In this respect the proper rule and its reason is very aptly stated by Judge Gilbert when granting the temporary injunction in the *Contra Costa Water Case*, supra, where he says:

"A temporary restraining order will work no substantial injury to the defendants or to the consumers of water. They will be amply protected by a bond to cover the amount by which the rates are reduced by the resolution. On the other hand, if the order were denied and the contention of the complainants should finally be sustained, it is evident that the complainant would be subjected to serious inconvenience and injury, notwithstanding the remedy afforded it by that section of the resolution which permits it to shut off water from premises on which the rentals are 30 days in arrears, and would be required to bring a multiplicity of suits, which it is one of the functions of a

court of equity to prevent. It is a settled rule for the guidance of the discretion of courts in cases such as this to look to the balance of injury and inconvenience and to consider whether a greater injury will be done by granting than by refusing an injunction. In *United States v. Duluth*, 1 Dill. 474, Fed. Cas. No. 15,001, Mr. Justice Miller said: 'When the danger or injury threatened is of a character which cannot be easily remedied if the injunction is refused, and there is no denial that the act charged is contemplated, the temporary injunction should be granted unless the case made by the bill is satisfactorily refuted by the defendant.' See, also, *Palatka Water Works v. City of Palatka* (C. C.) 127 Fed. 101, and *City of Newton v. Levis*, 79 Fed. 715, 25 C. C. A. 161, and cases there cited, and *Indianapolis Gas Co. v. Indianapolis* (C. C.) 82 Fed. 245."

It is obvious to my mind that to grant the modification asked would render the order of no real protection to the complainant, but leave it subject to practically all the ills of which it complains. It would be an injunction in form which did not in fact enjoin; a granting of the shadow while withholding the substance. From these considerations I entertain no doubt as to the propriety of the restraining order in the respect under consideration, and that the modification asked for should be disallowed.

As to the second motion involved in the application, that to so modify the restraining order as to provide for the impounding by the court, to await its final action, of such sums as may be collected by complainant from consumers in excess of the ordinance rate, I think this should be granted. The only objections urged by complainant against such action are (1) the inconvenience to and onerous duty that will be cast upon the clerk in caring for such fund, and (2) that the rights of the consumers are amply protected by the bond heretofore given by the complainant. As to the first, it is a consideration with which the complainant is not concerned. As to the second, it appears that the excess collected by complainant will amount to something like \$25,000 per month, from which it can readily be seen that it will take but a short period before the fund will exceed the amount of the bond already given; and while, as suggested, complainant could be required to give an additional bond, I am of opinion that the method proposed by the motion will afford a more satisfactory and perfect protection to those from whom the fund is collected. It is sanctioned by the course adopted in *Consolidated Gas Company v. Mayer*, supra, and by Judge Farrington in the *Spring Valley Case*, and can certainly work no harm to either side. A modification of the order may, therefore, be had conforming it in that respect substantially to the orders in those cases, the details thereof to be settled by the court should counsel fail to agree thereon.

In accordance with these views, the motion first discussed will be denied; the second will be granted.

UNITED STATES v. McVICKAR et al.

(Circuit Court, S. D. New York. November 4, 1908.)

POST OFFICE (§ 48*)—USE OF MAILS TO DEFRAUD—INDICTMENT.

Under Rev. St. § 5480 (U. S. Comp. St. 1901, p. 3696), making it a criminal offense to deposit a letter in a post office for the purpose of executing a scheme to defraud, the provision that "the indictment, information, or complaint may severally charge offenses to the number of three when committed within the same six calendar months; but the court shall thereupon give a single sentence * * *," does not prevent the joinder in one indictment of counts charging offenses in different periods of six months, nor the imposition of sentence on each of such counts in case of conviction thereon.

[Ed. Note.—For other cases, see Post Office, Dec. Dig. § 48.*]

On Motion to Arrest in Judgment.

Henry L. Stimson, U. S. Atty.

Marx, Houghton & Byrne, for defendants.

CHATFIELD, District Judge. All counts in this indictment are based upon the provisions of section 5480 of the Revised Statutes of the United States (U. S. Comp. St. 1901, p. 3696). Each count, of which there were originally five, charged the unlawful mailing, in New York City, of a letter to one Louis E. Ruthroff, Belleville, Mich. The letter described in count 1 was signed Morgan H. Webster, and post-marked July 3, 1906; count 2 described a letter postmarked July 18, 1906, also signed Morgan H. Webster; count 3 described a letter post-marked August 5, 1906, but signed A. B. Lyons; count 4 described a letter postmarked July 13, 1908, also signed A. B. Lyons; while count 5 described a letter postmarked July 27, 1908, and also signed A. B. Lyons.

Section 5480, so far as it relates to these questions, is as follows:

"If any person having devised * * * any scheme to defraud, * * * shall, in and for executing such scheme, * * * place any letter * * * in any post office * * * such person shall be punishable by a fine * * * and by imprisonment for not more than eighteen months, or by both.

"The indictment, information, or complaint may severally charge offenses to the number of three when committed within the same six calendar months; but the court thereupon shall give a single sentence, and shall apportion the punishment especially to the degree in which the abuse of the post office establishment enters as an instrument into such fraudulent scheme and device."

It will be noted that counts 1, 2, and 3 set forth three occurrences within the space of six months during the year 1906, while counts 4 and 5 set forth two occurrences within six months during the year 1908, but more than six months elapsed between the dates of the letter of count 3 and that of count 4.

It has been held frequently, and is beyond discussion, that the depositing of a particular letter in the post office is the act denominated an offense by the statute. In re Henry, 123 U. S. 374, 8 Sup. Ct. 142, 31 L. Ed. 174. But much disagreement has arisen over the meaning of the portion of the statute permitting the joinder of three such offenses in one indictment, and providing that but one sentence shall be

*For other cases see same topic & § NUMBER in Dec. & Am. Digs. 1907 to date, & Rep'r Indexes

imposed, if conviction is had upon the three counts. In order to avoid such questions, in some instances counts have been nolle upon motion by the government, as in the case of *United States v. Nye* (C. C.) 4 Fed. 888, or if conviction has been had and but one sentence imposed, on an indictment containing more than three offenses, the conviction has been allowed to stand, as in the case of *In re Haynes* (C. C.) 30 Fed. 767. The joinder of more than three offenses in one indictment is something that, therefore, should be questioned before sentence, and can be cured by nolleing the excess counts, or by imposing but the one sentence. In the present case, at the opening of the trial the District Attorney moved to nolle counts 2 and 5, thus leaving two counts based upon the letters during the six months within the year 1906, and one count based upon a letter mailed in the year 1908. This action of the District Attorney made it unnecessary to consider whether more than three offenses were united in the one indictment, but has still left open any question that may be raised because the three offenses charged were not alleged to have been committed within the same six months. The trial has resulted in a verdict of guilty. The defendants have moved for a new trial, and this motion has been denied. They have now further moved in arrest of judgment, upon the ground that the indictment as in its final form, and the question which was allowed to go to the jury, and the judgment of the jury itself, cannot stand, and that no sentence can be imposed, inasmuch as the indictment presented a charge not legal under section 5480 in the portions above quoted.

The particular objection is that section 5480 is claimed to allow the government to charge offenses only to the number of three, and only when committed within the same six calendar months. This contention has been upheld in the case of *Bass v. United States* decided by the Court of Appeals of the District of Columbia on the 4th day of June, 1902, and reported in 20 App. D. C. 232. The court in that case refers to the matter of *In re Henry*, supra, and to the case of *McElroy v. United States*, 164 U. S. 76, 17 Sup. Ct. 31, 41 L. Ed. 355, from which it draws the conclusion that two indictments, consolidated under section 1024 of the Revised Statutes (U. S. Comp. St. 1901, p. 720), and tried as one, could not, in the consolidated form, express occurrences three in number, but not committed within the same six months. On this ground a new trial was ordered.

As has been said, if the indictment was unsupportable as a whole because of this defect, it might be cured by a sentence of but one term, without specifying whether imposed upon the first, second, or last count covered by the verdict. *In re Haynes*, supra. Or this point might have been raised upon the motion for a new trial, and disposed of at that time. But inasmuch as this court is not inclined to agree with the conclusions in the case of *Bass v. United States*, supra, and inasmuch as the court intends to impose sentence upon each of the three counts, it seems proper to discuss the motion upon the merits, and determine it so far as this court is concerned.

It will be necessary to refer to a few of the cases arising under section 5480. *In re Henry*, supra, was perhaps one of the earliest of the cases that must be considered, having been decided in 1887. In that case the Supreme Court of the United States upheld the sentence and

conviction of the defendant upon three charges of offenses committed within the same six calendar months, and apparently with relation to the same scheme to defraud, and perhaps even of letters addressed to the same person, as had been the three offenses for which the defendant had been indicted, tried, and convicted in the same court, and already served a term of imprisonment before his second arrest. The court held, apparently, that the provisions of section 5480 meant merely that for three offenses, or three acts of mailing, one term of imprisonment should be imposed, but that a separate charge or a separate punishable series of offenses could be based upon every three letters. The court did not seem to consider anything happening outside of the space of six months, nor whether Congress intended to limit the prosecution with reference to any one particular scheme to defraud a single person to three offenses and no more, unless the operation of the scheme overran the period of six months.

In 1884, the case of *United States v. Loring* (D. C.) 91 Fed. 881, held that in a single indictment any number of counts could be included charging different acts in pursuance of the same scheme, but that the prohibition of the statute related to the joining of more than three offenses relating to different schemes or frauds.

While in 1886, in *United States v. Martin* (D. C.) 28 Fed. 812, the court held that any number of indictments, so long as each indictment set forth three separate and distinct charges, could be maintained against a defendant, thus following the apparent reasoning of the case of *In re Henry*, supra.

In 1900, the United States Supreme Court, in *Re De Bara*, 179 U. S. 316, 21 Sup. Ct. 110, 45 L. Ed. 207, approved of the joinder of nine indictments, each charging three offenses, upon which a verdict as to some counts of each of the indictments was rendered against the defendant, and a sentence of three years' imprisonment imposed. The provisions of section 5480, as approved by the Supreme Court, are held to mean merely that three offenses within the same six months may be joined for the purpose of one charge, and that a number of such charges, if presented in the form of separate indictments, can be consolidated and a cumulative sentence be imposed.

Further, in the case of *Betts v. United States*, 132 Fed. 228, 65 C. C. A. 452, decided in 1904, and in the case of *Hanley v. United States*, 127 Fed. 929, 62 C. C. A. 561, also decided in 1904, the consolidation of several indictments is approved of, and the power to impose the full sentence for the charges contained in each indictment is upheld.

In the case of *United States v. Clark* (D. C.) 125 Fed. 92, the court criticises a general count charging the defendants with mailing some 500 letters, etc., to persons unknown, and says that "but three offenses committed within the same six calendar months can be joined in the same indictment, to say nothing of the same count. This does not prevent the government from prosecuting other offenses of the same character which have occurred within the period mentioned; that is to say, it is not required to select out three, and condone all the others."

None of the cases above referred to except the Bass Case, however, bear upon the particular point in question, and it is necessary to de-

termine whether the words, "The indictment * * * may severally charge offenses to the number of three when committed within the same six calendar months," should be interpreted to have, as if inserted or understood, "and no others." Even this might be gotten around by drawing separate indictments and consolidating them, but inasmuch as we are considering a single indictment, we must pass upon the strongest case for the defendant, and the other cases would naturally follow.

The purpose of this section may have been to prevent multiplicity of charges, in a matter where numerous offenses of the same sort might grow out of a series of correspondence, or the purpose of the statute may have been to insure the defendant against 18 months' imprisonment, if his operation of the scheme to defraud did not exceed the mailing of three letters. The majority of the cases, including the decision of the Supreme Court, would seem to indicate that the latter is the interpretation to be given to the statute.

The intention of Congress with regard to the statute could be easily made clear if Congress had or should desire to alter the effect of the statute as now interpreted by the Supreme Court; but as Congress has not amended the statute since these interpretations, and inasmuch as there is no apparent reason why Congress should have provided for a great number of indictments charging three offenses each, based upon letters sent within six months, and also have prevented further prosecutions in the same fraud, if the sending of letters happened to extend beyond the period of six months, this court can see no basis for the present motion.

A criminal statute should be construed strictly, and a strict construction of this statute would prevent reading into the statute the words insisted upon by the defense. This application of the doctrine has been recently upheld in this circuit, in the case of *Krakowski v. United States* (C. C. A., March Term 1908), 161 Fed. 88, and it does not seem that further argument as to the application of the particular section is necessary.

THE UCAYALI.

(District Court, E. D. New York. November 17, 1908.)

1. EVIDENCE (§ 398*)—PAROL EVIDENCE TO VARY WRITING—CONTRACT OF SERVICE.

The contract of service of a seaman as evidenced by the shipping articles cannot be changed by parol evidence unless fraud is clearly established.

[Ed. Note.—For other cases, see Evidence, Cent. Dig. § 176; Dec. Dig. § 398; * Seamen, Cent. Dig. § 23.]

2. SEAMEN (§ 3*)—ACTION BY FOREIGN SEAMAN FOR WAGES—JURISDICTION OF UNITED STATES ADMIRALTY COURTS.

Libelant, who was a British seaman, signed articles in England for service on an English ship, to return to a British port for discharge, the articles also providing that if he claimed a discharge in the United States

*For other cases see same topic & § NUMBER in Dec. & Am. Digs. 1907 to date, & Rep'r Indexes 164 F.—57

he should be paid wages at the rate of 5 shillings per month. On reaching New York he had a dispute with the mate, who told him to leave the vessel, but he did not do so, and on the next day was told by the captain to go to work, and that if he left he would only be paid the 5 shillings per month. He subsequently left the vessel, with the consent of the mate, but was given an opportunity to return by the British consul, who also told him if he did not he would be entitled to only such wages, and on his refusal to return posted him as a deserter. *Held*, that the mate had no authority to discharge him, and that under the terms of his contract, having left the ship voluntarily, he had no right of action against the ship which would be enforced by a court of admiralty of the United States, although such court might properly entertain jurisdiction to investigate the facts, but that he would be left to his remedy under the British law, by which his contract rights were governed.

[Ed. Note.—For other cases, see Seamen, Dec. Dig. § 3.*]

In Admiralty.

For prior opinion, see 159 Fed. 800.

Robert W. Imbrie, for libellant.

Whitridge, Butler & Rice, for claimant.

CHATFIELD, District Judge. Thomas Murray, the libellant, was a seaman upon the steamer *Ucayali*, who signed articles for the voyage in question at Liverpool, England, in company with a number of other sailors and petty officers, "for a voyage to Iquitos and/or if required to any port or ports within the North Atlantic and South Atlantic Ocean," etc., until the ship returned to a final port of discharge in the United Kingdom, for any period not exceeding 24 months. The articles also contain the provision that any member of the crew claiming his discharge in the United States of America will be paid off at the rate of 5 shillings per month. After a voyage of more or less duration, and upon the arrival of the vessel at the port of New York, some dispute arose between Murray and the mate of the vessel, on the day after Christmas, resulting in the mate telling Murray to pack his bag and leave the vessel. At this time some \$72.30 had been earned by Murray, against which \$33.36 had been drawn, leaving a balance of \$43.96 due to Murray, according to his computation. These figures are substantially admitted by the claimant.

It appears from the testimony that Murray did not leave the vessel when ordered to by the mate, but complained of illness, did some little work that day, and the following morning was told by the captain to go to work, or that if he liked he could be paid off at the rate of 5 shillings a month, which Murray refused. Subsequently the mate asked him if he was going ashore and gave him a pass, whereupon Murray went ashore, and after some few days appeared before the British consul, who upheld the decision of the captain, and advised Murray that he was entitled to but 5 shillings per month, if he wished to be paid off in New York. Upon Murray's refusal to accept this amount, he was marked upon the ship's articles as a deserter, and subsequently enlisted for another voyage from New York, on a different vessel. The amount of Murray's wages has been paid into the British Board of Trade, according to the requirements of the British law, in the sum of £11. 17s. 10d.

*For other cases see same topic & § NUMBER in Dec. & Am. Digs. 1907 to date, & Rep'r Indexes

Upon the trial it developed that Murray signed the articles with the rest of the crew, but after many of them had signed. He claims that the articles were not read to him, and that his understanding was that the voyage of the ship was to end at Iquitos. His contention upon this point cannot be sustained. The circumstances under which he signed, and the written contract as evidenced by the articles of the ship, cannot be changed by parol evidence, unless fraud is clearly established. There is nothing in the case to show that Murray did not ship for the voyage upon which the other sailors were entering, and he assumed the risk of agreeing to the details of the contract if he did not inquire about them before signing. Again, when the occurrences at New York are considered from the standpoint of the contract made by Murray, it is apparent that the actions of the mate were not equivalent to a breach of Murray's contract, nor to a discharge in violation of that contract. The disagreement with the mate was only effective in so far as it was ratified by the captain, or unless the mate, acting with the authority of the captain, prevented Murray from carrying out his part of the contract. No such situation is shown. Twenty-four hours after the difference with the mate, the captain offered Murray an opportunity to remain upon the ship, provided he obeyed the ship's discipline, and Murray insisted upon a discharge, with the payment of full wages, instead of at the stipulated rate of 5 shillings per month. Murray then left the ship, with the approval of the mate, but after the conditions laid down by the captain had been made clear to him, and after he had refused to remain upon the vessel and do what was ordered him as a member of the crew. Subsequently, before the British consul, opportunity was given him to change his mind, and he was told by the vice consul that, if he had determined to be paid off and leave the ship at the port of New York, he was entitled to no more than the stipulated rate.

Murray is a British seaman, and the occurrences were upon a British ship. His contract and his remedies, in so far as they relate to contract rights, must be governed by the British law (*The Belgenland*, 114 U. S. 363, 364, 5 Sup. Ct. 860, 29 L. Ed. 152, *The Lamington* [D. C.] 87 Fed. 752, and *The Bound Brook* [D. C.] 146 Fed. 160), and there would seem to be no breach of contract or violation of any of these rights under which Murray can have redress according to the terms of the laws of Great Britain as they must be applied in a case of the present sort. The case of *The Lamington* has to do with a cause of action arising upon an alleged tort, and in the case of *The Bound Brook* jurisdiction was expressly refused because of the provisions of the treaty between the United States and Germany. This principle was established in the case of *The Elwine Kreplin*, 9 Blatchf. 438, Fed. Cas. No. 4,426, and has been recognized in the cases of *The Burchard* (D. C.) 42 Fed. 608, and *The Welhaven* (D. C.) 55 Fed. 80. But it is definitely stated by the parties to the present action that the treaty between the United States and Great Britain contains no such provision, nor has there been any suggestion that the treaty between the United States and Great Britain is equivalent to those with other countries, under what is known as "the most favored nation" clause. *The Bound Brook*, supra, and *The Eudora* (D. C.) 110 Fed. 430.

Under the doctrine of *The Belgenland*, supra, in which the Supreme Court says that in the case of foreign seamen, suing for wages, the consent of the consul is frequently required before the court will proceed to entertain jurisdiction, but where seamen have been dismissed or treated with great cruelty, jurisdiction can be entertained even against the protest of the consul (*The Belgenland*, 114 U. S. 364, 5 Sup. Ct. 860, 29 L. Ed. 152), this case would seem to be of such a nature that inquiry was proper, but no relief should be granted, and jurisdiction will be exercised only to the point of holding that Murray has no cause of action against the steamer enforceable upon the statement of facts now shown to the court.

The contention now urged by Murray, namely, that he was wrongfully discharged by the mate, should have been urged upon the captain, and Murray should have demanded the right to complete his voyage, if he wished to protect the wages which he had already earned; or, if he desired to raise the question that he had been misled in signing the contract, he should have referred the entire matter to the British consul for settlement. It may well be that the courts of the United States should extend to a seaman, unjustly stranded or discharged, the privilege of an immediate issuance of process before the vessel can leave port; but a foreign seaman cannot ask the courts of the United States to create for him rights, under the terms of a contract, greater than would be recognized by the laws of the country in which the contract was made. Nor can a foreign seaman attempt, through the application of extraordinary remedies, to enlarge the scope of the rights upon which his claim to any remedy is based.

The proctor for the claimant has already attempted to dispute the jurisdiction of this court over any such matter, in the case of *The Ucayali* (D. C.) 159 Fed. 800, and it was there held that this point had been waived. It now appears that the court had jurisdiction and could exercise the same if proper circumstances were shown. The proctor for the claimant still insists that when he filed an answer disputing the merits of the libellant's contention, and at the same time objecting to the exercise of jurisdiction by this court, he did not thereby admit that the court possessed jurisdiction in admiralty, to the extent at least of determining whether the case was one which should be heard, and, if necessary, whether further relief should be granted. But be this as it may, this court adheres to its original construction of the law as expressed in the opinion above cited, and is now satisfied upon the testimony that no cause of action arose by the transactions between Murray and the officers of the vessel, at the port of New York, which makes it proper for this court to give any relief to the libellant, outside of leaving him to his rights under the statutes of Great Britain. Nor, under the circumstances, can the disposition of the matter already made by the British consul at New York be questioned, and it is impossible to hold that any liability rested upon the steamer *Ucayali*, or that there was any violation of Murray's rights under the laws of admiralty, as recognized in the courts of the United States.

The libel must be dismissed.

STRATTON v. ESSEX COUNTY PARK COMMISSION.

(Circuit Court, D. New Jersey. November 6, 1908.)

1. JUDGMENT (§ 949*)—JUDGMENT AS BAR—PLEADING.

Where a decree dismissing a bill does not disclose the ground of dismissal, the presumption is that it was on the merits; but such presumption is not conclusive, and, when such decree is pleaded in bar of a subsequent action, the plaintiff may by his replication plead facts showing that it was not in fact on the merits.

[Ed. Note.—For other cases, see Judgment, Dec. Dig. § 949.*]

2. PLEADING (§ 355*)—REPLICATION—DUPLICITY.

A replication, like a plea, must be single, and, while duplicity does not render it subject to demurrer, it does to a motion to strike out under the New Jersey practice.

[Ed. Note.—For other cases, see Pleading, Dec. Dig. § 355.*]

3. PLEADING (§ 290*)—REPLICATION—CONCLUSION.

A plaintiff cannot file a replication concluding with a verification to a plea which concludes to the country.

[Ed. Note.—For other cases, see Pleading, Dec. Dig. § 290.*]

4. PLEADING (§ 180*)—CONDITIONS PRECEDENT—PLEADING WAIVER IN REPLICATION.

The performance of all conditions precedent to a plaintiff's right of action, or a waiver of any or all of the same, must be pleaded in his declaration, and, where that alleges performance, plaintiff cannot, by a replication to a plea taking issue as to the performance of a specified condition, set up a waiver of the same.

[Ed. Note.—For other cases, see Pleading, Cent. Dig. § 367; Dec. Dig. § 180.*]

At Law. Action on contract. On motion to strike out replications to pleas.

See, also, 145 Fed. 436.

Gilbert Collins, for the motion.

Albert C. Wall, opposed.

LANNING, District Judge. The plaintiff has brought this suit to recover an amount alleged to be due on a building contract. The defendant's first plea to the first count of the declaration is that the claim made by that count was adjudicated in a former suit between the same parties in the court of chancery of New Jersey. After setting forth the contents of the bill of complaint filed in the court of chancery by the plaintiff here, and the answer thereto filed in that court by the defendant here, the defendant avers, by his plea, that a general replication to the answer in the chancery suit was filed by the plaintiff herein, that the case came on to be heard in the court of chancery upon pleadings and proofs, and that:

"On the ninth day of March, 1904, the cause having been duly heard and testimony having been duly taken, the said bill of complaint was by the chancellor in the said court of chancery, on motion of the said plaintiff as complainant, ordered to be, and the same was thereby, dismissed with costs to the said defendant, as by the record and proceedings thereof still remaining in the said court of chancery at Trenton more fully and at large appears; which

*For other cases see same topic & § NUMBER in Dec. & Am. Digs. 1907 to date, & Rep'r Indexes

said decree still remains in full force and effect, not in the least reversed, annulled, or in anywise made void."

The plea concludes with a verification by the record.

To this plea the plaintiff, at a former stage of the case, demurred. The demurrer was overruled because, under its admissions, the court was obliged to consider the decree set up in the plea, since it did not reserve to the complainant by any words of qualification, such as "without prejudice," or the like, the privilege of instituting other legal proceedings on the subject, as a dismissal of the bill on the merits of the cause. Leave was given to the plaintiff to withdraw his demurrer and file a replication. He subsequently filed a replication which contained, amongst other things, the averment that the court of chancery was without jurisdiction to try the merits of the cause, that the cause was cognizable only in a court of law, and that, for said "reason solely, the complaint was dismissed." In view of this averment in the replication, the defendant's demurrer to it was also overruled. *Stratton v. Essex County Park Commission* (C. C.) 145 Fed. 436. The plaintiff, nevertheless, subsequently applied for leave to amend his replication. Leave was granted, and an amended replication was filed. The defendant now moves to strike out the amended replication on the ground that it is irregular and defective, and so framed as to prejudice, embarrass, or delay a fair trial of the action.

The amended replication is not very different from the former one, but the fact that the former replication was allowed to stand on a demurrer to it does not dispose of the question as to whether the amended replication may stand on a motion to strike it out. Defects in a pleading that, in the old common-law practice, were objected to by special demurrer, are now, under the practice in New Jersey, to be objected to only by motion to strike out. The amended replication, in addition to declaring that "the sole reason for the dismissal of the said bill of complaint was that the action there depending was cognizable only in a court of law and not in a court of equity," avers that "to hold said decree a bar to the prosecution of this action would be to deprive this plaintiff of his property without due process of law, in violation of his constitutional rights secured to him by the fifth and fourteenth articles of the amendments to the Constitution of the United States." The latter of these averments is in the nature of a demurrer, and is not the pleading of any fact. The replication also declares that the bill of complaint in the court of chancery was "voluntarily withdrawn before a full investigation of the matters in issue was had by the said court of chancery," without averring what investigation the court of chancery did in fact make. It declares, further, that "the decree of the chancellor ordering that the said bill of complaint be dismissed was not a judgment or decree upon the merits of the matters in controversy in the said cause there pending in the court of chancery, or of the matters depending in this court," which is not the pleading of a fact but the expression of the opinion of the pleader. The decree set up in the plea does not appear to have been one in which the court of chancery declared that the complainant in that court had no right to any relief. It simply dismissed the bill, with costs. While the presumption is that the decree was one on the merits, it is not necessarily conclusive on that

point. If the plaintiff can prove, or thinks he can prove, that the chancellor declared that his decree dismissing the bill was granted because the complainant had an adequate remedy in a court of law and none in a court of equity, he may plead that fact by replication. In *Brandlyn v. Ord*, 1 Atk. 571, Lord Hardwicke said that where the defendant pleads a former suit he must show it was *res judicata*, or an absolute determination of the court that the plaintiff had no title. It was so held, also, in *Rosse v. Rust*, 4 Johns. Ch. (N. Y.) 300. In *Badger v. Badger*, Fed. Cas. No. 717 (1 Cliff. 237), there was an unqualified decree dismissing the complainant's bill in a former suit. The court allowed a replication to stand in which it was declared that the former bill was dismissed before hearing on the complainant's motion. In *Clark v. Blair* (C. C.) 14 Fed. 813, the defense of a former adjudication was raised. The record of the former suit showed an unqualified decree dismissing a bill, and the court said that, "where the record is silent, evidence is admissible to show what was actually litigated and determined in the former suit." In *Keller v. Stolzenbach* (C. C.) 20 Fed. 47, Judge Acheson said that where a decree in a former suit is pleaded in bar of a later suit the authorities all agree that, "in order to constitute the former judgment or decree a bar, it must appear that the point in issue was judicially determined after a hearing and upon consideration of the merits." The present action is for the recovery of moneys alleged to be due on a building contract. The question arises whether the court of chancery assumed jurisdiction of the former cause on some ground of equitable jurisdiction, as, perhaps, that of alleged fraud and the need of an accounting, and thereupon dismissed the bill on the merits, or whether it concluded that no equitable jurisdiction existed, and dismissed the bill on that ground. The plaintiff says the bill was dismissed for the latter reason. If so, there has been no adjudication on the merits, and the plaintiff should be permitted, since the decree is silent as to the reason for the dismissal, to file a proper replication tendering that issue. But the replication filed does not properly tender that issue. With the averment that "the sole reason for the dismissal of the said bill of complaint was that the action there depending was cognizable only in a court of law and not in a court of equity" are associated averments of what the court of chancery did not do, of conclusions of the pleader, and of matters of law. A replication, like a plea, must be single. Duplicity in a plea or replication is good on a demurrer, but not on a motion to strike out. *Rice v. Standard Oil Co.* (C. C.) 134 Fed. 464, 470; *Latham v. Staten Island Railway Co.* (C. C.) 150 Fed. 235. The motion to strike out the replication must therefore be granted.

The plaintiff has also filed a replication to the fourth plea of the defendant to the first count of the declaration, and the defendant moves to strike out that replication. By the first count, the plaintiff, after setting forth the provisions of the contract dated March 15, 1899, which was entered into by Hanfield & Stratton, of the one part, and the defendant in this suit, of the other part, and the assignment by Hanfield & Stratton on September 19, 1899, of all their interest in the contract to the plaintiff in this suit, makes this averment:

"And the said plaintiff avers that, after the making of the said agreement first above mentioned, the said Hanfield & Stratton entered upon the performance of the same according to the true intent and meaning thereof, and have always performed and fulfilled the same and all the conditions thereof until the time of the assignment thereof to the said plaintiff, and, since the time of said assignment to the said plaintiff, the said plaintiff has always in all things well and truly performed and fulfilled all the conditions precedent to be performed on the part of his assignors and on his part."

The plaintiff also avers by that count that a copy of the contract of March 15, 1899, is annexed to the declaration and made a part thereof. By reference to the last paragraph of the contract we find that the agreement was that the contractor "shall not be entitled to payment or receive payment for any portion of the aforesaid work or materials until the same shall be fully completed in the manner set forth in this agreement, and each and every one of the stipulations hereinbefore mentioned are complied with, and such completion duly certified by the engineer of said commission, whereupon the party of the first part (that is, the defendant) shall, within thirty days from the time of the completion and acceptance of the work, pay to the party of the second part (that is, the plaintiff) the whole of the moneys accruing under this agreement excepting such sum or sums as may be lawfully retained under any of the provisions hereinbefore contained for that purpose." The defendant's fourth plea avers "that the condition precedent to recovery in this action of a final certificate of the engineer of this defendant, as provided for in the agreement of March 15, 1899, set forth in said court, has not been complied with, and of this the said defendant puts itself upon the country," etc.

Section 118 of the New Jersey Practice Act (Acts April 14, 1903 [P. L. p. 570]) provides that:

"Either party to an action may aver the performance of conditions precedent generally; and the opposite party shall not deny such averment generally, but shall specify in his pleading the condition precedent, the performance of which he intends to contest."

It will be observed that the plaintiff has averred, by the first count of his declaration, not the performance of all conditions precedent to his right of recovery, but only of those conditions precedent which he and his assignors were bound to perform. Section 118 of the New Jersey practice act authorizes a plaintiff to aver generally the performance of all conditions precedent to his right of recovery, by whomsoever those conditions are to be performed. *Dimick v. Metropolitan Life Ins. Co.*, 67 N. J. Law, 373, 374, 51 Atl. 692. When such an averment is made, a plea that specifically denies the performance of one of those conditions properly concludes to the country. *Deweese v. Manhattan Ins. Co.*, 34 N. J. Law, 253. Notwithstanding the defendant's fourth plea concludes to the country, the plaintiff has filed a replication to it by which he avers that the performance of the condition mentioned in the plea was waived by the defendant, and he concludes his replication with a verification. Of course, such a replication is irregular. A plaintiff cannot file a replication, concluding with a verification, to a plea concluding to the country. Besides, if a defendant waives the performance of a condition precedent, that fact should be averred

in the declaration. A plaintiff cannot be allowed to aver in his declaration the full performance of conditions precedent, and then, when confronted with a special plea that a particular condition precedent has not been performed, reply by saying that the performance of that particular condition was waived. The replication to the fourth plea must therefore be stricken out as irregular and defective.

But I cannot dismiss this branch of the case without calling attention to the fact that the plaintiff has not averred the performance of the condition which the defendant's fourth plea denies. That plea denies that the provision of the contract that the engineer should give a certificate that the work had been completed according to the terms of the contract was complied with. By the contract it appears that the engineer was not the engineer of the plaintiff, but of the defendant. The plea itself so declares. The giving of the certificate, therefore, was not an act to be performed by the plaintiff or any of his agents. It follows that, as the plaintiff has averred the performance of those conditions only which he and his assignors were bound to perform, and as the plea does not deny the performance of any such condition, but sets up new matter, the plea improperly concludes to the country. There is therefore an irregularity in the pleadings that reaches back of the replication. Although this irregularity cannot be dealt with on the present motion, it is suggested to the counsel for their consideration to the end that the pleadings may be put into proper shape for trial of the action.

UNITED STATES v. MAX MAYER & CO.

(Circuit Court, S. D. New York. November 6, 1908.)

No. 5,181.

CUSTOMS DUTIES (§ 37*)—GLOVES—MEASUREMENT—"EXTREME LENGTH."

In Tariff Act July 24, 1897, c. 11, § 1, Schedule N, par. 439, 30 Stat. 192 (U. S. Comp. St. 1901, p. 1676), it is prescribed that in determining the length of gloves for duty purposes "the lengths stated in each case" shall be "the extreme length when stretched to their full extent." *Held*, that slight accidental excesses over the lengths mentioned in the law may be disregarded.

[Ed. Note.—For other cases, see Customs Duties, Dec. Dig. § 37.*]

In the decision below the Board of General Appraisers reversed the decision by the collector of customs at the port of New York, holding that he had proceeded illegally in the ascertainment of the dutiable length of imported gloves. So far as pertinent, the opinion of the Board reads as follows:

McCLELLAND, General Appraiser. * * * It appears from the record that various lots of gloves on the invoices covered by the protests, described as "14-inch" and "17-inch" gloves, were found to be respectively over these measurements, and so returned by the appraiser. The collector, following the returns by the appraiser, assessed duties accordingly, and the importers complain that, in so far as the amounts of duty assessed were increased by being based on measurements greater than 14 inches and 17 inches, the assessments were erroneous. The three paragraphs of the existing tariff act which reg-

*For other cases see same topic & § NUMBER in Dec. & Am. Digs. 1907 to date, & Rep'r Indexes

ulate the assessment of duty according to length on the gloves involved are as follows (Tariff Act July 24, 1897, c. 11, § 1, Schedule N, pars. 439, 441, 30 Stat. 192 [U. S. Comp. St. 1901, pp. 1676, 1677]):

"439. Gloves made wholly or in part of leather, whether wholly or partly manufactured, shall pay duty at the following rates, the length stated in each case being the extreme length when stretched to their full extent, namely:

"440. Women's or children's 'glace' finish, schmaschen (of sheep origin) not over fourteen inches in length, one dollar and seventy-five cents per dozen pairs; over fourteen inches and not over seventeen inches in length, two dollars and twenty-five cents per dozen pairs; over seventeen inches in length, two dollars and seventy-five cents per dozen pairs; men's 'glace' finish, schmaschen (sheep) three dollars per dozen pairs.

"441. Women's or children's 'glace' finish, lamb or sheep, not over fourteen inches in length, two dollars and fifty cents per dozen pairs; over fourteen and not over seventeen inches in length, three dollars and fifty cents per dozen pairs; over seventeen inches in length, four dollars and fifty cents per dozen pairs; men's 'glace' finish, lamb or sheep, four dollars per dozen pairs."

It is shown by the evidence that the 14-inch gloves returned as being over that length exceed 14 inches by from one-eighth to one-half an inch, and that the 17-inch gloves returned as being over that length range from $17\frac{3}{8}$ to $17\frac{3}{16}$ inches. It is contended on behalf of the government that the language of paragraph 439 must be strictly construed, and that the mere fact that the gloves exceed the limitations or measurements mentioned in paragraphs 440 and 441, regardless of the insignificance of such excesses, makes them liable to the duties assessed; but we think that view is unreasonable. We cannot believe that Congress intended that such a narrow, hairsplitting construction should be placed upon these conditions, especially in the light of trade experience as shown by the uniform testimony of all the witnesses that there could result no possible advantage to either the seller or buyer of gloves from such infinitesimal excesses of measurement. The witnesses were united in saying that the gloves in question would be bought and sold as of 14 or 17 inches, and that no consideration whatever would be given to the apparent excesses of measurement. This fact is strengthened by the established custom of the domestic glove trade, which shows that gloves are not sold by length, but by the number of buttons, and under this usage a 14-inch glove is known as a 2-clasp or 6-button, a 17-inch glove as an 8 to 10 button, a 20-inch as a 12-button, and a 23-inch glove as a 16-button glove; and that it requires an excess of 1 inch over each of these measurements to admit of an additional button. The leather from which the gloves are made is of course flexible; and it is reasonable to assume, we think, that a glove cut therefrom to either the 14 or 17 inch length might easily be stretched one-half inch in excess of such measurement.

It would, in our opinion, work manifest injustice to the importer if the government's contention were upheld, and we therefore sustain the claim * * * that the gloves specified in the schedule marked "A" under item, case, and protest numbers are of the lengths indicated in said schedule and subject to duty accordingly.

J. Osgood Nichols, Asst. U. S. Atty.
Everit Brown, for the importers.

MARTIN, District Judge (orally). This is an appeal by the government from decisions of the Board of General Appraisers relative to the assessment of duty on certain gloves under paragraphs 439, 440, and 441 of the tariff act of 1897 (Act July 24, 1897, § 1, 30 Stat. 192 [U. S. Comp. St. 1901, pp. 1676, 1677]).

It is contended by the government that these gloves measured $14\frac{1}{8}$ to $14\frac{1}{2}$ inches and $17\frac{1}{8}$ to $17\frac{3}{16}$ inches. It is claimed that the duty should be increased 50 cents per dozen for the fractional excess of

measurement, and that the language of paragraph 439 must be strictly construed. The Board of Appraisers state:

"We cannot believe that Congress intended that such a narrow, hairsplitting construction should be placed upon these provisions, especially in the light of trade experience as shown by the uniform testimony of all the witnesses that there could result no possible advantage to either the seller or buyer of gloves from such infinitesimal excesses of measurement."

From a careful examination of the record it appears that there was no possible advantage to either the seller or the buyer of the gloves in question from this "excess of measurement." Neither is the element of protection affected thereby. It is plainly evident from the samples that were before me that variation of an eighth or a quarter of an inch may be accounted for by the manner of making the glove, in the amount taken out in the stitching of seams; another variation may be accounted for in the difference in degree of elasticity of the material used; and still another variation by the amount of force employed in stretching the glove for measurement. The temperature at the time of the measurement of the glove may also vary it somewhat. In view of the fact that a glove that measures exactly 14 inches or an eighth or a fraction of an inch below sells for the same price as that of a glove a fraction of an inch longer, it would be unjust to assess a duty of 50 cents per dozen pairs more for the one than the other. It seems to me an unwise construction of the statute that works injustice. I concur with the decision of the Board of General Appraisers.

Decision affirmed.

E. C. HAZARD & CO. v. UNITED STATES.

(Circuit Court, S. D. New York. November 9, 1908.)

No. 4,921.

CUSTOMS DUTIES (§ 43*)—CLASSIFICATION—COFFEE EXTRACT—"ARTICLE USED AS COFFEE"—"SUBSTITUTE FOR COFFEE"—"UNENUMERATED MANUFACTURED ARTICLE."

A liquid extract of the coffee bean held not to be dutiable under Tariff Act July 24, 1897, c. 11, § 1, Schedule G, par. 283, 30 Stat. 172 (U. S. Comp. St. 1901, p. 1652), relating to "articles used as coffee, or as substitutes for coffee," but under section 6, 30 Stat. 205 (U. S. Comp. St. 1901, p. 1693), as an unenumerated manufactured article.

[Ed. Note.—For other cases, see Customs Duties, Dec. Dig. § 43.*]

On Application for Review of a Decision by the Board of United States General Appraisers.

The opinion below reads in part as follows:

HAY, General Appraiser. The appraiser reports that the merchandise consists of a liquid extract of the coffee bean, commercially known as "essence of coffee," and not as "coffee" or "coffee substitute." The sample bottle submitted at the hearing is labeled "Concentrated Essence of Turkey Coffee," with directions for adding 1 to 2 teaspoonfuls of the essence, sugar, and milk or cream, and boiling water, to make a cup of coffee. The witnesses introduced

*For other cases see same topic & § NUMBER in Dec. & Am. Digs. 1907 to date, & Rep'r Indexes

by the importer at the hearing testified that they had no knowledge of the ingredients composing the commodity in question, but that it was used as a beverage, and one of them expressed the belief that it was composed of coffee and chicory.

With no other testimony before us than was presented, we could not sustain either of the importer's contentions. It is certainly not coffee, although coffee doubtless enters very largely into its composition, and in fact it may be manufactured wholly from coffee. It cannot, in our judgment, come under paragraph 283 of Act July 24, 1897, c. 11, § 1, Schedule G, par. 283, 30 Stat. 172 (U. S. Comp. St. 1901, p. 1652), as it is apparent from the reading of that paragraph that it is intended to cover commodities that are not coffee and yet used as a substitute for it. No other paragraph of the law under which the commodity could be classified has been called to our attention, and the classification made by the collector is apparently a correct one. The commodity is not an unmanufactured article, and, if it is assessable under section 6, 30 Stat. 205, c. 11 (U. S. Comp. St. 1901, p. 1693), it is of course at the higher rate. The protest is therefore overruled.

Walden & Webster (Henry, J. Webster, of counsel), for importers.
J. Osgood Nichols, Asst. U. S. Atty.

MARTIN, District Judge (orally). The merchandise in question is described by the local appraiser as a "liquid extract of the coffee bean." What facts he had before him upon which to base this conclusion does not appear. The merchandise was assessed for duty by the collector of customs at the rate of 20 per cent. ad valorem under section 6 of the tariff act of July 24, 1897, c. 11, 30 Stat. 205 (U. S. Comp. St. 1901, p. 1693), which provides for all unenumerated manufactured articles. The protest sets up various claims; but upon the argument counsel for the importer, while not waiving his claim to free entry under paragraph 529, § 2, Free List, 30 Stat. 197 (U. S. Comp. St. 1901, p. 1682), stated, using his own language, "my contention is that it [the merchandise in question herein] is covered by paragraph 283 [Schedule G, 30 Stat. 172 (U. S. Comp. St. 1901, p. 1652)], either as an 'article used as coffee or as a substitute for coffee,' directly or by similitude."

Two witnesses only testified before the Board of Appraisers. No additional evidence was introduced in this court. Neither of the witnesses was able to state what the article consisted of. The board finds that it is a manufactured article, and not specially provided for in any of the paragraphs of the act, and therefore assessable under section 6. They found from the meager evidence before them that the article was not coffee, and further, that it cannot "come under paragraph 283, as it is apparent from the reading of that paragraph that it is intended to cover commodities that are not coffee, and yet used as a substitute for it." The importer was content to bring this case before the court, resting upon that meager evidence. Apparently Congress intended by paragraph 283 to provide for a cheap article as a substitute for coffee. It does not affirmatively appear that the article here in question is a cheap commodity. It was within the knowledge of the importer to give evidence of the cost of the product, but he is silent upon that subject. As the case stands, I cannot assume that this article comes within the classification of articles that Congress intended should be included in paragraph 283.

In my opinion, there are not sufficient facts presented to justify the court in disturbing the findings or overruling the conclusions of the board. Their decision is affirmed.

DENUNZIO FRUIT CO. v. UNITED STATES.

(Circuit Court, W. D. Kentucky. June 4, 1908.)

No. 7,148 (2,005).

CUSTOMS DUTIES (§ 78*)—ROTTEN FRUIT—EVIDENCE—PARTIAL EXAMINATION.

Evidence as to the amount of decay in imported rotten fruit consisted merely of proof as to the percentage of decay in 5 per cent. of the packages imported. *Held* that, as the exact facts relative to the entire importation might have been ascertained, the evidence as to the packages examined should not be extended to the packages not examined.

[Ed. Note.—For other cases, see Customs Duties, Dec. Dig. § 78.*]

On Application for Review of a Decision by the Board of United States General Appraisers.

The decision below, which is reported as G. A. 6,713 (T. D. 28,712), sustained in part the petitioners' protests against the assessment of duty by the surveyor of customs at the port of Louisville. In these proceedings the importers contend for a greater amount of relief than that granted by the board in the decision under review.

J. L. Richardson, for importers.

George Du Relle (John A. Kemp, Solicitor of Customs, and Thomas M. Lane, Ass't Treasury Counsel, on the brief), for the United States.

EVANS, District Judge. The Joseph Denunzio Fruit Company imported into this country three lots of lemons—one of 300 boxes by the Carpathia, one of 350 boxes by the Louisiana, and one of 390 boxes by the Dora Baltea. Each importation arrived at the port of New York in good condition; but the importer says in its protest in respect to each shipment that it "was delayed at the port on arrival by reason of some strike disturbance, and it was by reason of this delay that the fruit decayed." Each shipment was transported to the port of Louisville, Ky., in bond. Upon its arrival here the duties were liquidated by the surveyor of the port, and various percentages for damages to the fruit were allowed. Upon an appeal to the Board of General Appraisers, these percentages were changed, and the questions involved have been brought here.

The Board of General Appraisers took the view that as 10 per cent. of the shipment was never in fact examined by the customs officers or the importers, nor a percentage estimated upon such examination, there was no sufficient proof to support the allowance of damages to the fruit made by the surveyor, and consequently ordered a reliquidation upon the basis of the examination which had actually been made—that examination not having extended to more

*For other cases see same topic & § NUMBER in Dec. & Am. Digs. 1907 to date, & Rep'r Indexes

than 5 per cent. of the importations. The court is of opinion that this was a correct ruling and should be affirmed, unless the testimony afterwards taken presents a different case. In his brief, the counsel for the government contends that the amount of duties became a fixed liability upon the arrival of the fruit in the port of New York, at which time it seems to have been sound. But neither the Board of General Appraisers nor the surveyor at Louisville seems to have proceeded upon that theory of the law; for, notwithstanding the statements quoted from the protests of the importer, the damages were estimated at Louisville, and without reference to the condition of the fruit when it arrived at New York. It is not necessary that we shall undertake to determine which was correct; but, assuming, as we must, that the fruit was sound when it came into the port of New York—that is to say, when the importation was probably complete—the burden was upon the importer at least to show how much of the fruit was in a damaged condition when it reached Louisville. The Board of General Appraisers proceeded upon fairly satisfactory evidence in the allowances it made; but even when we have the additional testimony before us, we are still left to conjecture and to guesswork as to any damages beyond those allowed by the board. That there was some additional damage we think is probable; but conjecture is hardly a sufficient basis for judicial action in a case where it is obvious that the exact facts might have been clearly ascertained if the importer had taken pains upon the arrival of the fruit to ascertain precisely what the damages were, by actual examination and reboxing in the presence of the customs inspector at Louisville. This might have required some labor and some going into details, but would have made clear what is now taken as a matter of conjecture. Nothing not within observation would “have been taken for granted,” as witness Miller expressed it.

We cannot satisfactorily ascertain from the testimony, nor can we say exactly nor even approximately, what damages there were to the fruit beyond what was estimated by the Board of Appraisers; and consequently we find no sufficient ground for reversing a ruling which otherwise appears to be correct. That ruling will therefore be affirmed.

PARK & TILFORD v. UNITED STATES.

(Circuit Court, S. D. New York. November 5, 1908.)

No. 5,263.

**1. CUSTOMS DUTIES (§ 30*)—CLASSIFICATION—“CHUTNEY”—“PRESERVED FRUIT”
—“EDIBLE FRUITS * * * PREPARED.”**

The article commercially known as “chutney,” which consists of various fruits preserved with sugar and spices, is dutiable as “fruits preserved,” under Tariff Act July 24, 1897, c. 11, § 1, Schedule G, par. 263, 30 Stat. 171 (U. S. Comp. St. 1901, p. 1651), rather than as “edible fruits * * * prepared,” under paragraph 262, 30 Stat. 171 (U. S. Comp. St. 1901, p. 1651).

[Ed. Note.—For other cases, see Customs Duties, Dec. Dig. § 30.*]

*For other cases see same topic & § NUMBER in Dec. & Am. Digs. 1907 to date, & Rep'r Indexes

2. CUSTOMS DUTIES (§ 30*)—COMMERCIAL DESIGNATION—"FRUITS PRESERVED."

The article commercially known as "chutney" does not, by reason of such designation, cease to be "fruits preserved," within the meaning of Tariff Act July 24, 1897, c. 11, § 1, Schedule G, par. 263, 30 Stat. 171 (U. S. Comp. St. 1901, p. 1651).

[Ed. Note.—For other cases, see Customs Duties, Dec. Dig. § 30.*]

On Application for Review of a Decision of the Board of United States General Appraisers.

The Board of General Appraisers affirmed the assessment of duty by the collector of customs at the port of New York. The Board's opinion is as follows:

WAITE, General Appraiser. The merchandise in question consists of various fruits preserved with sugar and spices, commercially known as "chutney." In Abstract 13,660 (T. D. 27,745), following G. A. 4,979 (T. D. 23,233), the Board passed upon similar goods, holding them to be properly dutiable as assessed in this case, at 1 cent per pound and 35 per cent. ad valorem, under the provision in paragraph 263, Tariff Act of 1897, Act July 24, 1897, c. 11, § 1, 30 Stat. 171 (U. S. Comp. St. 1901, p. 1651), for "fruits preserved in sugar, molasses, spirits, or in their own juices." Appeal was taken from the Board's decision to the Circuit Court for the Southern District of New York; the importers claiming that the chutney was dutiable under paragraph 241, 30 Stat. 170 (U. S. Comp. St. 1901, p. 1649), relating to "vegetables, prepared or preserved, including pickles and sauces of all kinds." That appeal has recently been abandoned by the importers, leaving the Board's decision to govern.

In this case now before us the importers make the claim that duty should have been assessed under section 6, or under the provision in paragraph 262 for "edible fruits, prepared in any manner, not specially provided for." In support of this latter contention the importers argue that the goods, being commercially known as "chutney," are therefore not commercially known as preserved fruits, or as preserves, and hence not within the purview of paragraph 263, as that paragraph has been construed by the United States Circuit Court of Appeals in the case of *Causse Manufacturing Co. v. U. S.*, 151 Fed. 4, 80 C. C. A. 461, T. D. 27,751. In that case it was stated that paragraph 263 "is intended to apply to fruits which have been 'preserved'—that is, treated so as to become a preserve or comfit, and not to such as merely remain temporarily in their natural juices." In G. A. 6,726 (T. D. 28,799) the Board has recently discussed the *Causse Case*, reaching the conclusion that the logical construction of that decision warrants attaching to paragraph 263 a comprehensiveness broad enough to include the very class of products of which this chutney is typical.

Following the reasoning laid down in the decision last cited, this protest is overruled, and the collector's assessment is affirmed.

B. A. Levett, for importers.

D. Frank Lloyd, Asst. U. S. Atty.

MARTIN, District Judge (orally). The merchandise in question consists of various fruits preserved with sugar and spices, commercially known as "chutney." The return for duty was made under paragraph 263 of the tariff act of 1897 (Act July 24, 1897, c. 11, § 1, Schedule G, 30 Stat. 171 [U. S. Comp. St. 1901, p. 1651]). That paragraph provides:

"Comfits, sweetmeats, and fruits preserved in sugar, molasses, spirits, or in their own juices, not specially provided for in this act, one cent per pound and thirty-five per centum ad valorem. * * *"

*For other cases see same topic & § NUMBER in Dec. & Am. Digs. 1907 to date, & Rep'r Indexes

It is contended by the importer that the duty should have been assessed either at 2 cents per pound under paragraph 262 for "edible fruits * * * prepared in any manner, not specially provided for," or, if not so dutiable, then at 20 per cent. ad valorem under section 6 of said act (30 Stat. 265 [U. S. Comp. St. 1901, p. 1693]) as "unenumerated manufactured articles." No question is made but what this merchandise consists of fruits preserved with sugar and spirits. I cannot conceive that the word "spices" changes its classification at all. In fact, it was not so claimed on the hearing by counsel for the importer.

It is claimed that the finding by the appraisers that this article is commercially known as "chutney" takes it out of the provisions of paragraph 263 and is not to be regarded as a preserved fruit. The article seems to be preserved fruit just the same, whatever name may be given to it by the party who prepared it. Cases cited by counsel for the importer relative to constructions that may be given to certain schedules, as affected by commercial usage or how the same may be commercially known, do not, in my opinion, apply to the case at bar. It seems to me that paragraph 263 squarely describes the merchandise in question.

The decision of the Board of General Appraisers is affirmed.

UNITED STATES v. PASSAVANT & CO.

(Circuit Court, S. D. New York. May 12, 1908.)

No. 4,089.

CUSTOMS DUTIES (§ 35*)—CLASSIFICATION—"PANNE VELVET"—PLUSH.

So-called "panne velvet" is dutiable as "plush," and not as "velvets," under Tariff Act July 24, 1897, c. 11, § 1, Schedule L, par. 386, 30 Stat. 186 (U. S. Comp. St. 1901, p. 1669).

[Ed. Note.—For other cases, see Customs Duties, Dec. Dig. § 35.*]

On Application for Review of a Decision by the Board of United States General Appraisers.

In the decision below, which is reported as G. A. 6,136 (T. D. 26,668), the Board of General Appraisers, one member dissenting, held that importations of so-called "panne velvet" had been improperly classified by the collector of customs at the port of New York as "velvets," under Tariff Act July 24, 1897, c. 11, § 1, Schedule L, par. 386, 30 Stat. 186 (U. S. Comp. St. 1901, p. 1669), and that the material in question should have been assessed at the rate provided in the same paragraph for "plush." The ground of this determination was the fact that panne velvet was shown by the evidence to be commercially known as "plushes."

D. Frank Lloyd, Asst. U. S. Atty.

Brooks & Brooks (Frederick W. Brooks, of counsel), for importers.

PLATT, District Judge. Affirmed, on the decision of Judge Hough in U. S. v. Silberstein (C. C.) 153 Fed. 965.

*For other cases see same topic & § NUMBER in Dec. & Am. Digs. 1907 to date, & Rep'r Indexes

TRODICK v. NORTHERN PAC. RY. CO. et al.

(Circuit Court of Appeals, Ninth Circuit. November 5, 1908.)

No. 1,563.

1. PUBLIC LANDS (§ 79*)—RAILROAD GRANT—LANDS EXCEPTED—"CLAIM OF RIGHT."

Unsurveyed land within the primary limits of the grant to the Northern Pacific Railroad Company by Act July 2, 1864 (13 Stat. 365, c. 217), as fixed by the definite location of the road, but which at the time of the filing of the map of such location was actually occupied by a settler, who had made improvements thereon with the bona fide intention of acquiring title thereto under the homestead law when it should be surveyed, was subject to a "claim or right" within the meaning of the act, and did not pass under the grant.

[Ed. Note.—For other cases, see Public Lands, Cent. Dig. §§ 244, 245; Dec. Dig. § 79.*

For other definitions, see Words and Phrases, vol. 2, pp. 1213-1214.]

2. PUBLIC LANDS (§ 35*)—HOMESTEAD SETTLERS ON UNSURVEYED LAND—RIGHT TO ACQUIRE TITLE.

Under Act May 14, 1880, c. 89, § 3, 21 Stat. 140 (U. S. Comp. St. 1901, p. 1393), which extends to homestead settlers on unsurveyed public lands the same right as pre-emption settlers to perfect their right by application made within three months after the filing of the plat of survey, the failure to file within such time does not affect the settler's right, except as against another claimant who has acquired or initiated some right before the application is in fact made.

[Ed. Note.—For other cases, see Public Lands, Cent. Dig. § 73; Dec. Dig. § 35.*]

3. PUBLIC LANDS (§ 35*)—RIGHT OF HOMESTEAD SETTLER—PURCHASE OF IMPROVEMENTS.

The fact that a settler, who is actually residing on public land with the bona fide intention of acquiring title thereto under the homestead law, purchased his improvements from a prior settler, does not affect his right to so acquire the land.

[Ed. Note.—For other cases, see Public Lands, Dec. Dig. § 35.*

Rights acquired by homestead settlements and entries, see note to McCune v. Essig, 59 C. C. A. 434.]

Morrow, Circuit Judge, dissenting.

Appeal from the Circuit Court of the United States for the District of Montana.

Walsh & Nolan, for appellant.

Massena Bullard, William Wallace, Jr., and Charles Donnelly, for appellees.

Before GILBERT, ROSS, and MORROW, Circuit Judges.

ROSS, Circuit Judge. This suit was brought by the appellant in the court below to obtain a decree requiring the conveyance to him of the title to the S. E. $\frac{1}{4}$ of section 35, township 15 N., range 4 W., Helena land district, of the state of Montana, conveyed by the government patent issued January 10, 1903, to the appellee, the Northern Pacific Railway Company, as the successor in interest of the Northern Pacific Railroad Company, the beneficiary of the grant made to it by

*For other cases see same topic & § NUMBER in Dec. & Am. Digs. 1907 to date, & Rep'r Indexes

Act Cong. July 2, 1864, c. 217, 13 Stat. 365. The case shows that the tract in controversy is within the primary limits of that grant to the Northern Pacific Railroad Company, the map of the definite location of the line of which road was filed July 6, 1882. At that time the land in controversy was unsurveyed. It was not surveyed until the year 1891; the plats of the survey thereof being filed in the local land office on the 10th day of August of that year. September 21, 1892, it was listed to the railroad company. The record further shows that one Martin Lamlein established his residence on this tract of unsurveyed government land with his family in 1877, with the bona fide intention of acquiring title thereto under the homestead laws, made improvements thereon of the value of about \$1,000, and continued to reside upon the land until his death, during the year 1891. In holding that such settlement did not except the land from the operation of the grant to the railroad company, the Commissioner of the General Land Office expressly found the facts to be as above stated, and further, in communicating his decision to the local land office, said:

"It is undoubtedly true that the land was occupied by Mr. Lamlein when the right of the company attached, and that he was qualified to make entry of the same and settled there with the intention of doing so, as the circumstances indicate. Had he lived until the plat of survey was filed in your office, he or his wife would, without doubt, have been allowed to perfect the claim by them initiated prior to July 6, 1882. Since Mr. Lamlein had no claim of record, and the claim of Trodick had its inception subsequent to the definite location of the road, it must be held that the land inured to the grant. *N. P. R. Co. v. Colburn*, 164 U. S. 387, 17 Sup. Ct. 98, 41 L. Ed. 479."

The case further shows that just before his death Lamlein sold the improvements to the appellant, Trodick, who thereupon took possession of the land with the intention of acquiring the title thereto from the government, but that Trodick did not apply to enter it as a homestead until January 10, 1896, which application on his part, being refused by the local land office, resulted in an appeal to the Commissioner of the General Land Office, and in his adverse decision already referred to. The court below, in dismissing the bill, as it did, referred to Act Cong. May 14, 1880, c. 89, 21 Stat. 140 (U. S. Comp. St. 1901, p. 1392), by which the settler upon public unsurveyed lands, with the intention to claim under the homestead law, was allowed the same time to file his homestead application and to perfect his original entry in the United States land office, as was allowed a pre-emption settler to put his claim on record, and by which it was provided that such homesteader's right should relate back to the date of his settlement, the same as if he settled under the pre-emption laws. Said the court below:

"This would have given Lamlein, had he lived, 90 days after the filing of the township plat (August 10, 1891), within which time he was obliged to put his application for entry on file, so as to become of record. He had sold, however, to Trodick in 1889, so that the very best possible position that may be conceded to Trodick is such as Lamlein could have occupied, if he had not sold, and had lived until after the plats of survey were filed. But, even upon such a concession, it became his duty, as it would have been Lamlein's duty, to file his application for homestead within 90 days after the filing of the township plat in 1891. He failed to do so, though, and by his omission he lost his rights to enter the land under the homestead laws. The case is there-

fore one where, the occupant having failed to take the necessary steps to file his application until long after the survey and filing, the land passed to the railroad grant, and no claim of ownership can be made at this time. As I read the cases of *Nelson v. Northern Pacific Ry. Co.*, 188 U. S. 109, 23 Sup. Ct. 302, 47 L. Ed. 406 and *Oregon & California R. R. Company v. United States*, 189 U. S. 103, 23 Sup. Ct. 615, 47 L. Ed. 726, and the cases therein cited, they sustain these views."

We are unable to agree with the trial court in this respect. The land in question being within the primary limits of the railroad grant, whether or not the title thereto passed to that company depended upon the status of the land at the time of the filing of the map of the definite location of the road, which was July 6, 1882. This is the well-established law upon the subject, as is shown by the cases referred to in *Nelson v. Northern Pacific Ry. Co.*, 188 U. S., from and including page 116 to and including page 132, 23 Sup. Ct. 302, 47 L. Ed. 406. The case of *Nelson v. Northern Pacific Ry. Co.* is, in our opinion, precisely similar to the case we have here. The land grant act is the same in both cases. In both the land in controversy fell within the primary limits of that grant, was unsurveyed at the time of the filing of the map of definite location of the road, and there *Nelson*, as *Lamlein* here, was on that day in possession of the land, with his improvements, having years before entered into its possession with a bona fide intention of acquiring title thereto under the homestead laws. In the *Nelson* Case the Supreme Court distinctly adjudged that the Northern Pacific Railroad Company acquired no vested interest to any land under its grant of July 2, 1864, prior to the filing of the map of the definite location of its road, and that all lands which were then "occupied by homestead settlers" with the bona fide intention to acquire the same under the homestead laws were expressly excluded therefrom. 188 U. S. 116, 23 Sup. Ct. 304, 47 L. Ed. 406, and cases there cited. On page 133 of 188 U. S., page 311 of 23 Sup. Ct. (47 L. Ed. 406), in its opinion, the court said:

"*Nelson's* occupancy occurred after the passage of the act of 1880 [that is to say, Act May 14, 1880, c. 89, 21 Stat. 140 (U. S. Comp. St. 1901, p. 1392), already referred to]. While that act did not apply to a railroad company which had acquired the legal title by the definite location of its road, it distinctly recognized the right prior to such time to settle upon the public lands, whether surveyed or unsurveyed, with the intention of claiming the same under the homestead laws. In occupying the land here in dispute *Nelson* did not infringe upon any vested right of the railroad company; for there had not been, at the date of such occupancy in 1881, any definite location of the line of the railroad, and the land so occupied, with other lands embraced by the map of general route, constituted only a 'float'—the company having, at most, only an inchoate interest in them, a right to acquire them, if, at the time of definite location, it was not 'occupied by homestead settlers' nor incumbered with 'other claims or rights.' The withdrawal merely from 'sale or entry' in 1873, based only on a map of the general route of the road, did not identify any specific sections, was not expressly directed or required by the act of 1864, was made only out of abundant caution and in accordance with a practice in the land department, and did not and could not affect any rights given to homestead occupants by Congress in the acts of 1864 and 1880. Besides, the order made in 1873 to withhold from sale or entry all the odd-numbered sections falling within the limits of the general route was without practical value so far as the land in dispute was concerned; for such land had not been surveyed, and there could not have been any sale or entry of unsurveyed lands. At any rate, the order of withdrawal directing the local land office to withhold

from 'sale or entry' the odd-numbered sections within the limits of the general route could not prevent the occupancy of one of those sections prior to definite location by one who in good faith intended to claim the benefit of the homestead law; and this, because such right of occupancy was distinctly recognized by the act of 1864. But, if this were not so, the act of 1880, in its application to public lands which have not become already vested in some company or person, must be held to have so modified the order of withdrawal based merely on general route that such order would not affect any occupancy or settlement made in good faith, as in the case of Nelson, after the passage of that act, and prior to definite location. This conclusion cannot be doubted, because the act of 1880 made no exception of public lands covered by orders of withdrawal from sale or entry based merely on general route, and because, also, public lands, which had not become vested in the railroad company by the definite location of its line, were subject to the power of Congress."

The circumstance that in the Nelson Case Nelson filed upon the land claimed by him as soon as it was surveyed and the plat thereof returned to the land office was a circumstance which does not exist in the present one, for the reason that the land was still unsurveyed at the time of Lamlein's death, which circumstance, however, was not at all vital to the decision in the case of Nelson v. Northern Pacific Railway Company, which, as has been seen, was based solely upon the fact that at the time of the filing of the map of definite location of the road the land in question was in the possession of and improved by Nelson, with the bona fide intention on his part to acquire title thereto under the homestead laws.

The Commissioner of the General Land Office, as has been seen, based his ruling that the land here in controversy inured to the railroad company under its grant, upon the decision in Northern Pacific Railroad Co. v. Colburn, 164 U. S. 387, 17 Sup. Ct. 98, 41 L. Ed. 479, which case is clearly distinguishable from the present one by the fact that in that case the land was surveyed prior to the filing of the map of definite location by the railroad company, and, notwithstanding such survey, the occupant had not manifested the good faith of his occupation by entering or attempting to enter the land under the law. And this clear distinction was distinctly pointed out by the Supreme Court in the case of Nelson v. Northern Pacific Railway Company, at page 132 of 188 U. S., page 311 of 23 Sup. Ct. (47 L. Ed. 406), in its opinion, where it said:

"Nor is there any conflict between the decision now rendered and Northern Pacific Railroad v. Colburn, 164 U. S. 383, 17 Sup. Ct. 98, 41 L. Ed. 479; for, as appears from the opinion and record in that case, the land there claimed to have been occupied by a homestead settler at the date of definite location was surveyed public land, and the good faith of the occupation was not manifested by an entry, or an attempt at entry, at any time in the local land office. It was held that the inchoate right of the homesteader must be initiated by a filing in the land office. In the present case, as we have seen, the land occupied was unsurveyed, and at the time of such occupancy, the land being unsurveyed, there could not then have been any filing or entry in the land office."

See, also, in the same connection, Northern Pacific Ry. Co. v. McCormick, 94 Fed. 932, 36 C. C. A. 560.

For the reasons stated, we think it clear that the piece of land here in controversy was not embraced by the railroad company's grant, and that the patent was issued by the government to the company because

of the erroneous view of the law taken by the Commissioner of the Land Office.

The only other question requiring special notice is whether the appellant is entitled to a conveyance of the title thus passed by the patent. The record shows that, during his last illness in 1891, Lamlein sold his improvements upon the land to Trodick for a valuable consideration, and that the latter thereupon went into possession of the premises and continued to reside there, but did not apply to enter the land as a homestead until January 10, 1896, which application the land office refused solely because it held, as has been seen, that the land passed to the railroad company by virtue of its grant. And the court below based its ruling against appellant upon the ground that he did not file his application under the homestead law within 90 days after the filing of the township plat of August 10, 1891. But such delay on the part of the homesteader did not forfeit his right, except as against some one who had himself acquired or initiated a right. As has been seen, the requirement in respect to filing an application within 90 days after the return of the plat is, by the statute already referred to, applicable alike to pre-emption and homestead claims. In the case of *Landsdale v. Daniels*, 100 U. S. 113, 25 L. Ed. 587, each party claimed under Act March 3, 1853, c. 143, 10 Stat. 244, from which it appeared that unsurveyed as well as surveyed lands not exempted by the same act were subject to the pre-emption laws, with all the exceptions, conditions, and limitations expressed in such, unless otherwise expressed or provided, and, among other things, that where unsurveyed lands were claimed the usual notice of such claim should be filed within three months after the return of the plats of surveys to the land office. The land there in controversy being unsurveyed, the plaintiff made entry and settlement thereof November 1, 1853, and the defendant made entry and settlement on the same quarter section February 22, 1854. The precise date of the survey did not appear; but it did appear that the plats of the survey were returned into the local land office April 26, 1856, prior to which time, to wit, February 20, 1856, the defendant had filed his notice of claim or declaratory statement. Congress had provided that, where unsurveyed lands in the state in which the land in controversy was situated were claimed by pre-emption, the usual notice of such claim should be filed within three months after the return of plats of surveys to the land officer, and proof and payment should be made prior to the day appointed by the President's proclamation for the commencement of the sale of such lands. Declaratory statements under the original act might be made within three months after the return of the plats of surveys to the local land offices, which was effectual as a step to secure the right, if it was within one year from the passage of the act, which last provision was amended by a subsequent act and extended to settlements made prior to and within two years after the passage of the amendatory act (Act June 2, 1862, c. 90, 12 Stat. 410). The defendant's declaratory statement having been made prior to the return of the plats of surveys, instead of after, as required by the statute, was held by the court to be unauthorized and void. Still the defendant insisted that he was entitled to the patent to the land because the plaintiff did not file his de-

claratory statement until more than two years after the plats of the surveys of the land were returned into the local land offices instead of within three months, as required by the statute. The Supreme Court thus answered that contention:

"Grant that; but it only shows that both parties settled upon the land while it was unsurveyed, and that each was to some extent in fault in filing his declaratory statement; the difference being that the defendant filed his before he had any right to file it under the pre-emption act, which rendered it a nullity, and that the plaintiff did not file the required notice of claim until the time allowed by the amendatory act had expired. Such a notice, if given before the time allowed by law, is a nullity; but the rule is otherwise where it is filed subsequent to the period prescribed by the amendatory act, as in the latter event it is held to be operative and sufficient unless some other person had previously commenced a settlement and given the required notice of claim. *Johnson v. Towsley*, 13 Wall. 72, 91, 20 L. Ed. 485. Tested by that rule, it is clear that the equity of the plaintiff is superior to that of the defendant, as the latter never filed any other notice of claim than that which preceded the return of the plats of survey into the local land offices."

In the case of *Whitney v. Taylor*, 158 U. S. 85, 93, 96, 15 Sup. Ct. 796, 39 L. Ed. 906, the Supreme Court, having considered, among other things, the objection made that a claim made under the act of 1853 was not filed within three months after the return of the plats of surveys to the land offices, said:

"With reference to the second matter, it is true that section 6 of the act of 1853 (10 Stat. 246, c. 145) provides 'that, where unsurveyed lands are claimed by pre-emption, the usual notice of such claim shall be filed within three months after the return of the plats of surveys to the land offices.' But it was held in *Johnson v. Towsley*, supra, that a failure to file within the prescribed time did not vitiate the proceeding, neither could the delay be taken advantage of by one who had acquired no rights prior to the filing. As said in the opinion in that case (page 90 of 13 Wall. [20 L. Ed. 485]): 'If no other party has made a settlement or has given notice of such intention, then no one has been injured by the delay beyond three months, and if at any time after the three months, while the party is still in possession, he makes his declaration, and this is done before any one else has initiated a right of pre-emption by settlement or declaration, we can see no purpose in forbidding him to make his declaration or in making it void when made. And we think that Congress intended to provide for the protection of the first settler by giving him three months to make his declaration, and for all other settlers by saying if this is not done within three months any one else who has settled on it within that time, or at any time before the first settler makes his declaration, shall have the better right.' See, also, *Landsdale v. Daniels*, 100 U. S. 113, 117, 25 L. Ed. 587."

And the court proceeds to quote from the last-mentioned case the portion of the opinion hereinbefore set out.

The case of *Landsdale v. Daniels* also answers an objection made to the validity of the sale by Lamlein to Trodick of his improvements upon the land here in controversy. In *Landsdale v. Daniels* objection was made to the plaintiff's claim to the land on the ground that, instead of erecting a dwelling house on the land claimed by him, he purchased the dwelling house already there, in answer to which the court said:

"His entry and occupancy of the tract are admitted, and the court is of the opinion that it is immaterial whether he built the dwelling house himself, or hired an agent to erect it for him, or whether he purchased it after it was built by another, provided it appears that he was the lawful owner of the

dwelling house, and made the entry and settlement in good faith, and continued to occupy and cultivate the land, as required by the pre-emption laws. Enough appears to show that the dwelling house was there on the land, and that it was owned, possessed, and occupied by the plaintiff as his home more than three months before the defendant entered and attempted to make his settlement."

See, also, *Bishop of Nesqually v. Gibbon*, 158 U. S. 155, 15 Sup. Ct. 779, 39 L. Ed. 931; *Lamb v. Davenport*, 18 Wall. 307, 21 L. Ed. 759.

A suggestion is made on the part of the appellees that the status of the land is to be determined solely by the condition of the records of the land office at the time of the filing of the map of the definite location of the company's road, and that, if it be permissible to prove by parol the fact of settlement, improvement, and residence upon the land in question by the homestead claimant, the railroad company might be deprived of a large part of its grant. Settlement, improvement, and residence are physical facts easily susceptible of proof, and good faith on the part of the claimant is exacted by the land department, as well as by the courts of justice. There is no more danger of their being erroneously decided in cases like the present than in any other case that comes before a court or tribunal depending for its decision upon facts. To a somewhat similar argument the Supreme Court, in the case of *Whitney v. Taylor*, 158 U. S. 95, 96, 15 Sup. Ct. 800, 801, 39 L. Ed. 906, said:

"Counsel urges that, inasmuch as the latter [a declaratory statement] need not be verified, one might file under assumed names declaratory statements on every tract within the limits of a railroad grant prior to the time of the filing of the map of definite location, and thus prevent the railroad company from receiving any lands. This danger is more imaginary than real. In the first place, for each application fees must be paid, and it is not to be supposed that any one would throw away money for the mere sake of preventing a railroad grant from having any operation. In the second place, such declaratory statements under assumed names would be purely fictitious and could be set aside as absolutely void. Indeed, good faith is presumed to underlie all such applications. The acceptance of the declaratory statement by the local land officers is prima facie evidence that they have approved it as a bona fide application, and if, in any particular instance, it is shown to be purely fictitious, doubtless there is an adequate remedy by proper proceedings in the land office. There is in the case before us no pretense that the transaction was a fictitious one, or carried on otherwise than in perfect good faith on the part of the applicant. At any rate, Congress has seen fit not to require an affidavit to a declaratory statement, and has provided for the filing of such unsworn statement as the proper means for an assertion on record of a claim under the pre-emption law, and that is all that is necessary to except the land from the scope of the grant."

When the grant of July 2, 1864, was made to the Northern Pacific Railroad Company, substantially the entire country between Lake Superior and Puget Sound was, as said by the Supreme Court in *Nelson v. Northern Pacific Railway*, supra,

"untraveled as well as uninhabited, except by Indians, very few of whom, at that time, were friendly to the United States. The principal object of the grant, as will appear from its language, was to secure the safe and speedy transportation of the mails, troops, munitions of war, and public stores, by means of a railroad and telegraph; and to that end, and in order to bring the public lands into market, it was deemed important to encourage the settlement of the country along the proposed route. The public lands in that vast region were unsurveyed, and it was not known when they would be surveyed.

Congress, of course, knew that, if immigrants accepted the invitation of the government to establish homes upon the unsurveyed public lands, they would do so in the belief that the lands would be surveyed, that their occupancy would be respected, and that they would be given an opportunity to perfect their titles in accordance with the homestead laws."

In that case, as has been seen, the Supreme Court distinctly held that the settlement, improvements, and possession by Nelson of the land there in controversy, with a bona fide intention to acquire the government title thereto under the homestead laws, at the time the map of the definite location of the line of the Northern Pacific Railroad Company was filed, excepted the land so claimed from the grant; such land then being unsurveyed, for which reason there could not then have possibly been any record in the land office of the homesteader's claim.

The judgment is reversed, and the case remanded to the court below, with directions to give judgment for the complainant.

MORROW, Circuit Judge (dissenting). In my opinion the question involved in this case has been clearly and distinctly decided by the Supreme Court of the United States in a number of cases. When the controversy between the land grant railroad companies and the settlers first arose with respect to lands within the place limits of the grant, it involved two questions: First, did the right of the railroad company attach to the odd-numbered sections described in the grant upon the fixing of the general route of the line of road, or upon the filing of the map of definite location of the line of road, in the land office? Second, did the right of the pre-emption or homestead settler attach upon the settlement upon the land, or upon his entry of the land in the land office? With respect to these two questions the law was declared to be that the opposing rights of the railroad company and an individual entryman were to be determined, not by the fixing of the general route of the road by the railroad company, or the mere occupation of the land by the pre-emption or homestead settler, but by the state of the record in the land office. On the part of the railroad company, its right did not attach to the lands within the place limits of the grant until it had definitely located the line of its road, as shown by the accepted map of its line of road filed in the land office; and on the part of the pre-emption or homestead settler, his right did not attach until he had made an entry of the land in the land office. Whichever of these acts was first in point of time was first in right. This was the state of the law until May 14, 1880, when Congress passed the act providing that a homestead settler on unsurveyed land should be allowed the same time to file his homestead application and to perfect his original entry in the land office as was then allowed to a pre-emption settler. 21 Stat. 140, c. 89 (U. S. Comp. St. 1901, p. 1392). This was a period of three months from the date of the receipt at the district land office of the approved plat of the township embracing the settlement. Under this act the settler on unsurveyed land had for the first time the right to enter land and have the entry relate back to the date of settlement, but such right was only acquired by complying with the statute.

In *Kansas Pacific Railway Company v. Dunmeyer*, 113 U. S. 629, 640, 5 Sup. Ct. 566, 28 L. Ed. 1122, the homestead entry was made July 25, 1866. The line of the definite location of the company's road was filed with the Commissioner of the General Land Office at Washington September 21, 1866. Referring to the filing of the map of definite location of the road, the court said:

"When the line was fixed, which we have already said was by the act of filing this map of definite location in the General Land Office, then the criterion was established by which the lands to which the road had a right were to be determined. Topographically this determined which were the 10 odd sections on each side of that line where the surveys had then been made. Where they had not been made, this determination was only postponed until the survey should have been made. This filing of the map of definite location furnished also the means of determining what lands had previously to that moment been sold, reserved, or otherwise disposed of by the United States, and to which a pre-emption or homestead claim had attached; for by examining the plats of this land in the office of the register and receiver, or in the General Land Office, it could readily have been seen if any of the odd sections within 10 miles of the line had been sold, or disposed of, or reserved, or a homestead or pre-emption claim had attached to any of them."

Again, on page 641 of 113 U. S., page 571 of 5 Sup. Ct. (28 L. Ed. 1122), the court said:

"It is not conceivable that Congress intended to place these parties as contestants for the land, with the right in each to require proof from the other of complete performance of its obligation. Least of all is it to be supposed that it was intended to raise up, in antagonism to all the actual settlers on the soil, whom it had invited to its occupation, this great corporation, with an interest to defeat their claims, and to come between them and the government as to the performance of their obligations. The reasonable purpose of the government undoubtedly is that which it expressed, namely, while we are giving liberally to the railroad company, we do not give any lands we have already sold, or to which, according to our laws, we have permitted a pre-emption or homestead right to attach. No right to such land passes by this grant."

And again, on page 644 of 113 U. S., page 573 of 5 Sup. Ct. (28 L. Ed. 1122):

"Of all the words in the English language, this word 'attached' was probably the best that could have been used. It did not mean mere settlement, residence, or cultivation of the land; but it meant a proceeding in the proper land office by which the inchoate right to the land was initiated. It meant that by such a proceeding a right of homestead had fastened to that land, which could ripen into a perfect title by future residence and cultivation. With the performance of these conditions the company had nothing to do. The right of the homestead having attached to the land, it was excepted out of the grant as much as if in a deed it had been excluded from the conveyance by metes and bounds."

In *Maddox v. Burnham*, 156 U. S. 544, 546, 15 Sup. Ct. 448, 39 L. Ed. 527, the settler, Maddox, had gone upon the land in October, 1866, but made no attempt to enter it as a homestead until the succeeding spring, and after the withdrawals in favor of the railroad company had been ordered by the Secretary of the Interior. It appeared, however, that after Maddox and his father-in-law had gone upon the land the latter went to the land office for Maddox and himself to get permission from the register of the land office to go upon the land, put up houses, and live in them until the following spring, when they

would enter the land as homesteads. The register gave the permission, and under this permission they occupied the lands and made improvements, and when they went in the succeeding spring for the purpose of making their homestead entries they were told that the land had been withdrawn. Upon these facts the settler insisted that his equitable rights in occupying the land and placing improvements thereon antedated the withdrawals and were superior to the legal title. In denying these alleged equitable rights the Supreme Court said:

"This claim of the defendant cannot be sustained. At the time of these transactions the mere occupation of land, with a purpose at some subsequent time of entering it for a homestead, gave to the party so entering no rights. The law in force (Act May 20, 1862, c. 75, 12 Stat. 392), made the entry of the land office the initial fact. Section 1 authorized any one possessed of the prescribed qualifications 'to enter one quarter section, or a less quantity, of unappropriated public lands.' Section 2 provided that the person applying should, upon his application, make affidavit, among other things, 'that such application is made for his or her exclusive use and benefit, and that said entry is made for the purpose of actual settlement and cultivation, * * * and upon filing the said affidavit with the register or receiver, and on payment of \$10, he or she shall thereupon be permitted to enter the quantity of lands specified.' So the law stood until May 14, 1880 (21 Stat. 141, c. 89 [U. S. Comp. St. 1901, p. 1393]), when an act was passed, the third section of which is as follows: 'Sec. 3. That any settler who has settled, or who shall hereafter settle, on any of the public lands of the United States, whether surveyed or unsurveyed, with the intention of claiming the same under the homestead laws, shall be allowed the same time to file his homestead application and perfect his original entry in the United States land office, as is now allowed to settlers under the pre-emption laws to put their claims on record, and his right shall relate back to the date of settlement, the same as if he settled under the pre-emption laws.'"

The court, in referring to the settler's occupation of the land, said:

"It is true that he claims that he had permission from the register of the land office to go upon the land and occupy it; but the register had no power to give such permission. He had no general control over the unappropriated public lands. He could vest no rights, legal or equitable, in any individual other than such as are authorized by statute. His authority was limited to receiving and acting upon applications for homestead or pre-emption entry, and it cannot be that any such unauthorized permission of a local land officer can create a right not given by the statute, or defeat a title conveyed by the government in full compliance with the law."

In *Tarpey v. Madsen*, 178 U. S. 215, 222, 20 Sup. Ct. 849, 44 L. Ed. 1042, the subject was again reviewed by the Supreme Court and it was held that the opposing rights of an individual entryman to the railroad company were to be determined by the state of the record in the land office. Whether the court intended to say that the act of May 14, 1880, to which reference was made, applied only to a controversy between individual occupants of the land, and not to a controversy between an individual entryman and the railroad company, is immaterial in this case, in view of later decisions. What the court said was this:

"It is undoubtedly true that one occupying land with a view of pre-emption is given 30 days within which to file with the register of the land office his declaratory statement (Rev. St. § 2264), and since 1880 the same right has been possessed by one desiring to make a homestead entry (Act May 14, 1880, c. 89, § 3, 21 Stat. 141 [U. S. Comp. St. 1901, p. 1393]). So that any controversy between two occupants of a tract open to pre-emption and homestead entry is

not determined by the mere time of the filing of the respective claims in the land office, but by the fact of prior occupancy, and these controversies are of frequent cognizance. Oral evidence, therefore, of the date of occupancy, may be decisive of the controversy between such individual applicants for a tract of public land, but by decisions of this court, running back to 1882, as between a railroad company holding a land grant and an individual entryman the question of right has been declared to rest not on the mere matter of occupancy, but upon the state of the record."

Again, on page 227 of 178 U. S., page 853 of 20 Sup. Ct. (44 L. Ed. 1042), the court said:

"And surely Congress, in making a grant to a railroad company, intended that it should be of present force, and of force with reasonable certainty. It meant a substantial present donation of something which the railroad company could at once use, and use with knowledge of that which it had received. It cannot be supposed that Congress contemplated that, as in this case, a score of years after the line of definite location had been fixed and made a matter of record, some one should take possession of a tract apparently granted, and defeat the company's record title by oral testimony that at the time of the filing of the map of definite location there was an actual, though departed, occupant of the tract, and therefore that the title to it never passed."

In *Northern Pacific Railroad Company v. Colburn*, 164 U. S. 383, 17 Sup. Ct. 98, 41 L. Ed. 479, it was distinctly held that mere occupation of land by a homestead settler, unaccompanied by a filing of the claim in the land office, did not exclude a tract from the operation of the grant to the railroad company. It is true that the land there claimed to have been occupied by the homestead settler at the time of the definite location of the line of the railroad was surveyed public land. In the present case the land was unsurveyed, but under Act May 14, 1880, c. 89, 21 Stat. 140 (U. S. Comp. St. 1901, p. 1392), and section 2266 of the Revised Statutes the homestead settler was allowed three months after the receipt of the plat of survey at the district land office to file his homestead application. If he filed this application within this time it was provided that "his right should relate back to the date of the settlement, the same as if he settled under the pre-emption laws." It was only upon complying with this statute that the previous occupation of unsurveyed land by the homestead settler was recognized as "a claim." If he failed to comply with the statute, his occupation of the land at the time of the definite location of the line of road was precisely the same as though the land had been surveyed at the time of such location and he had failed to make his claim of record in the land office at that time. The land would not be excluded from the grant. In this case, in referring to the decision of the Supreme Court of Montana, the court said:

"And if it be true, as matter of law, that mere occupation or cultivation of the premises at the time of the filing of the map of definite location, unaccompanied by any filing of a claim in the land office then or thereafter, excludes the tract from the operation of the land grant, the decision of the Supreme Court of Montana was right. But frequent decisions of this court have been to the effect that no pre-emption or homestead claim attaches to a tract until an entry in the local land office."

The decision in the case of *Nelson v. Northern Pacific Railroad Company*, 188 U. S. 108, 23 Sup. Ct. 302, 47 L. Ed. 406, is not in conflict with these prior decisions. The railroad grant under considera-

tion in that case was the same as in the present case. The railroad company had fixed the general route of its road extending coterminous with the land in controversy and within 40 miles thereof by filing a plat of such route with the Commissioner of the General Land Office on August 20, 1873. It had also definitely located the line of its railroad coterminous with and within less than 40 miles of the land on December 6, 1884. Three years prior to the latter date Nelson, who was then conceded to have been qualified to enter public lands under the homestead act, went upon and occupied the land in controversy and continued to reside thereon. The land was not surveyed until 1893, but as soon as it was surveyed he attempted to enter it under the homestead laws of the United States. His application was rejected solely because, in the judgment of the local land office, it conflicted with the grant to the Northern Pacific Railroad Company. The opinion of the court, by Mr. Justice Harlan, reviews previous decisions of the Supreme Court and the Department of the Interior for the purpose of determining whether the railroad company acquired a vested interest in the land upon the fixing of the general route of the road opposite the land in controversy on August 20, 1873, or when the line of the road was definitely located on December 6, 1884. From this review the court reached the conclusion that the railroad company acquired no vested interest in any particular section of land until after the definite location of the line of its road had been made, as shown by the accepted map of its line filed in the land office on December 6, 1884. Three years prior to the latter date, as before stated, Nelson had gone upon and occupied the land as a homestead settler, and the court was of opinion that:

"His continuous occupancy of it, with a view, in good faith, to acquire it under the homestead laws as soon as it was surveyed, constituted * * * a claim upon the land within the meaning of the Northern Pacific act of 1864."

In another place the court says:

"He [Nelson] acted with as much promptness as was possible under the circumstances."

Again:

"The settler waited from 1881 to 1893 for the land to be surveyed, and as soon as that was done he attempted to enter it under the homestead law in the proper office."

The court, referring to the provisions of the act of May 14, 1880, says:

"Nelson settled on unsurveyed public land, in which the railroad company had no vested or specific interest, and the third section of the act of 1880 was purposeless, if it did not allow him to perfect his title under the homestead laws *as soon as the land was surveyed.*"

The last five words of this quotation are italicized by the court to emphasize the fact that Nelson had his claim of a homestead on record in the land office in accordance with the provisions of the act of 1880, thus making the entry relate back to the occupation of the land by him and giving him a right prior to the definite location of the road.

At the same term of the court at which the Nelson Case was decided the Supreme Court decided the case of Oregon & California Railroad Company v. United States, 189 U. S. 103, 23 Sup. Ct. 615, 47 L. Ed. 726. The opinion of the court was also by Mr. Justice Harlan. The controversy in that case involved the construction of the grant to the California & Oregon Railroad Company (Act July 25, 1866, c. 242, 14 Stat. 239), the terms of which, so far as the present question is concerned, are substantially the same as those of the Northern Pacific Railroad grant. In that case, as in the Nelson Case, the railroad company had received patents from the United States under its grant to the lands in dispute. That case involved lands within the indemnity limits of the railroad grant. The lands had been occupied for a number of years previous to the completion of the survey by the homestead settlers. Immediately upon the completion of the survey, and before any claims by the homestead settlers had been filed, the railroad company selected the lands as part of its grant. After such location, but within the 90 days allowed by the act of May 14, 1880, applications to enter the lands as homesteads were made by the occupants of the lands. The court held that the rights of the occupants under the circumstances were superior to those of the railroad company, on the ground that after the lands had been surveyed the settler had promptly taken the necessary steps to protect his rights under the homestead laws. The court says:

"But it is contended that, as the selection by the company * * * was prior to the application by the respective settlers for entry under the homestead laws, its right to the lands in question was superior to that asserted by the settlers. This view is completely met by the fact that the settler, by prior occupancy in good faith, could avail himself of the homestead acts whenever, by an official survey, the way is opened by the government for him to do so, and by the fact that, within 90 days after these lands were surveyed, he filed in the proper office his application to enter them under the homestead laws of the United States. He moved with due diligence to protect and perfect the right acquired by his occupancy of the land with the intention to avail himself of the benefit of those laws. That right was not to be affected or impaired by the fact that the lands were not surveyed at the date of occupancy. *Nelson v. Northern Pacific Railway*, above cited; *Ard v. Brandon*, 156 U. S. 537, 543, 15 Sup. Ct. 406, 39 L. Ed. 524; *Tarpey v. Madsen*, 178 U. S. 215, 219, 20 Sup. Ct. 849, 44 L. Ed. 1042. * * * In the *Tarpey Case* it was said that 'the right of one who has actually occupied [public lands] with an intent to make a homestead or pre-emption entry cannot be defeated by the mere lack of a place in which to make a record of his intent,' and that if a settler was in possession before definite location, 'with a view of entering it as a homestead or pre-emption claim, and was simply deprived of his ability to make his entry or declaratory statement by the lack of a local land office, he could undoubtedly, when such office was established, have made his entry or declaratory statement in such way as to protect his rights.' So, if the condition of the lands, being unsurveyed, prevents the making by a bona fide occupant of a proper application of record to enter them under the homestead laws his rights will not be lost, if, after the lands are surveyed, he applied in due time to enter the lands under those laws. And such has been held to be the object and effect of Act May 14, 1880, c. 89, 21 Stat. 140 (U. S. Comp. St. 1901, p. 1392)."

The contention of the appellant that the opinion of the Supreme Court in these cases must be construed in the light of the opinion of the court in the case of *Northern Pacific Railroad Company v. Sanders*, 166 U. S. 620, 17 Sup. Ct. 671, 41 L. Ed. 1139, may be admitted;

but such a construction does not change the law with respect to the question now under consideration. In the Sanders Case the Northern Pacific Railroad Company brought suit to recover possession of an odd-numbered section within the primary limits of its grant. Prior to the definite location of the line of its railroad opposite to and past the section of land in dispute, certain persons qualified to enter mineral lands under the laws of the United States entered upon the land in controversy and filed upon it as mineral land, applying for patents therefor and conforming in all respects to the provisions of the laws of the United States relating to "mineral lands and mining resources." Applications for these lands as mineral lands were pending in the land office undetermined at the time the railroad company filed its map of definite location. The defendants, who subsequently entered into the possession of the lands, did not assert title in themselves at the time of the definite location of the line of railroad, but resisted the claim of the railroad company upon the ground that the lands were excluded from its grant by reason of the fact that there were claims to the lands pending in the land office at the time of the definite location of the road. The claims consisted, as stated, in the application of certain persons to purchase the lands as mineral lands. The lands were not in fact mineral lands, and it does not appear what became of the applications. The court, in commenting upon this feature of the case, said:

"As the lands in question were not free from those claims at the time the plaintiff definitely located its line of road, it is of no consequence what disposition was or has been made of the claims subsequent to that date."

The court accordingly held that the lands did not pass to the railroad company by the terms of the grant, for the reason that claims to the land were pending in the land office at the time of the definite location of the road. The distinction to be drawn between that case and the one at bar is the fact that in the former case the applications to purchase the land as mineral land were on file and pending in the land office undetermined when the line of definite location of the road was fixed, while in the present case no such application was pending, nor, under the law, was it permissible for the homestead settler to make application for a homestead upon unsurveyed land. As said by the Secretary of the Interior in *Southern Pacific Railroad Co. (Branch) v. Lopez*, 3 Land Dec. Dep. Int. 130, 131, cited as authority in *Nelson v. Northern Pacific Railway Company*, supra:

"Under the homestead law it is the 'entry' which reserves land (except for the short period during which it is reserved by settlement under the act of May 14, 1880), and not any occupation by the claimant before or after it."

In *Sturr v. Beck*, 133 U. S. 541, 547, 10 Sup. Ct. 350, 352, 33 L. Ed. 761, decided in 1890, the Supreme Court held that:

"A claim of the homestead settler * * * is initiated by an entry of the land, which is effected by making an application at the proper land office, filing the affidavit, and paying the amounts required by sections 2238 and 2290 of the Revised Statutes (U. S. Comp. St. 1901, pp. 1367, 1389)."

It appears that on July 6, 1882, the Northern Pacific Railroad Company filed with the General Land Office its map of definite location

of the line of said railroad, coterminous with and within less than 40 miles of the land in controversy. One Martin Lamlein settled upon the land in the year 1877, and continued to reside thereon until his death in August, 1889. During this time the land was unsurveyed, and therefore not open to entry as a homestead. Preceding Lamlein's death the appellant succeeded to Lamlein's possessory right by purchase or an agreement to purchase the improvements on the land. The appellant has since continued to reside upon the land. The land was surveyed in 1891, and the township plat of the survey embracing it was filed in the land office August 10, 1891. No attempt was made to enter the land by any one until June 29, 1896, when the appellant applied to make a homestead entry. There was, therefore, no entry of record in the land office at the time of the definite location of the line of the railroad, and no entry was made within three months from the date of the receipt at the district land office of the approved plat of survey of the township embracing the land, under the provisions of the act of May 14, 1880. The land was, therefore, free from any homestead claim or right, and the title passed to the railroad company under the grant.

It is contended further by appellees that Lamlein was not a qualified entryman and that his occupation of the land at the time of the definite location of the line of railroad did not exclude it from the grant to the railroad company for the following reasons: (1) It is not shown that Lamlein was a citizen of the United States. (2) It is not shown that Lamlein was not the proprietor of more than 160 acres of land in any state or territory of the United States. (3) It appears from the evidence that prior to Lamlein's death he had sold or agreed to sell whatever right he had to the land to the appellant. It is contended that under section 2290 of the Revised Statutes, as amended by Act March 3, 1891, c. 561, § 5, 26 Stat. 1095, 1096 (U. S. Comp. St. 1901, p. 1389), this act amounted to an abandonment of the land. It would seem that either of these objections would be sufficient to defeat Lamlein's homestead claim.

In my opinion the decree of the Circuit Court should be affirmed.

McCARTHY et al. v. BUNKER HILL & SULLIVAN MINING & CONCENTRATING CO. et al.

(Circuit Court of Appeals, Ninth Circuit. November 6, 1908.)

No. 1,397.

1. APPEAL AND ERROR (§ 1009*)—REVIEW—DECREE GRANTING OR REFUSING INJUNCTION.

It is a well-established rule that an appellate court will not ordinarily interfere with the action of a trial court in either granting or withholding an injunction in cases in which the evidence is substantially conflicting, and especially where the trial judge at the request of the respective parties has had the benefit of a personal inspection of the premises which are the subject of controversy.

[Ed. Note.—For other cases, see Appeal and Error, Cent. Dig. § 3972; Dec. Dig. § 1009.*]

*For other cases see same topic & § NUMBER in Dec. & Am. Digs. 1907 to date, & Rep'r Indexes

2. INJUNCTION (§ 23*)—ENJOINING LAWFUL BUSINESS—BALANCING OF EQUITIES.

Where it is sought to enjoin a lawful business, the court should give due consideration to the comparative injury which will result from the granting or refusal of the injunction sought.

[Ed. Note.—For other cases, see Injunction, Cent. Dig. § 22; Dec. Dig. § 23.*]

3. INJUNCTION (§ 24*)—ENJOINING LAWFUL BUSINESS—COMPARATIVE INJURIES.

A court of equity properly refused to grant a permanent injunction which would necessitate the closing of mines and mills employing from 10,000 to 12,000 men and in which large capital was invested, practically destroying the business of important towns and markets for the products of many farms, because, as shown by a preponderance of the evidence, a comparatively small amount of damage was done by tailings discharged from the mills into a stream to farm lands below in times of overflow, where by the laws of the state the mines were given priority of right to the use of the waters of the stream and the owners had done all that could reasonably be done to prevent injury to others by the construction of dams and reservoirs for settling basins, and especially where actions at law commenced by many of the complainants to recover damages for the same acts of defendants were pending and undetermined.

[Ed. Note.—For other cases, see Injunction, Cent. Dig. § 23; Dec. Dig. § 24.*]

Appeal from the Circuit Court of the United States for the Northern Division of the District of Idaho.

For opinion below, see 147 Fed. 981.

The bill in this case was filed in the court below November 23, 1904. It was brought by the appellants McCarthy, Raney, and Doty against the Bunker Hill & Sullivan Mining & Concentrating Company, Federal Mining & Smelting Company, the Gold Hunter Mining & Smelting Company, corporations, and Peter Larson and Thomas L. Greenough, copartners under the firm name and style of "Larson & Greenough." After alleging the jurisdictional facts, the bill averred that in the year 1891 McCarthy acquired under the homestead laws of the government, and has ever since owned and possessed, certain described tracts of land in Kootenai county, Idaho; that Raney also acquired, and has ever since owned and possessed, certain tracts of government land in the same county and state, and that the complainant Doty, on March 7, 1902, acquired under the homestead laws 151 acres in the same county and state, upon which he has since resided; that all of the tracts so owned by the complainants are situate in the valley of the Cœur d'Alene river, contiguous to that stream, level, and prior to the acts complained of were of great fertility and value, producing large and valuable crops of hay, grain, vegetables, and other agricultural products, a large portion of the land being a natural meadow; that the aggregate value of the complainants' land and that of their associates represented by them, as afterwards alleged, is more than \$800,000; that at the time the complainants, and nearly all of the parties mentioned in the bill as their associates, acquired their land, and before the acts of the defendants complained of, the waters of the Cœur d'Alene river and its tributaries were pure, clear, and wholesome, abounding in trout and other food fish, and were in every respect adapted to use for domestic purposes and the watering of stock, and the channel of the stream was very deep and navigable for steamboats of large size and deep draught from its confluence with Lake Cœur d'Alene to a point about 35 miles above called "Mission," and was so navigated daily by large boats to said point and by smaller ones about 14 miles further up the river, which boats passed near the lands of the complain-

*For other cases see same topic & § NUMBER in Dec. & Am. Digs. 1907 to date, & Rep'r Indexes

ants and their said associates, furnishing them with valuable and economical facilities for commerce and transportation for the products of their farms and for the bringing in of supplies and continuous travel, without change of conveyance, from Mission to Cœur d'Alene City on Lake Cœur d'Alene, about 60 miles therefrom, and to other towns and landings on said river and lake and other streams flowing therein, the competition of which boats kept down charges for freight and passenger rates to a reasonable and inexpensive charge, and also compelled the Oregon Railroad & Navigation Company, which operates a railroad along the river and lake, and very near thereto, to keep down the charge of freight and passenger rates to a low and reasonable charge; that the river and its tributaries, particularly the south fork of the stream, also furnished the complainants and their alleged associates with valuable and convenient facilities for floating timber, logs, cordwood, railroad ties, and like commodities from points along the river and from their own farms to the city of Spokane, in the state of Washington, where are situated mills for the manufacture of lumber and like commodities; that sometime prior to the year 1888, the defendant the Bunker Hill & Sullivan Mining & Concentrating Company became the owner of certain mining claims located in Shoshone county, Idaho, under the provisions of the mining laws of the United States, such mining claims being situated upon and in the hills overlooking and contiguous to Milo creek, a tributary of the south fork of the Cœur d'Alene river, and many miles above where the river flows by and through the lands of the complainants and their alleged associates; that, after acquiring these mining claims, the Bunker Hill Company commenced to extract the ores and minerals therefrom, and have since continued so to do, and threaten to do so indefinitely; that, in working its claims, that company has extracted and is continuing to extract therefrom, and threatens to continue so to do, great quantities of lead and silver ores, which require and will require treatment to separate the lead, silver, and other minerals from the base rock and earth in which they are found, for which purpose the Bunker Hill Company, about the year 1899, erected upon the banks of the south fork of the Cœur d'Alene river, at a point more than 50 miles above where the river flows by and through the lands of the complainant Doty, and a greater or less distance above where it flows through the lands of the other complainants and their alleged associates, a mill or concentrator, where it has ever since continued to treat the ores, with the results afterwards stated; that, from the time of the erection of the concentrator or mill, that company has run through it, and is still running through it, about 2,000 tons of ore per day, about 75 per cent. of which consisted and still consists of rock and earth, which, after the lead, silver, and other valuable minerals are extracted, is cast by the defendant into the said south fork of the river or upon the banks thereof, which deposits are from time to time, by the natural action and drainage of the waters, washed and carried into the south fork and thence into the Cœur d'Alene river, resulting in the filling up of its channel and the poisoning and polluting of its waters; that the said company's method of working the ores requires the flowing of a large stream of water through its concentrator in the process of treating the ores, which water becomes so charged with lead and other poisonous material that it is rendered destructive to all vegetation with which it comes in contact, and poisonous to any animals which drink of such waters or eat of any vegetation which has been overflowed by them, or which have been grown upon the lands through which such waters have percolated or flown, and is poisonous to fish within said waters; that such waters, after so flowing through the said concentrator and being so polluted and poisoned, have been by the said company, during the times stated, and still are and will continue to be, unless enjoined therefrom, turned into the said south fork of the Cœur d'Alene river, whence the same naturally flows by and through the lands of the complainants and their alleged associates; that the continued depositing by the Bunker Hill Company of crushed rock and material and débris into the said south fork of the Cœur d'Alene river and upon the banks thereof has filled up the channel of the south fork, and since about the year 1900 has been and is now rapidly filling up the channel of the river itself, where the same flows by and through the lands

of the complainants and their alleged associates, to the extent that the river is no longer well defined and its banks rise but little above the stream at low water, so that any slight rise in its waters causes it to overflow its banks and spread over the lands of the complainants and their alleged associates; that the waters of the river are so poisoned and polluted by the aforesaid acts of the Bunker Hill Company and the other defendants that when the river overflows, its waters poison and destroy all vegetation with which they come in contact, and, when they recede, leave a deposit of poisonous sediment that not only destroys vegetation and animal life with which it comes in contact, but destroys and tends to unfit the land for further cultivation.

The bill further alleges that the defendant the Gold Hunter Mining Company, about the year 1886, became the owner of certain mining claims in Shoshone county, under the mining laws of the United States, situated near the town of Mullan, upon the south fork of the Cœur d'Alene river, and for the purpose of treating ores therefrom did likewise erect upon the banks of the south fork, near the town of Mullan, and at a point about 20 miles above where the mill and concentrator of the Bunker Hill Company is situated, and has continued to treat its ores in the same manner and with the same results as is alleged with respect to the Bunker Hill Company; that the defendant Federal Mining & Smelting Company, about the year 1902, acquired certain mining claims, by conveyance from former owners, situate in the hills and mountains overlooking the aforesaid Milo creek, and in the hills and mountains overlooking Canyon creek, a tributary of the south fork of the Cœur d'Alene river, at or near the town of Mace, and have ever since been the owners of two large concentrators or mills, one situate near the town of Kellogg, on the south fork of the river, and the other at the town of Mace, on Canyon Creek, through which defendant has run 2,000 tons per day in like manner and with like results as is alleged with respect to the Bunker Hill Company, and threatens that it will continue to do so indefinitely.

That the defendant Hecla Mining Company, about the year 1898, became the owner of certain mining claims situate in the mountains and hills overlooking the said Canyon creek, at or near the town of Burke, about 20 miles above the mill or concentrator of the Bunker Hill Company, and, for the purpose of treating its ores, erected at or near the town of Burke, and on the banks of Canyon creek, a mill or concentrator, through which it has since run 800 tons of ore per day with like results and in like manner as is alleged with respect to the Bunker Hill Company, and that it will continue so to do indefinitely.

The bill alleges that for many years after the commencement of the operation of the mills or concentrators by the several defendants, as alleged, and for many years after, the complainants and nearly all of their alleged associates severally acquired their respective tracts of land in the valley of the Cœur d'Alene river, the waters of the river were not perceptibly affected by the débris and waste discharged into the tributaries of that stream by the several defendants, for the reason, among others, that there were many pools and deep places in the tributaries where such débris and waste settled, and for the further reason that the amount of ore treated in such mills and concentrators and the amount of waste and débris discharged by the defendants was comparatively small; but from time to time since the first construction of the mills and concentrators each of the defendants has greatly increased the capacity of its mills and concentrators, resulting in an increased discharge by each of them of waste into the tributaries of the river, resulting in the filling up of the pools and deep places and the carrying of such waste further down the stream, so that by the year 1900 such waste and débris commenced to be discharged into the channel of the river itself in large quantities, so that the waters of the river became appreciably polluted thereby, since which date such waste and débris has been discharged in greater and ever-increasing quantities, so that the channel of the river for several miles below the point called "Mission" has been filled up to such an extent that the navigation thereof, even by small boats, has been entirely destroyed excepting during the period of high water; that the channel

of the river has been filled up to such an extent that the banks rise but slightly above the deposits of the waste and débris, and in places the channel has been filled up to more than a depth of 60 feet, according to the information and belief of the complainants, and that the entire channel of the river to the south thereof has been filled up to an ever-increasing degree, and that considerable quantities of pollution caused by such waste and débris is now being carried into Cœur d'Alene Lake, and, unless the defendants are restrained, the entire channel of the river will, by the constant accumulation of the waste and débris, become unnavigable; that such pollution has already destroyed or driven away from the stream all fish; that such waste and débris has already been carried upon the lands of the complainants and their alleged associates to such an extent that many acres of the said lands are now covered with such waste and débris to such a depth as to destroy all vegetation, and that, as the flow of such waste and débris increases from year to year, the area so destroyed is constantly and rapidly enlarging, and that the other lands of the complainants and their alleged associates which are not thus destroyed are being greatly impaired in their fertility and capacity to produce crops; that the pollution caused by the waste and débris settles upon and attaches itself to the growing grass and all vegetation, and incrusts the same with a sediment which is highly injurious to such growing crops and poisonous to all animals that feed thereon, and that when such crops are harvested the sediment deposited on the ground arises in clouds of poisonous dust which diffuses itself through such crops, thereby greatly augmenting its deleterious effect on animals which feed on the same, in consequence of which many horses and cattle belonging to the complainants and their alleged associates have sickened and died, and many more have become sick and diseased, the general knowledge and reputation of which fact among the people of that region has already greatly impaired the marketability of hay and other crops grown on the said lands, so that the merchants and dealers, who were accustomed to buy at the highest market value the products of said lands, refuse now to purchase the same excepting at greatly diminished price, or at all; that, if the defendants are restrained from further continuing the acts complained of, the lands of the complainants will become fertile and productive, and the crops growing thereon merchantable and fit for use and for feeding of domestic animals, excepting such portions as are already covered with such sediment and waste as to have already destroyed their fertility; that at the time the complainants and their alleged associates acquired their land it could not be foreseen or apprehended that the amount of mineral-bearing ore in the vicinity of the tributaries of the river would ever be sufficient to pollute the waters thereof, or destroy their lands; that ever since the lands of the complainants and their alleged associates commenced to be seriously damaged by the acts of the defendants, complained of, the former have made repeated efforts to induce the defendants to take some steps to protect them from such damages and the other damages threatened, and to compensate them for the damages already suffered, but the defendants have failed and refuse to provide any relief for the injuries complained of, but, on the contrary, conspired with others and organized themselves with others into an association known as the "Mine Owners' Association," the purpose of which organization was and is to prevent the complainants and their alleged associates, and others similarly situated, from securing any redress, and to enable them by such combination to continue the alleged unlawful acts complained of, and to harass them with vexatious, expensive, and ruinous litigation, the complainants and their alleged associates being men of small means and for the most part having no property or resources aside from their said lands and the crops grown thereon, so that the complainants and their alleged associates were compelled to associate themselves together for the purpose of mutual aid and assistance in securing redress for the alleged wrongs, of which association the complainant Raney is president, and the complainant McCarthy secretary, the said association being composed of the following named persons, each of whom is the owner of a valuable farm in the valley of the Cœur d'Alene river, in all respects similar to the farms of the complainants, the lands and crops of each

of whom is being injured and damaged in the same manner and with like effect as the lands of the complainants; such alleged associates being D. E. Blair, William Ehlert, Harry Weigel, A. J. Rasor, John Graf, E. M. Newcomb, W. S. Snider, David Brown, R. D. McKinnis, Archille Fortier, Samuel Reed, Chas. Smith, Johanna Hurlinger, Mary R. Schaughnessy, Chas. McMillan, R. W. Bacon, Carl Graf, M. J. Sanders, Chas. Fisher, Alva Ellis, J. H. Mauck, Joseph M. Brown, T. K. Hireen, L. C. Armstrong, Wm. Gassel, L. P. Hyde, David Holderman, John Fisher, A. J. Snyder, P. L. Roscoe, Martin Arnold, Andrew Bergstrom, William Byers, Mary E. Brown, Walker R. Davis, J. E. Eells, R. A. Grover, Alfred W. Jansen, Martin Kottnek, John H. Mottern, Edmund D. Oman, Elmer Packer, Mrs. William Alcenda Payne, P. J. Whalen, Clarence A. Packer, Thomas E. Williamson, Theresa Jorgens.

The bill further alleges "that your orator, Elmer Doty, has already brought legal actions in your honorable courts to recover damages from the said defendants for injuries to his own lands and crops and to the lands and crops of those associated with him, which actions at law, on account of the large number of defendants, all of whom have contributed to the said injuries, are very vexatious and expensive to your said orator and his said associates, and that since the commencement of said actions these defendants have continued to do and commit all of the acts complained of, and are still so committing such acts, and since the commencement of said actions the lands and crops of your orator, and those associated with him, have been greatly damaged by the acts complained of as done and committed by these defendants, and, unless said defendants are restrained and enjoined by your honors from a further continuance of the acts complained of, your orators and those associated with them will be compelled to enter into innumerable actions at law to recover their just damages resulting from the acts complained of, which constitute a public nuisance and a continuing trespassing upon the lands of your orators and those associated with them, and a great multiplicity of suits will necessarily result."

The bill further alleges that the defendants thereto, and each of them, claim the right to operate their said mining claims and their said mills and concentrators, and to deposit the rock, earth, and other débris therefrom, where the same will be carried into the waters of the Cœur d'Alene river and its tributaries, under and by virtue of the provisions of the act of Congress, approved July 26, 1866 (14 Stat. 251, c. 262), entitled "An act granting the right of way to ditch and canal owners over the public lands and for other purposes," and the act amendatory thereof, and particularly under sections 5, 8, and 9 of the act of July 26, 1866; and under the provisions of the act of Congress, approved July 9, 1870 (16 Stat. 217, c. 235), entitled "An act to amend an act granting the right of way to ditch and canal owners over the public lands, and for other purposes," and particularly under the provisions of section 17 of the last-mentioned act; and under the provisions of the act of Congress, approved May 10, 1872 (17 Stat. 91, c. 152), entitled "An act to promote the development of the mining resources of the United States," and the acts amendatory thereof and supplementary thereto; and under the provisions of section 14 of article 1, and of sections 1 and 3 of article 15, of the Constitution of the state of Idaho, which provisions of the Constitution of the state, the defendants, and each of them, claim, were adopted under authority vested in that state by the provisions of the aforesaid mining acts of Congress—all of which claims the complainants deny, and aver that their said rights in and to their said respective tracts of land were initiated and attached to such lands under the provisions of chapter 5, tit. 32, of the Revised Statutes of the United States (U. S. Comp. St. 1901, p. 1338), and the acts of Congress amendatory thereof, and that the provisions of the Constitution of Idaho, if construed as the said defendants claim and pretend that they should be construed, are, as applied to the rights of the complainants and their alleged associates, in conflict with the provisions of section 3 of article 4, and the fifth and fourteenth amendments to the Constitution of the United States. The prayer of the bill is, among other things, for a preliminary and perpetual injunction against the commission by the defendants of any of the alleged unlawful acts.

By their answer the defendants put in issue all of the material allegations

of the bill, and set up, among other things, that in the year 1900 the Buffalo Hump Mining Company was the owner of the Tiger and Poorman and other mining claims situate at the town of Burke, on Canyon creek, and engaged in mining them, and, in connection with that work, owned and operated large concentrating mills at Burke, having a capacity to crush and treat, and which were then crushing and treating, about 600 tons of ore daily; that at the same time the Standard Mining Company was the owner of the Standard and other mining claims situated near the town of Mace, on said Canyon creek, and engaged in mining them, and, in connection with such work, owned and operated a large concentrating mill near the mouth of Canyon creek, which mill had the capacity to crush and treat, and was then crushing and treating, about 600 tons of ore daily from its said mines; that at the same time Richard Wilson, Walter Mackay, James Leonard, William R. Leonard, A. L. Scofield, and the Standard Mining Company owned the Mammoth and other mining claims near said town of Mace, on Canyon creek, and were engaged in mining them, and, in connection therewith, owned and operated a large concentrating mill situated near the mouth of Canyon creek, which mill had the capacity to crush and treat, and was then crushing and treating, about 400 tons of ore daily from their said mines; that at the same time the defendants Peter Larson and Thomas L. Greenough, were the owners of the Morning and Evening and other mining claims situate near the town of Mullan, in the county of Shoshone, on the south fork of the Cœur d'Alene river, and were engaged in mining them, and, in connection therewith, owned and operated a large concentrating mill near the said south fork, and about one mile below the town of Mullan, which concentrating mill had the capacity to crush and treat about 900 tons of ore daily from their said mines; that at the same time the defendant the Gold Hunter Mining & Smelting Company was the owner of the Gold Hunter and other mining claims on the south fork of the Cœur d'Alene river, near said town of Mullan, and was engaged in mining them, and, in connection therewith, owned and operated, near its said mines, a concentrator which had the capacity to crush and treat about 250 tons of ore daily from its said mines; that, at the same time, the defendant Hecla Mining Company was the owner of the Hecla and other mining claims situate near the said town of Burke, on Canyon creek, and was engaged in mining them, and, in connection therewith, was operating a concentrating mill on Canyon creek, with a capacity for crushing and treating about 120 tons of ore daily from its said mines; that in the year 1900 the said owners of the said several groups of mines and mills, and other mine owners, for the purpose of holding and impounding any tailings and waste material produced by the said mines and mills which might escape from their separate and respective works, dams, and impounding reservoirs, purchased a large tract of land, to wit, over 300 acres, in the valley of the south fork of the Cœur d'Alene river, at a point about three miles below the city of Wallace, Idaho, and during the spring and summer of 1901, at great cost and expense, erected thereon a large dam, known as the "Osborn Dam," across said south fork of the Cœur d'Alene river and across a portion of the valley of the said south fork, thus making a large reservoir or storage basin for the holding and impounding of such tailings and other waste material from said mines and mills as might escape from their separate and respective works, dams, and impounding reservoirs; that said reservoir or storage basin is, and has at all times since its construction been, of sufficient size and capacity to catch, hold, and impound all tailings and waste material from the working of said mines and the operation of said concentrators, and is of sufficient size and capacity to catch, hold, and impound all the tailings and waste material which may be produced by the working of said mines and the operation of said mills for many years to come, and is capable of being enlarged so as to accommodate, hold, and impound all the tailings and waste material which may in the future be produced from said mines, as well as any other mines which may be developed on the south fork of the Cœur d'Alene river and its tributaries above said dam; that in the year 1901, and at divers times prior thereto, the said defendants Bunker Hill & Sullivan Mining & Concentrating Company, the Gold Hunter Mining & Smelting Company, Hecla

Mining Company, and Larson & Greenough, and the grantors and predecessors in interest of Federal Mining & Smelting Company, and other mine owners, for the purpose of holding and impounding any tailings and waste material produced by their said mines and mills which might escape from their separate and respective works, dams, and impounding reservoirs, purchased large tracts of land, to wit, in the aggregate about 2,000 acres, in the valley of the south fork of the Cœur d'Alene river, at a point about four miles below the town of Kellogg, Idaho, and about two miles below the said mill and impounding works of the said defendant Federal Mining & Smelting Company, and, during the fall and winter of the year 1902, at great cost and expense, erected thereon a large dam known as the "Pine Creek Dam," across the said south fork of the Cœur d'Alene river and across the entire valley of the said south fork of the Cœur d'Alene river, thus making a large reservoir or storage basin for the holding and impounding of such tailings and other waste material from their said mines and mills as might escape therefrom and from their separate and respective works, dams, and impounding reservoirs; that said reservoir or storage basin is, and has at all times since its construction been, of sufficient size and capacity to catch, hold, and impound all the tailings and waste material from the working of said mines and the operation of said concentrators, and is of sufficient size and capacity to catch, hold, and impound all the tailings and waste material which may be produced by the working of said mines and the operation of said mills and concentrators for many years to come, and is capable of being enlarged so as to accommodate, hold, and impound all the tailings and waste material which may in the future be produced from said mines, as well as from other mines which may be developed on the south fork of the Cœur d'Alene river and its tributaries above said dam; that at all times since the construction of said dams and storage basins, down to and until the present time, all the debris and waste material which have, in the process of mining and milling of their respective ores, escaped from their respective mills, works, dams, and impounding reservoirs and been carried away by the waters of the said south fork of the Cœur d'Alene river and its tributaries, and each thereof, have been caught, held, and impounded in said dams and storage basins, and none of the same has floated down or been carried down below said dams; that the lands claimed by the complainants, and each of them, and those associated with them and whom they claim to represent, and each of them, mentioned and described in the bill of complaint, are situate in the valley of the Cœur d'Alene river below said Osborn dam from 21 to 56 miles, and below said Pine Creek dam from 10 to 45 miles, and that at no time since the construction of said dams have any tailings or other waste material from the working of any of said mines or the operation of any of said mills or any mines or mills on the south fork of the Cœur d'Alene river, or any of its tributaries above said dam, ever floated down or been washed or carried down to said lands or any part thereof or any lands claimed by the complainants or their associates, or any of them, or to any point below said dams; that said Osborn dam is located more than three miles below the nearest of the mills and about ten miles from the farthest of the mills of the defendants that are situated above said dam, and that the Pine Creek dam is located about eleven miles below the said Osborn dam, and two miles below said Federal Mining & Smelting Company's mill, which is the lowest mill on the south fork of the Cœur d'Alene river; that the mill of the defendant Bunker Hill & Sullivan Mining & Concentrating Company and the said last-mentioned mill of the defendant Federal Mining & Smelting Company are the only mills operated between the said Osborn and Pine Creek dams; that the said Pine Creek dam is below the mines and mills of the said defendants and every mine and mill that is operated in the county of Shoshone, Idaho, upon the south fork of the Cœur d'Alene river or any of its tributaries; that the said defendant Bunker Hill & Sullivan Mining & Concentrating Company now is, and at all times during its mining and milling operations in the said county of Shoshone, Idaho, has been, working and operating its mines and mill on its own account, separately and independently of all other persons or companies, and that, ever since the construction of said dams and storage basins, it has borne and paid its share

of the costs and expenses of keeping up and maintaining the same; that the said defendant Federal Mining & Smelting Company was never engaged in any mining or concentrating or treating of ores prior to the 1st day of September, 1903, on which day it acquired by purchase all the mines, mills, water rights, and all the property of said the Standard Mining Company, the Empire State-Idaho Mining & Developing Company, and the said Richard Wilson, Walter Mackay, James Leonard, William R. Leonard and A. L. Scofield, being the same mines and mills above mentioned as belonging to them, together with their interest in said dams and storage basins, and ever since has been and is now working and operating said mines and concentrators on its own account, separately and independently of all other persons or companies; and ever since said purchase said defendant Federal Mining & Smelting Company has borne and paid its share of the costs and expenses of keeping up and maintaining said dams and storage basins; that the said defendant the Gold Hunter Mining & Smelting Company now is, and at all times during its mining and milling operations in the said county of Shoshone has been, working and operating its mines and mills on its own account, separately and independently of all other persons or companies, and that, ever since the construction of said dams and storage basins, it has borne and paid its share of the costs and expenses of keeping up and maintaining the same. Similar allegations to the last are also made in the answer in respect to the Hecla Mining Company and the defendants Larson & Greenough.

The answer further avers that, in the mining and working of said mines, and the crushing, concentrating, treating, and separation of the metals from the gangue and waste rock, no poisonous or deleterious substance or substances destructive to animal or vegetable life are used by the said defendants, or any of them, nor do they use anything but pure water therein, and in the concentration and treatment of said ores no poisonous or deleterious substance or substances destructive to animal or vegetable life are left in the tailings or waste material; and so the defendants aver that the complainants have not, nor has either or any of them, nor their associates or either or any of them, directly or indirectly, suffered any wrong, injury, or damage at the hands of the said defendants or any of them, or by reason of any work, act, or thing done by the said defendants, or any or either of them; that, for a period of over 15 years prior to the commencement of this suit, other mining companies and persons than the defendants herein, owning and operating their respective mines and properties in the county of Shoshone, Idaho, mined, milled, treated, and concentrated their ores and used the waters of the south fork of the Cœur d'Alene river and its tributaries above the lands claimed by the said complainants and their said associates in the mining, milling, and concentration of their ores and ore bodies, and that, if the said complainants, or any or either of them, or their associates or any or either of them, ever suffered any damages or injuries complained of in their bill of complaint, which the defendants deny, such damages or injuries, and each thereof, if in any manner caused by any mining and milling operations and the use of the waters of the south fork of the Cœur d'Alene river and its tributaries in such mining and milling operations, were caused by such other companies and persons, and not by the defendants herein, or any or either of them; that if any poisonous or destructive or deleterious substances or material or any minerals have been or can be found in the channel of the Cœur d'Alene river, or on the lands, or any part thereof, of the said complainants, or either of them, or their associates, or either of them, or in the valley of the said Cœur d'Alene river, as the result of any mining or milling operations in the county of Shoshone, Idaho, which these defendants do not admit, they say that the same is not the result of or a consequence of any of the mining or milling operations of the said defendants, or any of them, in the said county or elsewhere, and that, since the construction of said dams, it has been impossible for any débris or waste material from the mining and milling operations of the said defendants, or any of them, to escape or be carried unto the said Cœur d'Alene river; that, for a period of over 15 years prior to the commencement of this suit, the inhabitants of the towns and cities of the county

of Shoshone, Idaho, located along and contiguous to the south fork of the Cœur d'Alene river and its tributaries above the said lands claimed by the said complainants and their alleged associates, and each of them, have used the waters of the said south fork of the Cœur d'Alene river and its tributaries as a sewer, and into which waters the sewage from said towns and cities has, during said period of time, been dumped and emptied and thereby carried away, and that if, at any time mentioned in said bill of complaint, the waters of the said south fork of the Cœur d'Alene river or its tributaries, or the said Cœur d'Alene river, have become unfit for domestic uses and purposes, it is by reason of the fact of the dumping and emptying of said sewage into the waters thereof, and not by reason of any mining or milling operations of the said defendants, or any of them; that the mines, mills, and concentrators of the said defendants are situated in the mining region of the county of Shoshone, Idaho, known as "The Cœur d'Alene," having a population of over 12,000 inhabitants, producing about 40 per cent. of the lead mined in the United States, and annually a mineral product of lead and silver of about \$13,000,000, estimated upon the New York quotations as afterwards stated; that the said inhabitants of said region are dependent for their employment, livelihood, and support, and all other business enterprises therein for their continuation, upon the unhampered and continued working, development, and operation by the defendants herein and others engaged in mining and milling in said district of their said mines, mills, and concentrators as they are at present and have been in the past; that the closing down of said mining and milling industries, and the prevention of the development, working, and operation as at present and heretofore of the said mines, mills, and concentrators of the defendants by the injunctive process of the court in this suit, would close not only all mines, mills, and concentrators of the defendants herein, but all other mines, mills, and concentrators in said region, destroy absolutely the business of mining and milling therein and all other business, cause a loss to the defendants herein alone of an invested capital of not less than twelve millions of dollars, and an actual loss of over twenty-five millions of dollars, and a loss to the said inhabitants of said region and other property owners therein of over fifty million dollars, retard the development of the natural resources of the state of Idaho, ruin mining, which is the chief industry and source of income of its people, destroy the value of millions of dollars of invested capital, suspend all other business enterprises, turn thousands of men out of employment, beggar their families, bankrupt said inhabitants and property owners, depopulate one of the largest producing and richest mining regions of the United States, and eliminate annually from the productive wealth of the United States thirteen million dollars; that the cutting off by the injunctive process of this court in this suit of the lead product of said region produced by said defendants from the lead market of the United States, and the elimination of said product therefrom, would result in the suspension of all lead smelting operations on the Pacific Slope, and seriously embarrass all other lead smelting in the United States; that the mines of said region produced during the year 1904, 217,365,165 pounds of metallic lead and 6,252,383 ounces of silver, of a value of \$12,930,123.26, estimated upon the New York quotations, to wit, 57 cents per ounce of silver and 4.309 cents per pound for lead; that, of the said metallic product of said region during the year 1904, the said defendants produced 200,235,283 pounds of lead and 5,094,752 ounces of silver, of the value of \$11,532,146.98; that mining in the state of Idaho is its chief and most important industry; that for the years 1903 and 1904 the mines of said region produced over 79 per cent. of the total mineral output of the state of Idaho; that the entire value of all wheat, oats, barley, rye, corn, flax, potatoes, and hay grown and produced in the state of Idaho for the year 1903 amounted to \$15,181,194, only about \$2,000,000 more than the mineral product of the said Cœur d'Alene region for the year 1904; that the mineral product in lead and silver of said Cœur d'Alene region for the year 1904, estimated upon the above quotation for lead and the coinage value of silver such as the government of the United States takes in estimating the value of the silver product of the United States, amounted to \$17,459,970.93, or \$2,278,776.93 more than the entire value of the wheat, oats, barley, rye, corn, flax, potatoes, and hay

grown and produced in the state of Idaho during the year 1903; that there are at the present time employed in said region in the said mining and milling industry therein 2,654 men, who are receiving an aggregate daily wage of \$8,672.50, and an aggregate yearly wage of \$3,165,462.50, and who would lose their said employment and wages by the suspension of the mining and milling operations in said region by the said injunctive process of this court in this suit, and that the property claimed by the complainants and their associates, and each of them, in said bill of complaint would thereupon have absolutely no value whatever; that, of the said men employed at the present time in said region in said mining and milling industries, 2,029 are employed by the defendants herein, to whom they pay an aggregate daily wage of \$7,405.85, and an aggregate yearly wage of \$2,703,135.25; that the said mines of the said defendants would have to be abandoned, and the working and development thereof discontinued, unless they are permitted to use the waters of the south fork of the Cœur d'Alene river and its tributaries in the mining, milling, concentration, and treatment of the ores extracted therefrom, in the same manner and with the same appliances already employed by them; that the mills and works of the said defendants are all equipped with the best and latest improved fixtures and machinery known to the ingenuity of man and the science of mining and milling for the lawful, safe, economical, healthful, and wholesome use of the said waters in their said respective mining and milling operations and the concentration and treatment of their said ores; that, at all times complained of by the complainants, the defendants, their grantors and predecessors in interest, had and held, by virtue of prior appropriation and ownership, the right to use the waters of the south fork of the Cœur d'Alene river and its tributaries in the mining, concentration, and treatment of their ores, and the ores of each of them, and the right to have the tailings and refuse matter arising from such works carried away by the waters of said streams, and that said right has become a vested one, and that the use of the waters, as aforesaid, of said stream is authorized and protected by the laws and Constitution of the state of Idaho, and that the said defendants and their grantors and predecessors in interest have used the waters of the said stream for said mining, milling, and concentrating purposes openly, notoriously, publicly, and continuously, and with the knowledge of said complainants and each of them, and of their said associates and each of them, and adversely to them and each of them and the whole world, for more than 16 years prior to the commencement of this suit, and that if said complainants or their associates, or any of them, have any rights in the premises, which these defendants deny, they are subject to the vested and accrued rights of said defendants and their grantors and predecessors in interest; that heretofore, and at a time when all the lands through which the south fork of the Cœur d'Alene river and its tributaries run were vacant, unoccupied, unclaimed, unsurveyed public lands of the United States, and at a time when the lands now claimed by the complainants and their associates, and each of them, in their said bill of complaint, were also a part of the vacant, unoccupied, unclaimed, unsurveyed public lands of the United States, the grantors and predecessors of the defendants in interest entered upon the said public lands and appropriated a part of the waters of the said south fork of the Cœur d'Alene river and its tributaries for the purpose of mining, treating, and concentrating the ores from the mines now belonging to said defendants and each of them, and which were then held by their grantors and predecessors in interest, and that, during all the time since such appropriation of said waters, the grantors and predecessors in interest of the defendants, and the defendants, have appropriated and used the waters of the said south fork of the Cœur d'Alene river and its tributaries in the mining, concentrating, and treatment of the ores from the mines of the said defendants; that the right to use said waters for the purposes aforesaid became, at the time of said appropriation, and ever since has been, and now is, a vested right, and at all times has been, and is now, recognized by the local customs, laws, and decisions of the courts, and that the alleged settlement of the complainants and their associates and their grantors and predecessors in interest, and each of them, if they ever made any settlement upon the lands mentioned in their said bill of complaint, or any of them, as well

as their alleged homestead claims allowed thereon, together with the patents issued therefor, were each and all subsequent and subject to the location of said mining claims and the appropriation and use of said waters as aforesaid; that said homestead claims allowed and patents granted therefor, each and all were subject to said vested and accrued water rights and the rights to the use of the said waters by the said defendants and their grantors and predecessors in interest; that if the said complainants, or any of them, or their associates, or any of them, have received a patent or patents from the United States for any of the lands claimed by them or any of them, which the defendants do not admit, there is contained therein a reservation and exception, which reservation and exception is in the words and figures as follows, to wit: "To have and to hold (the premises conveyed) subject to any vested and accrued water rights for mining agricultural, manufacturing or other purposes, and rights to ditches and reservoirs used in connection with such water rights as may be recognized and acknowledged by the local customs, laws and decisions of courts;" that the rights of the said defendant to the use of the waters of the said south fork of the Cœur d'Alene river and its tributaries in the mining, concentration, and treatment of the ores from its mines, under said appropriation of said waters by the grantors and predecessors in interest of the said defendants, as aforesaid, is one of the vested rights reserved and excepted by said provision in said patent aforesaid; that it is the intention of the said defendants to conduct in the future their mining and milling operations in the most careful and painstaking manner, and to use the best and latest devices, machinery, appliances, and works in the same, and in the storage and impounding of said debris and waste material; that for more than 10 years prior to the commencement of this suit the said complainants and their associates, and each of them, knew that the said defendants and their grantors and predecessors in interest were operating their respective mines, and milling, concentrating, and treating the ores therefrom, in the same manner in which the said defendants are now operating their mines and treating, concentrating, and milling the ores therefrom, and that the said defendants and their grantors and predecessors in interest had expended in the construction of said mining plants, mills, and concentrators, and in the development of their respective mines, many millions of dollars, and were furnishing, and said defendants still are furnishing, employment to many thousands of men; that during all of said period of time said complainants and their associates, and each of them, stood by, acquiesced in, and permitted the said defendants, their grantors and predecessors in interest, to build up their large and expensive plants, mills, and concentrators, and develop their said mines at said enormous expenditure of money, without any protest or objection whatever until within a few months prior to the commencement of this suit, and up to within a few months prior to the commencement of this suit made no claim or demand whatever upon the said defendants, or any of them, nor did they, or either of them, excepting the said complainant Doty, as hereinbefore stated, take any action to assert or enforce their alleged claims or demands for equitable or any relief against said defendants, or any of them, on account of any of the acts, conduct, or doings on the part of the said defendants, or any of them, or on account of the acts or conduct of any of their grantors or predecessors in interest, or for any relief whatever relative to the matters or things complained of in the said bill of complaint, nor have the said complainants or their associates, or either or any of them, shown any excuse whatever on their part, or on the part of each of them, for their delay, and the delay of each of them, in asserting their alleged claims for the relief asked for in the said bill of complaint, nor for their long-continued acquiescence in the established and vested rights of the said defendants, and each of them, in the premises; that the said complainants and their associates are not, nor is either of them, entitled to any relief prayed for, for the reason that their alleged causes of action are barred by their laches, and the laches of each of them, in the respects set forth, and the defendants deny the unlawful combination set out in the bill, and pray that the suit be dismissed at the complainants' cost.

The record contains a large amount of testimony and a vast number of exhibits introduced in evidence on behalf of the respective parties, resulting up-

on final hearing in a judgment denying the injunction prayed for, with costs to the defendants.

William T. Stoll and W. C. Jones, for appellants.
C. W. Beale and Albert Allen, for appellees.

Before GILBERT and ROSS, Circuit Judges, and HUNT, District Judge.

ROSS, Circuit Judge (after stating the facts as above). The extent and value of the mining operations of the appellees are not controverted, and it is practically conceded on behalf of the appellants that the granting of the injunction to which it is insisted they are entitled must necessarily result in closing those great operations in the Cœur d'Alene region, in the depopulation of that section of country, the destruction not only of the mining business there, but the business of the numerous towns that are shown by the record to be wholly dependent upon that industry, and the depriving of many of the farmers themselves in the valley of the Cœur d'Alene river of a market for their products. If the established principles of equity entitle the appellants to this drastic relief, it must, as a matter of course, be awarded them, however disastrous the consequences. But is the case made by the record such as to demand or even justify the injunction sought? It is very evident from the record that the exaggerations and misstatement of matters of fact is very gross. The briefs also disclose intense feeling on the part of the opposing counsel, which, perhaps, is not unnatural in view of all of the circumstances of the case and of the large interests involved. With this latter feature, however, we, of course, have nothing to do. The case itself is, like all such cases are, of very great importance, and calls for the exercise of the greatest care and caution in its consideration and disposition, lest the weak be not afforded the protection to which they may be justly entitled, and, on the other hand, lest the strong be denied their just rights, acquired in the pursuit of enterprises not only lawful in themselves, but sanctioned and encouraged by both national and state legislation, and redounding to the great good of thousands of people and to the country as a whole. The testimony and exhibits are altogether too voluminous to permit of a specific review of them in an opinion of reasonable length, so we shall confine ourselves to a brief statement of the principles by which we are guided, and of the grounds upon which we rest our judgment.

In all of the mining states the right to the reasonable use of the public streams for mining purposes is given by usage, custom and law, and by section 3 of article 15 of the Constitution of the state of Idaho, where the properties here in question are situate, miners are given the preferred right to the use of the waters of the streams of that state over, among others, manufacturers and agriculturists. Such right, however, is not unlimited, and does not carry with it the right to destroy the property of any other person. In other words, the maxim, "Sic utere tuo ut alienum non lædas," applies to such a case, and in all cases where the property of any one is injured by such unreasonable use of such a stream the injured party has the absolute and unqualified

right to maintain an action for the damages sustained. And, in this very instance, the record before us affirmatively shows that, prior to the institution of the present suit, the appellant Doty, in behalf of himself and his alleged associates, did bring actions at law against the appellees for the recovery of damages for the same alleged wrongful acts here complained of, which law actions were pending at the time of the bringing of the present suit, and presumably are still pending.

To an injunction, however, even on final hearing, no one has an absolute and unqualified right. Such an application appeals to the conscience of the chancellor, to the exercise of a wise and sound discretion, and should be granted or withheld according to the equities of the case as made to appear by the record. Each case must be considered and made to depend upon its own particular facts and circumstances, in the consideration and determination of which the general rules governing courts of equity are to be borne in mind and applied. Among those rules is the well-established one that an appellate court will not ordinarily interfere with the action of the trial court in either granting or withholding an injunction in cases in which the evidence is substantially conflicting, and especially where the trial judge, at the request of the respective parties, has had the benefit of a personal inspection of the premises. Nor should an injunction be granted in any case where it will necessarily operate contrary to the real justice of the case. Furthermore, where, as in the present case, it is sought to enjoin a lawful business, the court should give due consideration to the comparative injury which will result from the granting or refusal of the injunction sought. We so held in the case of *Mountain Copper Co. v. United States*, 142 Fed. 625, 73 C. C. A. 621, and the Supreme Court of the United States has so held in several cases, and in three very recent and very important ones. Especially where, as appears by the record before us, the appellants have pending against the appellees actions at law, previously commenced, to recover damages for the same alleged acts, should a court of equity be very slow to stop the vast operations here in question, thereby throwing out of employment thousands of men, practically wiping out of existence important towns, ruining a large number of business men, destroying markets for the crops of many farms, and where the business in and of itself is not only not unlawful, but, by the Constitution of the state in which all of the properties in question are situate, is expressly given the preferred right over the great industry of agriculture itself, and where, by Congressional legislation as well as by usage, custom, and laws in all of the mining states and territories, it is sanctioned and encouraged. Especially, too, should a court of equity be very slow to grant such an injunction, with the necessary consequences stated, in advance of a trial of the law actions for damages already brought and pending, and where, as here, the appellees deny the existence of the facts upon which the conclusion that a nuisance exists are based, where the evidence is very conflicting, and where it is most difficult to ascertain the exact truth as between the conflicting statements. Every presumption must, of course, be indulged that the appellants will receive justice in the court in which they have brought their

actions at law for damages, and in which actions the appellees may avail themselves of a jury trial upon the question of the existence of the alleged nuisance, as well as upon the question of the alleged damages. In the case of *Parker v. Winnipisogee Lake & Woolen Co.*, 67 U. S. 545, 552, 553, 17 L. Ed. 333, the Supreme Court said:

"Where an injunction is granted without a trial at law, it is usually upon the principle of preserving the property until a trial at law can be had. A strong prima facie case of right must be shown, and there must have been no improper delay. The court will consider all the circumstances and exercise a careful discretion. * * * After the right has been established at law, a court of chancery will not as of course interpose by injunction. It will consider all the circumstances, the consequences of such action, and the real equity of the case."

If, as there expressly held by the Supreme Court, and as we have heretofore said, a court of equity will consider all the circumstances, the consequences of injunction and the real equity of the case, even after a right has been established at law, a fortiori will such a court consider all of those matters where the action at law has been commenced but not tried.

In the cases of *New York City v. Pine*, 185 U. S. 93, 22 Sup. Ct. 592, 46 L. Ed. 820, *Kansas v. Colorado*, 206 U. S. 46, 27 Sup. Ct. 655, 51 L. Ed. 956, and *Georgia v. Tennessee Copper Co.*, 206 U. S. 230, 27 Sup. Ct. 618, 51 L. Ed. 1038, the Supreme Court also held that one has not the absolute and unqualified right to an injunction even on final hearing. In the case of *New York City v. Pine*, the plaintiff claimed the right to enjoin the city from building a dam and diverting the waters of a certain stream that flowed through their farms in the state of Connecticut. The Supreme Court, for the purpose of its decision, assumed, among other things, that the plaintiffs had the legal right to such flow of the waters of the stream, but notwithstanding that, among other assumptions, it held that the plaintiffs were not entitled to the perpetual injunction awarded by the lower court; saying:

"This is not a case between two individuals in which is involved simply the pecuniary interests of the respective parties. On the one side are two individuals claiming that their property rights are infringed—rights which can be measured in money, and that not a large sum; on the other, a municipality undertaking a large work with a view of supplying many of its citizens with one of the necessities of life. According to the averments in the bill, the city had been engaged in this work for two years, and had nearly completed the dam. While the near completion is denied in the answer, there is no denial of the time during which the city had been engaged in the work, and it stands as an admitted fact that for two years prior to the commencement of this suit the work had been under way. It is true the testimony discloses that the plaintiffs and the city had been trying to agree upon the amount of compensation for the injuries they would sustain, and were not insisting upon their alleged right to an abandonment of the work. It is one thing to state a right and proffer a waiver thereof for compensation, and an entirely different thing to state the same right and demand that it should be respected. In the latter case the defendant acts at his peril. In the former he may well assume that payment of a just compensation will be accepted in lieu of the right. In the latter the plaintiff holds out the single question of the validity and extent of the right; in the former he presents the right as the foundation of a claim for compensation, and his threat to enforce the right if compensation is not made is simply a club to compel payment of the sum he deems the measure of his damages. Further, the testimony shows that

the city was settling with other parties similarly situated, and paying out large sums of money for the damages such parties would sustain. So it is not strange that the city acted on the assumption that the only matter to be determined was the amount of the compensation.

"If the plaintiffs had intended to insist upon the strict legal rights (which for the purposes of this case we assume they possessed), they should have commenced at once, and before the city had gone to expense, to restrain any work by it. It would be inequitable to permit them to carry on negotiations with a view to compensation until the city had gone to such great expense, and then, failing to agree upon the compensation, fall back upon the alleged absolute right to prevent the work. If they had intended to rest upon such right and had commenced proceedings at once, the city might have concluded to abandon the proposed undertaking and seek its water supplies in some other direction. If this injunction is permitted to stand, the city must pay whatever the plaintiffs see fit to demand, however extortionate that demand may be, or else abandon the work and lose the money it has expended. While we do not mean to intimate that the plaintiffs would make an extortionate demand, we do hold that equity will not place them in a position where they can enforce one."

In a case between two sovereign states—Kansas and Colorado—in which circumstances the court held, in effect, in the case of *Georgia v. Tennessee Copper Co.*, 206 U. S. 230, 27 Sup. Ct. 618, 51 L. Ed. 1038, that it was less willing to balance harm than in cases between private individuals, it nevertheless distinctly held in *Kansas v. Colorado*, 206 U. S. 46, 27 Sup. Ct. 655, 51 L. Ed. 956, as will be seen from its summing up on page 117 of 206 U. S., on page 675 of 27 Sup. Ct. (51 L. Ed. 956), that the diversion of the waters of the Arkansas river in Colorado, resulting in great good to that state, was of perceptible injury to portions of the Arkansas valley in Kansas, particularly those portions closest to the Colorado line, but that to the great body of the valley it had worked little, if any, detriment; and, in view of those facts, the court held upon final hearing that it was not satisfied that Kansas had made out a case entitling it to a decree. At the same time it held it to be obvious that, if the depletion of the waters of the river by Colorado continues to increase, there might come a time when Kansas would be entitled to an injunction; so, in dismissing the bill of complaint, it did so "without prejudice to the right of the plaintiff to institute new proceedings whenever it shall appear that, through a material increase in the depletion of the waters of the Arkansas river by Colorado, its corporation or citizens or substantial interests of Kansas are being injured to the extent of destroying the equitable apportionment of benefits between the two states resulting from the flow of the river."

And the same court expressly declared the same principle in the case of *Georgia v. Tennessee Copper Co.*, 206 U. S. 230, 27 Sup. Ct. 618, 51 L. Ed. 1038. See principal and concurring opinions, pages 233, 240, of 206 U. S., pages 619, 620, of 27 Sup. Ct. (51 L. Ed. 1038).

The record in the case before us shows that upon all of the material facts undertaken to be shown by the complainants there not only appears to be a very substantial conflict in the proofs, but, in some respects at least, the preponderance of the evidence seems to be largely in favor of the defendants. Take, for instance, the claim on the part of the complainants of the death of some of the complainants' stock by reason of drinking the waters of the river. The number of wit-

nesses who testified on behalf of the defendants to the effect that the complainant's stock did not die by reason of mineral poison in the waters of the river (and whose testimony, so far as we can know, is entitled to as much credence as the complainants' witnesses) are not only greater in number, but their testimony to the effect that there were similar deaths of stock in the bottom lands of other rivers in Idaho, as well as along a river in British Columbia where there was no mining, is suggestive and confirmatory of the contention upon that point upon the part of the defendants. But what seems to be quite conclusive upon that point is the uncontradicted testimony in the record to the effect that ever since the establishment of the mines and mining towns along the branches of the Cœur d'Alene river, and nearer to the mills and works of the appellees, animals of all kinds—dairy cows, horses, and dogs—as well as people, have regularly drunk the waters of the river, and that in no single instance was there ever a death from mineral poison. Then, too, the testimony seems to decidedly preponderate in favor of the defendants upon the proposition that there has been no such general and serious damage to the agricultural lands of the valley as is claimed on the part of the complainants, and, indeed, excepting a few and very restricted areas, no damage at all. That seems to be indicated by a strong preponderance of the testimony to the effect that, excepting in comparatively narrow and restricted strips along a few of the ditches or gulleys through the lands of a few of the complainants, no lead or zinc was found in the numerous analysis made of the lands that were periodically overflowed by the river, and, by what seems to be pretty well established, that the crops of the valley in the year 1905, after the last freshet, never were so good before, and by the numerous photographs of the various ranches in the valley, which, so far from indicating any serious damage, show an unusual and vigorous growth of crops of various kinds. It is true that photographs are not very reliable, since the camera may be so placed as to give a deceptive impression. Still, in view of the large number of photographs and the general character of the crops and growth indicated by them, they are in some respects confirmatory of the contentions on the part of the appellees. The facts stated by the trial judge in his opinion in the case, especially in view of his personal inspection of the premises, made at the request of the respective parties, are, we think, entitled to great weight. From his findings, and also from the testimony introduced, it seems clear that the allegations and contentions on the part of the appellants to the effect that the operations of the appellees have resulted in interfering with the navigation of the river are entirely unfounded.

Upon the record before us we hold that the court below should have dismissed the bill of complaint at the cost of the complainants, without prejudice, however, to any other or further suit of the complainants, or either of them, in the event that any other or further injury than is here shown shall be shown to have been sustained by them, or either of them, and, of course, without prejudice to any action or actions for damages actually sustained by them or either of them. The

case is remanded to the court below with directions to modify the judgment as indicated, and, as so modified, it will stand affirmed.

In view of the very important principles and of the large interests involved, it is further ordered that our mandate be stayed for 90 days in order to afford the aggrieved parties an opportunity to apply to the Supreme Court for a writ of certiorari, in the event they shall so desire.

HITE & RAFETTO v. SAVANNAH ELECTRIC CO.

(Circuit Court of Appeals, Fifth Circuit. November 17, 1908.)

No. 1,798.

SALES (§ 22*)—REQUISITES AND VALIDITY—PROPOSAL AND ACCEPTANCE—ACCEPTANCE VARYING FROM OFFER.

Defendants made a written proposal to furnish a quantity of coal to plaintiff which clearly embodied the terms of the proposed contract. Such proposal was verbally accepted by plaintiff's agent, and it was agreed that he should prepare a formal written contract to be signed by the parties. This he did, and submitted the same to defendants on the next day, but it contained provisions materially varying from those of the proposal and more favorable to plaintiff, and defendants refused to sign it and withdraw their offer. *Held*, in an action by plaintiff to recover damages for breach of the contract made by the verbal acceptance of the original offer, that in proposing a contract materially variant from such offer it virtually took the position that its acceptance thereof was not unconditional and binding upon it, and could not therefore insist that it was binding on defendants, who were at liberty to also treat the negotiations as still open and withdraw their offer.

[Ed. Note.—For other cases, see Sales, Cent. Dig. §§ 39-43; Dec. Dig. § 22.*]

In Error to the Circuit Court of the United States for the Southern District of Georgia.

This is an action for damages for the breach of a contract brought by the Savannah Electric Company against Hite & Rafetto. On September 18, 1905, Hite & Rafetto, through their agents, the Dixon Lumber Company and G. R. Gabell, made proposals to the Savannah Electric Company for supplying it with 12,000 tons of coal. Two propositions in writing were submitted by Hite & Rafetto through their agents; one related to "Peerless Georges Creek coal"; the other related to "Monarch Georges Creek coal." Both propositions were similar, with the exception that the price of the Peerless coal was \$3.30 per ton and the price of the Monarch coal was \$3.20 per ton, a difference of 10¢ per ton. The Peerless proposition was definitely rejected. After some negotiations, Nash, who was the manager of the Savannah Electric Company and the person with whom the negotiations were conducted, on behalf of that company, stated verbally that he would accept the Monarch proposition, which is as follows:

"Savannah, Ga., Sept. 18th, 1905.

"Savannah Electric Co., Savannah, Ga.

"Gentlemen: We beg to submit the following proposition for supplying you with fuel:

"Coal:

"Monarch, Georges Creek, mined on the Baltimore & Ohio Railroad, near Johnstown, Penna. This coal runs low in volatile matter, approximately 16

*For other cases see same topic & § NUMBER in Dec. & Am. Digs. 1907 to date, & Rep'r Indexes

per cent. to 17 per cent., about 1 per cent. in sulphur, and about 6 per cent. to 7 per cent. in ash.

"Quantity and Supply:

"Twelve thousand tons. Deliveries to commence as soon as practicable and be made so as not to exceed maximum storage capacity of 3,000 tons.

"Supply to be Guaranteed:

"If at any time we are unable to ship coal from Baltimore, Md., or Philadelphia, Pa., account condition of the harbors, we reserve the right to ship a good grade of steam coal from Norfolk or Newport News while the above condition exists.

"Price:

"\$3.20 per gross ton of 2240 pounds, delivered your wharf, Savannah.

"Settlements:

"Settlement to be made thirty days from date of bill of lading. Bill of lading weights to govern settlement.

"Quality and Analysis:

"The coal to be of satisfactory quality. In case any cargo or cargoes should cause complaint, we or our representative to be notified, samples taken and analysis made. The price of such cargo or cargoes to be adjusted as per method attached, which would then be considered a part of our contract.

"Certificate of Origin:

"If at any time during the life of the contract you desire substantiating evidence that the coal loaded is what we agree to ship we are prepared to secure from the railroad company certificate sworn to before a notary public, confirming the contents of such cargo.

"Very truly yours,

The Dixon Lumber Company,

"Jas. M. Dixon, Sec'y & Treas.

"Agents for Hite & Rafetto,

"By G. R. Gabell."

Attached to the foregoing was the following paper:

"Savannah Electric Company's Contract.

"The coal shall have approximately the following composition:

Moisture	1.00%
Volatile Carbon.....	20.00%
Ash	7.00%
Sulphur	1.00%

"Premiums and Fines:

"Coal exceeding 1% moisture, excess deducted from bill. Coal having less than 1% moisture, deficit added to bill.

"Coal exceeding 20.00% volatile carbon, excess percentage multiplied by two and deducted from bill. Coal having less than 20.00% volatile carbon, deficit percentage multiplied by one and added to bill.

"Coal exceeding 7% in ash, excess percentage multiplied by three and deducted from bill. Deficit, under 7%, multiplied by one and a half and added to bill.

"Addition and Deductions:

"The additions will not go to increase the contract price of the coal, but only to offset any deductions which may be determined by an analysis:

"Method of Sampling:

"A sample to be taken from every tenth bucket (or each, if desired). The pile of coal obtained to be thoroughly mixed and quartered. Two quarters to be thrown out and the remaining two to be mixed and quartered. This process to be repeated until the pile of coal remaining is small enough to be placed in two quart preserve jars. These jars to be sealed and labeled, and one sent to the chemist for analysis and the other retained by the consumers for our use, if desired. Our representative to be notified and sampling taken in his presence, if desired."

In answer to the question, "What, if anything, was said about drawing up a formal paper?" Nash testified:

"I told Messrs. Dixon and Gabell I would be glad to have the whole thing signed by both parties and before he left, if possible, and, inasmuch as the proposition was submitted in letter form, as there was only one copy of it, it should be redrawn, with several copies, so each of the three parties who were interested could have one, and I would undertake to do that, if possible, before he left town, and just draw the conditions as agreed upon and as shown by that proposition, which was accepted in legal form, so that all could sign it and each have a copy."

Nash undertook to prepare the formal contract. The writing prepared by him is as follows:

"State of Georgia, Chatham County.

"Memorandum of an agreement made and entered into this 19th day of September, 1905, between Hite & Rafetto, a co-partnership, with principal office in the city of Philadelphia, Pa., party of the first part, and the Savannah Electric Company, a corporation under the laws of said state and county, party of the second part.

"Witneseth: Whereas the party of the first part desires to furnish and the party of the second part to purchase a supply of coal sufficient for the operation of the power stations of the party of the second part for approximately one year.

"Now, therefore, the parties hereto have agreed together as follows:

"First. The party of the first part agrees to furnish coal in accordance with the following details:

"Brand.—Coal to be furnished is known as the 'Monarch' Georges Creek coal, mined on the Baltimore and Ohio Railroad, near Johnstown, Pa.

"Quantity and Supply.—This contract covers twelve thousand (12,000) gross tons, delivery of which shall commence in November, and continue at such intervals as will insure continuous supply without exceeding the maximum storage capacity, which is three thousand (3,000) tons, and as far as practicable not to exceed the normal storage capacity of twenty-five hundred (2,500) tons.

"The party of the first part guarantees to keep the party of the second part continuously supplied with coal during the life of this contract. If at any time it is impossible to ship coal from Baltimore, Md., or Philadelphia, Pa., on account of frozen condition of the harbors, it is agreed that shipment may be made from Norfolk, Newport News, of a similar grade of steam coal while such condition exists.

"Quality and Analysis.—The coal is to be of satisfactory quality, equal to standard Georges Creek, and shall have the following approximate analysis: Moisture 1 per cent., volatile matter 16 per cent. to 17 per cent., ash 6 per cent. to 7 per cent., fixed carbon 75 per cent. to 77 per cent., sulphur 1 per cent. In case any cargo or cargoes shall give unsatisfactory results, the party of the first part or their representatives shall be notified, and samples shall be taken and forwarded to some reputable chemist by whom an analysis shall be made at the expense of the party of the first part, on the basis of which the price shall be adjusted.

"Certificate of Weight and Origin.—The party of the first part agrees to furnish for each cargo of coal shipped a sworn certificate of the railroad company of the weight and original shipping point of the coal.

"Second. In consideration of the above, the party of the second part agrees to pay to the party of the first part for the coal described three dollars and twenty cents (\$3.20) per gross ton 2240 pounds discharged at its wharf in Savannah, stevedores to be selected by the party of the second part. All bills shall be paid within thirty (30) days from date of bill of lading, if deliveries have been made. Bill of lading weights shall govern settlements.

"Third. Should the party of the second part find cause for complaint, of the quality of any particular cargo or cargoes of coal, the price of the coal shall

be corrected for such unsatisfactory quality in accordance with the following method—a standard analysis is assumed, namely:

- "Moisture 1 per cent.
- "Volatile matter 20 per cent.
- "Ash 7 per cent.
- "Fixed carbon 72 per cent.
- "Sulphur 1 per cent.

"Should the analysis of the coal from any cargo show moisture exceeding 1 per cent. the excess over 1 per cent. in per cent. shall be deducted from the contract price of the coal. Should the moisture be less than 1 per cent. the deficit in per cent. shall be added to the contract price of the coal. Should the coal contain more than 20 per cent. volatile matter, the excess over 20 per cent. shall be multiplied by two and deducted from the contract price. Should the volatile matter be less than 20 per cent. the deficit percentage shall be multiplied by one and added to the contract price. Should the ash, as shown by the analysis, exceed 7 per cent. the excess in percentage shall be multiplied by three and deducted from the contract price; should the ash be less than 7 per cent. the deficit under 7 per cent. shall be multiplied by one and a half and added to the contract price.

"It is understood between the parties that the additions above referred to shall not go to increase the contract price of the coal, but only to offset any deductions which may be determined by the analysis.

"Method of Sampling.—A sample shall be taken from every tenth bucket by the party of the second part in the presence of a representative of the party of the first part. The pile of coal thus obtained shall be thoroughly mixed and quartered, the two opposite quarters thrown away and the two others mixed and again quartered; this process to be continued until the two remaining quarters, which shall also be mixed, will fill two one-quart preserve jars. These jars shall be sealed and labeled, one sent by the party of the second part to the chemist for analysis and the other retained by said party for further reference. The report of the chemist shall be final and binding upon both parties as the basis of settlement, unless otherwise agreed upon.

"Alternative Coal.—The party of the second part may, at any time during the life of this contract, order the party of the first part to substitute for a cargo or cargoes, or for the entire balance of the contract, the so-called 'Peerless' Georges Creek coal, which is now being furnished under a contract for 12,000 tons entered into in September, 1904, between the parties. The party of the first part agrees to furnish this coal at a price ten (10) cents greater per gross ton than that named in the contract for the Monarch coal. In all other respects the terms of this contract shall apply.

"In witness whereof the parties hereto have hereunto set their hands and seals the day and year first above written.

"By _____,

"Executed in the presence of:

"Savannah Electric Co.,

"Manning White.

"By L. R. Nash, Mgr.

"As to execution by the Savannah Electric Co."

This formal agreement was signed by the Savannah Electric Company. On September 19th, a copy was sent to the Dixon Lumber Company, and on September 21st a copy was sent to Hite & Rafetto. On October 14, 1905, Hite & Rafetto, in a letter to Nash, manager of the Savannah Electric Company, formally withdrew their original proposition in the following letter:

"Owing to the absence of our Mr. Rafetto in the West for the past two weeks, and our inability to see Mr. Hite, we have not been able to take up the question of form of contract which you sent us under date of September 19th. The form of contract which you sent us differs materially with the proposition as submitted by us under date of September 18th, and we cannot accept it, and, therefore, return it to you and withdraw our proposition. If, however, you desire to negotiate with us further in regard to your coal supply for the following year, we shall be glad to take it up with you, and await your further advices."

The several points of difference between the proposal of September 18th, which was accepted and which is the basis of this action, and the formal contract prepared by Nash, is shown by the following parallel columns:

Proposal of September 18, 1905.

1. The coal to be of satisfactory quality. This coal runs low in volatile matter, approximately 16% to 17%, about 1% in sulphur and about 6% to 7% in ash. Specification attached to letter.

2. Deliveries to commence as soon as practicable, and be made so as not to exceed maximum storage capacity of 3,000 tons.

3. If at any time we are unable to ship coal from Baltimore, Md., or Philadelphia, Pa., account condition of the harbors, we reserve the right to ship good grade of steam coal from Norfolk or Newport News, while the above condition exists.

4. Price: \$3.20 per gross ton of 2240 lbs., delivered your wharf, Savannah.

5. Settlements to be made thirty days from date of bill of lading.

6. If at any time during the life of the contract, you desire substantiating evidence that the coal loaded is what we agree to ship, we are prepared to secure from the railroad company certificate sworn to before a notary public, confirming the contents of such cargo.

7. In case any cargo or cargoes shall cause complaint, we or our representative to be notified, samples taken and analysis made. The price of such cargo or cargoes to be adjusted as per method attached, which would then be considered as part of our contract.

8. (Nothing in proposal on this subject.)

9. (Nothing in proposal on this subject.)

Form of Contract Prepared by Nash.

The coal is to be of satisfactory quality equal to Standard Georges Creek, and shall have the following approximate analysis: Moisture 1%, volatile matter 16% to 17%, ash 6% to 7%, fixed carbon 75% to 77%, sulphur 1%.

Delivery of which shall commence in November and continue at such intervals as will insure continuous supply without exceeding the maximum storage capacity, which is 3,000 tons, and as far as practicable not to exceed the normal storage capacity of 2,500 tons.

If at any time it is impossible to ship coal from Baltimore, Md., or Philadelphia, Pa., on account of frozen condition of harbors, it is agreed that shipment may be made from Norfolk, Newport News, of a similar grade of steam coal while such condition exists.

\$3.20 per gross ton 2240 lbs. discharged at its wharf in Savannah, stevedores to be selected by party of second part.

All bills shall be paid within thirty days from date of bill of lading, if deliveries have been made.

Certificates of Weights and Origin. The party of the first part agrees to furnish for each cargo of coal shipped a sworn certificate of the railroad company of the weight and original shipping point of the coal.

In case any cargo or cargoes shall give unsatisfactory results, the party of the first part or their representative shall be notified, and samples shall be taken and forwarded to some reputable chemist, by whom an analysis shall be made at the expense of the party of the first part, on the basis of which the price shall be adjusted.

The report of the chemist shall be final and binding upon both parties, as the basis of settlement, unless otherwise agreed upon.

Alternative Coal. The party of the second part may at any time during the life of this contract order the party of the first part to substitute for a cargo or cargoes, or for the entire balance of the contract, the so-called

"Peerless" Georges Creek coal, which is now being furnished under a contract for 12,000 tons, entered into September, 1904, between the parties. The party of the first part agrees to furnish this coal at a price 10 cents greater per gross ton than that named in this contract for the Monarch coal. In all other respects the terms of this contract shall apply.

The last clause of the formal contract, which is headed "Alternative Coal," provides that the Savannah Electric Company should have the option to use the Peerless Georges Creek coal instead of the Monarch Georges Creek coal at a price 10 cents greater per ton than the contract price for the Monarch coal. The plaintiff offered to prove by Nash that Gabell had verbally suggested to him that, if they wanted to use Peerless coal as alternative coal under the contract, they might do so at 10 cents advance in price. The court rejected this evidence on the ground that the contract could not be varied by oral evidence. Evidence was offered by Hite & Rafetto to show that there was a substantial difference in price and quality between "Peerless" coal and "Monarch" coal.

The defendants requested the court to direct a verdict for them, because, under the evidence, there was no contract between the parties; the offer of the defendant was not unconditionally and finally accepted and assented to by the plaintiff; but, on the contrary, the plaintiff prepared and sent to the defendants a written contract, already signed by itself, and to be signed by the defendants, which contained materially different terms and conditions from those of the defendants' offer, and the defendants thereupon withdrew their offer. The refusal to so direct the jury is assigned as error.

T. M. Cunningham, Jr. (Lawton & Cunningham, of counsel), for plaintiffs in error.

William W. Osborne and Alexander A. Lawrence, for defendant in error.

Before PARDEE and SHELBY, Circuit Judges, and BURNS, District Judge.

SHELBY, Circuit Judge (after stating the facts as above). The written offer of Hite & Rafetto, dated September 18, 1905, to sell the Monarch coal to the Savannah Electric Company, was accepted by the company. The terms of the contract were clearly shown by the written offer and the verbal acceptance. The sellers failing to furnish the coal as offered, the buyer bought elsewhere at an advanced price, and this action is to recover the difference between the agreed price and the price paid. The difference was \$10,748.67, for which verdict and judgment were given. It is true that the written offer and the acceptance, if nothing more had occurred, would have made a valid contract. The case turns on occurrences which followed.

It was agreed that the contract should be drafted in a more formal manner, and that several copies should be made, and that it should be signed by the parties to it. Mr. Nash, the agent of the buyer, it was agreed, was to rewrite the contract. It does not appear from the evidence admitted on the trial that Nash was authorized to make material alterations in the terms of the contract. On September 19, 1905, the day after the acceptance of the offer, Nash, having prepared the formal contract, sent it to the Dixon Lumber Company, and on Septem-

ber 21, 1905, a copy was sent to the sellers, Hite & Rafetto, at Baltimore, Md. The formal contract, as prepared by Nash, differed materially from the offer of September 18th. The several material variations are fully shown in the preceding statement of the case. The departures were to the advantage of the buyer, for whom Nash was the agent, and to the detriment of the sellers. On October 14, 1905, the sellers wrote to the buyer, declining to accept the contract prepared by Nash, saying:

"The form of contract which you sent us differs materially from the proposition as submitted by us under date of September 18th, and we cannot accept it, and, therefore, return it to you and withdraw our proposition."

The case depends on the question as to whether or not the sellers, on the facts, had the right to withdraw their proposition; or, to state the question differently, whether or not, on the facts, a contract of sale was made, which remains in force, by the offer and acceptance of September 18th.

A common method of entering into a contract is for one person to make an offer to another, and, if the latter accepts it, the contract is perfected. When a contract is claimed to have been made by correspondence, and not in a writing formally signed, the whole of what passes between the parties must be considered. Applying this rule, it has been held by the House of Lords that, though the first two letters of a correspondence seemed to constitute a complete contract, the court might consider subsequent letters and conversations, and reach the conclusion that no complete contract was established. *Hussey v. Horne-Payne*, 4 App. Cas. 311. Where the parties orally, or otherwise, agree upon the terms of a contract, and there is final assent to it, the further agreement or intention to reduce it to a formal writing at a subsequent time does not, of itself, show that the contract is not to be binding unless formally reduced to writing and signed. *Hodges v. Sublett*, 91 Ala. 588, 8 South. 800. Of course, when it appears, notwithstanding the meeting of the minds in verbal or other negotiations, that neither party is to be bound until a formal written contract is made and signed, in such case no contract would be in force until the formal writing was made and signed. *Fredericks v. Fasnacht*, 30 La. Ann. 117. The fact that it was agreed that Nash was to reduce the offer and acceptance to a formal writing, to be signed by the parties, did not suspend or rescind the contract, if one was made by the offer and acceptance. If he had prepared a contract precisely in the terms of the written offer which he had before him, or if he had prepared one without material variance from the offer, and the seller had refused to accept it, the original offer and acceptance would not have been affected. The agreement to have the more formal writing, it has been held, could be looked to as evidence tending to show that the parties did not intend to bind themselves till the negotiations had been reduced to form. *Ridgway v. Wharton*, 6 H. L. Cas. 238; *Wharton v. Stoutenburgh*, 35 N. J. Eq. 266. But, in the case at bar, there seems to have been sufficient reason for making a formal writing and several copies, and it could not be reasonably inferred that any agreement that had been made was to be in abeyance till the for-

mal writing was signed. In *Sanders v. Pottlitzer Bros. Fruit Co.*, 144 N. Y. 209, 39 N. E. 75, 29 L. R. A. 431, 43 Am. St. Rep. 757, it was held, by a divided court, that letters and telegrams which constitute an offer and acceptance of a proposition complete in its terms may constitute a binding contract, although there is an understanding that the agreement shall be expressed in a formal writing, and one of the parties afterwards refuses to sign such an agreement without material modifications. In that case, it appears from the statement in the opinion that the "plaintiffs did prepare and send on the contract precisely in the terms embraced in the foregoing correspondence." The defendant was not satisfied with this, and returned it to the plaintiff. The court held the contract made by the previous correspondence binding.

When Nash was authorized to reduce the offer and acceptance to a formal writing to be signed by the parties, it was, of course, incumbent on him to do it fairly and in good faith. He had the written proposition of sale to guide him. Immaterial variations would have been of no consequence. But, as we have seen, Nash prepared and presented a contract differing in several material points from the offer submitted to the buyer, and these differences were of a kind which were to the disadvantage of the sellers. The formal contract which he prepared is certainly not the proposition and acceptance of September 18th. If we assume that the offer and acceptance is, *prima facie*, evidence of a contract, it is, of course, the contract embraced by the written offer and no other. What is to be inferred by the preparation and presentation by Nash of the formal writing differing in terms from the offer accepted? If he was acting in good faith, the writing prepared by him must be his interpretation and construction of the offer to sell which had been accepted, and if that be true, with the written offer before us, we would be forced to conclude that there was nothing to show that the sellers had made the agreement as construed by Nash. This would lead to the conclusion that the minds of the contracting parties had not met, and that, although the offer and its acceptance was apparently a completed contract, the subsequent occurrences showed that, in fact, there had not been an agreement. But if the offer and its acceptance did, as matter of law, make a contract, it should not be held, and we do not hold, that the subsequent action of the buyer rescinded or canceled it. This plainly could not be done against the wishes of the sellers. Such action could not do more than extend to the sellers the opportunity to withdraw their offer.

If, on the other hand, we infer that the offer was so plain that Nash must have understood its terms, and that the formal writing prepared by him does not present his construction of the offer, but that it is a counter proposition made by him, or an effort to obtain better terms than those embraced in the offer, what then should follow? If the offer and its acceptance was not binding on the buyer, it was not binding on the sellers; for it is axiomatic that, unless both are bound, neither will be bound. *Bishop on Contracts*, § 78. If the buyer was free to propose new terms, the sellers were free to decline them. In suggesting new terms, the buyer, in effect, said that the offer and ac-

ceptance was not final. If not final as to the buyer, it could not be conclusive as to the sellers, and they were free to withdraw from the negotiations. *Bristol, etc., Co. v. Maggs*, 44 Ch. Div. L. R. 618; *Johnson v. Latimer*, 71 Ga. 470. See, also, *Bellamy v. Debenham*, 45 Ch. Div. L. R. 481; s. c., on appeal, 1 Ch. Div. (1891) L. R. 412. The buyer should not be permitted to treat the negotiations as open for the purpose of seeking better terms, and, at the same time, hold them closed so as to bind the sellers if they fail to accept the proposed changes. When it proposes a contract materially variant from the offer, it takes the position that the acceptance of the offer was not unconditional and conclusive. The contract for the breach of which this suit is brought is the offer to sell and the acceptance of the offer. If they stood alone, as we have said, they would contain apparently all the elements of a contract. It seems to us that we cannot be required to stop at the acceptance and refuse to consider what followed. Nash immediately proceeded to prepare the formal writing. It was ready for signing on the next day. If it could have been finished instantly when the offer was accepted, and if Nash could have handed the sellers his draft of the formal contract at the moment of acceptance, the acts all taken together would have meant an acceptance of the offer, with the understanding that it be construed to mean what Nash proposed in the new writing. Clearly, the first offer would not bind the buyer until it was unconditionally accepted, and the new writing would not bind the sellers, it containing new terms, until they agreed to it. *Crossley v. Maycock*, 18 Eq. Cas. 180.

If the sellers, after they received the writing prepared by Nash, had shipped the coal, it would have been uncertain whether they acted on their proposal and its acceptance, or on their consent to the terms of the new instrument. Something remained for them to do to make the situation certain. They must accept the new agreement, or reject it and stand by the first offer and acceptance, or there is uncertainty. The buyer, by tendering a different agreement, had shown that it did not wish to be bound by the first, and it is reasonable and just that this made the sellers free to consent that the buyer should not be bound, thereby obtaining their own release by merely agreeing with the buyer that the first proposal and its acceptance was not final and binding. It would encourage sharp practice and unfair dealing to hold that the buyer could, under pretense of reducing the agreement to a more formal writing, tender a contract much more onerous on the sellers and take the chances of getting it signed, and at the same time keep in force the original agreement with which it was content if it failed to get the better bargain. The buyer should not be allowed to say by its acts that the agreement is not binding as to it, but is conclusive as to the sellers. If it was open to the buyer to disregard its acceptance and to make a new offer, it was open to the sellers to withdraw the one they had made.

The judgment of the Circuit Court is reversed, and the case remanded for a new trial.

LEMON et al. v. UNITED STATES.

(Circuit Court of Appeals, Eighth Circuit. November 11, 1908.)

No. 2,761.

1. POST OFFICE (§ 35*)—OFFENSES AGAINST POSTAL LAWS—USE OF MAILs TO DEFRAUD.

Rev. St. § 5480, as amended in 1889 (Act March 2, 1889, c. 393, 25 Stat. 873 [U. S. Comp. St. 1901, p. 3696]), making it a criminal offense to use the mails in the execution of schemes to defraud, although it specifically names schemes to dispose of counterfeit or spurious money, is not confined to such schemes, but by its terms embraces "any scheme or artifice to defraud."

[Ed. Note.—For other cases, see Post Office, Cent. Dig. § 55; Dec. Dig. § 35.*]

2. INDICTMENT AND INFORMATION (§ 110*)—STATUTORY OFFENSES—LANGUAGE OF STATUTE—OFFENSES AGAINST POSTAL LAWS.

An indictment under Rev. St. § 5480, as amended by Act March 2, 1889, c. 393, 25 Stat. 873 (U. S. Comp. St. 1901, p. 3696), for using the mails to defraud, need not follow the language of the statute, but it is sufficient if the averments bring the charge within the substance and true meaning of the statute.

[Ed. Note.—For other cases, see Indictment and Information, Cent. Dig. §§ 289, 290; Dec. Dig. § 110.*]

3. POST OFFICE (§ 48*)—OFFENSES AGAINST POSTAL LAWS—INDICTMENT FOR USE OF MAILs TO DEFRAUD.

An indictment under Rev. St. § 5480, as amended in 1889 (Act March 2, 1889, c. 393, 25 Stat. 873 [U. S. Comp. St. 1901, p. 3696]), which charges that defendants devised a scheme to defraud intended to be executed, and which was executed, by the use of the mail service of the United States by pretending that they were engaged in a certain solvent banking enterprise, and making other pretenses in relation thereto, which pretenses were false and were made for the purpose of inducing others to deposit money with them or to buy stock, and with the intention of appropriating such money to their own use, is sufficient to charge the offense, and need not specifically charge that defendants knew their bank to be insolvent.

[Ed. Note.—For other cases, see Post Office, Cent. Dig. § 72; Dec. Dig. § 48.*]

4. POST OFFICE (§ 35*)—OFFENSES AGAINST POSTAL LAWS—USING MAILs TO DEFRAUD.

A letter mailed in furtherance of a scheme to defraud, in order to support an indictment under Rev. St. § 5480, as amended in 1889 (Act March 2, 1889, c. 393, 25 Stat. 873 [U. S. Comp. St. 1901, p. 3696]), need not in itself be effective to execute such scheme, but it is sufficient if it was designed for that purpose or to assist in it.

[Ed. Note.—For other cases, see Post Office, Cent. Dig. § 55; Dec. Dig. § 35.*]

5. INDICTMENT AND INFORMATION (§ 196*)—WAIVER OF DEFECTS—DUPLICITY.

The objection, that an indictment is bad for duplicity must be taken by a motion to quash, demurrer, or motion to require an election, and is waived by going to trial without objection.

[Ed. Note.—For other cases, see Indictment and Information, Cent. Dig. § 635; Dec. Dig. § 196.*]

6. CRIMINAL LAW (§ 1148*)—APPEAL—DISCRETION OF TRIAL COURT—CONSOLIDATION OF INDICTMENTS.

The consolidation of indictments for trial is a matter within the sound discretion of the trial court, which will not be interfered with by an ap-

*For other cases see same topic & § NUMBER in Dec. & Am. Digs. 1907 to date, & Rep'r Indexes

pellate court unless it has been abused or manifest injustice has been done.

[Ed. Note.—For other cases, see Criminal Law, Dec. Dig. § 1148.*

Consolidation of, and trial of indictments together, see note to *Campbell v. H. Hackfeld & Co.*, 69 C. C. A. 287.]

7. CRIMINAL LAW (§ 661*)—TRIAL—RECEPTION OF EVIDENCE.

While in the investigation of charges of fraud the latitude of inquiry is wider than is allowed in many other cases, it does not justify, in the admission of evidence, a disregard of the rules of competency or relevancy.

[Ed. Note.—For other cases, see Criminal Law, Dec. Dig. § 661.*]

8. CRIMINAL LAW (§ 419*)—EVIDENCE—HEARSAY.

On the trial of defendants charged with using the mails in the execution of a scheme to defraud, in which it was an important issue whether a bank conducted by defendants and others was honestly operated or merely used as a means for fraudulently obtaining money from innocent persons, an unauthenticated paper purporting to be a copy of a letter written by one unidentified third person to another, and making charges against the solvency and management of the bank, was not competent evidence merely because there was testimony that it had been shown to one of the defendants, and its admission was prejudicial error.

[Ed. Note.—For other cases, see Criminal Law, Cent. Dig. § 973; Dec. Dig. § 419.*]

9. CRIMINAL LAW (§ 419*)—EVIDENCE—HEARSAY.

An affidavit made to obtain an attachment in an action against a bank was inadmissible as evidence of the insolvency of the bank in a criminal case against third parties, there being no proof that a judgment was ever obtained in the action or that return of nulla bona was made by the sheriff.

[Ed. Note.—For other cases, see Criminal Law, Cent. Dig. § 973; Dec. Dig. § 419.*]

10. CRIMINAL LAW (§ 398*)—EVIDENCE—BEST AND SECONDARY.

Where the books of account of a bank were in court in a criminal case and subject to inspection by counsel, it was competent for a witness who was familiar therewith to summarize their contents in his testimony.

[Ed. Note.—For other cases, see Criminal Law, Dec. Dig. § 398.*]

11. WITNESSES (§ 388*)—IMPEACHMENT—INCONSISTENT STATEMENTS.

A written statement previously made by a witness is not admissible in evidence to contradict and impeach his testimony, unless it was called to his attention when on the stand.

[Ed. Note.—For other cases, see Witnesses, Cent. Dig. § 1233; Dec. Dig. § 388.*]

12. POST OFFICE (§ 50*)—OFFENSES AGAINST POSTAL LAWS—TRIAL—INSTRUCTIONS.

Instructions requested by defendants on trial for a fraudulent use of the mails considered, and held properly refused.

[Ed. Note.—For other cases, see Post Office, Dec. Dig. § 50.*]

In Error to the District Court of the United States for the Western District of Arkansas.

Oscar L. Miles, for plaintiffs in error.

Ira D. Oglesby (James K. Barnes, on the brief), for defendant in error.

Before VAN DEVANTER and ADAMS, Circuit Judges, and PHILIPS, District Judge.

*For other cases see same topic & § NUMBER in Dec. & Am. Digs. 1907 to date, & Rep'r Indexes

ADAMS, Circuit Judge. The plaintiffs in error, Lemon and Waller, were indicted for devising a scheme or artifice to defraud, were tried, found guilty and sentenced, and by this writ of error seek a reversal of the judgment against them. There were two indictments, which were consolidated for the purpose of the trial. One contained two and the other three counts, each charging the same general scheme, but charging the mailing of different letters or writings to different persons in the way of executing the scheme. Two other defendants jointly charged with Lemon and Waller were convicted, but, as they are not complaining, our attention is confined exclusively to those named. The several counts of the indictment charge in effect that the defendants, being officers and directors of the Southern Bank & Trust Company, of Ft. Smith, Ark., devised a scheme or artifice to defraud involving the making of false statements of the financial condition of their bank, and sending the same by mail to different persons whom they intended to defraud. The scheme was that they would represent and pretend that they were engaged in the management and conducting of a solvent banking business; that their bank was in a prosperous condition and financially able to respond to the demands of their depositors and customers; that it had capital stock amounting to \$600,000, deposits amounting to \$76,475, loans and discounts amounting to \$393,322.83, stocks and bonds amounting to \$269,520, and other attractive items unnecessary now to mention; that such representations and pretenses were made for the purpose of inducing certain persons named, and others to the grand jurors unknown, to purchase their stock, deposit money with and make loans to them, with the real intent and purpose on their part to convert the money so to be paid, deposited, and loaned to their own use.

The first count, which is fairly representative of all, charges that the defendants, on a given date and at a stated place, "did then and there voluntarily and feloniously devise a scheme and artifice to defraud, and did then and there conspire, combine and agree together to commit the act made an offense by section 5480 of the Revised Statutes of the United States [U. S. Comp. St. 1901, p. 3696]; that is, the said defendants conspired, confederated and agreed together in devising and in intending to devise a scheme and artifice to defraud various persons and companies out of their money," etc. The indictment proceeds with averments constituting equally a description of a scheme to defraud within the purview of section 5480 of the Revised Statutes (U. S. Comp. St. 1901, p. 3696), and a description of a substantive offense required to be pleaded in an indictment for conspiring to commit an offense within the purview of section 5440 (U. S. Comp. St. 1901, p. 3676). The allegations touching the mailing of letters to individuals named served well the double purpose of mailing letters "in and for executing the scheme to defraud" as required by section 5480, and also the purpose of the overt act "to effect the object of the conspiracy" as required by section 5440.

Seventy-four errors were originally assigned, but those relied on for reversal have been appropriately reduced to five. They are as follows: That the court erred (1) in overruling the demurrer to the

indictment and declining to instruct a verdict for defendants; (2) in admitting and excluding evidence over defendants' objection; (3) in making prejudicial remarks in the presence of the jury; (4) in its charge to the jury; and (5) in refusing to charge as requested by defendants. These will be considered in the order mentioned.

Should the demurrer to the indictment or motion for an instructed verdict, both of which present the same questions, have been sustained? It is not necessary to set them out in full. They challenge the sufficiency of the indictment for numerous reasons, which will be noticed as we proceed.

In view of the prominence given in section 5480, as amended by the act of March 2, 1889, c. 393 (25 Stat. 873 [U. S. Comp. St. 1901, p. 3696]), to the scheme or artifice "to sell * * * any counterfeit or spurious coin * * * to obtain money by what is commonly called 'sawdust swindle,' 'bills,' 'paper goods,'" etc., defendants' counsel urge that no offenses different from those just specified are contemplated by the section as amended. In this he is clearly in error. The section starts out: "If any person having devised or intending to devise any scheme or artifice to defraud;" then follows in the disjunctive the specification relied on, denouncing the schemes or artifices to sell or deal in counterfeit or spurious money, etc. There is an obvious difference between schemes to defraud and those to sell or deal in counterfeit money. The one necessarily involves a scheme to defraud some person or persons, while the other may or may not involve such scheme. It may be only a scheme to do an unlawful act in which all concerned knowingly participate. Mr. Justice Gray, speaking for the Supreme Court, in the case of *Streep v. United States*, 160 U. S. 128, 132, 16 Sup. Ct. 244, 246, 40 L. Ed. 365, which concerns the construction and meaning of section 5480 as amended, says:

"The statute in very words as well as in manifest intent applies to any person who devises either a scheme to defraud or a scheme to sell counterfeit money or counterfeit obligations of the United States, provided the scheme is intended to be effected, and is effected, by communications through the post office. This indictment charged not a scheme to defraud, but a scheme to sell counterfeit obligations of the United States; and therefore no proof of a scheme to defraud was necessary to support it."

The amendment of 1889, instead of limiting, expanded the operation of the statute. It brought within its comprehension, in addition to what was there before, the subject of dealing in counterfeit and spurious money and other articles there specified. *Culp v. United States*, 27 C. C. A. 294, 82 Fed. 990; *Milby v. United States*, 57 C. C. A. 21, 120 Fed. 1; *Durland v. United States*, 161 U. S. 306, 313, 16 Sup. Ct. 508, 40 L. Ed. 709.

It is also contended that the indictment is bad (1) because it is not charged that the scheme or artifice as originally designed contemplated the use of the post office establishment of the United States in its execution; (2) because no averment is found in the indictment to the effect that defendants knew of the condition of their bank at the time they are alleged to have devised the scheme to defraud; and (3) because it affirmatively appears from the statements and letters set out in the several counts of the indictment that no fraudulent scheme was

contemplated. These contentions, we think, are without merit. The several counts of the indictment, instead of employing the formula of the statute in describing the scheme and artifice by the use of the words, "to be effected by opening or intending to open correspondence," etc., employ language of similar and equally efficacious import. They contain the following:

"That the post office establishment of the United States was to be used for the purpose of executing such scheme and artifice to defraud as aforesaid pursuant to said design and conspiracy by opening correspondence with * * * and by inciting such persons, * * *" etc.

Again, it is averred, in describing the scheme and artifice to defraud, in substance, that the defendants were to make and circulate through the United States mails a false statement of the financial condition of their bank. These are sufficient averments that the scheme and artifice as originally devised contemplated the use of the post office establishment of the United States to accomplish its purpose. It is not necessary to follow the language of the statute. If the averments bring the charge within the substance and true meaning of the statute, it is sufficient.

There was no need of a definite averment that defendants knew that their bank was insolvent at the time they made the alleged false pretenses concerning it. This is not an action for deceit or a criminal action for making false reports touching the condition of the bank where the scienter is indispensable; but it is a criminal charge, the essential elements of which are (1) the devising of a scheme or artifice to defraud, (2) contemplating the employment of the mail service of the United States in its execution, and (3) the actual employment of the mail service in the execution or attempted execution of the scheme. The scheme as laid in the indictment, stripped of much verbiage, is that the defendants would pretend that they were engaged in a certain solvent banking enterprise, and would hold out and pretend that they had assets in excess of liabilities, and would make other alluring pretenses of like kind, when in fact their pretenses were false and their real purpose was, through and by means of the pretenses, to induce the unwary to deposit money with them and thereby enable them to convert the same to their own use. The averments of the indictment thus epitomized disclose a scheme or artifice well designed and adapted to deceive, and describe it with sufficient certainty to show its existence and character and to fairly acquaint the accused with what they were required to meet. Such, without the certainty and particularity required in describing a substantive offense in a criminal charge, is all that is necessary in stating the first element of the offense denounced by section 5480. *Brooks v. United States*, 76 C. C. A. 581, 146 Fed. 223.

The contention that the statements and letters set out in the several counts of the indictment negative the alleged fraudulent scheme cannot be sustained. The mailing of a letter in the execution or attempted execution of a fraudulent scheme is the gist of the offense denounced by the statute. It is that act, and it alone, which confers jurisdiction upon the courts of the United States to punish devisers of

fraudulent schemes. The letter which is mailed is not required to recite the whole scheme or be in itself effective to execute it. All that is imperatively required is that the letter mailed should be one calculated or designed to aid or assist in the execution or attempted execution of a scheme already devised. Mr. Justice Brewer, in *Durland v. United States*, said:

"We do not wish to be understood as intimating that in order to constitute the offense it must be shown that the letters so mailed were of a nature calculated to be effective in carrying out the fraudulent scheme. It is enough if, having devised a scheme to defraud, the defendant, with a view of executing it, deposits in the post office letters which he thinks may assist in carrying it into effect, although in the judgment of the jury they may be absolutely ineffective therefor."

It is also urged that the indictment is bad for duplicity; that it embodies in one and the same count a charge of devising a scheme to defraud, and of conspiring to do the same thing. A most casual reading of the indictment discloses that both of these charges are made in each and every count of the indictment. They are therefore double, and would have been held bad for duplicity if seasonably challenged on that ground, either by a motion to quash, demurrer, or motion to elect, which are the three approved methods for doing it. Bishop's *New Criminal Procedure*, § 442. The rule against duplicity stands in the law as a privilege which may be invoked or not at the election of the defendants. 1 Bishop's *New Criminal Procedure*, § 442. But the defendants, instead of invoking this privilege, went to trial without objection on this ground, and the court tried the case as a scheme to defraud. It was then too late to raise this objection. It was effectually waived by defendants' conduct. *Morgan v. United States*, 78 C. C. A. 323, 148 Fed. 189.

Objection is made to the consolidation of the two indictments and to the ruling of the court below on defendants' motion to require the government to elect (not on the ground of duplicity, however) under what counts it would go to trial. These matters are confided to the sound discretion of the trial court, with the exercise of which we ought not to interfere except in cases where that discretion has been abused or manifest injustice has resulted. Nothing of that kind appears in this record.

This brings us to a consideration of errors assigned upon the admission and exclusion of testimony. The Old National Bank of Providence, R. I., had loaned \$1,000 to the trust company, and in November, 1905, negotiations were pending for a further loan. Defendant Lemon, who then or soon after became vice president and Eastern representative of the trust company to sell its stock and secure rediscount of its paper, being then at Ft. Smith, undertook to get, and did get, from the trust company a statement of its financial condition for the Providence Bank. Metcalf, the president of that bank, was on the stand as a witness in behalf of the government. He testified that in the progress of negotiations between his bank and the trust company he acquired some information which caused him to hesitate in making the second loan until Lemon should return from Ft. Smith. He testified that Lemon returned soon after, and that he showed him a

paper bearing date November 13, 1905, purporting to be a copy of a communication from "W. H. L." to Mr. Slayden. "W. H. L." was assumed in the conversation between Metcalf and Lemon which followed to stand for W. H. Lastinger, a former cashier of the trust company, and Slayden was assumed to be a member of the firm of S. W. Slayden & Co., of Waco, Tex. There was no showing that the original document was actually written by W. H. Lastinger, or that the copy was a correct transcript of the original. There was no showing as to what Lemon said or did when this copy was shown to him; that is, whether he admitted anything, denied anything, or kept silence. As to these, the record is altogether silent. In this state of the proof the government offered the copy in evidence, and it was admitted over the defendants' objection and exception. It was a lengthy document, and contained reflections of a derogatory character to the trust company; characterized Lemon and others as promoters, aiding the enterprise with "hot air" only; declared the trust company to be in a shaky condition; informed the addressee of the letter, who seems to have been a director in the company, that "W. H. L." had assumed to act for him and had tendered his resignation as such director. This document by direct averment and innuendo conveyed the impression that the bank was unsafe and in an insolvent condition. We are unable to appreciate the attempted justification of this evidence. Neither can we discover any rational ground for its admission. In the investigation of charges of fraud the latitude of inquiry is wider than is allowed in many other cases. This is so because the intent of the parties necessarily involved in a charge of fraud is a mental condition and provable by a variety of acts, declarations, and facts which are often incompetent in the trial of other issues. But this latitude of inquiry does not justify a disregard of the rules of competency or relevancy. Even if we should treat the copy as a properly authenticated original letter written by Lastinger, a former cashier of the bank, which is making an unwarranted concession, there remain insuperable objections to its admissibility in evidence. It is not perceived how it had any tendency to illustrate the intent with which Lemon or anybody else had conducted the business of the trust company. Neither is the pretense that it served the purpose of imparting notice to Lemon of any facts worthy of consideration. The case was a criminal charge for devising a scheme to defraud, and not a civil suit for fraud and deceit in making a statement to secure a loan of money. This fact, as disclosed by many phases of the trial, seems to have been lost sight of or to have been intentionally ignored. The most important issue in the trial was whether the bank had been conducted honestly as a legitimate banking enterprise, or dishonestly as a means for looting the money of innocent patrons. The letter bore directly upon that issue, but it was nothing but hearsay evidence written by a party and to a party not concerned in the case before the court. The supposed Mr. Lastinger was permitted to testify unsworn, and without cross-examination, directly on the most vital issue in the case, and defendants were deprived of their constitutional right to be confronted with the witness against them. The letter was not only read to the jury with

the stamp of the court's approval on it as competent and trustworthy evidence, but the court went further and told the jury in effect that its contents "were binding" on Lemon. The error was a grave one, and necessarily prejudicial. *Nevada Company v. Farnsworth*, 42 C. C. A. 504, 102 Fed. 573.

Again, it is assigned for error that the trial court erred in admitting an affidavit made by one Robert Dawson on March 2, 1906, to secure an attachment of property of the trust company in aid of a suit begun against it that day by him, together with a writ of attachment issued thereon, and the return of the sheriff that he had seized property belonging to the bank to satisfy the demand sued for. The government's counsel contend that the affidavit and proceedings taken thereon constituted some evidence of the insolvency of the trust company. The affidavit, so far as material for the present case, reads as follows:

"Comes now the plaintiff [Dawson] and makes known to the court that the defendant above named [Southern Bank & Trust Company] is indebted to him in the sum of one thousand dollars and interest thereon; * * * that said defendant has sold all its assets or in some other manner disposed of them in fraud of its creditors, and that the former management has left this country for parts unknown," etc.

It is noticeable that the attachment proceedings thus offered in evidence fail to show that any judgment was ever rendered against the trust company, or that any execution was ever issued thereon, or that there was any return of nulla bona by the sheriff. Conceding, without deciding, that, if the proceedings had resulted in a judgment and an execution had issued thereon, a return of nulla bona, being the act of an officer performed in the discharge of his official duty, might have constituted prima facie evidence of insolvency, it is not perceived how the affidavit of a plaintiff made to put the machinery of the courts in motion to collect a demand which may or may not be disputed can constitute any evidence in another action between different parties of any of the facts sworn to. The affidavit, taken by itself or in connection with the seizure, and return, was hearsay evidence of the most damaging character. Like the Lastinger letter, its contents bore directly upon the foremost issue in the case—that of the honesty or dishonesty with which the affairs of the trust company had been conducted. It bore the impressive stamp of verity imparted to it by the jurat attached, and naturally was accorded weight and importance by the jury. Like the Lastinger letter, it enabled the government to secure the testimony of Dawson on the vital issue involved without affording the defendants either the right to be confronted with him or to cross-examine him as a witness. Its admission involved a total disregard of fundamental safeguards to truth, and constituted a plain error, prejudicial to defendants' rights.

Ira D. Oglesby, who had been appointed receiver of the assets of the trust company and who had familiarized himself with its books of account and the value of its assets, was introduced as a witness on behalf of the government. The books of account were in court, and subject to the inspection and use of the defendants' counsel. In such circumstances it was not error to permit the receiver to summarize the

contents of the books. Wigmore on Evidence, vol. 2, § 1230. To require the reading of the entire mass to the jury would have been inconvenient and profitless. The defendants' rights were sufficiently safeguarded by the presence of the books in court and by the right to use them freely in cross-examination.

Witness Oglesby had testified at length concerning the value of the assets of the trust company. It was brought out on cross-examination that he had attached to one of his reports as receiver a statement made by him of assets and liabilities. This statement was offered in evidence by defendants, and excluded by the court on objection made by the government. It was relevant only for the purpose of impeaching the witness by proof of contradictory statements theretofore made by him. Apart from this purpose, it was clearly incompetent. The long-recognized rule is that before evidence of self-contradictory declarations or statements can be introduced for the purpose of impeachment the witness must first be fairly warned of the purpose. His attention must be definitely called to the declaration claimed to be contradictory, and to the time and place, when and where it was made. If when thus fairly warned the witness denies making the declaration, it may be introduced in evidence, not as substantive proof of the facts stated, but to contradict or neutralize the testimony given in chief. The record fails to show that the attention of the witness was called directly to any items or phases of the statement claimed to be contradictory, or that he was asked whether he made such statements, or that he denied doing so. In view of these facts, there was no error in excluding the statement. It was not in itself substantive evidence of the value of the assets, and could be made competent only by a more definite warning of the witness of the contemplated purpose.

Error is assigned upon remarks of the court during the progress of the trial, and other conduct claimed to have been prejudicial to defendants. Attention is called to the following instances as examples: Defendants' counsel offered a letter in evidence, to which the government's counsel objected. The court in ruling said: "I do not see its materiality in any way, but I will let you read it." Again defendants' counsel asked a question, to which objection was interposed by counsel for the government. The court sustained the objection. Counsel for defendants said: "We desire to save our exception, your honor." Whereupon the court responded: "Well, go ahead and save it. You have more of that in this case than anything else anyhow." Again, objection was made to a question propounded by defendants' counsel. The court in overruling the objection said: "I have no objection to that except the waste of time." These and other like remarks of the trial judge are claimed to have disparaged and belittled counsel's honest efforts in behalf of his clients, and it is claimed that the minds of the jury, generally prone to approve and act upon suggestions of the court, were unduly and prejudicially affected by them. As the judgment must be reversed for other reasons, we find no occasion to rule specifically on this assignment of error. A mere reference to the complaint made will, we are confident, be a sufficient caution

to the learned trial judge, distinguished for his general fairness and impartiality, to secure a fair and dispassionate second trial.

Requests for instructions were made by defendants' counsel and refused by the court, and upon these error is predicated. Many of the requests were based on the theory that the indictment was solely for a conspiracy to commit the offense denounced by section 5480, and embraced propositions of law applicable to that theory only. They, for reasons already pointed out, were properly refused. Others, in so far as they stated correct propositions of law applicable to the case, were substantially given in the oral charge and required no repetition. The following instruction was asked by defendants' counsel:

"One of the material averments contained in the indictment against these defendants is that the Southern Bank & Trust Company on the days named in said indictments was insolvent. If, therefore, you do not find from the evidence in this case beyond a reasonable doubt that the Southern Bank & Trust Company was insolvent on the dates of the statements introduced in evidence, you will find the defendants not guilty."

The refusal of the court to give this instruction is urged for error. There are two reasons why it was properly refused: It did not embrace the entire scheme to defraud as laid in the indictment. That scheme was not merely that the defendants would pretend that the trust company was solvent, but would pretend that it had assets largely in excess of its liabilities, and thereby more successfully induce others to deposit money with and make loans to it. The state of solvency merely would not have negatived the existence of this other feature of the scheme laid in the indictment to pretend that the trust company had assets largely in excess of its liabilities. This last-mentioned pretense manifestly would be more persuasive and more likely to succeed than a scheme to pretend that the company was merely solvent. Again, the requested instruction declared that, if the jury did not find the trust company to have been insolvent on the dates of the statements introduced in evidence, they would find the defendants not guilty. That was obviously an incorrect limitation as to time. Non constat some of the statements might have been made to effectuate the scheme or artifice to defraud after the same was devised. The charge was devising a scheme to defraud, and nothing less on this issue than a failure to find that such a scheme was devised warranted a conclusive direction to find a verdict of not guilty. Whether the trust company was insolvent at the time of the alleged devising of the scheme was an important evidential fact in the case. The instruction in question gave to it a conclusive legal effect on the issue of guilt, and was properly refused.

Other assignments of error were argued to us, but as the judgment must be reversed for reasons stated, and as we have sufficiently indicated our views on questions likely to arise on the next trial, we refrain from extending this opinion farther.

The judgment is reversed, and the cause remanded for a new trial.

INDIANA & ARKANSAS LUMBER & MFG. CO. et al. v. BRINKLEY.

DEUTSCH v. SNOWDEN et al.

(Circuit Court of Appeals, Eighth Circuit. October 28, 1908.)

Nos. 2,751, 2,752.

1. JUDGMENT (§ 17*)—PROCESS TO SUSTAIN—JURISDICTION OF PERSON—WARNING ORDER TO "HEIRS OF DECEASED PERSON" INEFFECTUAL TO ACQUIRE IN ABSENCE OF STATUTE.

A decree in a suit in personam against heirs of a deceased person without giving their names in the complaint or warning order is beyond the jurisdiction of a court, and void in the absence of legislative authority for such a proceeding.

[Ed. Note.—For other cases, see Judgment, Cent. Dig. §§ 25, 31; Dec. Dig. § 17.*]

2. PROCESS (§ 100*)—DECREE UPON CONSTRUCTIVE SERVICE VOID IF CONDITION OF LEGISLATIVE AUTHORITY NOT FULFILLED.

Where a statute authorizes the issue and service, by publication, of a warning order to unknown heirs when the fact appears in the complaint that the names of such heirs are unknown to the plaintiff, an averment in the complaint to that effect is indispensable to the validity of such an order and service, and a decree based upon them in its absence is without the jurisdiction of the court and void.

[Ed. Note.—For other cases, see Process, Cent. Dig. § 127; Dec. Dig. § 100.*]

3. JUDGMENT (§ 489*)—COLLATERAL ATTACK FATAL WHERE RECORD DISCLOSES JURISDICTIONAL DEFECT.

While the presumption of the jurisdiction of a court and of the regularity of the proceedings in a court of general jurisdiction protects its judgments from collateral attack, when the record is silent regarding alleged defects, there is no room for that presumption, it does not arise, and its judgment or decree is void upon collateral attack where the record itself discloses lack of jurisdiction.

[Ed. Note.—For other cases, see Judgment, Cent. Dig. §§ 924, 925; Dec. Dig. § 489.*]

4. LIMITATION OF ACTIONS (§ 19*)—STATUTE PROTECTING PURCHASERS AT JUDICIAL SALES INEFFECTUAL WHERE COURT HAD NO JURISDICTION TO MAKE THEM.

A statute which limits the time within which suits against purchasers at judicial sales to recover lands may be brought to five years after the dates of the sales is inapplicable to cases in which the courts which ordered the sales never acquired any jurisdiction to make them.

[Ed. Note.—For other cases, see Limitation of Actions, Cent. Dig. § 73; Dec. Dig. § 19.*]

5. EQUITY (§ 87*)—LACHES—NONE WITHIN TIME OF ANALOGOUS STATUTE OF LIMITATIONS AT LAW IN ABSENCE OF EXTRAORDINARY CIRCUMSTANCES—INCREASE OF VALUE NOT SUCH A CIRCUMSTANCE.

Under ordinary circumstances a suit in equity will not be stayed for laches before, and will be stayed after, the time fixed by the analogous statute of limitations at law. But if unusual conditions or extraordinary circumstances make it inequitable to allow the prosecution of a suit after a briefer, or to forbid its maintenance after a longer, period than that fixed by the statute, the chancellor will not be bound by the statute, but will

*For other cases see same topic & § NUMBER in Dec. & Am. Digs. 1907 to date, & Rep'r Indexes

determine the extraordinary case in accordance with the equities which condition it.

Merely increase in the value of property involved is not such an extraordinary circumstance as will induce a departure from the analogous statute of limitations.

[Ed. Note.—For other cases, see Equity, Cent. Dig. § 242; Dec. Dig. § 87.*]

(Syllabus by the Court.)

Appeal from the Circuit Court of the United States for the Eastern District of Arkansas.

H. F. Roleson, S. H. Mann, and N. W. Norton, for appellants.
T. E. Hare, for appellees.

Before SANBORN and HOOK, Circuit Judges, and AMIDON, District Judge.

SANBORN, Circuit Judge. On December 26, 1905, Robert C. Brinkley exhibited his bill in the court below to remove from his title to certain lands in St. Francis Levee District in the state of Arkansas the alleged cloud created by a sale of them made by the St. Francis Levee District on September 1, 1899, by virtue of a decree to enforce the payment of levee assessments that had been theretofore rendered by the chancery court of St. Francis county. The defendants, the Indiana & Arkansas Lumber & Manufacturing Company and Albert Deutsch, answered that the complainant was entitled to no relief because his title to the lands had been sold to John Parham in 1884 under a decree of the chancery court of St. Francis county rendered by consent of the complainant on October 22, 1883, and because that title had been sold by the St. Francis Levee District in 1899 under the decree to enforce the collection of assessments for the levee. The court below found that there was no evidence of the alleged sale to Parham, that the suit against the complainant and his predecessors in title to sell the land for the levee assessments was without the jurisdiction of the court and void, and it rendered a decree for the complainant from which the defendants have appealed.

Robert C. Brinkley was the owner of the lands in controversy on November 28, 1878, when he died. The title then descended to his children, one of whom was the complainant. In May, 1895, this title was conveyed to Hugh Brinkley, as trustee for the complainant, and this trustee died in 1904, so that the question in the case is whether a superior title was acquired by the defendants by virtue of the tax and assessment proceedings under which they claim the property.

The first specification of error is that the court was mistaken in holding that there was no evidence that the lands were sold to John Parham under the consent decree of the St. Francis circuit court of December 22, 1883, known as the "overdue tax decree," but no evidence of such a sale has been pointed out in the brief or argument of counsel for appellant, and no substantial evidence thereof has been found in the record. All the other specifications challenge the finding

*For other cases see same topic & § NUMBER in Dec. & Am. Digs. 1907 to date, & Rep'r Indexes

of the court that the alleged title under the sale for the levee assessments was void, and this is the real question in the case. The proceeding for that sale was commenced on February 8, 1895, and was governed by the act of the Legislature of Arkansas of February 15, 1893 (Acts Ark. 1893, p. 24), before that act was amended by the act of April 2, 1895 (Acts Ark. 1895, p. 88).

The proceeding under the act of 1893, before its amendment, was not a proceeding in rem, or a proceeding in the nature of a proceeding in rem, as were the proceedings under the amendment of the act which were considered in *Ballard v. Hunter*, 204 U. S. 241, 27 Sup. Ct. 261, 51 L. Ed. 461, Id., 74 Ark. 174, 85 S. W. 252, but it was a suit in chancery in personam and it bound only the parties to it. *Updegraff v. Marked Tree Lumber Co.*, 83 Ark. 154, 103 S. W. 606, 607; *Wilson v. Gaylord*, 77 Ark. 479, 92 S. W. 26. The act of 1893 provided that the board of directors of St. Francis Levee District should be a body politic and corporate, and by that name might sue and be sued, that it might make assessments upon lands within the district for the purpose of constructing a levee, that it might elect a collector, that the collector might enforce payment of the assessments by suits in chancery, that persons having an interest in the lands should be bound by the judgments and decrees therein in the same manner as in other chancery suits, and that the suits "should be conducted in the name of St. Francis Levee District and in accordance with the practice and proceedings of chancery courts." Sections 11, 12, and 13. The general statutes of Arkansas prescribed the method of commencing and carrying forward suits in chancery in that state, and the provisions pertinent to the issues in this case were: The suit shall be commenced by filing a complaint and causing a summons to be issued. *Mansfield's Digest of the Laws of Arkansas*, § 4967. Where it appears by the affidavit of the plaintiff filed in the clerk's office at or after the commencement of the action that the defendant is a nonresident of the state, the clerk shall make an order on the complaint warning such defendant to appear in the action within 30 days from the time of making the order. Section 4989. Where in an action against the heirs of a person deceased, as unknown heirs, or against other persons made defendants, as unknown owners of property to be divided or disposed of in the suit, it appears by the complaint that the names of such heirs, or any of them, or of such other persons, are unknown to the plaintiff, the warning order, as directed by the last section, shall be made by the clerk against such unknown heirs or owners. Section 4991. Warning orders shall be published weekly for at least four weeks. Section 4990. A defendant against whom a warning order has been made and published shall be deemed to be constructively summoned on the thirtieth day after the making of the order, and the action may proceed accordingly. Section 4992. Before judgment is rendered against a defendant constructively summoned, it shall be necessary that an attorney be appointed at least 60 days before the judgment is rendered to defend for the defendant and inform him of the action and of such other matters as may be useful to him in preparing for his defense. The attorney may be appointed by the clerk when the warning order is made, or by the court, and

shall receive a reasonable compensation for his services, to be paid by the plaintiff and taxed in the costs. Section 5190.

The suit to enforce the payment of the assessments for the levee, so far as it is necessary to set it forth, ran in this way: On February 8, 1895, there was filed in the chancery court of St. Francis county a complaint entitled "W. R. Kendrick, as Collector for and in behalf of St. Francis Levee District, Plaintiff, v. Brinkley Heirs, Heirs of R. C. Brinkley, Deceased, Defendants," in which the plaintiff averred that the following lands belonging to the defendants, "see list for 1893 and 1894 pasted hereon as part hereof," were assessed and taxes thereon were levied for levee purposes, that the taxes had not been paid, "that the defendants, the Brinkley heirs, heirs of R. C. Brinkley, dec., are nonresidents of the state of Arkansas," and prayed for a sale of the lands to pay the taxes. On the same day the clerk indorsed a warning order upon the complaint to "Brinkley heirs, heirs of R. C. Brinkley, dec.," and appointed S. H. Mann attorney ad litem for them, who on March 18, 1895, reported that the place of residence of the defendants was unknown to him, that he had made inquiry but had not been able to ascertain same, and therefore he had not communicated with them. A warning order entitled "W. R. Kendrick, as Collector for and in behalf of St. Francis Levee District, Plaintiff, v. Unknown Heirs of R. C. Brinkley, Dec'd, Defendants," directed to "the defendants, heirs of R. C. Brinkley, dec'd," was published. There was no description of any of the lands in the warning order and none in the complaint, unless the list of lands which the clerk found folded in the complaint detached was once pasted or attached to it. The jurisdiction of the chancery court of St. Francis county to render the decree against the complainant and his predecessors in interest was challenged, (1) because no warning order directed to any of them was ever made or published, (2) because no suit was brought "in the name of St. Francis Levee District" (section 13, Act 1893), and (3) because there was no description of the lands in the complaint or in the warning order.

The basic principle of the jurisprudence of the English-speaking nations is that no person shall be deprived of his life, liberty, or property without due process of law; that is to say, without notice and an opportunity to be heard before the decision respecting the justice of the disposition of his life, liberty, or property that is sought. Const. U. S. Amend. 14; Const. Ark. art. 2, § 21; 2 Kent's Comm. 13; *Alexander v. Gordon*, 101 Fed. 91, 96, 98, 41 C. C. A. 228. In the absence of legislative power to proceed otherwise, there is but one way to make a person a party to a suit or to direct to him an adequate notice of a proceeding to deprive him of his property or to bring his person within the jurisdiction of a court, and that is to direct the notice to him by his name and to serve it upon him in person. And where the authority is granted by a statute to notify him otherwise on certain conditions, those conditions must be fulfilled, the method prescribed must be substantially followed or the court fails to obtain jurisdiction of his person, and its decree against him is ineffectual and void. There was a provision of the statutes of Arkansas that, upon condition that it appeared in the complaint that the heirs of a

deceased person or the owners of property to be disposed of in a suit were unknown, a warning order might be made by the clerk against such unknown heirs or owners. But there was no other provision in the legislation of Arkansas whereby the heirs of a deceased person might be brought within the jurisdiction of one of its courts in a personal action without making them parties to the suit by name. The expression of one method of obtaining constructive service of such parties is the exclusion of all others, and this legislation was a denial of authority to obtain jurisdiction of unknown heirs or owners by constructive service in any other way than that there prescribed. The plaintiff in the suit to enforce the levee assessment either knew, or he did not know, who the heirs of R. C. Brinkley were. If he knew, there was but one way in which he could bring them within the jurisdiction of the court, and that was by making them defendants by their true names both in his complaint and in his warning order, and by directing the order to them by those names, for there was no authority granted by statute, by the common law, or by the practice of the courts to obtain jurisdiction of a defendant, whose name was known, in a personal suit in any other way. There was no statutory or other authority to obtain jurisdiction of such a defendant in a personal suit by publishing a notice to a class of which he might be a member without naming him. If, on the other hand, the plaintiff did not know the names of those heirs, there was only one way in which he could bring them within the jurisdiction of the court, and that was by averring that fact in his complaint and procuring a warning order directed to them as unknown heirs. He pursued neither course. He did not make the defendant, or the other heirs of R. C. Brinkley, deceased, defendants by their names, and the court acquired no jurisdiction of them if their names were known to him, and he did not allege in his complaint that their names were unknown to him, and the court acquired no jurisdiction of them if their names were not known to him. The inevitable conclusion is that where, in a suit in personam in chancery, the only authority to obtain jurisdiction of persons by publishing a warning order directed to heirs of a deceased person without naming them is conditioned by the appearance in the complaint of the averment that their names are unknown, the court acquires no jurisdiction of them by the issue and publication of such an order in the absence of the requisite averment.

Counsel for the appellants rely upon *Huling v. Kaw Valley Railway & Improvement Co.*, 130 U. S. 559, 9 Sup. Ct. 603, 32 L. Ed. 1045, and *Ballard v. Hunter*, 204 U. S. 241, 262, 27 Sup. Ct. 261, 51 L. Ed. 461, to sustain the service of the warning order in this case. But those were suits in the nature of proceedings in rem in which the land and not the person was the real defendant. The case last cited arose under the amendment of the act of 1893 (Acts 1895, p. 88), which was made for the purpose of transforming the proceeding from a suit in chancery to a proceeding in rem, and which provided that the subsequent proceedings under that amendment should be entitled "*St. Francis Levee District v. Delinquent Lands*," that a notice of the suit, which should contain a description of the lands and should be

addressed to the parties named therein "and all others having or claiming an interest in the following described lands," should be published, and that the proceedings and judgment "should be in the nature of proceedings in rem." No such provisions can be found in the original act of 1893, which controls this case. There was no such notice in the original suit here in question. The lands were not described in the warning order which was published, and there was no description of them in the complaint, unless the folded list found in the complaint but not attached thereto was originally a part of it. The proceeding to enforce the assessments for the levee in this case was a mere chancery suit in personam, and it is governed by the basic principles of law to which we have adverted, and not by the decisions cited, which treat of proceedings in the nature of proceedings in rem and not of personal suits in chancery.

Attention is called to a provision of section 13 of the act of 1893 which reads "that no informality or irregularity in holding the meetings, or in the description or valuation of the lands, or in the name of the owners or the numbers of acres therein, shall be a valid defense to such action." But this enactment manifestly relates to the defense to the original action in the state court to enforce the assessment, not to suits of the nature here pending to challenge the jurisdiction of that court to render its decree, and it is ineffectual to confer upon the chancery court of St. Francis county jurisdiction of a person who was never made a party to the suit before it or served with summons, notice, or warning order in it.

On the day when the complaint in the original suit was filed the clerk appointed one Mann attorney ad litem for the defendants; but the statute provided that this appointment should be made for defendants constructively served with the warning order, and, as the complainant and his predecessors in interest were never parties, never defendants, never within the jurisdiction of the chancery court of St. Francis county in that state, the appointment and the action of that attorney were without authority and ineffectual.

Counsel invoke the presumption in favor of the regularity of the proceedings of a court of general jurisdiction which protects its decrees against collateral attack where its record is silent regarding alleged defects, but there is no room for presumptions where the crucial facts appear upon the face of the record, and this presumption does not arise where the record itself discloses a fatal lack of jurisdiction. The complaint in the suit to enforce the assessments is before us, and it contains no averment that the names of the heirs of Brinkley were unknown to the plaintiff. The decree in that case is therefore void on its face, both against direct and against collateral attack, and it must be disregarded. *Johnson v. Hunter*, 147 Fed. 133, 137, 77 C. C. A. 359, 363; *Galpin v. Page*, 18 Wall. 350, 366, 21 L. Ed. 959; *Settlemier v. Sullivan*, 97 U. S. 444, 448, 24 L. Ed. 1110; *Parr v. Matthews*, 50 Ark. 390, 393, 8 S. W. 22; *Cross v. Wilson*, 52 Ark. 312, 12 S. W. 576; *Martin v. McDiarmid*, 55 Ark. 213, 216, 17 S. W. 877; *Gregory v. Bartlett*, 55 Ark. 30, 35, 17 S. W. 344; *Dick v. Foraker*, 155 U. S. 404, 15 Sup. Ct. 124, 39

L. Ed. 201; *Barber v. Morris*, 37 Minn. 194, 33 N. W. 559, 5 Am. St. Rep. 836; *Murphy v. Lyons*, 19 Neb. 689, 28 N. W. 328; *Ely v. Tallman*, 14 Wis. 28; *Clark v. Thompson*, 47 Ill. 25, 95 Am. Dec. 457. It is not necessary to consider the other objections to the decree, for the court below held it void, and, as its decision was right, it could not be reversed even if it were founded on a wrong reason.

This suit was not brought until more than five years after the sale of the land under the decree, and counsel invoke section 5060 of Kirby's Digest of the Laws of Arkansas, which limits the time within which a suit against a purchaser, his heirs or assigns, for the recovery of lands sold at a judicial sale, may be brought, to five years after the sale. But a judicial sale is one made by direction of a court or judge who has lawful authority to cause it to be made. This sale was not a judicial sale, because the chancery court of St. Francis county never had jurisdiction of the heirs of R. C. Brinkley, or of their title to the land, and hence never had lawful authority to sell it. The statute of limitations here cited governs proceedings against purchasers at sales by direction of a court which has acquired lawful authority to order them, but it is ineffectual to validate or protect sales directed by a court which was without jurisdiction or lawful power to make them. *Alexander v. Gordon*, 101 Fed. 91, 97, 41 C. C. A. 228; *Pursley v. Hayes*, 22 Iowa, 11, 25, 92 Am. Dec. 350; *Boyles v. Boyles*, 37 Iowa, 592; *Good v. Norley*, 28 Iowa, 188; *Rankin v. Miller*, 43 Iowa, 11, 21; *Feller v. Clark*, 36 Minn. 338, 340, 31 N. W. 175; *Kipp v. Fernhold*, 37 Minn. 132, 134, 33 N. W. 697; *Baker v. Kelley*, 11 Minn. 480 (Gil. 358); *Smith v. Kipp*, 49 Minn. 119, 125, 51 N. W. 656.

Finally, counsel contend that the complainant was guilty of laches which should prevent his recovery. But an action at law to recover the property would not have been barred in less than seven years. Kirby's Digest, § 5056. The land was wild and unoccupied. No one took possession or asserted title to it adverse to the complainant until the lumber company bought its alleged title under the decree for the levee assessment in 1899, and this suit was brought in 1905. The established rule for the administration of the doctrine of laches in equity is that under ordinary circumstances a suit in equity will not be stayed before, and will be stayed after, the time fixed by the analogous statute of limitations at law. But if unusual conditions or extraordinary circumstances make it inequitable to allow the prosecution of a suit after a briefer, or to forbid its maintenance after a longer, period than that fixed by the statute, the chancellor will not be bound by the statute, but will determine the extraordinary case in accordance with the equities which condition it. *Kelley v. Boettcher*, 29 C. C. A. 14, 21, 85 Fed. 55, 62, and cases there cited; *Billings v. Smelting Company*, 2 C. C. A. 252, 262, 263, 51 Fed. 338, 349; *Bogan v. Mortgage Company*, 11 C. C. A. 128, 135, 63 Fed. 192, 199. No extraordinary circumstances or unusual conditions, except that between 1895 and 1905 the land increased in value from a few cents to \$7 an acre, have been suggested. While a striking change in value is always to be considered, the mere fact that there has been a great appreciation or

depreciation after the defendants acquired their claim and before the suit was brought is not ordinarily sufficient, and is not sufficient in this case, to turn aside the ordinary course of judicial proceedings. There are no rights of innocent purchasers, no expensive improvements made by them in reliance upon their purchases, no loss of muni- cements of title to appeal to the conscience of a chancellor, and the complainant's equitable right to remove the cloud he assails has not been lost by laches.

The decree of the court below must be affirmed, and it is so ordered.

GOODMAN v. CITY OF FT. COLLINS.

(Circuit Court of Appeals, Eighth Circuit. November 6, 1908.)

No 2,634.

1. **EMINENT DOMAIN (§ 194*)—COLORADO STATUTE—PLEADINGS—JURISDICTIONAL ALLEGATIONS—AMENDMENT.**
 In condemnation proceedings in the county courts of Colorado under the statute of that state, the complaint, if wanting in the requisite jurisdictional allegations, is not entirely void but amendable, and the requisite amendment, if allowed and made, relates back to the time of filing the complaint.
 [Ed. Note.—For other cases, see Eminent Domain, Cent. Dig. § 523; Dec. Dig. § 194.*]
2. **PROCESS (§ 66*)—PROCESS UPON DEFECTIVE COMPLAINT.**
 A summons which is otherwise duly issued and served, is not void merely because it is issued upon a complaint which is wanting in the requisite jurisdictional allegations—the same being amendable—or because a copy of the defective complaint is attached to the summons as issued and served.
 [Ed. Note.—For other cases, see Process, Cent. Dig. § 53; Dec. Dig. § 66.*]
3. **PROCESS (§ 68*)—PERSONAL SERVICE IS EQUIVALENT OF APPEARANCE.**
 Due personal service of a summons brings a respondent before the court for all purposes of the proceeding as fully as would a voluntary appearance.
 [Ed. Note.—For other cases, see Process, Dec. Dig. § 68.*]
4. **PROCESS (§ 6*)—AMENDED COMPLAINT—NEW PROCESS NOT REQUIRED.**
 When respondents have been brought under the jurisdiction of the court by proper service of process, the jurisdiction over them is not lost by an amendment of the complaint whereby a necessary jurisdictional allegation is inserted in it. The amendment is not the institution of a new proceeding, and creates no occasion for the issuance of a new summons or like process.
 [Ed. Note.—For other cases, see Process, Cent. Dig. § 5; Dec. Dig. § 6.*]
5. **JUDGMENT (§ 503*)—COLLATERAL ATTACK—MERE ERROR NOT SUFFICIENT.**
 A judgment is not open to collateral attack merely because there may have been an abuse of discretion in the exercise of a lawful power to allow amendments to the complaint, for at most that would be a mere error and would not render the judgment void.
 [Ed. Note.—For other cases, see Judgment, Cent. Dig. § 943; Dec. Dig. § 503.*]

(Syllabus by the Court.)

In Error to the Circuit Court of the United States for the District of Colorado.

Richard McKnight, for plaintiff in error.

Paul W. Lee (Cornelius Ferris, Jr., on the brief), for defendant in error.

Before SANBORN and VAN DEVANTER, Circuit Judges, and PHILIPS, District Judge.

VAN DEVANTER, Circuit Judge. This was an action in ejectment wherein there were opposing contentions respecting the effect to be given to a prior judgment apparently investing the defendant with the title and right of possession to the premises in controversy. The judgment was rendered in a condemnation proceeding in one of the county courts in Colorado, which are concededly without jurisdiction where the value of the property involved exceeds \$2,000. Const. Colo. art. 6, § 23. A statute declares that, "to give the said courts jurisdiction," the complaint shall state that the value of the property involved does not exceed the jurisdictional limitation. 1 Mills' Ann. St. Colo. §§ 1054, 1055. Here the original complaint, although otherwise sufficient, was silent as respects the value of the property involved, but in the course of the proceeding it was amended, by the leave of the court, by inserting the requisite jurisdictional allegation. When it was filed a proper summons was duly issued, and personal service thereof was duly made on the respondents, but they did not appear. Although not required by statute (1 Mills' Ann. St. §§ 1717, 1718; Mills' Ann. Code, § 34; Seeley v. Taylor, 17 Colo. 70, 79, 28 Pac. 461, 723; Burkhardt v. Haycox, 19 Colo. 339, 35 Pac. 730), a copy of the complaint was attached to the summons as issued and served. No summons or "process of any kind or character" was issued or served after the complaint was amended. The amount of the award of the commissioners, which was given effect by the judgment, was well within the jurisdictional limitation. Upon these facts, it is insisted that the county court was without jurisdiction to render the judgment (a) because, in the absence from the original complaint of the requisite jurisdictional allegation, the complaint and the summons issued and served were entirely void; (b) because, in the absence of a voluntary appearance by the respondents, the court was without any power to permit the amendment of the complaint; and (c) because the amendment was in effect the institution of a new proceeding, and, in the absence of a voluntary appearance by the respondents, a new summons or other notice having "the substantial characteristics of a summons" was essential to bring them into court in that proceeding. The insistence cannot be sustained, either in whole or in part, and for these reasons: Another statute regulatory of the practice in condemnation proceedings, and standing upon an equal footing with the one requiring the jurisdictional allegation, expressly declares that "amendments to the petition, or to any paper or record in the cause, may be permitted whenever necessary to a fair trial and final determination of the questions involved" (1 Mills' Ann. St. § 1719) and the Supreme Court of the state has said of this provision:

"It will be observed that no particular method of amending the petition is pointed out; that no specified steps are essential as a prerequisite to the allowance of such amendments. * * * The whole matter was largely discretionary with the court, and there was no such abuse of discretion as calls for interference." *Knoth v. Barclay*, 8 Colo. 300, 302, 6 Pac. 924.

Such statutes are rightly accorded a liberal, as distinguished from a restrictive, interpretation, and are almost uniformly held to be as applicable to the correction of errors and omissions in the statement of jurisdictional facts as to the correction of other defects. *Linhart v. Buiff*, 11 Cal. 280; *Coolman v. Fleming*, 82 Ind. 117, 121; *Mitchell v. Mo. Pac. Ry. Co.*, 82 Mo. 106; *McLellan v. Crofton*, 6 Greenl. (Me.) 307, 328; *Continental Ins. Co. v. Rhoads*, 119 U. S. 237, 7 Sup. Ct. 193, 30 L. Ed. 380; *Halsted v. Buster*, 119 U. S. 341, 7 Sup. Ct. 276, 30 L. Ed. 462; *Bowden v. Burnham*, 59 Fed. 752, 8 C. C. A. 248; *Carnegie, Phipps & Co. v. Hulbert*, 70 Fed. 209, 16 C. C. A. 498; *Whalen v. Gordon*, 95 Fed. 305, 37 C. C. A. 70; *In re Plymouth Cordage Co.*, 135 Fed. 1000, 68 C. C. A. 434. And this is the settled rule of decision in the courts of Colorado. *Archibald v. Thompson*, 2 Colo. 388; *Lebanon Mining Co. v. Consolidated Co.*, 6 Colo. 371; *Jordan v. Greig*, 33 Colo. 360, 378, 80 Pac. 1045; *Southwestern Land Company v. Hickory Jackson Ditch Company*, 18 Colo. 489, 33 Pac. 275. In the last case the court disposed of a contention similar to that now under consideration by saying:

"The petition originally filed was defective in not averring that the amount of damages, if any, to the residue of respondent's property, and the value of the strip of land sought to be taken, were within the jurisdiction of the county court; and counsel for respondent insist that, the jurisdictional averment being insufficient, the court had no power to grant leave to amend. With this we cannot agree. The defect might have been cured by amendment, if the petition had been attacked by demurrer. By section 50 of the Code of Civil Procedure, a want of jurisdiction of 'the subject-matter of the action' is made a ground of demurrer. Section 74 provides that, if a demurrer is sustained, 'the unsuccessful party shall plead over or amend, upon such terms as shall be just.' The motion to dismiss in this case upon the grounds stated was the equivalent of a demurrer, and we can perceive no reason why the amendment might not be made upon proper terms as well as upon demurrer."

A complaint which is defective, but amendable, cannot be regarded as entirely void (*Archibald v. Thompson*, 2 Colo. 388, 391); nor can a summons be so regarded merely because it is issued upon such a complaint. It is of no importance that a copy of the original complaint was attached to the summons as served upon the respondents, because they were bound to take notice of the statute relating to amendments, and, if they chose to act on the assumption either that the plaintiff would not seek an amendment or that the court would not permit one, they did so at their peril. *Granger v. Judge*, 44 Mich. 384, 6 N. W. 848; *Griffin v. McGavin*, 117 Mich. 372, 75 N. W. 1061, 72 Am. St. Rep. 564. Nor was the power of the court to allow the amendment affected in any wise by their failure to appear, because the personal service of the summons brought them under the jurisdiction of the court for all purposes of the proceeding as fully as a voluntary appearance could have done. *Langmaid v. Puffer*, 7 Gray (Mass.) 378, 382; *Bond v. Howell*, 11 Paige (N. Y.) 233; *Sidway v. Marshall*, 83 Ill. 438; *Chicago, etc., Co. v. Johnston*, 89 Ind. 88; *Yonge v. Broxson*, 23

Ala. 684; *Phelps v. Smith*, 16 W. Va. 522. That jurisdiction was not lost by the amendment. It was not the institution of a new proceeding, and created no occasion for the issuance of a new summons or like process. *Bond v. Howell*, supra; *Healy v. Aultman & Co.*, 6 Neb. 349; *Schuyler Nat'l Bank v. Bollong*, 28 Neb. 684, 692, 45 N. W. 164; *Haynes v. Rice*, 33 Tex. 167; *St. Louis v. Gleason*, 15 Mo. App. 25, 29; *Phelps v. Smith*, supra; 1 Enc. Pl. & Pr. 494; 19 Id. 573. The insistence to the contrary is rested upon the theory that the amendment could only operate prospectively, and therefore that all that was done prior thereto was void. But this theory is a mistaken one, as is well shown in *Bowden v. Burnham*, supra, where it was said by Judge Caldwell, in speaking for this court:

"The objection to the jurisdiction of the court is grounded on the fact that the original petition did not disclose that the assignors of the claims which the plaintiffs sued on as assignees were citizens of states other than Kansas, and the further fact that, rejecting those claims, the amount claimed by the plaintiffs was less than \$2,000. But the court very properly granted the plaintiffs leave to amend their complaint (section 954, Rev. St. U. S. [U. S. Comp. St. 1901, p. 696]), and it was amended. Nevertheless, the plaintiff in error asserts that as the complaint, at the time the attachment was issued, did not contain the necessary jurisdictional averments, every step taken in the cause prior to the amendment was void, and that the amendment of the complaint could not impart vitality or validity to anything done before the amendment was made. This contention is wholly untenable. It is everyday practice to allow amendments of the character of those made in this case, and when they are made they have relation to the date of the filing of the complaint or the issuing of the writ or process amended. When a complaint is amended, it stands as though it had originally read as amended. The court in fact had jurisdiction of the cause from the beginning, but the complaint did not contain the requisite averments to show it. In other words, the amendment did not create or confer the jurisdiction; it only brought on the record a proper averment of a fact showing its existence from the commencement of the suit."

To the same effect are *Miller v. Cook*, 135 Ill. 190, 203, 25 N. E. 756, 10 L. R. A. 292; *Norris v. Ile*, 152 Ill. 190, 203, 204, 38 N. E. 762, 43 Am. St. Rep. 233; *Towns of Windham and Chaplin v. Litchfield*, 22 Conn. 226, 232; *Hoyt v. Smith*, 28 Conn. 466, 471; *Hurd v. Everett*, 1 Paige (N. Y.) 124; *Heath v. Whidden*, 29 Me. 108; *Brockaway v. Thomas*, 32 Ark. 311; 1 Enc. Pl. & Pr. 621.

Much reliance is placed upon *Car Coupler Co. v. League*, 25 Colo. 129, 54 Pac. 642, in which there is some language which may possibly seem to be in conflict with what we have said respecting the correction of errors and omissions in jurisdictional allegations; but as the language there employed was in the nature of a concession not required by the facts of that case, as no reference was made therein to the earlier decision in *Southwestern Land Company v. Hickory Jackson Ditch Company*, supra, and as general remarks or concessions not necessary at the time are not regarded as overturning or qualifying earlier rulings necessary to the decision of the cases then in hand, we think the language relied upon cannot reasonably be accepted as intended to overturn or qualify the earlier decision.

Whether there was an abuse of discretion in the allowance of the amendment, without some prior notice to the respondents of the application therefor, is not now open to consideration, because at most

that would only be an error in the exercise of a lawful jurisdiction, and would not render the judgment void so as to open it to collateral attack. *Tilton v. Cofield*, 93 U. S. 163, 167, 23 L. Ed. 858.

As the Circuit Court rightly held that the judgment in the condemnation proceeding was not void, its judgment is affirmed.

DECKER v. PACIFIC COAST S. S. CO.

(Circuit Court of Appeals, Ninth Circuit. October 19, 1908.)

No. 1,564.

1. NAVIGABLE WATERS (§ 43*)—RIGHTS OF OWNER OF SHORE LANDS IN ALASKA—WHARVES.

An owner of lands in Alaska which border on tidal waters has no title to the soil below high-water mark, and cannot enjoin the maintenance of a wharf or other structure in aid of navigation thereon, unless it prevents his own free access to the navigable waters.

[Ed. Note.—For other cases, see *Navigable Waters*, Dec. Dig. § 43.*]

2. NAVIGABLE WATERS (§ 43*)—EQUITABLE OWNER OF SHORE LANDS—CONVEYANCE OF LITTORAL RIGHTS.

An equitable owner or claimant of government lands in Alaska on the seashore may convey his littoral rights to an individual or corporation, to enable such grantee to erect and maintain a wharf for the benefit of commerce and navigation.

[Ed. Note.—For other cases, see *Navigable Waters*, Cent. Dig. §§ 256, 257; Dec. Dig. § 43.*]

Appeal from the District Court of the United States for Division No. 1 of the District of Alaska.

This is an action brought by appellant against the Pacific Coast Steamship Company and John Johnston in the United States District Court for the District of Alaska, First Division, to abate a private nuisance, to wit, the erection and maintenance of buildings and a wharf between certain property and deep water in the town of Juneau, Alaska, described as block L, which premises, it is alleged in the complaint, abut on the waters of Gastineaux Channel at mean high tide, and against which premises the tide regularly ebbs and flows twice in 24 hours. In this property appellant is equally interested with said Johnston, who refused to join as plaintiff in the action and who was accordingly made defendant. It is alleged in the complaint that by the erection and maintenance of the buildings and wharf by the defendant corporation the plaintiff has been and will continue to be deprived of her right and prevented from wharfing out or maintaining a wharf in front of her premises, and prevented from access to deep water from her abutting premises. The prayer is that the buildings and wharf be declared to be a private nuisance and that the same be abated, and for damages in the sum of \$1,000. Default was entered against defendant Johnston, who failed to appear.

The answer of appellee admitted the allegations of the complaint as to appellee's corporate existence, appellant's part ownership of the premises described in the complaint, and that the premises "abut on the waters of Gastineaux Channel at mean high tide, and against which premises the tide regularly ebbs and flows twice in 24 hours," but denies all the other material allegations of the bill. For an affirmative defense the answer alleges that on February 20, 1897, appellant, as one of the owners of blocks K and L in the town of Juneau, Alaska, joined in a deed of conveyance to the People's Wharf Company of "all littoral and appurtenant rights by them owned, or any littoral or appurtenant rights that might thereafter exist, in and to the shore of Gastineaux Channel between ordinary line of high tide and deep water

*For other cases see same topic & § NUMBER in Dec. & Am. Digs. 1907 to date, & Rep'r Indexes

in the town of Juneau, Alaska, except the warehouse and building occupied by the said E. O. Decker and J. M. Decker"; that on April 1, 1898, the premises and rights under said deed were acquired through mesne conveyances by the Pacific Coast Company, a corporation, in good faith, for a valuable consideration, and without notice of any claim whatsoever of the appellant or her grantors; that valuable improvements, considerably in excess of \$30,000, had been erected on the premises by the Pacific Coast Company and its predecessors in interest, and that the Pacific Coast Company had maintained open, notorious and exclusive possession of the premises ever since such purchase; that appellant and her predecessors in interest ought to be estopped from asserting any right, title, or interest in or to said premises; that appellee is the lessee of the premises, and therefore not the real party in interest; that appellee has not erected said wharf, nor the Union Iron Works, nor any structure upon the said premises, and does not claim the ownership of the same, but merely claims the possession of the same under its lease from the Pacific Coast Company; that the Pacific Coast Steamship Company is not the real party in interest, and there is, therefore, a defect of parties defendant.

Appellant's reply denied the execution or recording of any deed conveying any littoral or appurtenant rights to the shore of Gastineaux Channel by herself and the other parties named in the answer as grantors, denied the corporate existence of the People's Wharf Company and all other material allegations of the answer, and alleged that "on February 20, 1897, the said real property mentioned in the answer was, * * * and up to the 5th day of October, 1898, remained exclusively the property of the United States of America, and was not owned by private persons or subject to private ownership"; that complainant knew nothing of business and had depended on hired counsel, none of whom had, until the past year, informed her of her rights; and that previous to that she had at almost all times since her majority been a housewife.

The case was tried before the court, and upon the evidence taken the court found as facts that the entry of the town site of Juneau was made by the receiver and register of the land office at Sitka, Alaska, on the 13th day of October, 1893; that thereafter, to wit, on the 4th day of September, 1897, a United States patent was duly issued by the President of the United States to Thomas R. Lyons, as trustee, for the use and benefit of the occupants of said town site of Juneau; that blocks K and L were a portion of said Juneau town site, and said blocks or parcels of land abut on the mean high tide land of Gastineaux Channel, an arm of the Pacific Ocean; that on and prior to the 20th day of February, 1897, one E. O. Decker and J. M. Decker were the owners of, in possession of, and entitled to the possession, as against all parties save the United States, in which the legal title then stood, of blocks K and L of the town of Juneau, in the district of Alaska, and while said E. O. Decker and said J. M. Decker were the owners of said blocks, and on the 20th day of February, 1897, said E. O. Decker and J. M. Decker and Lizzie Decker, the then wife of said E. O. Decker, who is the same person as the appellant herein, Elizabeth Decker, did by due and proper deed of conveyance quitclaim and convey to the People's Wharf Company, a corporation, all of their littoral and riparian rights immediately abutting on said blocks K and L, except a small warehouse situate on said tide land, and which is not in controversy in this action, and further by said conveyance quitclaimed by proper conveyance to the said People's Wharf Company all the littoral rights which they or either of them might acquire to the said tide lands of Gastineaux Channel abutting on said blocks K and L, and thereafter by mesne conveyances the Pacific Coast Company, a corporation, acquired all the right, title, and interest of the said People's Wharf Company in and to all the littoral and riparian rights immediately in front of and abutting upon said blocks K and L, and that said Pacific Coast Company was then and had been the owner of and in possession, by its lessee, the Pacific Coast Steamship Company, and entitled to the possession, as against all persons save its lessee and the United States, of all said premises at the time of the commencement of this action; that since the 20th day of February, 1897, and before appellant obtained title by decree of distribution to the said lots, or any portion thereof, the said People's Wharf Company and their successors in interest had erected upon said tide lands

valuable improvements in the shape of shops, stores, wharves, and docks, at a great expense, aggregating the approximate sum of \$18,000; that all of such properties, except the warehouse, and all of the littoral and riparian rights and tide lands in controversy, had been in the actual, notorious, and exclusive possession of the Pacific Coast Company and its grantors since the 20th day of February, 1897; that the appellee, the Pacific Coast Steamship Company, was the lessee of the Pacific Coast Company, and was not the real party in interest, and had not erected any wharves or any structures upon said premises, and did not claim the ownership of the same, but merely claimed the possession of the same under its lease from the Pacific Coast Company. Upon these findings the court dismissed the bill.

E. M. Barnes, for appellant.

Shackleford & Lyons (Geo. W. Towle, of counsel), for appellee.

Before GILBERT, ROSS, and MORROW, Circuit Judges.

MORROW, Circuit Judge (after stating the facts as above). In the recent case of *Columbia Canning Company v. Hampton*, 161 Fed. 64, this court had occasion to consider the claim of right asserted by the locator of land in Alaska which bordered on navigable or tidal waters to occupy the shore between high tide and low tide abutting upon his upland location as a basis for the purpose of carrying on the fishing business in connection with a fish trap extending out into the navigable waters of Lynn Canal. The court held that the littoral right attached to plaintiff's homestead location entitled him to free access to the navigable waters of Lynn Canal, but not to build upon the shore or erect any structure reaching out into deep water, so as to obstruct navigation. In support of this rule the court cited *Gould on Waters* (3d Ed.) par. 149, *Hardin v. Jordan*, 140 U. S. 371, 11 Sup. Ct. 808, 35 L. Ed. 428, and *Shively v. Bowlby*, 152 U. S. 1, 58, 14 Sup. Ct. 548, 38 L. Ed. 331, and said:

"It follows, from these authorities, that while the owner or locator of lands in Alaska which border upon navigable or tidal waters has, under the general law, the right of access to such waters for the purpose of navigation, he can acquire no right or title to the soil below high-water mark, and he can have, therefore, no right of possession upon which he can base an action against an intruder whom he charges with interfering with and obstructing him in the erection and use of a structure upon the shore below such high-water mark."

The court said further:

"He may have, however, a right of action against an intruder who places obstacles on the shore that prevent him from having access to the navigable waters."

This is the general rule, and is designed to keep navigable waters free and open to the public for commerce and navigation, and at the same time permit the littoral owner and those engaged in commerce and navigation to have access to navigable waters; but it cannot be ascertained from the allegations of the complaint in this case, nor does it appear in evidence, in what manner the maintenance of the buildings and wharf by the appellee in front of appellant's premises prevents her from having access to the navigable waters of Gastineaux Channel. The presumption is that such access would be facilitated, rather than obstructed, by the maintenance of a wharf and other suit-

able structures for the accommodation of the public in the discharge and shipment of passengers and merchandise arriving and departing by water at the port of Juneau.

But, however that may be, there is a more serious objection to appellant's cause of action. In the deed of February 20, 1897, introduced in evidence by the appellee, E. O. Decker and J. M. Decker and the appellant, the then wife of E. O. Decker, conveyed, not only the then rights of the grantors, but also all the right, title, and interest and estate, legal and equitable, to the shore of Gastineaux Channel, which they then or might thereafter possess, by virtue of any law of the United States or otherwise, by reason of their ownership of blocks K and L, in the town of Juneau, and further granted the right to wharf out from the said premises southwesterly to deep water and maintain wharves and warehouses thereon for the benefit of trade and commerce, and to own, possess, and occupy the same forever by itself and its successors and assigns.

It is contended by the appellant that the evidence relating to this deed was incompetent, and should have been excluded, on the ground that Congress alone had the power to make grants below high-water mark in the territory of Alaska, and for the further reason that the rights of the littoral owner cannot be detached from the soil out of which they arise or to which they are incident, and therefore cannot be transferred without an actual conveyance of the soil itself. In the case of *McCloskey v. Pacific Coast Company* (C. C. A.) 160 Fed. 794, the owner of a lot in the town of Juneau had brought a suit in equity to enjoin the defendant from erecting a structure on tide lands in front of property belonging to the plaintiff fronting on Gastineaux Channel, alleging that as a littoral owner of lands abutting on the shore plaintiff was entitled to free access to and from the navigable waters fronting thereon. The defendant in his answer denied that plaintiff was a littoral owner of the seashore and alleged facts to show that by the dedication and grant of a sidewalk and street in front of its land the plaintiff had parted with all of its littoral rights. The court below held that plaintiff possessed the littoral right of access to the water in front of its land and on that ground awarded an injunction. This court, upon the evidence of the dedication and a grant by deed of the strip of land for a sidewalk and street along the water front of plaintiff's premises, held that the plaintiff had by dedication and deed parted with all its littoral rights, although the order granting a preliminary injunction was affirmed on a right of possession established under Act May 17, 1884, c. 53, 23 Stat. 24, 26.

If the littoral owner can dedicate or convey to the public his right of access to the navigable waters in front of his premises, he can convey that right to an individual or to a corporation for the purpose of enabling such individual or corporation to erect and maintain a wharf for the benefit of commerce and navigation. The law of that case is applicable here, and we are of opinion that, whatever appellant's rights may have been as the owner of land abutting on navigable waters, she parted with such rights in the deed of February 20, 1897, that the appellee's lessor has succeeded to such rights, and the appel-

lant cannot, upon the facts in the case, maintain this action to abate the wharf and buildings occupied by the appellee as a nuisance.

The judgment of the District Court is affirmed.

CALIFORNIAN CANNERIES CO., Limited, v. PACIFIC SHEET METAL WORKS.

(Circuit Court of Appeals, Ninth Circuit. October 12, 1908.)

No. 1,452.

SET-OFF AND COUNTERCLAIM (§ 36*)—SUBJECT-MATTER OF COUNTERCLAIM—CLAIM ARISING OUT OF SAME TRANSACTION.

Under Code Civ. Proc. Cal. § 438, which authorizes a defendant to plead as a counterclaim "a cause of action arising out of the transaction set forth in the complaint as the foundation of the plaintiff's claim, or connected with the subject of the action" or in an action arising upon contract, any other cause of action arising also upon contract "and existing at the commencement of the action," a promissory note arising out of the same transaction set forth in the complaint may be pleaded as a counterclaim, although not due when the action was commenced, if due when pleaded.

[Ed. Note.—For other cases, see Set-Off and Counterclaim, Dec. Dig. § 36.*]

In Error to the Circuit Court of the United States for the Northern District of California.

For opinion below, see 144 Fed. 886.

Joseph C. Meyerstein, Jellett & Meyerstein, and Platt & Bayne, for plaintiff in error.

Warren Olney and Olney & Mann, for defendant in error.

Before GILBERT and ROSS, Circuit Judges, and DE HAVEN, District Judge.

DE HAVEN, District Judge. This is an action to recover damages for an alleged breach of contract for the sale and delivery of cans for the use of plaintiff in its cannery. The answer denies the alleged breach of contract, and in addition thereto sets up a counterclaim in the sum of \$3,064.15, alleged to be due defendant upon a promissory note, given by the plaintiff to the defendant, on account of cans delivered by the defendant under the contract set out in the complaint. This note was not due when the action was commenced, but was due at the time the answer was filed. The action was tried by the court without a jury. The court found that defendant had not complied with the contract, set out in the complaint, and that plaintiff had sustained damages thereby; and also found:

"That plaintiff executed to defendant the note, set out in the counterclaim, in the sum of \$3,034.16, payable one year after date, and that, of the amount of this note, \$1,640.72 was on account of an indebtedness, in behalf of the defendant and against the plaintiff, arising out of the transaction set forth in the complaint of plaintiff as the foundation of plaintiff's claim, and connected with the subject of this action."

*For other cases see same topic & § NUMBER in Dec. & Am. Digs. 1907 to date, & Rep'r Indexes

Judgment was thereupon entered in favor of the plaintiff for the damages sustained by it, less the sum of \$1,670.72, allowed the defendant as a set-off. The case is brought here by the plaintiff on writ of error. The action of the court in allowing the defendant's set-off—in the sum stated—is the only error assigned.

1. It is argued in support of this assignment of error that no part of the amount due upon the promissory note, set out in defendant's answer, is a proper subject of counterclaim, because the note was not due at the time of the commencement of this action.

This being an action at law, the question of defendant's right to assert the counterclaim, allowed by the Circuit Court, is governed by the law of California relating to the subject of counterclaims. *Partridge v. Insurance Company*, 15 Wall. 573, 21 L. Ed. 229; *Charnley v. Sibley*, 73 Fed. 981, 20 C. C. A. 157; section 914, Rev. St. (U. S. Comp. St. 1901, p. 684).

Section 437 of the Code of Civil Procedure of California provides that the answer of the defendant shall contain a statement of any new matter constituting a defense or counterclaim, and section 438 of the same Code provides:

"The counter-claim mentioned in the last section must be one existing in favor of a defendant and against a plaintiff between whom a several judgment might be had in the action, and arising out of one of the following causes of action:

"(1) A cause of action arising out of the transaction set forth in the complaint as the foundation of the plaintiff's claim, or connected with the subject of the action;

"(2) In an action arising upon contract, any other cause of action arising also upon contract, and existing at the commencement of the action."

The action of the court in allowing so much of defendant's counterclaim as arose out of the contract, set out in the complaint, as the foundation of plaintiff's claim, was clearly justified by subdivision 1 of the section just quoted. The fact that the promissory note in which the counterclaim was included did not become due until a few days after the commencement of the action does not affect the question. The note was due when the counterclaim was filed, and at the date of the trial, and this is all that was required to entitle the defendant to avail itself of the set-off allowed by the court. Certainly there can be no reasonable objection to adjusting in one action all the claims of the respective parties, which arise out of the contract sued on, and the law contemplates that this may be done. If authority were needed to support this conclusion, it will be found in *Smith v. French*, 141 N. C. 1, 53 S. E. 435, in which case the Supreme Court of North Carolina, in passing upon a section in all respects like that above quoted from the California Code of Civil Procedure, said:

"It will be noted that the requirement restricting a counterclaim to one that exists at the time the action was commenced is only stated in reference to the second class of counterclaims described in the statute—those wherein an action on a contract, the breach of an entirely different and distinct contract, is set up by defendant."

And the court then added that, when the counterclaim is one that arises out of the transaction set forth in the complaint, "it would seem

to be sufficient if it matures at any time before the answer is filed, and might be available if it matures at any time before the trial."

Judgment affirmed.

PACIFIC SHEET METAL WORKS v. CALIFORNIAN CANNERIES CO.,
Limited.

(Circuit Court of Appeals, Ninth Circuit. October 12, 1908.)

No. 1,531.

1. APPEAL AND ERROR (§ 1010*)—REVIEW—FINDINGS OF FACT.

The finding of a Circuit Court on a question of fact in an action at law tried by stipulation without a jury is conclusive on a reviewing court if there is any evidence in its support.

[Ed. Note.—For other cases, see Appeal and Error, Cent. Dig. § 3979; Dec. Dig. § 1010.*]

2. COURTS (§ 356*)—PRACTICE IN FEDERAL COURTS—APPEAL—RECORD—OPINION OF LOWER COURT.

Under the federal practice the opinion of a trial court cannot be referred to by an appellate court for the purpose of ascertaining the facts upon which the judgment was based, nor to control the formal findings made, although a reference thereto is incorporated in the bill of exceptions.

[Ed. Note.—For other cases, see Courts, Cent. Dig. § 937; Dec. Dig. § 356.*]

3. CONTRACTS (§ 303*)—ACTION FOR BREACH—DEFENSES.

Under a contract which required defendant to furnish plaintiffs with all the tin cans required in its cannery during a season, not exceeding a stated number in any one day, with a proviso that it should be released from any obligation if it should be unable to perform by reason, *inter alia*, "of damage by the elements or of any unavoidable casualty," it was no defense to an action for breach of the contract for failure to furnish the number of cans required that defendant contemplated the use of a cargo of tin which at the time the contract was made had been shipped from Liverpool for San Francisco by way of Cape Horn, and that by reason of adverse weather the vessel was longer than usual in making the voyage, there being no provision in the contract with respect to such shipment.

[Ed. Note.—For other cases, see Contracts, Cent. Dig. § 1409; Dec. Dig. § 303.*]

4. DAMAGES (§ 23*)—BREACH OF CONTRACT—LOSS OF PROFITS.

Where it was within the contemplation of the parties when such contract was made that plaintiff was engaged in canning green fruit and vegetables during the season, that it would make contracts for the purchase of such supplies and for the sale of its canned products in reliance on its contract with defendant for cans, on a failure to furnish the number required plaintiff was entitled to show as an element of the damages recoverable the profit it would have realized from its sales but for the breach of contract.

[Ed. Note.—For other cases, see Damages, Cent. Dig. § 58; Dec. Dig. § 23.*]

In Error to the Circuit Court of the United States for the Northern District of California.

For opinion below, see 144 Fed. 886.

Olney & Mannon, for plaintiff in error.

H. G. Platt, Richard Bayne, and Joseph C. Meyerstein, for defendant in error.

Before GILBERT and ROSS, Circuit Judges, and DE HAVEN, District Judge.

DE HAVEN, District Judge. This action was brought by the Californian Canneries Company, Limited, a corporation, to recover damages from the Pacific Sheet Metal Works, a corporation, for alleged breach of contract.

The complaint charges that plaintiff and defendant entered into a contract by which the plaintiff agreed to purchase, and defendant agreed to sell and deliver to plaintiff, between July 12 and December 31, 1899, as and when ordered, all the tin cans which should be used in plaintiff's cannery at San Francisco during the packing season of 1899, not exceeding 100,000 cans in any one day; that at the time of the execution of the contract defendant knew that plaintiff was engaged in the business of canning green fruit and vegetables, and, in reliance upon the performance of said contract by defendant, would purchase large quantities of green fruits and vegetables, and would enter into contracts for the sale and delivery thereof when canned, and that unless said cans were promptly delivered, as ordered, the plaintiff would be unable to pack all of the fruit and vegetables purchased for canning, or comply with its contracts for the sale and delivery of such canned products, and would lose the profit which it would otherwise make from the sale of the same. The complaint further alleges that defendant did not deliver the number or variety of cans ordered by plaintiff under said agreement; that plaintiff thereby sustained damage in the sum of \$28,578, on account of fruit which it was compelled to throw away, loss of profit which it would have made if such fruit had been canned, and for wages paid its employes during times when they were idle, waiting for defendant to make delivery of the cans contracted for.

The answer of defendant denies all of the material allegations of the complaint, and then alleges that the only contract made between the plaintiff and defendant is the one fully set out in the answer, the material parts of which are as follows:

"This agreement executed in duplicate by and between the Pacific Sheet Metal Works, hereinafter called seller, and Californian Canneries Company, Ltd., of Newcastle on Tyne, England, hereinafter called buyer, witnesseth:

"1. The seller agrees to sell and deliver to the buyer, and the buyer agrees to purchase and receive of and from the seller, all the tin cans which shall be used in its or their cannery at San Francisco, during the packing season of 1899, not exceeding, however, 100,000 cans in any one day."

"4. Place of delivery f. o. b. San Francisco, at its cannery.

"8. If the seller shall be unable to perform any of its obligations under this contract, by reason of strike or of damage by the elements, or of any unavoidable casualty, such obligations shall at once terminate and cease."

The answer also alleges, as matters of defense:

"(1) That a strike was inaugurated in defendant's factory on August 24, 1899, by its workmen, whereby it was released from performing its contract.

"(2) That, at the date of the contract between plaintiff and defendant, defendant had on board the ship Ancois, then on her way from Liverpool to San Francisco, enough tin plate for the manufacture of 5,000,000 tin cans. That said ship, with said tin plate on board, sailed from Liverpool, England, on January 23, 1899. That the usual time required for a voyage for such a ship from Liverpool to the port of San Francisco is from 115 days to 140 days, but she did not arrive in San Francisco until July 30, 1899, having been 182 days on her voyage; that the Ancois was in all respects seaworthy and fit for the voyage in which she was engaged, and that the delay in arriving at San Francisco was caused by damage done to her by the storms and high winds which she encountered in making the voyage."

The case was tried by the court without a jury, and the court found:

That the contract between plaintiff and defendant is correctly set forth in the answer; that—

"the defendant between August 8, 1899, and September 13, 1899, failed to deliver to plaintiff 143,000 cans, under and in accordance with the terms of the contract of April 12, 1899.

"That on the 24th and 25th days of August, 1899, there was a strike in defendant's factory, which released the defendant from the necessity of complying with the orders of plaintiff for those two days, and that plaintiff was not entitled to demand cans from defendant on Sundays and other legal holidays, during the period of the said contract, but that the said defendant failed to deliver to plaintiff 143,000 cans under the terms of said contract, exclusive of those cans from which it was released by reason of the said strike, and cans ordered on Sundays and holidays."

The court further found that the defendants purchased in England, and shipped on board the Ancois, enough tin plate for the manufacture of 5,000,000 tin cans; that said ship sailed from Liverpool, England, for San Francisco on January 28, 1899, that the usual time required for such a voyage, by a vessel like the Ancois, is from 115 to 140 days; that she did not arrive at the port of San Francisco until July 30, 1899, 182 days after leaving Liverpool; that this delay was caused by heavy storms and calms encountered by the ship.

Upon these and other findings as to the loss of fruit which plaintiff was compelled to throw away because of nondelivery of cans, and loss of profit upon fruit which would have been canned had defendant furnished the cans which plaintiff was entitled to receive under the contract, and wages paid by plaintiff to its employes during times when they were idle because cans were not delivered when ordered, the court found that plaintiff had sustained damage, by reason of defendant's breach of contract, in the sum of \$7,264.75, with interest thereon at 7 per cent. per annum from December 22, 1900, and after deducting therefrom \$1,640.72, with interest at the rate of 6 per cent. per annum from January 1, 1900, which it allowed defendant as a set-off, the court further found that plaintiff was entitled to recover from defendant \$8,084.57. Judgment was thereupon entered in favor of the plaintiff for that sum with costs. The case is brought here by the defendant on a writ of error.

1. The plaintiff in error insists that the Circuit Court erred in finding that there was a failure on its part to deliver 143,000 or any number of cans, required or needed by the defendant in error at its cannery. Whether there was such failure or not is a pure question of fact, and this being an action at law, and before us on writ of error,

the finding of the Circuit Court as to the fact, if there was any evidence upon which to base the finding, is conclusive here. *King v. Smith*, 110 Fed. 95, 49 C. C. A. 46, 54 L. R. A. 708; *Eureka County Bank v. Clarke*, 130 Fed. 326, 64 C. C. A. 571; *Dooley v. Pease*, 180 U. S. 126, 21 Sup. Ct. 329, 45 L. Ed. 457; *Stanley v. Supervisors*, 121 U. S. 547, 7 Sup. Ct. 1234, 30 L. Ed. 1000; *Runkle v. Burnham*, 153 U. S. 216, 14 Sup. Ct. 837, 38 L. Ed. 694; *Hathaway v. Bank*, 134 U. S. 494, 10 Sup. Ct. 608, 33 L. Ed. 1004.

We cannot say from the record before us that there was no evidence before the Circuit Court in support of the finding to which exception is taken. The contract between the parties bound the plaintiff in error to sell and deliver, and the defendant in error to purchase from the former, all of the tin cans which the latter would need for use in its cannery at San Francisco during the year 1899, not exceeding 100,000 cans in any one day. The number of cans which would thus be needed not having been definitely fixed by the contract, it was the duty of the defendant in error to notify the plaintiff in error of the number which it would need, and, if after such notice the plaintiff in error failed to deliver the cans so called for, the failure to deliver constituted a breach of the contract on its part, provided the number demanded was not more than 100,000 cans in any one day, and was not in excess of the number actually needed by the defendant in error at its cannery.

There was much evidence tending to show that the defendant in error made demands upon the plaintiff in error from time to time, between the dates named in the finding of the court, for delivery of cans, under the contract; that the number of cans ordered was less than the maximum number stated in the contract; that all of the cans called for were needed in its business; that the cans so ordered were not all delivered, and that in consequence thereof the defendant in error was compelled to throw away a great deal of fruit which it had purchased and had on hand for the purpose of canning. It was for the court below to determine from this, and from the counter evidence offered by the plaintiff in error, whether there had been any breach of contract on the part of the plaintiff in error, and, under the rule established by the cases above cited, its finding as to the fact cannot be disturbed by us. As said in *Behn v. Campbell*, 205 U. S. 407, 27 Sup. Ct. 504 (51 L. Ed. 857):

"An appeal brings up questions of fact, but upon a writ of error only questions of law apparent on the record can be considered, and there can be no inquiry whether there was error in dealing with questions of fact."

2. It is also assigned as error that the undisputed facts show that in finding that the plaintiff in error failed to deliver 143,000 cans, ordered by the defendant in error, the court erroneously included in such finding 35,250 cans not delivered on August 24th, on which day there was a strike which excused the plaintiff in error from making a delivery on that day. It is argued that this error is conclusively shown by the opinion which was filed by the judge of the Circuit Court, and that this opinion is made a part of the record to which this court has a right to look for the purpose of ascertaining the facts by the following recital found in the bill of exceptions:

"The particulars making up what the court claims is a total shortage of 143,000 cans are stated in the opinion of the court, to which reference is here made."

It has been distinctly held that the opinion of the court, assigning reasons for its conclusions, cannot be treated as a special finding. *British Queen Mining Co. v. Baker Silver Mining Co.*, 139 U. S. 222, 11 Sup. Ct. 523, 35 L. Ed. 147. Nor can the opinion of the trial court be considered for the purpose of helping the findings. *Saltonstall v. Birtwell*, 150 U. S. 417, 14 Sup. Ct. 169, 37 L. Ed. 1128. Nor for the purpose of modifying or controlling the findings. *Stone v. U. S.*, 164 U. S. 380, 17 Sup. Ct. 71, 41 L. Ed. 477; *Townsend v. Beatrice Cemetery Ass'n*, 138 Fed. 381, 70 C. C. A. 521; *Kentucky Life & Accident Ins. Co. v. Hamilton*, 63 Fed. 93, 11 C. C. A. 42; *Hinkley v. City of Arkansas City*, 69 Fed. 768, 16 C. C. A. 395.

In *Loeb v. Columbia Township Trustees*, 179 U. S. 472, 21 Sup. Ct. 174, 45 L. Ed. 280, it was held that the opinion of the Circuit Court might be examined by the Supreme Court in order to ascertain "whether either party claimed that the state statute, upon which the judgment necessarily depended, in whole or in part, was in contravention of the Constitution of the United States"; and the court added:

"By this, however, we must not be understood as saying that the opinion below may be examined in order to ascertain that which under proper practice should be made to appear in the bill of exceptions, or by an agreed statement of facts, or by the pleadings."

And it was further said in that case, referring to certain language found in *England v. Gebhardt*, 112 U. S. 502, 5 Sup. Ct. 287, 28 L. Ed. 811:

"What was said may undoubtedly be taken as an adjudication that the opinion of the court cannot under our rule be referred to for the purpose of ascertaining the evidence or the facts found below, upon which the judgment was based."

Under the rule declared in the foregoing cases, we are precluded from referring to the opinion of the Circuit Court for the purpose of ascertaining the facts upon which its judgment was based, unless the recital above quoted from the bill of exceptions makes the rule inapplicable, and we are clearly of opinion that it does not have this effect. The recital does not change the opinion of the Circuit Judge into a special finding of facts, nor make the opinion anything other than what it was when originally filed—a simple memorandum or statement of the reasons for the general conclusion reached by the judge, but never intended to take the place of the more full and deliberate findings of facts and conclusions of law subsequently made and filed, and upon which the judgment of the court rests.

3. The finding that plaintiff in error shipped a large quantity of tin upon the ship *Ancois*, and that such ship was delayed in reaching San Francisco on account of the storms and winds encountered by her on the voyage from Liverpool, does not constitute a defense to the action. Such finding is not sufficient to show that the plaintiff in error was prevented from the performance of its contract by reason of "damage by the elements, or any unavoidable casualty." If the contract had contained an express or implied stipulation that the cans

plaintiff in error agreed to deliver were to be manufactured from the tin then laden on the Ancois and to be by her brought from Liverpool to San Francisco, around Cape Horn, the question would be different from the one now before us. *Anderson v. May*, 50 Minn. 280, 52 N. W. 530, 17 L. R. A. 555, 36 Am. St. Rep. 642; *Stewart v. Stone*, 127 N. Y. 502, 28 N. E. 595, 14 L. R. A. 215. But there was no such express stipulation, and there is nothing in the nature of the contract itself, when considered in connection with the surrounding circumstances and situation of the parties, to authorize the court to construe it as containing such an implied condition or stipulation. The contract was an absolute one upon the part of the plaintiff in error to deliver the cans referred to in the contract, unless prevented from so doing by an unavoidable casualty or by reason of damage from the elements. If the plaintiff in error did not have on hand a sufficient quantity of tin for the manufacture of the cans contracted for, it was free to adopt any course to procure the tin, needed to carry out the contract, which its judgment might suggest. It was not restricted to shipping the same around Cape Horn, on the Ancois. It had the right under its contract to import the tin into New York and then bring the same by rail to San Francisco, and it cannot be excused from performance by reason of the facts that it chose to rely upon the ability of the Ancois to make the voyage around Cape Horn within such time as would permit it to fulfill its contract, rather than to have the tin brought from New York by rail, and that the vessel was delayed by storms and winds beyond the time usually consumed on such a voyage.

4. The complaint alleged, and there was evidence tending to show, that it was within the contemplation of the parties when the contract was made that defendant in error would sell the fruit which it might can, and had entered into contracts to sell the same. In view of the allegations of the complaint, and this evidence, the court did not err in permitting the defendant in error to show the profits which it would have realized upon fruit which it would have canned if the plaintiff in error had complied with its contract. *Messmore v. New York Shot & Lead Co.*, 40 N. Y. 422; *Griffin v. Colver*, 16 N. Y. 493, 69 Am. Dec. 718.

Judgment affirmed.

T. C. HENRY & SONS & CO. v. COLORADO FARM & LIVE STOCK CO.†
(Circuit Court of Appeals, Eighth Circuit. November 7, 1908.)

No. 2,575.

1. BROKERS (§ 11*)—EMPLOYMENT BY INTENDING SELLER—STIPULATION AS TO COMMISSION—REFUSAL TO SELL TO ACCEPTABLE PURCHASER—EMPLOYER'S LIABILITY TO BROKER.

A., being desirous of selling certain of his property, employed a broker to procure a purchaser able, ready, and willing to buy upon acceptable terms, one of which was that the purchaser should pay the broker's commission as part of the purchase price. The broker procured such a purchaser, with whom A. entered into a contract to sell, one of the terms of which was that the broker's commission should be paid by the purchaser in certain bonds to be issued by a corporation to be organized by the purchaser to take over the property from him. Without fault on the part of the purchaser, A. thereafter refused to complete the sale, and the broker thereby lost his right to exact payment of his commission from the purchaser. *Held*: (1) A. impliedly obligated himself to the broker to complete the sale, if an acceptable purchaser was procured by him, so that he might realize his commission. (2) The refusal to complete the sale was a breach of that obligation, and gave to the broker a right of action against A. for the damages thereby sustained. (3) It was not essential to that right of action that the proposed corporation should be brought into being, or that it should adopt or ratify the purchaser's engagement respecting the issuance of the bonds.

[Ed. Note.—For other cases, see Brokers, Cent. Dig. § 58; Dec. Dig. § 11.*]

2. COURTS (§ 329*)—CIRCUIT COURTS—JURISDICTION—AMOUNT IN CONTROVERSY—PLEADING.

In an action between citizens of different states in a Circuit Court of the United States, where the complaint contains the requisite allegation respecting the amount in controversy, jurisdiction is not defeated because other matters stated in the complaint have a tendency to show that that allegation is not well founded, unless they are such as to create a legal certainty of that conclusion.

[Ed. Note.—For other cases, see Courts, Cent. Dig. § 897; Dec. Dig. § 329.*]

Jurisdiction of Circuit Courts as determined by the amount in controversy, see notes to *Auer v. Lombard*, 19 C. C. A. 75; *Tennent-Stribling Shoe Co. v. Roper*, 36 C. C. A. 459.]

(Syllabus by the Court.)

In Error to the Circuit Court of the United States for the District of Colorado.

John F. Shafroth (John R. Smith, on the brief), for plaintiff in error.

James H. Pershing, for defendant in error.

Before SANBORN and VAN DEVANTER, Circuit Judges, and PHILIPS, District Judge.

VAN DEVANTER, Circuit Judge. This was an action to recover damages sustained by the plaintiff through the breach by the defendant of a contract whereby the former was induced to procure a purchaser acceptable to the latter for certain lands and other property of

*For other cases see same topic & § NUMBER in Dec. & Am. Digs. 1907 to date, & Rep'r Indexes

†Rehearing denied January 2, 1909.

the latter. In the Circuit Court the case was disposed of adversely to the plaintiff upon a general demurrer to its complaint, but the record does not disclose the theory upon which the ruling proceeded.

In addition to the usual statements respecting diverse citizenship and the sum or value of the matter in dispute, the complaint alleges that the defendant employed the plaintiff, as an agent and broker, to procure a purchaser for the property, able, ready, and willing to buy the same upon terms satisfactory to the defendant; that under that employment the plaintiff procured and brought to the defendant such a purchaser, with whom the defendant entered into a contract for the sale of the property upon terms satisfactory to both; that one of the terms of the plaintiff's employment, as also of the contract between the defendant and the purchaser, was that the plaintiff's compensation or commission for its services, as such agent and broker, should be paid by the purchaser as part of the purchase price, immediately upon the carrying out of the contract of sale by the defendant; that the compensation or commission which the plaintiff thereby became entitled to receive consisted in certain mortgage bonds to be issued by a corporation which the purchaser was to organize for the purpose of taking over the property pursuant to the contract of sale; that these bonds would have been of the actual cash value of \$16,382.50; that the purchaser was able, ready, and willing to complete the purchase according to the contract, and duly tendered performance of such of the purchaser's obligations as were to be performed in advance of the performance of the defendant's obligations, but the defendant refused, neglected, and failed to perform its obligations, and thereby prevented the sale from being completed; and that by reason of such refusal, neglect, and failure the plaintiff lost the compensation or commission which otherwise it would have been entitled to receive from the purchaser, and was thereby injured and damaged in the sum of \$16,382.50.

It is now objected that it appears from the complaint that the plaintiff did not procure a purchaser able, ready, and willing to buy upon terms satisfactory to the defendant, but only a promoter who was ready and willing to enter into an obligation to do so on behalf of a proposed corporation, which was to be the purchaser, and that it does not appear that the corporation was ever brought into being or ever adopted or ratified the act of the promoter. We pass the question which would arise if this criticism of the complaint were justified by its allegations, because the plain meaning of them, as also of the contract of sale set forth at length in the complaint, is that the purchaser procured by the plaintiff and accepted by the defendant was the firm of Magenheimer Bros., of Chicago, Ill., and not the corporation which was to be organized for the purpose of taking over the property.

The next objection is that as the plaintiff's compensation or commission was to consist of certain mortgage bonds to be issued by the proposed corporation, as it does not appear that the corporation was ever brought into being or ever adopted or ratified Magenheimer Bros.' promise respecting the issuance of the bonds, and as the defendant was without power to call the bonds into existence, it cannot be said that the plaintiff was deprived of its compensation or commission by the

defendant's refusal to complete the sale. The objection is without merit. In procuring an acceptable purchaser the plaintiff fully complied with the terms of its employment and thereby rendered a valuable service for the defendant. But for the special stipulation to the contrary, the defendant would have incurred an obligation to pay for the service so rendered. The special stipulation required that this obligation be transferred to the purchaser, as was done, as part of the purchase price; and by a necessary implication the defendant obligated himself to the plaintiff to complete the sale, if an acceptable purchaser was procured by the plaintiff, so that it might realize its compensation or commission. And, had the sale been completed by the defendant, the plaintiff's right to exact payment in some form from the purchaser would have been plain, even though the latter failed to organize the corporation or to secure an adoption or ratification by it of the engagement respecting the issuance of the bonds. *Hersey v. Tully*, 8 Colo. App. 110, 44 Pac. 854; *Roberts Mfg. Co. v. Schlick*, 62 Minn. 332, 64 N. W. 826; 10 Cyc. 269. It follows, therefore, that the refusal to complete the sale, there being no fault on the part of the purchaser, was a breach of the defendant's obligation to the plaintiff, and gave to the latter a right of action against the defendant for the damages thereby sustained. *Cavender v. Waddingham*, 2 Mo. App. 551, 554; *Atkinson v. Pack*, 114 N. C. 597, 604, 19 S. E. 628.

Finally, it is objected that the Circuit Court was without jurisdiction because the direct allegation that the sum or value of the matter in dispute exceeds the requisite jurisdictional amount is overcome and shown to be untrue when the entire complaint is considered. It is true that some of the matters alleged have some slight tendency to show that the jurisdictional allegation is not well grounded, but they fall far short of creating a legal certainty of that conclusion, and for that reason the objection must fail. *Barry v. Edmunds*, 116 U. S. 550, 6 Sup. Ct. 501, 29 L. Ed. 729; *Wiley v. Sinkler*, 179 U. S. 58, 65, 21 Sup. Ct. 17, 45 L. Ed. 84; *Smithers v. Smith*, 204 U. S. 632, 642, 27 Sup. Ct. 297, 51 L. Ed. 671.

The judgment is reversed, with a direction to overrule the demurrer.

WESTRUMITE CO. OF AMERICA v. COMMISSIONERS OF LINCOLN PARK.

(Circuit Court, N. D. Illinois, E. D. October 6, 1908.)

No. 28,926.

PATENTS (§ 328*)—INVENTION—METHOD OF SPRINKLING STREETS.

The Van Westrum patent No. 752,487, for a method of sprinkling streets, consisting of treating the loose surface of roads or streets with a mixture or "solution" of oil and water, is void on its face, there being no patentable invention or novelty in using a mixture of oil and water for that purpose, and no method known or disclosed by the patent of combining the two in solution.

[Ed. Note.—For other cases, see Patents, Dec. Dig. § 328.*]

In Equity. On final hearing on demurrer.

Walter H. Chamberlin, for complainant.

William R. Rummler and Charles A. Churan, for defendant.

KOHLSAAT, Circuit Judge. This bill is filed to restrain infringement of patent No. 752,487, granted to one Van Westrum on February 16, 1904, for an improved method of sprinkling streets. The claims are five in number, and read as follows:

"(1) The method of utilizing the granulated portions of roadbeds or streets by forming them into a top dressing or coating, by first mechanically or chemically mixing in predetermined proportions oil and water, then sprinkling or spreading the said mixture over the said loose granulated substance or dust and permeating the same, thereby unifying them and forming a concrete mass which adheres to the solid surface of the street or roadbed, thus preventing the diffusion of dust and forming the said top dressing.

"(2) The method herein described of first taking say ten parts of oil, then ninety parts of water, then mixing the same in a solution, then distributing the mixture over a surface of granulated substance by which the granules are united in a thin stratum, whereby their diffusion or scattering is prevented.

"(3) The method herein described of improving the surface of roadbeds and utilizing the loose granulated particles thereon, by sprinkling or coating them with a mixture of oily substances composed of predetermined proportions of oil and water, whereby the said substances are caked or mixed to form a coating for the purpose specified.

"(4) The method of utilizing the granulated portions of roadbeds or streets known as dust and forming it into a top dressing by permeating it with an oily substance consisting of oil and water previously and intimately mixed, whereby the said granulated particles are unified with oil and water and form a concrete mass in the manner and for the purposes specified.

"(5) The method herein described of saturating scattered dust and mixing the same with a mixture of oil and water in the proportions specified in such a manner that said dust is made to adhere to its bed, substantially as described."

The cause is now before the court on demurrer to the bill.

It will be seen that all the claims call for the mixing of oil and water. Claim 1 speaks of mixing them mechanically or chemically in predetermined proportions; claim 2 covers a solution consisting of about 10 parts of oil to 90 of water; claim 3 covers a mixture composed of predetermined proportions of oil and water; claim 4 covers oil and water previously and intimately mixed; claim 5 covers a mixture of oil and water in the proportions specified. All of the

*For other cases see same topic & § NUMBER in Dec. & Am. Digs. 1907 to date, & Rep'r Indexes

claims call for a mixing of the preparation with the loose top dressing of a road or street. The specification proceeds upon the theory that the oil and water are reduced to a solution. At line 65, p. 1, it is said:

"For the purpose of my invention in using a soluble sprinkling liquid I employ oily substances, such as petroleum, petroleum residue, or other suitable mineral or tar oils rendered soluble in water by any known process, these compounds being previously prepared so as to readily mix in solution with a larger volume of water. The proportion I prefer is about from ten to twenty parts of prepared oil to eighty or ninety parts of water, according to the depth of dust or sand to be laid," etc.

And again, at line 81, p. 1:

"This sprinkling medium has the advantage that by reason of the addition of oily substances it evaporates considerably less rapidly than pure water, while owing to the oily substances being dissolved in the water it does not leave spots on the clothing of persons which are difficult to remove."

And again, at line 13, p. 2:

"Besides, the said soluble oily substance can be dissolved in water to any desired extent," etc.

It will hardly be deemed invention to pour oil and water, ununited chemically, or not in solution, upon the top dressing or layer of a street. This condition has obtained every time a road treated with crude oil has been subjected to rain. Unless there has been some combination of the two more intimate than the mere holding of the oil in suspense in the water, it is a matter of common knowledge that neither one loses its distinctive characteristics. In other words, it is indispensable in this case that a solution should exist. It is also a matter of common knowledge that oil and water cannot be combined in solution. What the patentee meant by any well-known process of accomplishing this end is therefore indefinite and affords no information to the public. If such a process is known, it would seem proper that the bill should allege it. The recital of the patent does not amount to an allegation that any such method is known. Ordinarily, the court should not attempt to dispose of a patent on demurrer. In view, however, of the clearness of the proposition that oil and water, as a matter of common knowledge, cannot be reduced to solution, and the great expense which attends the taking of testimony in patent cases, it is deemed proper to take into consideration the matter of general knowledge upon the matter here involved, to the extent at least of placing the burden upon the complainant of alleging and proving the existence of the process referred to.

For the reason stated, the demurrer is sustained.

NOTE.—After demurrer sustained, plaintiff filed an amendment to the bill of complaint as follows:

"Second. (a) Your orator further avers and shows unto your honors that, prior to the said invention of said Van Westrum, it was known to those skilled in the art to which the said invention pertains that oil and water could be so intimately and permanently mixed as to hold the oil practically in solution in the water, so that said mixture was to all intents and purposes a solution, and that the patent to Weygang, No. 575,189, dated January 12, 1897, discloses such knowledge; a copy of said patent being attached hereto and marked 'Exhibit B.'"

A demurrer to the amended bill was sustained, and an order entered dismissing the bill for want of equity.

H. MUELLER MFG. CO. v. A. Y. McDONALY & MORRISON MFG. CO.

(Circuit Court, N. D. Iowa, E. D. October 14, 1908.)

No. 235.

1. PATENTS (§ 17*)—INVENTION—CHANGE OF FORM.

The making in one piece of that which was formerly made in two, or in two pieces what was made in one, when the function of the device is not changed is not invention, but the work of the mechanic only.

[Ed. Note.—For other cases, see Patents, Cent. Dig. § 17; Dec. Dig. § 17.*]

2. PATENTS (§ 328*)—ANTICIPATION—STOP AND WASTE COCK.

The Mueller patent No. 513,272, for a stop and waste cock, is for specific improvements only in stop and waste cocks previously in common use, and must be strictly limited and its claims interpreted in the light of its specifications, and, as so construed and limited, it is void for anticipation by numerous prior patents and structures, which disclose each one of its elements or its equivalent and produce the same result.

[Ed. Note.—For other cases, see Patents, Dec. Dig. § 328.*]

In Equity. On final hearing.

Suit for an alleged infringement of letters patent No. 513,272, issued to Henry Mueller January 23, 1894, for improvements in interchangeable right and left stop and waste cocks, and assigned to the complainant. Defense, that the patent is anticipated by prior patent and the public use of other well-known devices, and noninfringement. See, also, 132 Fed. 585.

Bond, Adams, Pickard & Jackson and M. M. Cady, for complainant. Thos. A. Banning, Banning & Banning, and Hurd, Lenehan & Kiesel, for defendant.

REED, District Judge. Interchangeable right and left stop and waste cocks were well known in the plumber's trade and in common use long before the patent in suit was applied for. In the beginning of the specifications of this patent it is stated:

"This invention relates to interchangeable right and left stop and waste cocks, and it is intended to protect the adjustable stops of said cocks, and to make the connection of the same much more secure."

After describing the invention and its operation, the specifications continue:

"The operation and the general result above described is substantially the same as in other interchangeable stop and waste cocks, but there is in my device a specific peculiarity which I will now explain. In other cocks of like character the adjustable stop bearings are held in position by a screw, and in consequence thereof such connections are somewhat insecure. Moreover, the stops are exposed to the accumulation of dirt, and, on account of the customary location of such cocks, such exposure is liable to interfere with the correct action of the stops. In my device the stops are inclosed by the stop cap itself, and the square hole of the cap fits over the square end of the plug and forms a practically rigid connection. The adjustment of the stops is to an extent of ninety degrees, so that the square bearings of the cap and plug are peculiarly fitted to the purpose. It is obvious, however, that octagon bearings, for instance, would enable the same result to be effected in nearly as

*For other cases see same topic & § NUMBER in Dec. & Am. Digs. 1907 to date, & Rep'r Indexes

desirable manner, so that, in using the word 'square' throughout the specification and claim, it is intended to be typical of prismatic as opposed to circular."

There is but a single claim, and that is for—

"an interchangeable stop and waste cock consisting of a shell having a waste hole, and a rectangular stop projection 11 formed on its side, a plug having a waste hole and a projecting end square in cross-section, a cap having a square hole in its end adapted to engage the square end of the plug, stop bearings in the cap adapted to entirely inclose and strike the stop projections of the shell, and a handle on the plug outside the cap substantially as set forth."

For convenience of reference a copy of the patent is attached hereto.

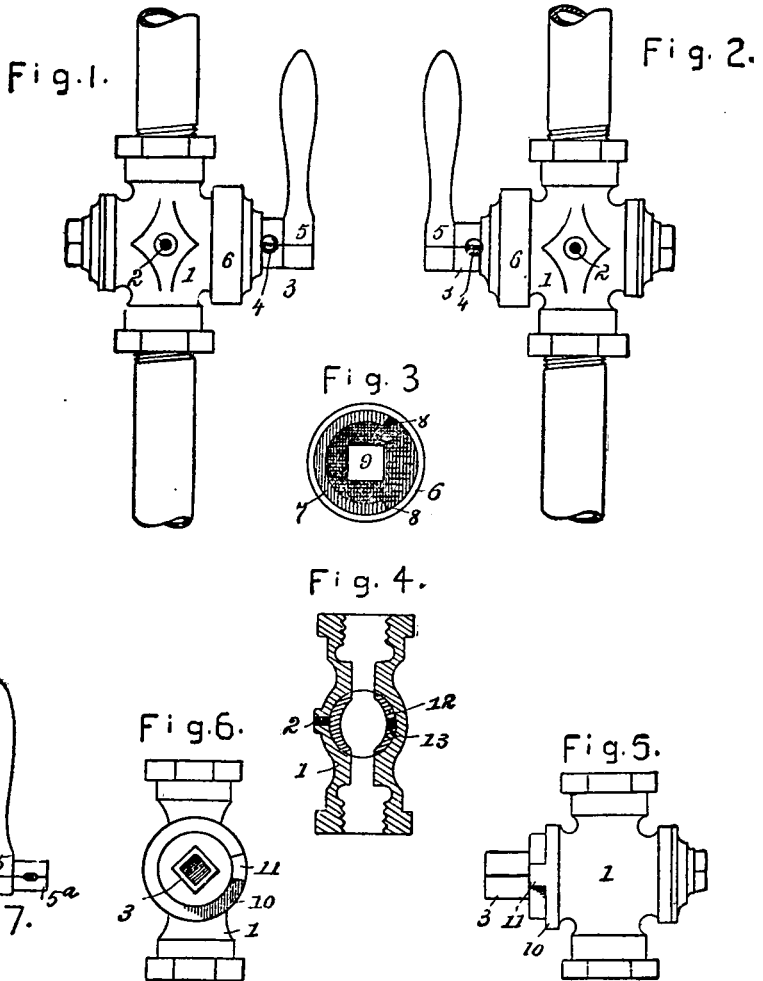

It thus appears from the patent itself that the operation of the alleged invention and the general result that it is intended to accomplish are not new, and that the patent is for specific improvements only in stop and waste cocks then in common use. It is not by any of its terms a new combination of old elements to produce a new result, but is for specific improvements only in specified elements of prior combinations in a well-developed art, is in no sense a primary invention, and must be strictly limited to its claim interpreted in the light of the specifications describing the invention. *Miller v. Manufacturing Co.*, 151 U. S. 186, 207, 208, 14 Sup. Ct. 310, 38 L. Ed. 121; *Cimiotti Co. v. Am. Fur Co.*, 198 U. S. 399, 414, 25 Sup. Ct. 697, 49 L. Ed. 1100; *Kokomo Fence Machine Co. v. Kitselman*, 189 U. S. 8, 18, 19, 23 Sup. Ct. 521, 47 L. Ed. 689; *St. Louis Street Flushing Co. v. Am. St. Flushing Co.*, 156 Fed. 574, 84 C. C. A. 340; *Union Match Co. v. Diamond Match Co.* (C. C. A.) 162 Fed. 148, 155.

What, then, is intended to be accomplished by the improvements claimed by the patent in suit? In the language of the specifications two things only, (1) to protect the adjustable stops of the stop and waste cocks then in use from the accumulation of dirt that may interfere with their correct action, and (2) to make the connection of the same much more secure. Neither the specifications nor the claim suggest any other improvement upon the earlier devices.

To sustain its defense of anticipation the defendant put in evidence a number of prior patents, and a stop and waste cock (not patented) made, placed upon the market, and sold by Cooper, Jones & Cadbury of Philadelphia, and Haines, Jones & Cadbury, their successors in business, some 10 years before the patent in suit, and maintains that the Kennedy patent of 1884, with any suitable handle, the Walsh patent of 1886, the Van Wie patent of 1891, and the Cooper, Jones & Cadbury cock, with the cap and handle in one piece of the Poppenburg or German patent of 1889, clearly anticipate the patent in suit. Mr. Bond, defendant's expert, describes in detail these various patents and the Cooper, Jones & Cadbury exhibit (hereinafter called, for convenience, the "Cadbury Exhibit"), compares them with that of complainant, and is then asked this question:

"Q. 28. Please state which one, if any, of the exhibits offered in evidence by the defendant contain the combination of all the features and elements of the Mueller claim, either in their exact form or in what you consider their plain mechanical equivalents."

He answers:

"The combination of elements or the fair equivalent of such combination, in my opinion, is found in the Ragan 1880 patent, the Zerbe 1881 patent, the Broughton 1881 patent, the Kennedy 1884 patent, and the Bailey & Grace 1892 patent. Each of these patents has the shell with the waste hole and stop or stops, a plug with a waste hole, and a stem square in cross-section or otherwise formed for the attachment of a cap, a cap on the stem of the plug, and stop bearings either on the cap or on the shell to inclose the opposing stop bearing and limit the movement of the plug, and a handle by means of which the plug can be turned. The mechanical exhibit 'Cooper, Jones & Cadbury Cock' has all of the elements called for in the claim of the Mueller patent, in my opinion."

As the Cadbury exhibit is not patented, its construction (aside from the device itself) appears only from its description by Mr. Bond, which is as follows:

"Q. 12. Please take up this exhibit cock, marked 'Defendant's Exhibit, Cooper, Jones & Cadbury Cock,' and explain its construction and operation, and compare it with the stop and waste cock shown, described, and claimed in the Mueller patent sued on, and point out the similarities which you may find between such exhibit and that of the Mueller patent.

"A. The cock 'Defendant's Exhibit, Cooper, Jones & Cadbury Cock' is a stop and waste cock. This stop and waste cock has a shell or casing with a waste opening on one side, and with two rectangular stops on the wall on opposite sides of one of the necks or extensions of the shell. The cock has a plug in which is a waste opening to coact with the waste opening in the shell. The plug has a stem, which is square in cross-section. The cock has a cap with a central square opening to receive the square stem of the plug; the cap has a depending rim or flange, which is cut away on opposite sides to form recesses terminating in bearings or stops to coact with the stop or stops on the shell to limit the turning of the plug in opening and closing the cock. The cap has integral therewith a handle, by which the turning of the plug is attained, and the cap with the handle is held in position on the square end of the stem by means of a washer and set-screw, the stem of the screw threading into the end of the plug.

"This * * * exhibit * * * has a shell with a waste opening and a rectangular projecting stop, as called for by the claim of the Mueller patent; it has a plug with a waste opening, and the stem of the plug is square in cross-section, as called for by the claim of the Mueller patent; it has a cap with a square opening to receive the square end of the stem of the plug, as called for by the claim of the Mueller patent; it has on the cap a depending flange which is cut away to form recesses with adjustable bearings to coact with the stop on the shell and limit the turning of the plug as in the Mueller patent and claim; and it has a handle for operating the plug, as called for by the Mueller patent and claim. The cock * * * has therein the construction and operation of the Mueller cock, and operates in the same manner and attains the same result as does the cock of the Mueller patent, * * *.

"The general operation set forth in the Mueller specification to which my attention is called in the question is the same as found in the prior art, as disclosed by the exhibits to which reference has been made. The prior patent shows that it is old to slip a cap onto the square end of the plug in such position that the stops may swing in the right direction to permit the plug to open. The prior patents disclose that it is old to connect a handle to a socket, so that when the handle is turned the valve will open and so that when the handle is turned the waste hole of the plug will receive the back water, and such water will waste through the waste hole of the plug and shell. The prior art also discloses that when the plug is completely open the stops will engage and arrest the motion of the handle and the plug, and this whether the valve plug is open for supplying water or is turned to open the waste. The prior art also shows that cocks which could be reversed and operate as right or left hand cock was an old idea in the art, so that, by turning the cock end for end and replacing the same in position to permit a reverse turn of the plug and securing the handle in proper position, the cock would operate. The prior art discloses that every feature of operation set forth for the operation of the Mueller cock was old and well known in the cock of the prior art as disclosed by the exhibits in evidence."

Mr. Robert H. Wiles, an expert on behalf of complainant, states the requirements of an interchangeable right and left stop and waste cock to meet the demands of the practical art of the plumber's trade as shown by the testimony, and summarizes such requirements as follows:

"First, the cock must be provided with stops limiting the partial rotation of the plug in any given operation to approximately 90 degrees.

"Second, in setting the cock the waste hole of the shell must be in front.

"Third, the cock must be of such construction that it may be set in either the right-hand or left-hand position, and its parts may be adjusted so that when the plug is in position, to permit the normal flow of water the handle will be parallel to the body or casing of the cock, and when the plug is in position to stop the flow of water and permit the wasting of the water from the proper part of the pipe the handle will stand at right angles to the shell or body of the cock.

"Fourth, the cock must be of such construction that when it is installed in the line of pipe, either the left-hand or the right-hand position, the waste hole of the plug will be presented rearwardly (that is, away from the waste hole of the casing or body) when the plug is in position to permit the normal flow of water through the pipe; and, as the plug is rotated from this position into the position to permit waste of the water from the proper portion of the pipe, the handle must swing forward and not backward.

"Fifth, the cock must be of such construction that it may be inserted in a line of pipe without reference to the direction of flow of water in the pipe; and its parts must be so adjustable as to adapt it for wasting the water from the pipe on either side of the cock when the handle is at right angles to the body of the cock—the cock being adapted to permit the normal flow of water through the waterway of its plug when the handle is parallel to the body or casing."

He then explains at length the patent in suit, compares it with the prior patents and the Cadbury exhibit put in evidence by the defendant, and says that the device of the patent in suit as made by complainant and that manufactured by the defendant in alleged infringement thereof are the only ones that do or that can be made to represent all of the requirements thus stated by him. He reaches this conclusion upon the fact alone that the cap and handle of the Cadbury exhibit and of others of the patents are made in one piece, or "integrally" as he terms it. He concludes his opinion upon this point as follows:

"The fact is, however (as has been clearly demonstrated), that the employment of an integrally-formed cap and handle like that of the German patent, or the Haines, Jones & Cadbury exhibit, is fatal to the proper operation of an interchangeable right and left stop and waste cock; and no structure anticipating the Mueller device of the patent in suit can be produced by adding such a one-piece cap and handle to the Kennedy stop and waste cock or to any other exhibit of the prior art in evidence herein."

The opinions of equally competent experts resting upon the same facts and so directly opposed to each other afford little aid in determining the question at issue. It must therefore be determined from the facts shown by the testimony.

That the cap of the Poppenburg or German patent of 1889, and of the Hirsch and Walsh patents, are designed to, and do in fact, inclose and securely protect the stop bearings and keys of the devices of those patents to the same extent and in substantially the same way that the cap of the patent in suit protects and secures its bearings, is not disputed; but the handle of the Poppenburg device, and of some others of the patents where it is referred to, is made integrally with the cap, and this is said to be fatal to the proper operation of an interchangeable right and left stop and waste cock. The Poppenburg device is not a waste cock, and of course is not intended as an interchangeable device. That of the Kennedy patent is, and may be operated by any suitable handle; that in other respects it anticipates the complainant's device is not seriously disputed; and, if the Cadbury exhibit can be

operated to meet the requirements stated by Mr. Wiles with its cap and handle made integrally, it seems clear that that device, not to name others, anticipates the patent in suit. The validity of complainants' patent, therefore, rests upon the fact alone, as stated by its expert Mr. Wiles, "that the employment of an integrally-formed cap and handle like that of the German patent or the Cadbury exhibit is fatal to an interchangeable right and left stop and waste cock." If this is true, there is nothing in the specification or claim of the patent in suit to indicate that the patentee intended to improve upon the prior devices by the use of a cap and handle made separately from but adjustable to each other, or that he intended to secure any such result in describing his invention or in the claim of his patent. The opening statement of the specifications negatives any such intention, and it is not "particularly pointed out or distinctly claimed" as a part of his invention. But admitting that the patentee is entitled to all of the uses to which his invention may be applied, whether or not he describes such uses (*Miller v. Eagle Co.*, 151 U. S. 186, 201, 14 Sup. Ct. 310, 38 L. Ed. 121), and that the adjustment of the handle and cap to each other is one of such uses, it is clearly anticipated by the Van Wie patent of 1891, which points out that the cap and handle are made separately, and that the handle, C, is adjustable with the cap or washer, C, which fits over the end of plug, B, substantially as in the patent in suit; also by the Bailey & Grace patent of 1892, the claim of which calls for "* * * the combination with the plug of an attachable and adjustable handle, a collar set on a plug and movable therewith * * * having a tongue adapted to be moved separately from the handle and adjustable in either of two positions ninety degrees apart, and stops on the shell to limit the movement of the tongue." Furthermore, the making in one piece of that which is in two, or in two pieces that which is in one, when the function of the device is not changed, is not invention, but the work of the mechanic only. *Howard v. Detroit Stove Works*, 150 U. S. 164, 169, 170, 14 Sup. Ct. 68, 37 L. Ed. 1039; *Standard Castor & Wheel Co. v. Castor Socket Co.*, 113 Fed. 162, 51 C. C. A. 109.

Is it true, however, that the Cadbury exhibit cannot be properly operated as an interchangeable right and left stop and waste cock with a cap and handle integrally formed? Complainant has prepared what it calls an illustrative exhibit upon which it has mounted two pairs of stop and waste cocks, each pair fitted to pipe set on a board. One of the pairs, the lower, is of complainant's stop and waste cocks as made by it, set in right and left hand positions, and in those positions it is claimed that each responds to all of the requirements of an interchangeable right and left stop and waste cock as stated by Mr. Wiles. The other pair, the upper, is made by complainant to represent the Cadbury exhibit, and is claimed to be set in right and left-hand position, and, as set, the right-hand device, it is conceded, responds to all of the requirements stated by Mr. Wiles; but complainant contends that the other does not, because, as it says, the handle of this cock when the flow of water through the pipe is unobstructed is crosswise to or at right angles with the line of pipe, and when the water is shut off the handle is in line with or parallel to the pipe. This contention

cannot be sustained because (1) this device as set upon the board is set in right-hand position, that is, for the flow of water from right to left if the board is set horizontally, or from below upward if set vertically, this being indicated by the position of the waste opening of the plug when brought into line with the waterway through the pipe; (2) the device can be set as a left-hand cock, that is, for the flow of water from left to right when the board is in a horizontal position or from above downward when in a vertical position, with the handle in line with the pipe when the flow of water is free, and crosswise to the pipe when shut off. This may be done as follows: When the handle is in line with the pipe, remove the handle and cap and rotate the plug 180 degrees in either direction, which will bring the waste opening of the plug in the opposite direction; reset the handle and cap with the handle out and crosswise to the pipe, then turn the handle down, and this will present the waste opening of the plug rearwardly, or opposite to the waste opening of the shell, and bring the waterway of the plug in line with the opening through the pipe, and the device is thus changed to a left-hand position, in which it was probably intended to be, and readily can be, set upon a board, and will respond to all of the requirements stated by Mr. Wiles for such a device when so set. That both complainant's device and the true Cadbury exhibit in evidence, or the one prepared by complainant for its illustrative exhibit, may be originally installed in either a right or left hand position as the direction of the flow of water through the pipe may require, seems clear and to be conceded by complainant; but its contention is that, if the Cadbury exhibit be set in a right-hand position when a left-hand cock is required, or vice versa, it cannot be changed to operate in the other position without taking it out and resetting it; and this it attempts to demonstrate by this illustrative exhibit. If the Cadbury cocks upon that exhibit are true Cadbury cocks, its contention may be correct, providing the location, form, and number of the adjustable bearings are an essential feature of the device and of the complainant's patent. The defendant, however, contends that the Cadbury cocks upon complainant's illustrative exhibit are not true Cadbury cocks; that the plug or key is that of complainant's device set in a Cadbury shell. Just what the construction of the Cadbury plug as made by complainant for that exhibit is does not appear in evidence, save by the plug itself, and that Mr. Philip Mueller, superintendent of the complainant company, says that he had them made to represent the Cadbury cock because complainant had none of that manufacture, but it is not disclosed from what source he obtained the pattern for the plug or key of this device. The function of the waste opening of the plug in the Cadbury exhibit, as it is in complainant's and the other devices in evidence, is to drain the water from the proper portion of the pipe when the flow is shut off. It is obvious that this may be done as effectually if the waste opening of the plug is at a proper distance either side of its longitudinal center as when it is in the center. This will readily suggest itself to any ordinary mechanic upon examining the devices; and it is so made in the Kennedy cock of 1884, and defendant's stop and waste cock of 1883, and the Ohio cock, and perhaps

others. If such waste opening is in the longitudinal center of one wall of the plug, then it may come into register with the waste opening of the shell or outer case of the device; hence the rule, as stated by Mr. Wiles, that the waste opening of the plug must be presented rearwardly, or to the back of the shell, when the flow of water is unobstructed through the pipe, in order to prevent its escape through the waste port of the shell. If, therefore, the waste opening of the plug is at one side of, and not in, its longitudinal center, it can never come into register with the waste opening of the shell, and it can be presented to the front as well as to the rear of the shell without the danger of water escaping through it, as it would if it was in line with the waste opening of the shell; and when shut off the water will drain from the proper portion of the pipe through the waste opening of the plug into the water way thereof and escape through the waste port of the shell. This will more clearly appear by reference to the Cadbury exhibit, the Kennedy cock of 1884, defendant's stop and waste cock of 1883, the Ohio cock, or the drawings of complainant's patent or to its device. The waste opening in the plug of the true Cadbury exhibit in evidence is not in the longitudinal center of the plug, but is at one side thereof, so that in rotating the plug its waste opening can never come into register with the waste opening of the shell. It is the contention of the defendant's counsel that this construction of the plug of the Cadbury exhibit was not observed by complainant when it prepared the so-called Cadbury cocks for its illustrative exhibit, and that this is the reason why those cocks cannot be changed from left to right hand position or vice versa, after having been installed in the pipe without taking them out and resetting them, or so changing the adjustable bearings as to permit of such interchange. This contention seems to be correct. Certain it is that the waste openings of the plugs in the so-called Cadbury cocks upon complainant's illustrative exhibit are in the longitudinal center of the plugs and will register with the waste ports of the shells the same as do those in complainant's device. It is equally certain that if they were at one side and not in the center of the plug, and could not come into register with the waste ports of the shells, they could be changed to right or left hand position as the direction of the flow of water through the pipe might require without taking them out and resetting them. This may be readily demonstrated with complainant's illustrative exhibit. The upper right-hand Cadbury cock of that exhibit is set in right-hand position; that is, for the flow of water upward when the board is in vertical position, or from right to left when in horizontal position. Assume the flow of water through this device to be from the opposite direction, also that the waste opening of the plug is at one side of, and not in its longitudinal center, and cannot be brought into line with the waste port of the shell, then it may be changed to a left-hand position without taking it out and resetting it in the following manner, viz.: While the handle is in line with the pipe and the waterway open, remove the handle and cap, and rotate the plug 180 degrees in either direction; this will bring the waste opening of the plug in the opposite direction from what it was; then reset the handle and cap in the same position as before; this

leaves the waterway open, and brings the handle in line with or parallel to the pipe and the waste opening of the plug towards the front of the shell, but as it is not in line with the waste port of the shell the water cannot escape through it; then turn the handle outwards or away from the pipe, the only way that it can be moved, and the flow is shut off; the water in the other portion of the pipe will then drain through the waste opening of the plug into the waterway thereof and escape through the waste port of the shell as before; the device is thus changed to a left-hand position. The other cock, if properly set in left-hand position, may be changed to a right-hand position in the same way.

The testimony shows that the cap of the complainant's cock as made by it is not made according to the drawings of the patent, but has the rib 7 shown in Fig. 3 of those drawings cut away to form two additional adjustable stop bearings 8, opposite to those shown in that figure, so that there are four adjustable stops in the interior of the cap as made, instead of two as shown in the drawings; also upon one corner of the shank 3 of the plug is a lug or projection, and the square opening in the cap is recessed or cut away in two of its corners to receive this projection. Mr. Wiles is of opinion that these are but immaterial variations or details of construction that do not affect the principle of the device; and in this he seems to be correct as to the bearings at least, for neither the specifications nor the claim of the patent locate or fix the number or form of these bearings in the interior of the cap, and such bearings may be increased to any number requisite to the proper operation of the device and their form and location fixed to secure this result. This would not be invention, but the work of the mechanic only. *Howard v. Detroit Stove Works*, 150 U. S. 164, 167, 14 Sup. Ct. 68, 37 L. Ed. 1039; *Cimiotti Co. v. Am. Fur Co.*, 198 U. S. 399, 414, 25 Sup. Ct. 697, 49 L. Ed. 1100. It is obvious, however, that the two additional stop bearings increase the adjustable capacity of the cap upon the shank 3 of the plug, and permit such adjustment to an extent approximately of 180 degrees instead of 90, while limiting the rotation of the plug to an extent of 90 degrees in opposite directions from the permanent stop bearing 11 upon the shell. But if the additional bearings and form thereof are mere details of construction, not affecting the principle of the device, the same rule must apply to the Cadbury and other exhibits of the prior art, and there can be no doubt that the depending rim or flange of the cap of the Cadbury device can be cut away to form additional bearings and permit their adjustment to the stops upon the shell so that it can be changed to a right or left hand position after being installed in the pipe according as the direction of the flow of water may require, even with the waste hole of the plug in its longitudinal center as it is in complainant's device, instead of at one side as it is in the true Cadbury exhibit. Be this as it may, it is plain that the true Cadbury exhibit is an interchangeable right and left stop and waste cock responding to all of the requirements of such a device as stated by Mr. Wiles, though its handle and cap are made integrally instead of in two pieces. Any handle that will fit the socket of the shank 3 of the

plug of complainant's device will effect its interchange from a right to a left hand position, because that is effected by the rotation of the plug, and the cap through the plug; and the only function of the handle is to rotate them and indicate whether or not the flow of the water is free through the pipe, and this function is as effectually performed by the handle of the Cadbury exhibit as by that of the complainant's device.

Finally, it is urged that the cap of the Cadbury exhibit does not inclose and protect the adjustable and permanent stop bearings of the device, and that such inclosure and protection are essential features of the complainant's patent. The claim of the patent for "stop bearings in the cap adapted to entirely inclose and strike the stop projections of the shell" is not aptly expressed, and it may be doubtful, to say the least, if this claim conforms to the statutory requirements. It is probably intended for "stop bearings entirely inclosed in a cap, and adapted to strike the projections of the shell." For the purpose of this hearing it may be considered as so expressed. If the Cadbury cap was the latest development of the art in this respect prior to the complainant's patent, it might well be held that the cap of the complainant's device was such an improvement upon the Cadbury cap as would sustain that feature of the patent in suit. But the Hirsch patent of 1883, the Walsh patent of 1886, and the Poppenburg or German patent of 1889, are each intended to inclose the bearings and prevent the access of sand and grit to the interior construction of the device, while the drawings of other patents show the device to be covered with a hood or cap that do so inclose and protect them. If in the actual construction of the devices they do not do so as securely as the complainant's cap, the fault is in the workmanship and not in the design of the caps, as that is intended that the caps shall inclose and securely protect them, and the skilled workman will so make them. In fact, the cap alone of the Poppenburg patent of 1889 by properly adjusting its stop bearings and making it and the square opening therein of the proper size, can be transferred to complainant's device, and it will perform in that position all of the functions of the complainant's cap.

Mindful of the rule that in the law of patents it is the last step that wins (*The Barbed Wire Patent*, 143 U. S. 275, 283, 12 Sup. Ct. 443, 36 L. Ed. 154), and that a simple or slight improvement of a prior device if it substantially changes the prior one, or is such that a new result is produced, or an old result attained in a more economical and efficient way, is sufficient to sustain a patent for such improvement (*Seymour v. Osborne*, 11 Wall. 516, 20 L. Ed. 33; *National Hollow B. B. Co. v. Interchangeable B. B. Co.*, 106 Fed. 693, 707, 45 C. C. A. 544), a patient study of the complainant's patent and comparison of it with the earlier patents and devices in evidence leads to the conclusion, that the patent in suit is not a step in advance of the prior inventions and well-known devices, and that its alleged improvements are anticipated by the Cadbury exhibit with the cap of the Poppenburg or German patent of 1889, and the Kennedy patent of 1884, not to mention others of the patents in evidence. The bill should therefore be dismissed at complainant's cost, and it is so ordered.

H. MUELLER MFG. CO. v. A. Y. McDONALY & MORRISON MFG. CO.

(Circuit Court, N. D. Iowa, E. D. October 14, 1908.)

No. 236.

1. TRADE-MARKS AND TRADE-NAMES (§ 65*)—INFRINGEMENT.

Complainant and defendant were each manufacturers of plumbers' supplies, and complainant adopted as a trade-mark the letters "H M" which it marked on its goods in a shield-shaped space with the figure of a diamond between the letters. Defendant used the letters "M M," which were the initials of the principal words in its corporate name, placed within a diamond-shaped space. It had used the diamond, both the word and figure, to denote its business and goods for many years before complainant's trade-mark was adopted. *Held*, that the similarity between the two marks was not such as to deceive purchasers using reasonable care or to charge defendant with infringement.

[Ed. Note.—For other cases, see Trade-Marks and Trade-Names, Cent. Dig. § 64; Dec. Dig. § 65.*]

2. TRADE-MARKS AND TRADE-NAMES (§ 75*)—UNFAIR COMPETITION—IMITATION OF FORM OF MANUFACTURED ARTICLES.

A defendant manufacturing stop and waste cocks and similar plumbers' supplies which procured such articles of complainant's manufacture and purposely imitated them in size, shape, and appearance, thereby causing confusion in the trade and in fact deceiving purchasers, *held* chargeable with unfair competition which entitled the complainant to an injunction.

[Ed. Note.—For other cases, see Trade-Marks and Trade-Names, Cent. Dig. § 86; Dec. Dig. § 75.*]

Unfair competition, see notes to *Scheurer v. Muller*, 20 C. C. A. 165; *Lare v. Harper & Bros.*, 30 C. C. A. 376.]

In Equity. On final hearing.

For opinion denying motion for preliminary injunction, see 132 Fed. 585.

The parties to this suit are the same as in No. 235, just decided, and it is to restrain an alleged infringement of a trade-mark, unfair competition in trade, and for an accounting. Defense, noninfringement and denial of the alleged unfair competition.

Bond, Adams, Pickard & Jackson and M. M. Cady, for complainant.

Thos. A. Banning, Banning & Banning, and Hurd, Lenehan & Kiesel, for defendant.

REED, District Judge. The complainant and defendant are rival manufacturers of, and dealers in, plumbers' goods. The controversy was before the court at a former date upon application by complainant for a preliminary injunction, which was denied. *H. Mueller Mfg. Co. v. A. Y. McDonald & Morrison Mfg. Co.* (C. C.) 132 Fed. 585. It was there said:

"The letters adopted by the complainant and defendant as their respective trade-marks are the initials of the principal words or names comprising the corporate name of each. Assuming, without deciding, that complainant had acquired the prior right to the use of its trade-mark, the defendant has the right to use its own name or the initial letters thereof as a part of its trade-mark to indicate its own goods, providing it does not do so in a manner and form to mislead the public and deceive buyers as to the identity of the goods,

*For other cases see same topic & § NUMBER in Dec. & Am. Digs. 1907 to date, & Rep'r Indexes

and lead them to believe that defendant's goods are those of complainant's manufacture. * * * The burden is upon complainant to establish by clear and satisfactory proof the fraudulent intent and purpose of the defendant in arranging or using the initials of its own name in the form and manner it has, and placing the same in such form upon its own goods to so mislead and deceive dealers in and consumers of such goods."

See, also, *Brown Chemical Co. v. Meyer*, 139 U. S. 544, 11 Sup. Ct. 625, 35 L. Ed. 247.

The correctness of the rule thus stated is not controverted by either party, but complainant maintains that the final proofs show that defendant does so use the initial letters of its own name in connection with the figure of a diamond and the shape or form and dress of its stopcocks, stop and waste cocks, and inverted key curb cocks manufactured by it as to simulate the complainant's goods of that class, and to thus fraudulently and unlawfully trespass upon its rights. The complainant caused its trade-mark to be registered in the Patent Office November 30, 1897, and its essential feature as there stated is, "the letters H and M arranged to make and form a part of the pattern of its fluid transmission appliances, particularly valves, cocks, pressure regulators, and tapping machines," and it is stated that complainant and its predecessors in trade have used this trade-mark since 1887. No reference is made to a figure of any kind as a part of the trade-mark. As used upon some of its goods of the above class the letters are arranged upon a figure designated in the evidence as "a shield" raised or embossed upon one side of the device, and upon its stop and waste cocks the nozzle or waste port of the shell is in the center of the figure with one of the letters on each side of the nozzle.

The defendant's trade-mark which it has adopted, and which it is alleged infringes complainant's, consists of the initial letters of the principal names comprising its corporate name arranged upon the figure of a diamond raised or embossed upon one side of its goods. These initial letters were first adopted and used by it in about 1900, and upon the stop and waste cocks manufactured by it since that time the nozzle or waste port of the shell is in the center of the raised figure with one of the initial letters arranged on each side thereof. The following cuts show substantially the trade-mark of the complainant, and that of the defendant as used by it since about 1900, and the style of letter in each as they appear upon the goods of their respective manufacture as above stated:

Complainant's Trade-Mark.



Defendant's Trade-Mark.

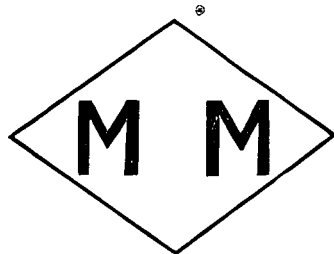

The defendant and its predecessor A. Y. McDonaly have used the figure of a diamond upon goods manufactured by them since 1855 or 1856, and upon the wall of defendant's shop or factory in Dubuque, built in 1877 or 1878, a sign was painted when the building was erected, with the word "Diamond" upon it, and a figure of a diamond in the form above shown at each end of the word. The sign still appears upon the building. The figure of a diamond and the name, or the initial letters thereof, have been continuously used by them ever since in one form or another upon goods manufactured by them, though they have not always been placed upon all of the goods. The placing of the initial letters of the names of the manufacturers of plumbers' goods upon the goods made by them is a custom or practice that far antedates the practice of the complainant or defendant to do so, and each but followed an old and well-known custom in placing the initial letters of its name upon the goods. In later years defendant has largely manufactured plumbers' goods for jobbers, and upon some of these the figure and defendant's name or the initial letters thereof have been omitted at the request of the jobbers and the jobber's name stamped upon the goods. It is contended by complainant that prior to about 1898 the defendant had abandoned the use in any form of the figure of a diamond as a part of its trade-mark, and that whatever right it had acquired before to so use the same it then lost, and that the use of it since that time is subsequent to the adoption by complainant of the so-called figure of a shield as a part of its trade-mark. Without reviewing the testimony bearing upon this question, it must suffice to say that it does not sustain complainant's contention, and that it conclusively shows that the continuous use by defendant and its predecessor in business of the figure of a diamond in one form or another as a part of their trade-marks began long prior to the adoption by complainant of its so-called figure of a shield as a part of its trade-mark, and that there has never been any intention by either of abandoning its use as such. *Saxlehner v. Eisner Co.*, 179 U. S. 19-31, 21 Sup. Ct. 7, 45 L. Ed. 60.

Does the arrangement by defendant of the initial letters of its corporate name in connection with the figure of a diamond placed horizontally upon plumbers' goods made by it infringe the complainant's trade-mark? Remove the trade-mark of complainant and defendant from the article of manufacture upon which each is impressed and examine them separately, and it is quite apparent that no one exercising the slightest diligence in inspecting them could be deceived or led to believe that they were the same or that one was made in imitation of the other. A purchaser of goods is required to exercise reasonable care in examining them to ascertain that he gets what he wants, and a dealer is not required, in adopting a trade-mark or in dressing his goods, to select a mark, or so dress the goods that under no circumstances can a careless purchaser be misled or deceived. All that fair dealing requires is that the dealer shall adopt such a mark, or so dress his goods, that an ordinary person exercising reasonable care to guard against imposition will not be beguiled into purchasing an article that he does not intend to purchase. *Coats v. Merrick Thread Co.*, 149 U. S. 572,

573, 13 Sup. Ct. 966, 37 L. Ed. 847. It is obvious that the difference between the complainant's trade-mark and that of the defendant is such that the latter does not infringe the former.

Irrespective, however, of any question of trade-mark, rival dealers have no right to dress their goods in simulation of those of their competitors, or by imitative devices mislead the purchasing public into buying their goods in the belief that they are those of their rivals in trade. *Coats v. Thread Co.*, 149 U. S. 562, 13 Sup. Ct. 966, 37 L. Ed. 847. There is no doubt that the form and general appearance of the defendant's stop, stop and waste, and inverted key curb cocks, including the caps and handles as made by it since about 1898 or 1900, are identical with those of the complainant; and the impress of defendant's trade-mark upon any of such goods does not distinguish them from those of the complainant. While a dealer familiar with the goods of both, upon a close or critical examination of them when side by side, would readily distinguish one from the other, the ordinary purchaser, or dealer even, when examining them apart from each other and exercising due care to distinguish between them, would readily select one for the other. The proofs show, however, that aside from the cap and handle the outward shape or form of the body or shell of the stop and stop and waste cocks of both complainant and defendant were in common use and clearly described and shown in cuts published in catalogues of plumbers' goods as early as 1877, or 20 years before the complainant registered its trade-mark, and long before it began making its stop and stop and waste cocks in the shape or form that it now makes them. The defendant's exhibit of its 1883 stop, and stop and waste cocks, aside from the handles (they have no caps), the Farnan pattern of 1885, and the Ohio cock are identical in shape with the body or shell of complainant's goods of that class and of the goods of other manufacturers, as shown in the exhibits and published catalogues of such goods as early at least as 1877, and complainant has no more right to appropriate that shape or form of the body or shell of such goods to its exclusive use than has the defendant or any other manufacturer of such goods. But in about 1900, or not earlier than 1898, the defendant began making a cap and handle identical in size and shape with those of the complainant, and placed them upon the body or shell of stop, and stop and waste, cocks of the shape and size in common use generally by manufacturers of plumbers' goods long prior to 1894, and has since continued to make the handle and cap of its stop, and stop and waste cocks in that shape or form ever since; and with its trade-mark impressed upon the body of the cock they are not readily distinguishable from the complainant's goods of that class. In fact, the proofs show that a number of persons, since defendant began making its goods in that form, have purchased its goods of that class believing them to be of complainant's manufacture. The testimony is quite persuasive that defendant in adopting this form or shape and size of its cap and handle did so to imitate and simulate the cap and handle of the complainant. In so doing it wrongfully trespassed upon complainant's rights, and is guilty of unfair competition in trade.

It is urged on behalf of defendant that it has the right to use the essential form or shape and size of a cap and handle for its goods. Grant it; but the exact size, form, and outward appearance or dress of the cap and handle are not essential features of these devices. The outward form, and dress or appearance, of the articles are purely arbitrary and fanciful. The exterior of the cap may be square, hexagonal, or octagonal, and the shape of the handle square or of some other form that will readily distinguish it from that of the complainant, and yet each possess all the essential elements or features of a cap and handle suitable for the goods of that class and be readily distinguishable from another cap and handle performing the same function. The complainant began the manufacture of its inverted key curb cock with a T-shaped handle in about 1894. In 1900, or 1898 at the earliest, the defendant procured one of them and began making its goods of that class in exact imitation of the complainant's, even to the color of the handle and the size and location of an arrow on the barrel of the device, but impressed its trade-mark upon the body of the cock. This, however, fails to distinguish it from the complainant's. The proof is conclusive that defendant did this to simulate the complainant's goods of that class. Defendant, in so simulating the cap and handle of complainant's stop, and stop and waste, cocks, and its inverted key curb cock, creates confusion between its goods and those of complainant of those classes to the damage of the complainant, and it may be to the injury of the purchasing public.

The conclusion, therefore, is that, while the defendant may rightfully use the figure of a diamond, and the initial letters of the principal names comprising its corporate name, substantially as arranged by it as its trade-mark, and impress the same upon the goods of its manufacture, including the body or shell of its stop, and stop and waste, cocks, it may not make the cap and handle it places upon such goods in simulation of the complainant's cap and handle, nor its inverted key curb cock in simulation of that of the complainant, with or without the impress of its trade-mark thereon, and a decree may be prepared restraining it from so doing and for an accounting.

It is ordered accordingly.

H. C. COOK CO. v. LITTLE RIVER MFG. CO.

(Circuit Court, D. Connecticut. November 19, 1908.)

No. 1,123.

EQUITY (§ 410*) — FINDINGS OF MASTER—EXCEPTIONS—SUFFICIENCY—DAMAGES RECOVERABLE.

The findings of a master as to the amount of damages recoverable by a complainant for infringement of a patent affirmed as against general exceptions which did not point out any evidence to impeach the same.

[Ed. Note.—For other cases, see Equity, Cent. Dig. § 910; Dec. Dig. § 410.*]

*For other cases see same topic & § NUMBER in Dec. & Am. Digs. 1907 to date, & Rep'r Indexes

In Equity. On exceptions to master's report.
See, also, 136 Fed. 414, and 156 Fed. 676.

George D. Seymour and Munger & Munger, for complainant.
Williams & Harriman, for defendant.

PLATT, District Judge. This is a patent suit which has had a checkered career in our courts, and has now reached the stage where, if the master's report shall be accepted, a final decree will immediately follow.

In his report filed July 22, 1907, the master finds, "from the great mass of data produced by the defendant," that it manufactured and sold 2,681½ gross of infringing Apt Clippers. He also finds, "from the data furnished by defendant and from an analysis of the books of the complainant," that \$3,931 is a "fair and reasonable net profit per gross" on complainant's clippers which would have been sold except for the infringing sales. A simple sum in arithmetic makes the total damages in this respect \$10,540.95. This conclusion is reached by eliminating interest, but including taxes and insurance. He also finds that, "as a direct result of defendant's competition, complainant was forced to reduce its price for the sale of the Gem Clippers," and that because of said forced reduction it was further damaged \$2,330.85.

The court has before it this plain report, unadorned, unembellished, and without complication, and yet the defendant, by its receiver, has filed 50 exceptions thereto. On the threshold of the argument upon the exceptions, the counsel for the receiver admits that the situation before the master made it impossible for him to arrive at any conclusion as to the profits or losses made by the defendant on its infringing sales, and that the master heard the case after and upon a distinct concession by the receiver that "the plaintiff might recover the amount of profits which it would have made had it manufactured the goods sold by the defendant." The master was then placed by the parties themselves where he had only two questions to decide: (1) How many infringing clippers did the defendant sell? (2) What net profit would have accrued to the plaintiff if it had sold an equal number of its own patented clippers? All exceptions, therefore, which relate to the matter of defendant's losses or profits on the infringing sales are manifestly irrelevant, and must be overruled.

The other class of exceptions touch upon the master's findings upon the net profits which plaintiff would have made if it had sold its own clippers to the customers who bought the infringing clippers. The basic trouble with such exceptions is that they are irregular and without foundation to rest upon. The attention of the court is not directed to any testimony taken by the master from which it can be determined that the master was mistaken in any of his inferences and conclusions. I am sure that I may say, without being charged with irreverence, that to me they appear to be "without form and void." The evidence is not in fact before me, but if it were, no reference is made to any portion of it, nor indeed to it as an entirety. Verily, darkness is upon the face of the deep. The brief used at the hearing cannot take the place of the exceptions. Sound equity practice would

be engulfed in a quagmire if such exceptions as those under discussion were given any force and vitality. It is not pleasant to say these words. I did not create the situation which confronts me, but it exists by reason of the time-honored rules of law and equity, and I should deem myself recreant to my trust if I permitted the least relaxation of those rules because thereby a result might be reached which would be a soothing comfort to my personal views of the contention which has raged before me for a long, long time. I am bound hand and foot, and am constrained to accept the report of the master, which I think is able, fair, and conclusive.

Let a decree be entered, with costs, fixing the damages at \$12,871.80.

MCDONALD v. CLEARWATER SHORTLINE RY. CO.

(Circuit Court, D. Idaho, N. D. July 18, 1908.)

1. BANKRUPTCY (§ 165*)—VOIDABLE PREFERENCE—TRANSFER AS SECURITY FOR LOAN.

Property transferred by a borrower at the time of receiving a loan and for the purpose of making the lender safe is security, and the validity of the transfer, if not accompanied by positive fraud, is recognized and enforced in bankruptcy.

[Ed. Note.—For other cases, see Bankruptcy, Cent. Dig. § 259; Dec. Dig. § 165.*]

2. BANKRUPTCY (§ 160*)—VOIDABLE PREFERENCE—PROOF OF INSOLVENCY.

The fact that a corporation engaged in the performance of a contract which required a considerable expenditure before it was entitled to payment thereunder arranged with a bank for making overdrafts is no evidence that it was insolvent at the time within the meaning of Bankr. Act July 1, 1898, c. 541, § 1, subd. 15, 30 Stat. 545 (U. S. Comp. St. 1901, p. 3419).

[Ed. Note.—For other cases, see Bankruptcy, Dec. Dig. § 160.*]

3. EVIDENCE (§ 43*)—JUDICIAL NOTICE—PROCEEDING IN OTHER COURTS—RECORD IN BANKRUPTCY PROCEEDING.

In a plenary action in a Circuit Court by a trustee in bankruptcy, the court cannot take judicial notice of matters of record in the District Court in the bankruptcy proceedings.

[Ed. Note.—For other cases, see Evidence, Cent. Dig. § 65; Dec. Dig. § 43.*]

4. BANKRUPTCY (§ 166*)—VOIDABLE PREFERENCE—SUFFICIENCY OF EVIDENCE.

Evidence considered, and *held* insufficient to establish the insolvency of a corporation at the time it made an assignment of a debt due it to a bank as security for past and future overdrafts, or that the bank had reasonable cause to believe that a preference was intended, so as to render the transfer a voidable preference on the bankruptcy of the corporation.

[Ed. Note.—For other cases, see Bankruptcy, Cent. Dig. §§ 255-257; Dec. Dig. § 166.*]

5. SALES (§ 201*)—EFFECT—TRANSFER OF TITLE—DELIVERY AND ACCEPTANCE.

A lumber company which was under contract to furnish ties to a railroad company hauled a number of ties and piled them on the railroad company's right of way, where they were inspected, accepted, and marked by its agent in the presence of the secretary of the lumber company, and a certificate or invoice was issued therefor. *Held*, that there was such delivery as to pass title, which was not affected by a subsequent at-

*For other cases see same topic & § NUMBER in Dec. & Am. Digs. 1907 to date, & Rep'r Indexes

tachment of the ties by a creditor of the lumber company nor by any action of the court in subsequent bankruptcy proceedings against such company.

[Ed. Note.—For other cases, see Sales, Cent. Dig. §§ 529-541; Dec. Dig. § 201.*]

6. SALES (§ 202*)—PASSING OF TITLE—NECESSITY OF PAYMENT.

A lumber company was under contract to furnish ties, and hauled a number and piled them on the purchaser's right of way, where they were inspected and accepted and invoice issued therefor. *Held*, that there was such a delivery as passed title, though payment had not been made therefor at the time of a subsequent attachment in bankruptcy proceedings, there being no requirement in the contract that title should not pass until payment.

[Ed. Note.—For other cases, see Sales, Cent. Dig. §§ 542, 545; Dec. Dig. § 202.*]

7. SALES (§ 442*)—ACTION FOR PRICE—COUNTERCLAIM.

By a contract by which a lumber company agreed to furnish a stated number of ties to a railroad, it was provided that the seller should convey a good and unincumbered title, and in case of legal proceedings against the purchaser for any of said ties or their value or to establish any lien thereon it should indemnify and hold harmless the purchaser from all loss, damages, and legal expenses thereby incurred. After certain ties had been delivered to and accepted by the railroad company, an action of trespass was brought against it and the lumber company by the United States to recover the value of certain of the ties which had been unlawfully cut and removed from government land. *Held*, that the amount recovered and the expense and costs of such action paid by the railroad company were recoverable by it by way of counterclaim from the lumber company, but that costs and expenses incident to a wrongful attachment of the ties by a creditor of the lumber company after title had passed to the railroad company were not so recoverable.

[Ed. Note.—For other cases, see Sales, Cent. Dig. § 1296; Dec. Dig. § 442.*]

At Law. Trial to the court without a jury.

I. N. Smith, for plaintiff.

James E. Babb, for defendant.

DIETRICH, District Judge. On August 1, 1899, the Clearwater Land, Log & Lumber Company, hereinafter referred to as the lumber company, entered into a written contract with the defendant, hereinafter referred to as the railroad company, by which the former was to furnish to the latter, between the date of the contract and July 20, 1900, 300,000 cross-ties, at prices therein specified. Prior to January 1, 1900, deliveries were made aggregating 20,026 ties, upon account of which some payments were made, leaving due to the lumber company a balance of \$378. On or about January 20, 1900, another delivery was made of 11,305 ties, invoicing \$3,302.52, at the contract price.

For some time after the contract was executed, the lumber company transacted its banking business with the Kendrick State Bank, but, for reasons which it is not necessary to determine, early in January, 1900, it proposed to J. B. Johnston, who was doing business in the name of the Orofino Banking Company, that it open an account with him, and, accordingly, on January 9, 1900, an understanding was

*For other cases see same topic & § NUMBER in Dec. & Am. Digs. 1907 to date, & Rep'r Indexes

reached by which the lumber company was to do all its banking business with the Orofino Banking Company, and was to deposit therein its vouchers and drafts, and in turn was to be permitted to check against its account. In speaking of the understanding of that date, the witness J. B. Johnston, whose testimony is not contradicted, said:

"Well, they had desired to open an account with me—that is, with the Orofino Banking Company—and promised me that voucher as soon as the ties were inspected and delivered. They also said that they would do all their banking business with the Orofino Banking Company from that time on. They promised me this \$3,302.50 voucher from the railroad company."

The bank immediately began to honor the lumber company's checks, and at the close of business on the 18th day of January the overdrafts aggregated \$851.50. No other checks were paid until January 25th, upon which day the amount of the overdraft was practically doubled, and still no credits. For reasons which do not clearly appear, the lumber company, on January 21st, telegraphed to one John Willis, timber agent for the railroad company, at Brainerd, Minn., advising him that upon that day the railroad company's agent at Potlatch, where the ties were delivered, had received ties of the value of \$3,302.52, and requested him to issue a check for the amount to the Orofino Banking Company, explaining that the money was needed, and that the lumber company could get the money from the bank if the railroad company would agree to issue the voucher to the bank. On January 24th, Willis telegraphed to the bank from Duluth, advising the latter that the railroad company would accept the order of the lumber company for \$3,302.52, if properly drawn to cover the January invoice of ties, and upon the same day a formal order, directed to the treasurer of the railroad company, was executed by the lumber company and delivered to the bank. The receipt of this by Willis was acknowledged on January 28th, with the information that he had requested the treasurer to hurry the voucher forward. Other advances were thereupon made by the bank to the lumber company, almost all of which were prior to February 5th, and also some deposits to the credit of the lumber company, the excess of the debits over the credits being \$43.27 less than the \$3,302.52.

Whether any voucher for the \$3,302.52 was ever delivered to the bank is not made to appear, but, for some reason not disclosed, the railroad company did not, in accordance with the understanding of the parties, make payment to the bank; perhaps its failure in that respect is accounted for by current and subsequent events hereinafter referred to, which may also explain why credit for the amount of the promised voucher was not given upon the books of the bank.

Scarcely had the correspondence to which reference has been made taken place before the troubles of the lumber company began. The United States, claiming that they had been wrongfully cut upon public lands, seized the delivered ties, but a few days later released them, and took possession of other ties which had been cut but were still in the woods. Almost immediately thereafter, one of the creditors of the lumber company caused the 11,305 ties, for which the voucher was to be issued, to be attached by the sheriff of Shoshone county. Thereafter, on April 3, 1900, a petition in bankruptcy was filed by sev-

eral of the creditors of the lumber company, and accordingly an order adjudicating it a bankrupt was entered on June 8, 1900, and, in due time, a trustee was appointed. On or about June 29, 1900, the Orofino Banking Company assigned to the Exchange National Bank of Spokane its interest in the claim against the railroad company for the \$3,302.52, and upon September 5, 1902, the railroad company paid to that bank the full amount, less the sum of \$244.96, which had theretofore been paid by it to the United States in settlement of suits which had been brought against it and the lumber company for damages for alleged trespass in cutting and removing the ties from public lands.

Charles L. McDonald, the plaintiff herein, as trustee in bankruptcy for the lumber company, commenced this action against the defendant in the state district court on October 2, 1903. In his complaint he ignores the existence of the order or assignment of the lumber company to the banking company, and states a cause of action at law for the recovery, upon the contract referred to, of \$3,680.52, the same being the aggregate amount of the \$378 and the \$3,302.52. By proper proceedings the cause was removed to this court, and thereafter the defendant answered, pleading the assignment to the Orofino Banking Company and the payment by the defendant to the Exchange National Bank, and also setting forth certain items of counterclaim. A jury was waived, and the cause has been submitted for decision upon a stipulation of facts, together with the deposition of the banker, J. B. Johnston.

In plaintiff's reply brief he, for the first time, objects to the validity of the assignment by the lumber company to the bank, that the order or written assignment does not bear an internal revenue stamp. There must be some misapprehension in this respect, for in paragraph 7 of the stipulation of facts there is set forth a copy of the order or assignment, dated January 24, 1900, bearing this notation: "Int. Rev. Stamp 2 cts. affixed & cancelled 1/24/1900 C. L. L. & L. Co."

The principal and most serious contention urged by the plaintiff is that, assuming the assignment to have been valid between the parties, it constituted a preference under the bankruptcy law, and may therefore be avoided by the trustee in bankruptcy. By counsel for the defendant it is elaborately argued that, even if the assignment be deemed to be a preference, the plaintiff cannot proceed, in an action at law, upon the theory that it was absolutely void, but his remedy was by a suit in equity to set aside the assignment and recover the property, or the value of the property, thus transferred by the bankrupt. In consideration of the conclusion I have reached upon the merits, it is not necessary to determine whether such relief is grantable exclusively by a court of equity. Assuming, but not deciding, that the trustee has not mistaken his remedy, and further adopting the view, most favorable to plaintiff, that the rights of defendant are no greater than the bank would have, had the amount of the claim been paid to it, and had this action been brought against it to recover the amount so paid, should the plaintiff succeed? The transactions took place in 1900, and hence to the provisions of the general bankruptcy Act of 1898, prior

to amendment of 1903, we must look for the law. By subdivision 15 of section 1 of this act (Act July 1, 1898, c. 541, 30 Stat. 545 [U. S. Comp. St. 1901, p. 3419]) it is provided that:

"A person shall be deemed insolvent within the provisions of this act whenever the aggregate of his property, exclusive of any property which he may have conveyed, transferred, concealed, or removed, or permitted to be concealed or removed, with intent to defraud, hinder or delay his creditors, shall not, at a fair valuation, be sufficient in amount to pay his debts."

By subdivision "a" of section 60 it is provided that:

"A person shall be deemed to have given a preference if, being insolvent, he has procured, or suffered a judgment to be entered against him in favor of any person, or made a transfer of any of his property, and the effect of the enforcement of such judgment or transfer will be to enable any one of his creditors to obtain a greater percentage of his debt than any other of such creditors of the same class."

It is upon this latter provision that the plaintiff lays especial emphasis, and upon it mainly he relies for his right to recover. Undoubtedly the assignment under consideration was a "transfer" of "property." In order that the case may be brought within the scope of this subdivision, however, it was incumbent upon the plaintiff to show that the assignment was made when the lumber company was "insolvent," and, further, that the effect of such transfer was to enable the bank to obtain a greater percentage of its debt than any other creditor of the same class. That these conditions must appear is conceded by the plaintiff; and it is further conceded that a preference is not voidable unless it is given in satisfaction of an antecedent debt—that is, a debt which existed at the time the transfer was made. Property transferred by a borrower at the time of receiving a loan, and for the purpose of making the lender safe, is security; its validity, if unaccompanied by positive fraud, is recognized and enforced in bankruptcy. Transfers which do not diminish the estate of the bankrupt, but which constitute only a fair exchange of property, are not preferences. *Cook v. Tullis*, 85 U. S. 332, 21 L. Ed. 933.

Upon the other hand, the plaintiff earnestly insists that, under the Act of 1898, prior to amendment, a transfer of property, or a payment of money by the debtor to a creditor on account of an antecedent debt, was a preference, although the creditor was ignorant of the insolvency of the debtor and had no reasonable cause to believe that a preference was intended; and in support of this view the decision of the Supreme Court of the United States, in *Pirie v. Chicago Title & Trust Company*, 182 U. S. 438, 21 Sup. Ct. 906, 45 L. Ed. 1171, is cited. In that case Frank Bros., the bankrupts, had, within four months, and while they were insolvent, paid to Carson, Pirie, Scott & Co. money on account. The creditor was not aware of the insolvency of the bankrupts, and had no reason to believe that a preference was intended. At the time the bankruptcy proceedings were instituted there was still due the creditor a balance, and it presented its claim therefor against the bankrupt estate, and the issue was whether, under such circumstances, the creditor must surrender the preference before its claim could be allowed. Subdivision "g" of section 57 of the bankruptcy act provides that:

"The claims of creditors who have received preferences shall not be allowed unless such creditors have surrendered their preferences."

Assuming that in the Pirie Case the creditor had received a preference, it is obvious that its claim against the estate for the balance due to it could not be allowed without prior surrender of such preference. But here neither the bank nor any one in privity with it, is presenting a claim against the estate, and hence the provisions of the statute just quoted are not applicable. Subdivision "b" of section 60 is as follows:

"If a bankrupt shall have given a preference within four months before the filing of a petition, or after the filing of a petition and before the adjudication, and the person receiving it or to be benefited thereby, or his agent acting therein, shall have had reasonable cause to believe that it was intended thereby to give a preference, it shall be voidable by the trustee, and he may recover the property, or its value, from such person."

Here is found plaintiff's authority for bringing a suit to avoid a preference, and here, too, are prescribed the conditions upon which he may recover; and, as was said by the Supreme Court in the Pirie Case, *supra*:

"If the conditions mentioned exist, the preference may be avoided; but if the person receiving the preference did not have cause to believe it was intended, what then? It follows that, the condition being absent, its effect will be absent. In other words, he may keep the property transferred to him, whether it be a complete or partial discharge of his debt. * * * Unless surrendered, he who received it cannot prove his debt or other debts. His election is between keeping the preference and surrendering it. That is the favor of the law to his innocence, but, aiming to secure equality between him and other creditors, can the law indulge farther? He may have been paid something—maybe a greater percentage than other creditors can be. That is his advantage and he may keep it."

Upon his own theory, therefore, before plaintiff can succeed in avoiding the alleged preference, the existence of four conditions must be made to appear: First, that the lumber company was insolvent when the assignment was made; second, that the assignment was made upon account of an antecedent indebtedness; third, that the bank had reasonable cause to believe that, by the assignment, it was intended to give a preference; and, fourth, that the effect of the assignment was to enable the bank to obtain a greater percentage of its debt than other creditors of the same class.

If, following the assumption that the plaintiff may recover in an action at law, it should be held that the plaintiff need not plead the existence of these conditions, but may make proof thereof in response to the defendant's allegations and proof of the assignment, it cannot be doubted that upon him rested the burden of proof. There is much to be said for the view advanced by the defendant, that while the assignment was not formally made until the 24th day of January, 1900, it should be deemed to relate back to the 9th day of January, at which time the lumber company agreed to turn the voucher over to the bank. In other words, upon the 9th day of January there was an agreement to give security, and, relying upon this agreement, the bank made advances which it would not otherwise have made. Such a question was decided by the Circuit Court of Appeals of the Fourth

Circuit, in *Tomlinson v. Bank of Lexington*, 145 Fed. 824, 76 C. C. A. 400, and it was there held that, where a bank allowed a customer to overdraw on the express agreement that good accounts should be assigned to the bank for collection to pay the overdraft, the subsequent actual assignment of these accounts did not constitute the giving of a preference, although at the time of the assignment the customer was insolvent. The court says:

"If such assistance on the part of banking institutions is to be condemned, held to be preferences in case of bankruptcy, many of the manufacturing and other institutions would suffer, especially in their early days of struggle, before they had obtained a standing on a foundation strong enough to enable them to resist the financial storm arising from an inability to sell their product or realize on accounts, bills of lading, or other current assets. In short, it would close to them all the avenues of commerce, and compel them to do a C. O. D. business on a very small scale, virtually putting them out of business as soon as it is proved they cannot meet their liabilities, are insolvent, as defined in the bankrupt act. Congress did not intend, nor did it in fact ever enact, a law to effect this purpose."

Again, the court says:

"The objection that no specific accounts were mentioned in the agreement is without force. Those accounts may not have been in the shape of bills collectible at that time, nor due or negotiable *in fieri*."

And again:

"It is not necessary to hold that the agreement was a valid lien under any lien law, but it is an equitable pledge of 'good accounts' on the faith of which the bank parted with funds—possibly not its own, but on deposit—which it might rightfully use in banking and discounting commercial paper, as is customary with such institutions."

See, also, *Jaquith v. Alden*, 189 U. S. 78, 23 Sup. Ct. 649, 47 L. Ed. 717; *Bank v. Massey*, 192 U. S. 138, 24 Sup. Ct. 199, 48 L. Ed. 380; *West v. Bank*, 16 Okl. 328, 85 Pac. 469.

It must be admitted that the rule in the *Tomlinson Case*, if adopted here, would be controlling, for, upon the 9th day of January, when the agreement for the assignment was made, there was nothing due from the lumber company to the bank, and in no view of the law or the disputed facts could an assignment upon that day, in the absence of positive fraud, be deemed a preference.

But, considering the assignment as not having been made prior to the date upon which the written order was formally executed and delivered to the bank—that is, upon January 24th—what are the rights of the parties? Upon January 24th the lumber company owed the bank \$851.50. There was, therefore, an antecedent indebtedness, to pay which, or to secure which, the assignment was made, and to that extent, at least, the existence of one of the necessary conditions, appears. Are the other three conditions proven?

There is no direct proof of the financial condition of the lumber company upon January 24th, or, indeed, at any other time. It does appear that about that time it was unable to pay its debts in the ordinary course of business, and this would have been sufficient under the law of 1867 to establish insolvency; but under the act of 1898, as we have seen, it must be shown that the aggregate of the property

of the lumber company, at a fair valuation, was insufficient to pay its debts. My attention has not been called to any feature of the record, either in the stipulation of facts, or the exhibits, or the testimony, or the pleadings, which enables me to find or infer what property the lumber company owned, or what was its reasonable value, on the 24th day of January, 1900, or upon any other date; upon this point the record is absolutely silent. Evidence of the indebtedness of the company is not altogether satisfactory, but possibly sufficient to enable the court to make some intelligent estimate thereof. In the argument counsel for the plaintiff repeatedly refers to the fact that the lumber company was arranging for overdrafts, and was urging the railroad company to hasten payment of invoices, and it is insisted that therefore the lumber company must have been insolvent, and that the bank was aware of such insolvency. But the conclusion does not follow; the aggregate of the property of a debtor, taken at a fair valuation, may be far in excess of the amount of his debts, and still he may not have the current funds with which to meet his indebtedness as it falls due. Here the lumber company may have been doing business upon a large scale with a limited capital, and necessarily some time must elapse before it could realize upon the finished product of the work in which it was engaged. It must incur indebtedness for supplies and for labor, which ultimately could be paid for out of the proceeds of the contract, but which in the meantime must be taken care of with other funds. That it should be arranging for overdrafts, and promising to turn into the bank vouchers and drafts and checks, was not extraordinary, and in itself its conduct in that respect is insufficient to create even a suspicion of insolvency, as the term is used in the bankruptcy law. Suppose the owner of a thousand head of cattle came to a bank, with the statement that the cattle were ready for market, and he desired to ship them, but that he had no current funds, and he applied to the bank for advances with which to meet the expense of gathering the cattle and loading them and paying the freight charges and other expenses of taking them to the market, with the agreement that in consideration of such advances the bill of lading should be assigned to the bank, would such facts be sufficient from which the court could legitimately draw an inference that the owner of the cattle was insolvent or that the bank had reasonable cause to believe him insolvent? Nor would the case be essentially different if the stockman was already indebted to the bank in a reasonable amount upon overdrafts allowed for paying the expenses of wintering the cattle.

In principle the illustration cannot be distinguished from the facts in this case, and similar transactions are of daily occurrence. The language above quoted from the Tomlinson Case clearly portrays the results of a ruling such as is here contended for by the plaintiff. To hold that the bank knew or had reason to believe that the lumber company was insolvent on the 9th day of January, or that it was financially embarrassed, is little less than preposterous. The bank proceeded to make advances, and permitted overdrafts to the amount of approximately \$850, without any security other than the bare oral

promise of the officers of the lumber company to the effect that its receipts, including the voucher for the ties, would in the future be turned over to the bank. This promise might or might not be fulfilled, and it is not credible that a banker would, if he thought the lumber company insolvent or embarrassed, or likely to be embarrassed, have advanced any amount at all. The lumber company had not theretofore been a customer of the bank, and hence no consideration of past or existing relations could have weighed with the bank to induce it to extend credit to a needy customer, with the hope that, temporarily relieved, he would be able to recover himself. So far as is disclosed by the record, nothing took place between the 9th of January and the 24th of January, either affecting the actual responsibility of the lumber company or tending to cast suspicion upon its solvency. That its unpaid bills were increasing was not strange, for it was engaged in a large enterprise, in the prosecution of which it was daily employing labor and incurring other expenses, but from which, during this period, it was receiving no money returns. It was doubtless known to the bank that the lumber company was making a comparatively large delivery of ties, and that until it could be paid for such delivery it had no means for meeting its accruing daily expenses. Assuming—and there is nothing to the contrary—that the contract with the railroad company was a profitable one, the bank had the right to proceed upon the theory that payment on account of the deliveries from time to time would enable the lumber company to meet all of its accruing obligations, and, if it confided in the honesty of the officers of the lumber company, there was nothing suspicious or unusual in its willingness to permit the account to be overdrawn. Nor is it strange that, when the January delivery of ties had been accepted by the railroad company, the bank, before increasing its advances, desired assurance both from the railroad company and the lumber company of the amount which was due on account of such delivery, and that it would be paid directly to the bank as soon as it was practicable for the railroad company to do so in the ordinary course of business.

While in the absence of a showing as to the real financial condition of the lumber company much is left to conjecture, I am persuaded that its downfall was precipitated by the seizure of the ties by the government; for apparently these were its only visible assets, upon which it could rely for current funds. Unless it had a substantial capital or a very large credit, the natural and the inevitable result of such a claim upon the part of the government would be to deprive it of all future credit, and to arouse its existing creditors to demand immediate payment. It appears that while the government soon released the ties for which the \$3,302.52 was due, it seized other ties which the lumber company had cut and which were still in the woods. What number of ties was so seized is not disclosed, but all the expense which had been incurred in getting them out was thus lost; and, in addition thereto, there were the claims of the government for trespass, amounting to nearly \$5,000, for which suit was brought. Thus, in a few days, and from causes not theretofore known or appreciated by any of the parties, the financial status of the lumber company underwent a radical

change, and its credit received a fatal shock. The consternation of creditors upon learning of the claims of the government may well be imagined, and it is not improbable that the action of the bank in canceling the note which it took from the lumber company on the 3d of February, and charging the proceeds thereof back to the lumber company upon the day after the note was executed, is thus accounted for. That it had reason for alarm must be admitted, for, if the government insisted upon its claim that the January delivery of ties had been wrongfully cut upon public lands, the railroad company might not pay anything on account thereof, and the bank would thus be left without security or resources from which the lumber company's overdraft could be taken care of. Nor, under the circumstances, is it strange that the bank did not credit up to the account of the lumber company the \$3,302.52. It had not received the money from the railroad company, and, in view of the attitude of the government, there was doubt whether it ever would receive payment. But in any view the failure to give credit in the books of the company is not a controlling consideration. The bank was the assignee of the claim, and whether the assignment was with the understanding that the lumber company should receive credit for the full amount thereof at once, without waiting for the collection, or whether the understanding was that the collection, when made, should be credited to the account of the lumber company, the assignment was made for the protection of the bank against the overdraft account, and the bank thus acquired an irrevocable interest in the claim.

Not only is there no proof of the aggregate of the lumber company's property at a fair valuation upon the date of the assignment, but the record is also silent as to the value of the bankrupt's assets at any time after the bankruptcy proceedings were instituted. That being the case, upon what basis can the court make a finding that the effect of the assignment was to enable the bank to obtain a greater percentage of its debt than other creditors of the same class? It is conceded by counsel that there is no positive or direct evidence as to the value of the bankrupt estate, but it is suggested that the record in the bankruptcy proceeding is in this court, and of that this court must take judicial knowledge. Assuming, but not deciding, that the record in the bankruptcy proceeding would be competent evidence against the defendant in this case, that record is not before this court. This action is not ancillary to the bankruptcy proceeding, but is entirely independent thereof, and there is no rule requiring or authorizing the court to take knowledge of the existence or contents of all papers filed in the office of its clerk. Moreover, the bankruptcy proceedings were not had in this court, but in the District Court.

Without prolonging the discussion, I think it must be held that plaintiff's proof wholly fails to show that the lumber company was insolvent when the assignment was made, or that the bank had reasonable cause to believe that by the assignment it was intended to give a preference, or that the effect of the assignment was to enable the bank to obtain a greater percentage of its debt than other creditors of the same class.

There remains to be considered a contention of the defendant some-

what independent of its position that the assignment was a voidable preference, and that is, that the 11,305 ties were not delivered to the railroad company in January, 1900, but were thereafter delivered by the trustee in bankruptcy. Touching this point, the facts are stipulated to be as follows: That on or about the 19th day of January, 1900, the lumber company delivered, along the spur track of the railroad company at North Fork, in Shoshone county, the 11,305 ties; that thereupon an inspector representing the railroad company, in the presence of the secretary of the lumber company, who pointed out the ties to the inspector, examined the ties and approved them, and marked them with the railroad company's paint, and after so inspecting and marking the ties the inspector issued to the railroad company's various officials and to the lumber company an invoice of the ties "and received said ties." And thereupon the inspector went with the secretary of the lumber company to the offices of the resident engineer of the railroad company at Potlatch, in Nez Perce county, where the engineer was informed that the ties had been delivered and accepted. After the railroad company had hauled a portion of the ties from the place where they were piled along its spur track, the balance were attached by a creditor of the lumber company and were taken into the possession of the sheriff of Shoshone county by virtue of a writ of attachment, but the same were not removed from the place where they were piled. On October 1, 1900, the trustee in bankruptcy of the lumber company filed a petition before the referee in bankruptcy setting forth the facts relative to the delivery of the ties to the railroad company and the seizure thereof by the government, and its subsequent release thereof, and the subsequent attachment by the sheriff of Shoshone county, and the bankruptcy of the lumber company, and prayed for an order permitting him, the trustee, to allow the railroad company "to receive and take away the said ties." Thereupon, after notice to all parties in interest, the referee made an order that the trustee "permit the said Clearwater Short Line Railway Company to receive and take away said ties, and that said B. F. Morris (the then trustee) should no longer be bound as such trustee to retain said ties or to account for the same." The order further provided that nothing therein contained "should in any way interfere with or affect any right, if any, which the creditors of said Clearwater Land, Log & Lumber Company, or the trustee in bankruptcy thereof, might have to recover of said Clearwater Short Line Railway Company the purchase price of said ties under said contract between the said railway company and said Clearwater Land, Log & Lumber Company." Defendant insists that the delivery to it was consummated in January, and in this contention I think it is clearly right; it is difficult to conceive of a more complete delivery. The ties had been hauled by the lumber company from the place where they were cut, and, for the purpose of turning them over to the railroad company, had been piled upon its right of way. They were inspected, counted, and accepted by the railroad company, and its brand was placed thereon. Thereupon the inspector certified to the lumber company and to the officers of the railroad company the receipt of the ties. What else remained to be done or could have been done to com-

plete the delivery? The mere fact that payment in cash for the ties was not made upon the spot is immaterial. There was no provision in the contract that title should not pass or that delivery should not be considered to have been made until the purchase price was paid.

The delivery to the railroad company having been made before the bankruptcy proceedings were instituted, the trustee in bankruptcy could not rightfully control or take possession thereof, nor is there any showing that he ever did take actual possession. Being in doubt as to his duty and responsibility in the premises, it was proper, before giving his consent that the railroad company should remove the ties, that he be authorized by the court to give such permission. And the fact that the railroad company did not take the ties until such order was made is without significance. In view of the attachment and the bankruptcy proceedings, some question may have been raised as to the rights of the parties, but, under the facts as here stipulated, there is no room for doubt. There was no authority in law for either the sheriff of Shoshone county or the trustee in bankruptcy to interfere with the railroad company's possession of the ties; with their delivery, title passed. There is nothing either in the petition to the referee or the order made by him material to the issues here. It was clearly the intention of the referee, and it is expressly provided, that the rights of the parties, whatever they may have been, were not to be affected by the order. The position of the trustee in this action is neither strengthened nor weakened by those proceedings.

My conclusion upon this phase of the case is that plaintiff is not entitled to recover any part of the \$3,302.52. True, the amount exceeds the aggregate of the overdraft account by \$43.27, and there are some items of charge against the lumber company upon the books of the bank the validity of which may well be doubted. But the equities between the bank and the lumber company cannot be adjusted in this action. Moreover, it is not clear that the conclusion which I have reached upon the whole case does not coincidentally approximate the result of an equitable accounting between the defendant, the bank and the lumber company.

It is admitted that the plaintiff is entitled to recover the \$378 item, subject, however, to a reduction in the amount of the defendant's valid counterclaims. By its contract, the lumber company guaranteed that it would convey a good and unincumbered title to the ties which it was to deliver to the railroad company; and it was further agreed that "in case of legal proceedings against the company for any of said ties or their values, or to establish any lien or claim thereon, or thereto, said second party (the lumber company) will indemnify and hold harmless the company (railroad company) from all loss, damages, costs, and expenses thereby incurred." It is stipulated that some of the ties delivered were wrongfully cut upon the public land of the United States, and that the United States brought suit against the railroad company and the lumber company for trespass, and that the claim of the government was settled by the payment by the railroad company of \$244.96. Under the contract, this was a proper set-off against the demand of the lumber company. But it is expressly alleged by the

defendant and stipulated that, in paying to the Exchange National Bank the amount due on account of the January delivery, the \$244.96 was deducted from the \$3,302.52. Defendant's claim upon this account has, therefore, been fully satisfied, and cannot be again used as a set-off.

It is further stipulated that the demand of the United States for trespass amounted to \$4,929.24, and that, in defending against it, the railroad company necessarily expended the sum of \$124.54. It is not clear why this item was not, like the \$244.96, deducted from the \$3,302.52, if the railroad company considered it a proper and just set-off; but under the stipulated facts, no good reason is perceived why the charge is not covered by the lumber company's obligation of indemnity, or why the railroad company is not now entitled to be reimbursed therefor. The amount was paid out as costs and expenses in legal proceedings against the railroad company to recover the value of those ties which had been wrongfully cut upon public lands.

The third item of the counterclaim is \$126, representing expenses incurred by the railroad company in sending a train to the place where the ties were delivered upon its right of way. As we have already seen, complete and absolute delivery of the ties was made by the lumber company to the railroad company in January. The lumber company was not thereafter in any wise responsible for the ties, and exercised no control over them. Notwithstanding such delivery, a creditor of the lumber company brought suit in attachment against it, and the sheriff of Shoshone county, in executing the writ, seized the ties as its property. The railroad company, acting upon information which it claims to have procured from the attorneys for the plaintiff in the attachment suit to the effect that the attachment had been released, sent a train to the place where the ties were piled, and attempted to load and haul them away, but while it was engaged in so doing the sheriff informed it that the attachment was not released, and warned against removal of the ties. The \$126 item represents the expense of this trip. Upon what theory of law can the item be considered a just charge against the lumber company? There is no pretension that it, or any of its officers, or agents, or attorneys misled or deceived the railroad company, or, directly or indirectly, caused it to make the fruitless trip. Moreover, the lumber company had no responsibility in the premises. When it delivered to the railroad company ties in accordance with the specifications of the contract, and they were accepted by the railroad company, if at the time of their delivery and acceptance the lumber company's title thereto was good and the ties were free from all encumbrances and liens, its guaranty was fulfilled. It did not instigate the seizure of the ties, and was in no wise responsible therefor. The attaching creditor had no more right in law to make the seizure than he did to attach one of the defendant's engines or cars. If the sheriff of Shoshone county violated the defendant's rights by attaching its property in a suit against a third person, the defendant had its remedy against the sheriff.

The fourth, and last, item of the counterclaim is \$172.29, representing the increased cost of ties purchased by the railroad company. The

contract provided that, in case the second party should fail to deliver to the railroad company any portion of the ties contracted for within the time therein provided, the railroad company should have the right to purchase from other parties a sufficient number to make up the deficiency, and should be entitled to charge the lumber company the cost of such ties in excess of the prices which the lumber company was to receive under the contract. It is stipulated that the lumber company delivered 31,331 ties, all before the 1st of February, 1900; that of said 31,331 so delivered the railroad company was deprived of some of the ties seized by the sheriff in said attachment suit from about the middle of February, 1900, to the middle of October, of the same year. It is further stipulated "that by reason of the failure of the said Clearwater Land, Log & Lumber Company to furnish said Clearwater Short Line Railway Company with ties in excess of 31,331 ties, and by reason of the inability of said railway company to secure possession of said 11,305 of the said 31,331 ties from the time of said attachment until between the first and the middle of October, 1900, it became necessary for said railway company to secure ties otherwise and elsewhere to be used in the construction of its line of railway as aforesaid, and said railway company did secure ties otherwise and elsewhere, and used the same in said construction; that the amount so secured otherwise and elsewhere was 11,188, and the same were secured in the month of March, 1900; that the said 11,188 ties so secured otherwise and elsewhere by said railway company cost said company \$172.89 more than the contract price of said 11,188 would have been under said contract with the said Clearwater Land, Log & Lumber Company." It will be noted that under the stipulation of facts, and upon the record, it is impossible to determine what part of the \$172.89 is claimed to have been the result of the attachment, and what part the result of the failure of the lumber company to deliver the full number of 300,000 ties. What has already been said relative to the item of \$126 is applicable to so much of the item as represents damages flowing from the wrongful attachment; the lumber company is not chargeable therewith. If, in being deprived of the possession and use of the ties by the wrongful attachment, the railroad company suffered damages, it should have proceeded against the sheriff. The facts stipulated are not sufficient to enable the court to make a finding as to what damage, if any, the railroad company suffered by reason of the default of the lumber company to furnish the full number of 300,000 ties. Four months before the time for completing the contract had elapsed, the railroad company purchased ties at a price in excess of the contract price; no authority for so doing was conferred by the contract, and, upon the showing, no credit can be allowed to defendant on account of this item.

It is concluded that there should be credited upon the \$378 due from the defendant to the lumber company the \$124.54 expended by the railroad company in defending the trespass suits, and that the plaintiff should have judgment for the balance of \$253.46, and interest thereon at the rate of 7 per cent. per annum from January 1, 1900, to the date of the entry of judgment.

A. H. RINGK & CO. v. UNITED STATES.

(Circuit Court, S. D. New York. May 22, 1908.)

No. 5,077.

CUSTOMS DUTIES (§ 36*)—CLASSIFICATION—FEATHERED POST CARDS—"PRINTED MATTER."

Imported post cards bore on the face words printed in different languages and on the back printed pictorial representations, and were ornamented with feathers; the feathers being the element of chief value. *Held*, that the printing, and not the feathers, constituted the chief feature of the cards, and that therefore the cards were "printed matter," within the meaning of Tariff Act July 24, 1897, c. 11, § 1, Schedule M, par. 403, 30 Stat. 189 (U. S. Comp. St. 1901, p. 1673).

[Ed. Note.—For other cases, see Customs Duties, Dec. Dig. § 36.*

For other definitions, see Words and Phrases, vol. 6, pp. 5563-5564; vol. 8, p. 7763.]

On Application for Review of a Decision by the Board of United States General Appraisers.

In the decision below the Board of General Appraisers affirmed the assessment of duty by the collector of customs at the port of New York. Following is an extract from the Board's opinion:

FISCHER, General Appraiser. These protests are in regard to the classification of pictorial post cards ornamented with feathers. * * * On one side of such cards the inscription "post card" is printed. This is the only printed matter on the address side, and it appears repeated in various languages. On the reverse side appear pictures of birds, which have been printed by process other than lithographic and are colored. The coloring has been done by stenciling with water color. The printed and coloring matter act merely as a background to display the birds, which appear in their plumage, represented by ornamental feathers, dyed and colored, and pasted and affixed upon such pictures. We are of the opinion that the claim as printed matter cannot be maintained. The feathers being of greatest value, and the printed matter insignificant and subordinate in character, such printed matter would not govern the classification any more than the coloring matter would govern it as paintings.

Everit Brown, for importers.

J. Osgood Nichols, Asst. U. S. Atty.

PLATT, District Judge (orally). The merchandise in controversy consists of post cards. Upon the face of the cards appear certain words, printed in different languages, and upon the reverse side appear certain pictorial representations produced by printing, and in addition an ornamentation of feathers. They were classified for duty as feathers manufactured, under paragraph 425, Schedule N, § 1, c. 11, Tariff Act July 24, 1897, 30 Stat. 191 (U. S. Comp. St. 1901, p. 1675). The importer set forth various claims in his protest, which upon the argument were limited to the provision contained in paragraph 403, Schedule M, of the act (30 Stat. 189 [U. S. Comp. St. 1901, p. 1673]), for "printed matter."

If the post cards were imported minus the ornamental feathers, they would without doubt be classifiable as printed matter under paragraph

*For other cases see same topic & § NUMBER in Dec. & Am. Digs. 1907 to date, & Rep'r Indexes

403. The only choice in that case would be between printed matter and the catch-all clause of paragraph 407 (30 Stat. 189 [U. S. Comp. St. 1901, p. 1673]), for manufactures of paper not otherwise provided for. The printing upon the cards is not insignificant and subordinate in character. It is the chief thing, without which, even with the ornamentation, the merchandise would be of no practical value. The ornamentation, rather than the printed matter, appears to be the incidental feature of the article.

If an attempt should be made hereafter to introduce valuable merchandise under the guise of "printed matter," the reversal of the Board herein ought not to be considered as a precedent. I think the merchandise as imported ought to be classified as "printed matter," under said paragraph 403.

The decision of the Board of Appraisers is therefore reversed.

MEMORANDUM DECISIONS.

CORSER v. SWEET et al. (Circuit Court of Appeals, Second Circuit. November 16, 1908.) No. 42. Appeal from the Circuit Court of the United States for the Southern District of New York. For opinion below, see 157 Fed. 759. W. A. Macleod and Clarke C. Fetts, for appellant. Chas. S. Jones, for appellees. Before LACOMBE, COXE, and WARD, Circuit Judges.

PER CURIAM. Decree of Circuit Court affirmed, with costs.

FULTON BAG & COTTON MILLS v. HUDSON NAVIGATION CO. (Circuit Court of Appeals, Second Circuit. November 16, 1908.) No. 31. Appeal from the District Court of the United States for the Southern District of New York. For opinion below, see 157 Fed. 987. Edward B. Shattuck (Garrard Glenn, of counsel), for appellant. Robinson, Biddle & Benedict (Roderick Terry and W. S. Montgomery, of counsel), for appellee. Before LACOMBE, COXE, and NOYES, Circuit Judges.

PER CURIAM. Decree affirmed, with costs, upon opinion of District Judge.

In re HAASE (two cases). (Circuit Court of Appeals, Second Circuit. October 27, 1908.) Nos. 12, 70. Petition to Review Order of, and Appeal from, the District Court of the United States for the Southern District of New York. For opinion below, see 155 Fed. 553. Stern, Singer & Barr, for petitioners. Edward Fillmore, for respondent. Before LACOMBE, COXE, and NOYES, Circuit Judges.

PER CURIAM. Affirmed in open court.

LOUISVILLE & N. R. CO. v. PHILLIPS.* (Circuit Court of Appeals, Fifth Circuit. November 10, 1908.) No. 1793. In Error to the Circuit

*Rehearing denied January 12, 1909.

Court of the United States for the Northern District of Alabama. Before PARDEE and SHELBY, Circuit Judges, and BURNS, District Judge.

PER CURIAM. A majority of the Judges are of opinion that the record in this case shows no reversible error and the judgment of the Circuit Court should be affirmed. It is so ordered. See, also, 153 Fed. 795.

MORSE v. UNITED STATES. (Circuit Court of Appeals, Second Circuit. November 10, 1908.) In Error to the Circuit Court of the United States for the Southern District of New York. Wallace Macfarlane, for the motion. Henry L. Stimson, U. S. Atty.; opposed. Before LACOMBE, COXE, and WARD, Circuit Judges.

PER CURIAM. The trial judge having heard the application to admit to bail and denied it, we are not prepared on the papers now before us to make any different disposition of the same. The motion is denied, without prejudice to its renewal after bill of exceptions is filed. See 161 Fed. 429.

NOOJIN v. UNITED STATES.† (Circuit Court of Appeals, Fifth Circuit. November 10, 1908.) No. 1,777. In Error to the Circuit Court of the United States for the Northern District of Alabama. Before PARDEE and SHELBY, Circuit Judges, and BURNS, District Judge.

PER CURIAM. We find none of the assignments of error well taken. The judgment of the District Court is affirmed. See, also, 155 Fed. 377.

SMITH et al. v. PRATT CONSOLIDATED COAL CO. et al. (Circuit Court of Appeals, Fifth Circuit. November 10, 1908.) No. 1,844. Appeal from the District Court of the United States for the Northern District of Alabama. Before PARDEE and SHELBY, Circuit Judges, and BURNS, District Judge.

PER CURIAM. The question involved in this case is whether sufficient compensation has been allowed lawyers who successfully conducted a litigation which brought into the hands of the trustee in bankruptcy a large sum of money for distribution among creditors. The referee heard evidence and allowed \$6,000. On review the District Judge, on the same and more evidence, reduced the allowance to \$3,600. Under the evidence in the transcript, we are not prepared to say that either allowance was so far erroneous as to warrant a reversal. The decree of the District Court is affirmed.

NUNGESSER ELECTRIC BATTERY CO. v. NATIONAL CARBON CO. (Circuit Court of Appeals, Sixth Circuit. May 29, 1908.) No. 1,768. Appeal from the Circuit Court of the United States for the Northern District of Ohio. Charles B. Miller, for appellant. E. L. Thurston, for appellee. Before LURTON, SEVERENS, and RICHARDS, Circuit Judges.

RICHARDS, Circuit Judge. This is a suit which involves the alleged infringement of patent No. 641,546 for a battery filler. The defendant, who held patent No. 809,526, for a machine for filling dry batteries attacked the validity of the patent and denied any infringement. The court below (159 Fed. 57) reached the conclusion that the complainant's patent was not anticipated and was valid, and, after a careful opinion, in which the details of the two patents were compared, held there was infringement. It is unnecessary to recount the reasons given by the lower court. We content ourselves with affirming its decree on the authority of its opinion, which appears in the record.

† Rehearing denied January 12, 1909.

UNITED STATES v. AMERICAN TOBACCO CO. et al.

(Circuit Court, S. D. New York. December 15, 1908.)

The following is the substance of the final decree in the above-entitled case (164 Fed. 700).

"Second. That the defendants, other than those against whom the petition is dismissed, have heretofore entered into and are now parties to combinations in restraint of trade and commerce among the several states and with foreign nations in leaf tobacco, products manufactured therefrom, and articles necessary or useful in connection therewith, in violation of the act of Congress approved July 2, 1890, entitled "An act to protect trade and commerce against unlawful restraints and monopolies" (Act July 2, 1890, c. 647, 26 Stat. 209 [U. S. Comp. St. 1901, p. 3200]). Wherefore, said defendants and each of them, their officers, agents, directors, servants, and employes, are hereby restrained and enjoined from directly or indirectly doing any act or thing whatsoever in furtherance of the objects and purposes of said combinations and from continuing as parties thereto.

"Third. That each of the defendants, the American Tobacco Company, American Snuff Company, American Cigar Company, American Stogie Company, and MacAndrews & Forbes Company, constitutes and is itself a combination in violation of the said act of Congress. Wherefore, defendants the American Tobacco Company, American Snuff Company, American Cigar Company, American Stogie Company, and MacAndrews & Forbes Company, together with the officers, directors, agents, and employes of each of them, are each and all hereby restrained and enjoined from further directly or indirectly engaging in interstate or foreign trade and commerce in leaf tobacco, or the products manufactured therefrom, or articles necessary or useful in connection therewith; but, if any of said last-named defendants can hereafter affirmatively show the restoration of reasonably competitive conditions, such defendant may apply to this court for a modification, suspension, or dissolution of the injunction herein granted against it.

"Fourth. The American Tobacco Company has acquired and now holds and claims to own some or all of the capital stock of the following corporations, defendants herein: F. F. Adams Tobacco Company, etc. The American Tobacco Company also claims to own a majority of the capital stock of the defendant corporation R. P. Richardson, Jr., & Co., Incorporated. The American Snuff Company has acquired and now holds and claims to own some or all of the capital stock of the following corporations named as defendants herein: American Cigar Company,' etc. The American Cigar Company has acquired and now holds and claims to own some or all of the capital stock of the following corporations named as defendants herein: Amsterdam Supply Company,' etc. P. Lorillard Company has acquired and now holds and claims to own some or all of the capital stock of the following corporations, defendants herein: American Snuff Company and Amsterdam Supply Company. R. J. Reynolds Tobacco Company has acquired and now holds and claims to own some or all of the capital stock of the following corporations, defendants herein: Amsterdam Supply Company, Lilpfert-Scales Company, and MacAndrews & Forbes Company. Blackwell's Durham Tobacco Company has acquired and now holds and claims to own some or all of the capital stock of the following corporations, defendants herein: Amsterdam Supply Company, F. R. Penn Tobacco Company, Scotten-Dillon Company, and Wells-Whitehead Tobacco Company. Conley Foil Company has acquired and now holds and claims to own some or all of the capital stock of the defendant Johnston Tin Foil & Metal Company. Wherefore each and all of defendants, the American Tobacco Company, the American Snuff Company, the American Cigar Company, P. Lorillard Company, R. J. Reynolds Tobacco Company, Blackwell's Durham Tobacco Company, and Conley Foil Company, their officers, directors, agents, servants, and employes, are hereby restrained and enjoined from acquiring, by conveyance or otherwise, the plant or business of any such corporation wherein any one of them now holds or owns stock; and each and all of said defendant corporations so holding stock in other corporations as above speci-

fied, their officers, directors, agents, servants, and employés, are further enjoined from voting or attempting to vote said stock at any meeting of the stockholders of the corporation issuing the same, and from exercising or attempting to exercise any control, direction, supervision, or influence whatsoever over the acts and doings of such corporation. And it is further ordered and decreed that each and every of the defendant corporations the stock of which is held by any other defendant corporation as hereinbefore shown, their officers, directors, servants, and agents, be and they are hereby respectively and collectively restrained and enjoined from permitting the stock so held to be voted by any other defendant holding or claiming to own the same, or by its attorneys or agents, at any corporate election for directors or officers, and from permitting or suffering any other defendant corporation claiming to own or hold stock therein, or its officers or agents, to exercise any control whatsoever over its corporate acts."

164 F.—65

END OF CASES IN VOL. 164.

*

INDEX.

ABANDONMENT.

Of patent, see Patents, § 2.
Of water rights, see Waters and Water Courses, § 2.

ABATEMENT AND REVIVAL.

Civil or criminal nature of motion by executrix to abate judgment entered against decedent in criminal action as affecting appellate jurisdiction of Circuit Court of Appeals, see Courts, § 2.
Judgment as bar to another action, see Judgment, § 4.

ACCEPTANCE.

Of offer to sell, see Sales, § 1.

ACCIDENT.

Cause of death, see Death, § 1.

ACCOUNT.

Accounting between partners, see Partnership, § 1.

ACTION.

Bar by former adjudication, see Judgment, § 4.
Civil or criminal nature of motion by executrix to abate judgment entered against decedent in criminal action as affecting appellate jurisdiction of Circuit Court of Appeals, see Courts, § 2.
Commencement within period of limitation, see Limitation of Actions, § 2.
Concealment of cause of action, see Limitation of Actions, § 2.
Jurisdiction of courts, see Courts.
Laches, see Equity, § 1.
Limitation by statute, see Limitation of Actions.
Set-off, see Set-Off and Counterclaim.
Actions between parties in particular relations.
See Partnership, § 1.
Actions by or against particular classes of persons.
See Carriers, §§ 3, 4; Clerks of Courts; Master and Servant, § 2; Receivers, § 1.
Trustee in bankruptcy, see Bankruptcy, § 6.

Particular causes or grounds of action.

See Negligence, § 2.
Alienation of affections, see Husband and Wife, § 1.
Breach of contract, see Contracts, § 4; Sales, § 3.
Breach of warranty, see Sales, § 4.
Death caused by operation of railroad, see Railroads, § 2.
Death of passenger, see Carriers, § 4.
Infringement of copyright, see Copyrights, § 2.
Infringement of patent, see Patents, § 6.
Infringement of trade-mark or trade-name, see Trade-Marks and Trade-Names, § 2.
Loss of or injury to tow, see Towage.
Personal injuries, see Carriers, § 4; Railroads, § 2.
Royalties for sale of patented articles, see Patents, § 5.
Unfair competition in trade, see Trade-Marks and Trade-Names, § 2.

Particular forms of action.

See Trover and Conversion.

Particular forms of special relief.

See Injunction; Specific Performance.
Cancellation of written instrument, see Cancellation of Instruments.
Dissolution of corporation, see Corporations, § 2.
Dissolution of partnership, see Partnership, § 1.
Enforcement or foreclosure of lien, see Railroads, § 1.
Foreclosure of mortgage, see Railroads, § 1.
Quieting title to mining land, see Mines and Minerals, § 1.
Redemption from mortgage, see Mortgages, § 2.

Particular proceedings in actions.

See Damages; Evidence; Judgment; Jury; Limitation of Actions; Pleading; Process; Removal of Causes, § 1; Trial.
Notice of action, see Process, § 2.

Particular remedies in or incident to actions.

See Injunction; Receivers.
Counterclaim, see Set-Off and Counterclaim.

Proceedings in exercise of special or limited jurisdictions.

Criminal prosecutions, see Criminal Law.
Suits in admiralty, see Admiralty.

Review of proceedings.

See Appeal and Error.

*Point annotated. See syllabus.

ADJUDICATION.

Operation and effect of former adjudication, see Judgment, § 4.

ADMINISTRATION.

Of estate of bankrupt, see Bankruptcy, § 5.
Of estate of decedent, see Executors and Administrators.
Of estate of ward, see Guardian and Ward, § 1.

ADMIRALTY.

See Salvage; Seamen; Shipping; Towage.
Conflicting jurisdiction of courts of bankruptcy and admiralty, see Courts, § 3.

§ 1. Jurisdiction.

A contract between a marine insurance company and an insurance broker, by which the latter agreed to procure insurance for the company on marine risks on commission, and to be responsible for all premiums due on such insurance, is not a maritime contract; and an action thereon by the company to recover such premiums is not cognizable in a court of admiralty.—*St. Paul Fire & Marine Ins. Co. v. Birrell (D. C.)* 104.

ADMISSIONS.

By motion to dismiss equitable action for lack of proof, see Equity, § 4.

ADVERSE POSSESSION.

See Limitation of Actions.

§ 1. Nature and requisites.

§ 70. Color of title defined.—*United States v. Casterlin (C. C.)* 437.

§ 70. To constitute color of title, the title claimed must be founded on some written instrument, and a mere occupancy of public land by an Indian by permission of the government does not give him color of title thereto.—*United States v. Casterlin (C. C.)* 437.

ADVERTISEMENT.

Publication of process, see Process, § 2.

AFFIDAVITS.

Verification of pleading, see Pleading, § 2.

AGREEMENT.

See Contracts.

ALIENATION.

Of affections, see Husband and Wife, § 1.

ALIENS.

See Indians.

Removal of cause from state to federal court, see Removal of Causes, §§ 2, 3.

Review of proceedings as dependent on presentation of evidence in bill of exceptions, see Appeal and Error, § 3.

Right to sue for wrongful death, see Death, § 1.

§ 1. Exclusion or expulsion.

It is the settled general rule that the finding of a commissioner, who sees and hears Chinese witnesses sworn in behalf of Chinese persons of the prohibited class seeking entry to the United States, and who reaches the deliberate conclusion that they are not entitled to credit, will not be reversed by an appellate court.—*Hong Yon v. United States (C. C. A.)* 330; *Jin Dun v. United States, Id.*

Under Immigration Act Feb. 20, 1907, c. 1134, § 25, 34 Stat. 906 (U. S. Comp. St. Supp. 1907, p. 405), the decision of the appropriate immigration officers adverse to the admission of an alien is conclusive, unless reversed on appeal by the Secretary of Commerce and Labor, and cannot be reviewed by the courts on writ of habeas corpus.—*United States v. Watchorn (C. O.)* 152.

§ 38. An indictment charging the master of a vessel with having permitted an alien Chinese laborer to land in the United States from his vessel, in violation of Act Sept. 13, 1888, c. 1015, §§ 9, 10, 25 Stat. 478 (U. S. Comp. St. 1901, p. 1316), considered, and held sufficient.—*United States v. Graham (C. C.)* 654.

§ 23. The provisions of Immigration Act Feb. 20, 1907, c. 1134, 34 Stat. 898 (U. S. Comp. St. Supp. 1907, p. 391), excluding alien immigrants afflicted with certain diseases, etc., are applicable to Chinese immigrants otherwise entitled to admission.—*In re Lee Sher Wing (D. C.)* 506.

§ 2. Immigration.

Rule 4 of the regulations of the Bureau of Immigration construed.—*United States v. Watchorn (C. C.)* 152.

§ 3. Naturalization.

Under section 2165, Rev. St. (U. S. Comp. St. 1901, p. 1329), the declarations of intention of citizenship might be made by minors, provided that they had reached years of discretion.—*United States v. George (C. C. A.)* 45.

Naturalization Act June 29, 1906, c. 3592, § 4, subd. 4, 34 Stat. 596 (U. S. Comp. St. Supp. 1907, p. 422), requiring "continuous" residence of an applicant for five years in the United States and one year in the state, is not to be taken literally, but relates only to a change of domicile.—*In re Schneider (C. C.)* 335.

The knowledge of witnesses testifying to the continuous residence in a certain place of an applicant for naturalization need only be such as is compatible with his employment.—*In re Schneider (C. C.)* 335.

*An alien, who has no knowledge whatever of the existence of the Constitution, the organi-

*Point annotated. See syllabus.

zation of the government, or the manner of enacting or enforcing its laws, and who refuses to avail himself of time given him to acquire information on such subjects, is not entitled to admission as a citizen.—*In re Meakins* (D. C.) 334.

*An alien woman, married to an alien, although residing in this country and otherwise qualified, cannot become a citizen of the United States by naturalization.—*In re Rionda* (D. C.) 368.

ALTERATION OF INSTRUMENTS.

An alteration made in a note after it was signed by an indorser, but before its delivery, by or with the consent of the agent of such indorser, authorized to act for him in the transaction, does not release him from liability.—*Luckenbach v. McDonald* (C. C.) 296; *Same v. Kunzig*, *Id.*

AMENDMENT.

Of petition in bankruptcy, see *Bankruptcy*, § 1.

ANIMALS.

Carriage of live stock, see *Carriers*, § 3.

APEAL AND ERROR.

Appeal in criminal prosecution, see *Criminal Law*, § 5.

In bankruptcy proceedings, see *Bankruptcy*, § 9. In federal courts, see *Courts*, § 2.

§ 1. Decisions reviewable.

§ 80. A decree in equity which purports to settle finally and definitely the merits of the entire controversy between the parties is a final decree, from which an appeal lies, although the court retains jurisdiction in aid of its execution in accordance with the adjudicated rights of the parties.—*Harrison v. Clarke* (C. C. A.) 589.

§ 78. In the courts of the United States the refusal to quash an execution is not a final judgment, and cannot be reviewed on writ of error.—*Noojin v. United States* (C. C. A.) 692.

§ 78. An order striking a case from the docket is not reviewable by writ of error, it not being a final decision.—*Lofin v. Ayres* (C. C. A.) 841.

§ 2. Requisites and proceedings for transfer of cause.

§ 387. The failure to give a bond for costs at the time of taking an appeal is not ground for dismissing the appeal, provided the bond is filed within a reasonable time and the appellee is not prejudiced by the delay.—*Corcoran v. Kostrometinoff* (C. C. A.) 685.

§ 3. Record and proceedings not in record.

*Findings of a District Court adverse to the right of a Chinese person to remain in the United States, on his claim of citizenship, can-

not be reviewed on a writ of error, where the evidence was not made part of the record, by a bill of exceptions.—*Lew Moy v. United States* (C. C. A.) 322.

§ 4. Review.

Errors in a charge will be disregarded, if, upon all the evidence properly admitted, a verdict in favor of the successful party could not lawfully be sustained.—*Robinson v. Denver City Tramway Co.* (C. C. A.) 174.

§ 1022. Where a cause is referred to a master, to take proof and to report on certain questions, and this is done, and the court concurs in the conclusions of the master, they are to be taken as presumptively correct, and should be permitted to stand, unless some obvious error or mistake has intervened, either in the law or in the consideration of the evidence.—*City of Memphis v. Postal Telegraph & Cable Co.* (C. C. A.) 600.

§ 1009. The finding of the court in a suit in equity must be taken as presumptively correct and unless an obvious error has intervened in the application of the law or some serious or important mistake has been made in the consideration of the evidence such findings will not be disturbed by the appellate court.—*Thorndyke v. Alaska Perseverance Mining Co.* (C. C. A.) 657.

§ 1074. The parties to an appeal held not prejudiced because the court entered a decree dismissing the appeal, instead of a decree of affirmance, which would have been the proper form.—*Corcoran v. Kostrometinoff* (C. C. A.) 685.

§ 931. The legal presumption is that findings of the master on conflicting evidence are correct, and they will not be set aside unless it appears that he has fallen into a mistake of fact or committed an error of law.—*Guarantee Gold Bond Loan & Saving Co. v. Edwards* (C. C. A.) 809.

§ 1054. The admission in evidence in a suit in equity of a paper purporting to be an opinion given by counsel for complainant expressing doubt as to the right of recovery, even if not properly admissible, is not ground for reversal of the decree on the merits.—*Ajax Forge Co. v. Morden Frog & Crossing Works* (C. C. A.) 843.

§ 1009. It is a well-established rule that an appellate court will not ordinarily interfere with the action of a trial court in either granting or withholding an injunction in cases in which the evidence is substantially conflicting, and especially where the trial judge at the request of the respective parties has had the benefit of a personal inspection of the premises which are the subject of controversy.—*McCarthy v. Bunker Hill & Sullivan Mining & Concentrating Co.* (C. C. A.) 927.

§ 1010. The finding of a circuit court on a question of fact in an action at law tried by stipulation without a jury is conclusive on a reviewing court if there is any evidence in its support.—*Pacific Sheet Metal Works v. Californian Canneries Co.* (C. C. A.) 980.

*Point annotated. See syllabus.

APPLICATION.

For new trial in criminal prosecutions, see Criminal Law, § 3.

APPOINTMENT.

Of trustee in bankruptcy, see Bankruptcy, § 2.

APPORTIONMENT.

Of salvage compensation, see Salvage, § 1.

APPRAISAL.

Of imported goods, see Customs Duties, § 3.
Of merchandise subject to duty, see Customs Duties, § 3.

APPROPRIATION.

Of water rights in general, see Waters and Water Courses, § 2.
Of water rights in public lands, see Waters and Water Courses, § 1.

ARMY AND NAVY.

Right of alien enlisted in navy to naturalization as dependent on continuous residence in country, see Aliens, § 3.

ARREST.

See Bail.

ASSENT.

To reference, see Equity, § 5.

ASSESSMENT.

Of compensation for property taken for public use, see Eminent Domain, § 1.
Of tax, see Taxation, § 2.

ASSIGNMENTS.

Fraud as to creditors, see Fraudulent Conveyances.
In bankruptcy, see Bankruptcy, § 3.
Of patents, see Patents, § 5.

§ 1. Requisites and validity.

*The mere giving of a check on an ordinary deposit account in a bank, in the usual course of business, in payment of a past indebtedness, does not amount to an equitable assignment, even though the drawer makes a deposit expressly to cover the check; and a garnishment of the bank, after other deposits have been made and checks given, but before such check has been presented, creates a lien on the de-

posit superior to the rights of the payee.—*Poland v. Love* (C. C. A.) 186.

*An executory contract for future delivery of personal property, not dependent on future dealings with the property sold between the parties, is assignable, in the absence of any provision to the contrary, although it provides for a term of credit to be given the purchaser, provided the assignor offers to relieve the seller from giving such credit and to pay cash on delivery.—*In re Niagara Radiator Co.* (D. C.) 102.

ASSIGNMENTS FOR BENEFIT OF CREDITORS.

See Bankruptcy, §§ 2-7.

ASSUMPTION.

Of risk by employé, see Master and Servant, § 1.

AUTHORITY.

Of broker, see Brokers, § 1.

BAIL.**§ 1. In criminal prosecutions.**

§ 60. A bail bond given by a surety company for the appearance of a defendant in a criminal case in a federal court, as authorized by Act Aug. 13, 1894, c. 282, 28 Stat. 279 (U. S. Comp. St. 1901, p. 2315), differs in no way, so far as its legal status is concerned, from the bond of an individual surety.—*Ex parte Mar- rin* (D. C.) 631.

BAILMENT.

See Pledges.

BANKRUPTCY.

Conflicting jurisdiction of courts of bankruptcy and admiralty, see Courts, § 3.

§ 1. Petition, adjudication, warrant, and custody of property.

*An order of a state court, appointing a receiver for a corporation on a petition charging insolvency does not constitute an act of bankruptcy, under Bankr. Act July 1, 1898, c. 541, § 3a (4), 30 Stat. 546 (U. S. Comp. St. 1901, p. 3422), as amended by Act Feb. 5, 1903, c. 487, § 2, 32 Stat. 797 (U. S. Comp. St. Supp. 1907, p. 1025), where it is made to appear by an amendment of such order that it was not based on a finding that the corporation was insolvent, as the word is defined in the bankruptcy act.—*In re Golden Malt Cream Co.* (C. C. A.) 326; *National Chemical Co. v. Golden Malt Cream Co.*, Id.

§ 76. Under Const. Cal. art. 12, § 3, as construed by the Supreme Court of the state the

*Point annotated. See syllabus.

liability of a director in an insolvent savings bank incorporated under the laws of the state whose funds have been embezzled or misappropriated by its officers to depositors in such bank is a fixed liability absolutely owing within Bankr. Act July 1, 1898, c. 541, § 63a (1), 30 Stat. 562 (U. S. Comp. St. 1901, p. 3447), and such depositors are creditors who may join in a petition in involuntary bankruptcy against a director.—In re Brown (C. C. A.) 673; Brown v. Major, Id; In re Bartnett (C. C. A.) 679; Bartnett v. Major, Id.

§ 76. Under Const. Cal. art. 12, § 3, and Civ. Code, § 322, and Code Civ. Proc. § 359, depositors in an insolvent savings bank within three years are creditors of a stockholder to the extent of his proportion of its indebtedness to them and their claims are provable in bankruptcy and entitle them to join in an involuntary petition against him.—Walker v. Woodside (C. C. A.) 680; In re Walker, Id.

§ 82. A petition in involuntary bankruptcy in which a corporation and a partnership join may be verified for the corporation by its president and for the partnership by one of its members.—Walker v. Woodside (C. C. A.) 680; In re Walker, Id.

§ 84. Acts of bankruptcy not alleged in an involuntary petition, nor in an intervening petition by other creditors cannot be set up by an amendment to either where they were committed more than four months before such amendment is made.—Walker v. Woodside (C. C. A.) 680; In re Walker, Id.

§ 100. An adjudication of bankruptcy based on a finding that because of insolvency a receiver was appointed for the property of the alleged bankrupt under the laws of a state which is made an act of bankruptcy by Bankr. Act July 1, 1898, c. 541, § 3a(4), 30 Stat. 46 (U. S. Comp. St. 1901, p. 3422), as amended by Act Feb. 5, 1903, v. 487, § 2, 32 Stat. 797 (U. S. Comp. St. Supp. 1907, p. 1025), is conclusive as to such fact, and cannot be collaterally attacked.—In re Hecox (C. C. A.) 823; Hecox v. Rollestone, Id.

A receiver for a bankrupt, who under authority of the court assumed an executory contract made by the bankrupt, held to have succeeded to the latter's right to enforce the same and to recover damages for the failure of the other party to perform.—In re Niagara Radiator Co. (D. C.) 102.

§ 28. An involuntary bankrupt is subject to punishment for contempt of court for a failure to file his schedules within 10 days after the adjudication, as required by Bankr. Act July 1, 1898, c. 541, § 7, 30 Stat. 548 (U. S. Comp. St. 1901, p. 3424), and by the order of adjudication.—In re Schulman & Goldstein (D. C.) 440.

§ 58. A creditor of a bankrupt, who at the time of receiving a preference was put on inquiry as to the solvency of the debtor, was not for that reason charged with notice of facts which could only be learned from intimate and inaccessible sources of information, such as the books of the bankrupt, but was bound only by such information as could be obtained by open

observation and reasonable inquiry.—In re Wolf Co. (D. C.) 448.

§ 58. A creditor of a bankrupt, who received a preference, held not chargeable with knowledge of facts which gave him reasonable cause to believe the debtor insolvent, so as to render the preference voidable.—In re Wolf Co. (D. C.) 448.

§ 71. Where a corporation, being insolvent, commits acts of bankruptcy by preferring certain creditors, the jurisdiction of a court of bankruptcy to adjudicate it a bankrupt and administer its estate under the provisions of the bankruptcy act (Act July 1, 1898, c. 541, 30 Stat. 544 [U. S. Comp. St. 1901, p. 3418]) attaches, and the corporation cannot avoid such jurisdiction and validate its preferences by instituting proceedings for dissolution in a state court before bankruptcy proceedings against it are instituted.—In re Adams & Hoyt Co. (D. C.) 489.

§ 20. A corporation may be adjudged an involuntary bankrupt, where the petition alleges sufficient grounds, notwithstanding the fact that a receiver was appointed for its property by a state court more than four months prior to the filing of the petition, who is still in possession.—In re Sterlingworth Ry. Supply Co. (D. C.) 591.

§ 2. Assignment, administration, and distribution of bankrupt's estate —Appointment, qualification, and tenure of trustee.

Where three trustees are elected for a bankrupt corporation, it is no ground of objection that one of them is a director of the corporation; and, in case it becomes the duty of the trustees to bring an action against the directors, such action may be brought by the other two, making their co-trustee a defendant as director.—In re Syracuse Paper & Pulp Co. (D. C.) 275.

Oral unverified objections to proved claims against the estate of a bankrupt, made at the first meeting of creditors, held not sufficient to require the referee to postpone the election of trustee, and properly overruled.—In re Syracuse Paper & Pulp Co. (D. C.) 275.

That a creditor of a bankrupt corporation is a stockholder or director of the corporation, or was an employé, does not deprive him of the right to participate in the election of a trustee.—In re Syracuse Paper & Pulp Co. (D. C.) 275.

§ 123. The election of a trustee for a bankrupt vacated, and a new meeting ordered, where no notice of the meeting was given to one claiming to be a creditor, and who, as had previously been expressly determined by the court, was entitled to be treated as a creditor, the same as others claiming to be creditors, until the validity of his claim should be duly passed on.—In re Evening Standard Pub. Co. (D. C.) 517.

§ 3. — Assignment, and title, rights, and remedies of trustee in general.

§ 140. Where a debtor in Kansas made a general assignment and was subsequently adjudicated a bankrupt, under Bankr. Act July

1, 1898, c. 541, §§ 67a, 67b, 30 Stat. 564 (U. S. Comp. St. 1901, p. 3449), the trustee was subrogated to the right of the assignee under the state law to property held by the bankrupt under an unrecorded contract of conditional sale, as against the seller.—In re Fish Bros. Wagon Co. (C. C. A.) 553.

§ 140. A contract under which a bankrupt was in possession of personal property held one of lease and not of sale, and the lessor held entitled to reclaim the property from the trustee.—McEwen v. Totten (C. C. A.) 837.

A bankrupt is not permitted to withhold his books from his trustee on his mere assertion that they contain evidence which would tend to incriminate him; but, if the court or referee finds such to be the fact, a proper order may be made protecting him from the use of such evidence in any criminal proceeding.—In re Harris (D. C.) 292.

§ 143. Under Ky. St. 1903, § 655, a policy of insurance on the life of a bankrupt, payable to his wife, does not pass to his trustee.—In re Pfaffinger (D. C.) 526.

§ 143. Where policies of insurance on the life of a bankrupt were payable to his wife, they did not pass to his trustee in bankruptcy because of the fact that by their terms the bankrupt was authorized to change the beneficiary with the consent of the company, nor because, after the bankruptcy, he applied in his own name for their surrender value, which the company did not pay him.—In re Pfaffinger (D. C.) 526.

§ 136. A finding by a referee that at the time of his bankruptcy a bankrupt had in his possession or under his control money or property of his estate, which he withheld from his trustee, does not warrant an order, seven years afterward, requiring him to turn the same over to his trustee; it not being shown that he is then able to comply with such order.—In re Ruos (D. C.) 749.

§ 136. An order requiring a bankrupt to turn over money or property to his trustee should be made only after a hearing on a partition therefor, making definite averments on the subject and offering a definite issue, upon which both parties may adduce evidence.—In re Ruos (D. C.) 749.

§ 4. — Preferences and transfers by bankrupt, and attachments and other liens.

A purchaser of property from a bankrupt which had made advances on the purchase did not by obtaining delivery within four months prior to the bankruptcy, and while the bankrupt was insolvent, secure a preference as a creditor which it was required to surrender before proving a secured claim.—Mills v. Virginia-Carolina Lumber Co. (C. C. A.) 163.

§ 207. A title or lien acquired by an assignee under a general assignment valid according to the law of the state where it is made, that is to the advantage of the estate when it has subsequently passed into bankruptcy, is not necessarily destroyed by the supersession of the assignment proceeding; but upon the or-

der of the court of bankruptcy it may be retained by the trustee for the benefit of the creditors.—In re Fish Bros. Wagon Co. (C. C. A.) 553.

§ 160. The fact that a corporation engaged in the performance of a contract which required a considerable expenditure before it was entitled to payment thereunder arranged with a bank for making overdrafts is no evidence that it was insolvent at the time within the meaning of Bankr. Act July 1, 1898, c. 541, § 1, subd. 15, 30 Stat. 545 [U. S. Comp. St. 1901, p. 3419].—McDonald v. Clearwater Shortline Ry. Co. (C. C.) 1007.

§ 165. A transfer of property by a borrower at the time of receiving a loan and for the purpose of making the lender safe is security, and its validity, if not accompanied by positive fraud, is recognized and enforced in bankruptcy.—McDonald v. Clearwater Shortline Ry. Co. (C. C.) 1007.

§ 166. Evidence considered, and held insufficient to establish a voidable preference by a bankrupt corporation.—McDonald v. Clearwater Shortline Ry. Co. (C. C.) 1007.

Where the effect of a conveyance by an insolvent to a creditor within four months prior to his bankruptcy was to give such a creditor a preference over other creditors, it will be conclusively presumed that it was so intended, and the conveyance is voidable if it is shown that the creditor knew or had reason to believe such fact.—Brewster v. Goff Lumber Co. (D. C.) 124.

A creditor of a partnership which obtained a conveyance of his home property from one of the partners at a time when both the partnership and its members were insolvent, and within four months prior to their bankruptcy, held, under the evidence, chargeable with knowledge of facts which gave it reasonable cause to believe that a preference was intended which rendered the conveyance voidable at suit of the trustee.—Brewster v. Goff Lumber Co. (D. C.) 124.

*A creditor who secured the conveyance of the residence of an insolvent debtor within four months of the latter's bankruptcy held to have had knowledge of such facts as to give him reasonable cause to believe that a preference was intended and to render the conveyance voidable.—Brewster v. Goff (D. C.) 127.

Where a voidable preference was made by a bankrupt to mother of creditor, who paid the consideration, which was applied to the bankrupt's account, a bill setting aside a conveyance brought by the trustee of the bankrupt will be sustained as against the mother and a third person, to whom she conveyed after suit brought.—Brewster v. Goff (D. C.) 127.

Under Civ. Code S. C. 1902, § 2456, the holder of a mortgage given by a bankrupt which was not recorded within 40 days has no interest in the proceeds of the mortgaged property, unless or until all subsequent creditors of the bankrupt have been paid in full.—In re J. C. H. Claussen & Co. (D. C.) 300; Greer v. Simons, Id.

*Point annotated. See syllabus.

§ 164. Payments made to a creditor by a partnership within a few days prior to its bankruptcy *held*, under the evidence, to constitute voidable preferences, which the creditor was required to repay before proving a claim against the estate.—In re Rice (D. C.) 514.

§ 175. A pretended sale of goods by a bankrupt a few days prior to his bankruptcy *held* fraudulent, and void, and to convey no title as against creditors, but merely a device to apparently transfer the title while the ownership of the goods in fact remained in the bankrupt.—In re Siegel (D. C.) 559.

§ 178. A mortgage, taken by the wife of a bankrupt for the purchase price of property transferred to her by her husband with intent to defraud his creditors, and subsequently sold to a third party, *held* recoverable by his trustee in bankruptcy, under Bankr. Act July 1, 1898, c. 541, § 70e, 30 Stat. 566 (U. S. Comp. St. 1901, p. 3452).—Prescott v. Galluccio (D. C.) 618.

§ 217. An order staying a judgment creditor of a bankrupt from proceeding to collect his judgment until the bankrupt's right to a discharge has been disposed of will not be vacated because, under Code Civ. Proc N. Y. § 1391, as amended by Laws 1908, p. 433, c. 148, the creditor is entitled to take on execution 10 per cent. of the debtor's salary.—In re Van Buren (D. C.) 883.

§ 5. — Administration of estate.

A court of bankruptcy has no power to commit any person for a contempt committed before a referee, except strictly in accordance with the provisions of Bankr. Act July 1, 1898, c. 541, § 41b, 30 Stat. 556 (U. S. Comp. St. 1901, p. 3437), which requires that the proceedings shall be based on a certificate of the referee.—In re Gitkin (D. C.) 71.

*A bankrupt, who on his examination before the referee, deliberately and willfully swears falsely, or falsely denies knowledge of matters about which he is interrogated, refuses "to be examined according to law," and is guilty of contempt, under Bankr. Act. July 1, 1898, c. 541, § 41a (4), 30 Stat. 556 (U. S. Comp. St. 1901, p. 3437).—In re Gitkin (D. C.) 71.

Under general orders in bankruptcy No. 27 (89 Fed. xi, 32 C. C. A. xxvii), which provides for review of an order of a referee by the district judge on petition filed with the referee setting out the error complained of, such mode of review is exclusive, and a referee has no authority to review his own orders on exceptions thereto, nor is a party entitled to a review by the judge, except on a petition filed in accordance with such rules as may be adopted by the court.—In re Greek Mfg. Co. (D. C.) 211.

§ 224. The powers of a special referee, appointed on petition of a receiver for the property of an alleged bankrupt pending a hearing on the petition, with authority to examine the bankrupt and other witnesses in relation to the property and assets of the bankrupt, were superseded on the making of an adjudication and an order of general reference.—In re Ruos (D. C.) 749.

§ 6. — Actions by or against trustee.

§ 293. A petition by trustees in bankruptcy against sureties on a bail bond given by the bankrupt, to recover a deposit made with them as security, *held* not within the jurisdiction of the District Court without the defendants' consent, under Bankr. Act July 1, 1898, c. 541, 30 Stat. 552 (U. S. Comp. St. 1901, p. 3431), § 23b, as amended by Act Feb. 5, 1903, c. 487, 32 Stat. 798 (U. S. Comp. St. Supp. 1907, p. 1028).—In re Horgan (C. C. A.) 415; In re Reagan, Id.; Eldredge v. Horgan, Id.

§ 293. On an adjudication in bankruptcy and the appointment of a trustee, he is entitled to the possession of property of the bankrupt in the possession of a receiver appointed by a state court within four months, and, if such right is not recognized by the receiver or the court which appointed him, it is competent for, and the duty of, the bankruptcy court to enforce it.—In re Hecox (C. C. A.) 823; Hecox v. Rollestone, Id.

§ 302. A bill by a trustee in bankruptcy to recover property fraudulently conveyed by the bankrupt, under Bankr. Act July 1, 1898, c. 541, § 70e, 30 Stat. 566 (U. S. Comp. St. 1901, p. 3452), should allege that the property of the bankrupt is insufficient to pay his debts in full; but where no objection is made on that ground, and the proof shows such fact, the omission may be supplied by amendment.—Prescott v. Galluccio (D. C.) 618.

§ 7. — Claims against and distribution of estate.

Evidence *held* to show that a bankrupt purposely concealed his insolvency to enable him to obtain goods on credit which he did not intend to pay for.—In re Friedman (D. C.) 131.

On a contest of claims filed by certain relatives against the estate of a bankrupt, where it was clearly shown that the bankrupt fraudulently concealed his insolvency for the purpose of securing a large stock of goods on credit without intending to pay for the same, and that the claimants had been closely associated with him in business transactions, evidence was admissible to show that they had previously been associated together in similar fraudulent transactions.—In re Friedman (D. C.) 131.

When a creditor of a bankrupt participates in a scheme to defraud other creditors, and in furtherance thereof advances money or incurs expense, the entire transaction is contaminated by the fraud, and the court will not assist the conspirators by allowing claims for such advances against the estate.—In re Friedman (D. C.) 131.

Where a creditor of a bankrupt makes a claim, the larger part of which is fraudulent, he is not entitled to the allowance of any part thereof.—In re Friedman (D. C.) 131.

Evidence considered, and *held* to establish a conspiracy between a bankrupt and certain relatives to defraud the creditors of the bankrupt, which required the court to disallow claims of such relatives as creditors.—In re Friedman (D. C.) 131.

*Point annotated. See syllabus.

A note given by a bankrupt to his wife is provable against his estate, regardless of the consideration therefor, where it is not shown that the bankrupt was indebted at the time it was given.—In re Kyte (D. C.) 302.

§ 318. Where a bankrupt lessee at the time of its bankruptcy was in default for rent by reason of which fact the rent for the entire term was due and payable under the terms of the lease, such rent, so far as it was definitely fixed by the lease, was a fixed liability, absolutely owing and provable in bankruptcy, under Bankr. Act July 1, 1898, c. 541, § 63a (1), 30 Stat. 562 (U. S. Comp. St. 1902, p. 3447); but claims for taxes and insurance premiums on the property which the lessee also covenanted to pay as a part of the rent, but which were not due at the time of the bankruptcy, nor the amount then capable of ascertainment, are not so provable.—In re Pittsburg Drug Co. (D. C.) 482.

§ 350. The claim of a landlord against a bankrupt for one year's rent, which, although the year had not expired, had become due and payable under the terms of the lease because of the bankrupt's default, held entitled to priority from the proceeds of property on the premises subject to distraint, under Bankr. Act July 1, 1898, c. 541, § 64b (5), 30 Stat. 563 (U. S. Comp. St. 1901, p. 3448) and Act Pa. June 16, 1836 (P. L. 777) § 83.—In re Pittsburg Drug Co. (D. C.) 482.

§ 351. While the trustee of a bankrupt partner may prove a claim for advancements made by such partner to the firm against the estate in bankruptcy of the partnership, under Bankr. Act July 1, 1898, c. 541, § 5f, 30 Stat. 548 (U. S. Comp. St. 1901, p. 3424), such claim is not entitled to share with other partnership creditors in the estate, but only in the surplus, if any, remaining after their claims are paid in full.—In re Rice (D. C.) 509, 514.

§ 348. Musicians, employed at regular wages to play in a theater or other place, are "servants," within the meaning of Bankr. Act July 1, 1898, c. 541, § 64b (4), 30 Stat. 563 (U. S. Comp. St. 1901, p. 3447), and entitled to priority of payment from the estate of the employer in bankruptcy for their wages earned within three months.—In re Caldwell (D. C.) 515.

§ 8. Rights, remedies, and discharge of bankrupt.

§ 399. The exemption law of Georgia construed and a bankrupt held not entitled to an exemption from the proceeds of mortgaged property sold by the trustee by consent as against the mortgagee in whose favor he waived his right of exemption.—Citizens' Bank of Douglas, Ga., v. Hargraves (C. C. A.) 613.

§ 414. Where the granting of a discharge to a bankrupt was objected to on the ground that he fraudulently concealed the proceeds of property sold and there was reasonable ground for the action of the District Judge in discrediting his testimony in explanation, the exercise of his discretion will not be reviewed.—Seigel v. Cartel (C. C. A.) 691.

§ 417. A petition to set aside a discharge and reopen bankruptcy proceedings held insufficient.—Vary v. Jackson (C. C. A.) 840.

A petition filed by a bankrupt more than a year after the adjudication, asking an extension of time for filing an application for discharge on the ground that he was unavoidably prevented from filing it within the year allowed therefor, is not evidence of the facts therein alleged, and on a reference of such petition they must be sustained by proof, although no formal answers may be filed thereto.—In re Glickman & Pisonoff (D. C.) 209.

*A refusal of a discharge to a bankrupt on the ground that he failed to keep books is not warranted, unless there is evidence from which at least it can fairly be inferred that there was an actual intent to conceal his condition. Mere negligence in the keeping of books is not sufficient.—In re Haskell (D. C.) 301.

§ 399. A bankrupt held not entitled to exemptions under the law of Pennsylvania, on the ground that he concealed property with intent to defraud his creditors.—In re Rice (D. C.) 589.

§ 400. General orders in bankruptcy No. 17, authorizing creditors to except to the allowance of the bankrupt's exemptions, does not exclude the trustee, who may except on behalf of all of the creditors to such allowance on the ground of the bankrupt's fraud.—In re Rice (D. C.) 589.

§ 414. Evidence held to sustain the finding of a referee that the failure of a bankrupt to keep such books of account as would disclose his financial condition was intentional and with a purpose to conceal such condition, and that he was therefore not entitled to a discharge.—In re Goldich (D. C.) 882.

§ 9. Appeal and revision of proceedings.

An appeal from a decision of a District Court in bankruptcy can be treated as a petition for review only where questions of law are alone involved.—Gaudette v. Graham (C. C. A.) 311; In re Blanchard Shingle Co., Id.

An order of a District Court allowing a claim against an estate in bankruptcy as a general debt, but disallowing in part a claim of the creditor to priority as a lien holder, is not appealable by the creditor, under Bankr. Act July 1, 1898, c. 541, § 25a (3), 30 Stat. 553 (U. S. Comp. St. 1901, p. 3432); nor is it subject to revision on petition under section 24b, where it depends on controverted facts.—Gaudette v. Graham (C. C. A.) 311; In re Blanchard Shingle Co., Id.

§ 467. Where a bankrupt fails to schedule or to surrender to his trustee goods shown to have been in his possession a short time prior to his bankruptcy, the burden rests upon him to account for the same, and, if he fails to do so, the presumption is that he sold them and conceals the proceeds.—Seigel v. Cartel (C. C. A.) 691.

§ 441. A petition by a trustee in bankruptcy to a court of bankruptcy for a summary order on a receiver of a state court to deliver prop-

*Point annotated. See syllabus.

erty to the petitioner is a proceeding in bankruptcy, and the order made thereon is reviewable by the Circuit Court of Appeals in matter of law on a petition to revise under Bankr. Act July 1, 1898, c. 541, § 24b, 30 Stat. 553 (U. S. Comp. St. 1901, p. 3432).—*In re Hecox* (C. C. A.) 823; *Hecox v. Rolleston*, Id.

§ 444. An appeal in bankruptcy will be dismissed where citation was not issued nor the assignment of errors filed until after a term of the Circuit Court of Appeals had intervened, and the transcript was not filed until after a second term had passed, and no showing was made in excuse of the delay.—*Nazima Trading Co. v. Martin* (C. C. A.) 838.

§ 10. Costs and fees.

*A mortgage creditor of a bankrupt who proves his claim for the purpose of enforcing his lien on the proceeds of the mortgaged property which has been sold by the trustee does not thereby become liable for his proportionate share of the costs of the general administration of the estate.—*Mills v. Virginia-Carolina Lumber Co.* (C. C. A.) 168.

The attorney for a mortgagee of a bankrupt who was permitted to sell the mortgaged property and hold the proceeds subject to the orders of the bankruptcy court, and is subsequently adjudged to have no interest therein, is not entitled to an allowance from the fund for services rendered, except in so far as such services contributed to create or conserve such fund for the benefit of the estate.—*In re J. C. H. Claussen & Co.* (D. C.) 300; *Greer v. Simmons*, Id.

BANKS AND BANKING.

Personal liability of guardian for loss of funds deposited on time certificate without security, see *Guardian and Ward*, § 1.

Requisites and validity of assignment of bank deposit, see *Assignments*, § 1.

Right of depositors in insolvent bank to maintain petition in bankruptcy against stockholder or director, see *Bankruptcy*, § 1.

§ 1. National banks.

§ 246. A stockholder in a national bank, on giving notice of withdrawal when the charter of the bank is renewed, as provided by Act July 12, 1882, c. 290, § 5, 22 Stat. 163 (U. S. Comp. St. 1901, p. 3458), ceases at once to be a stockholder.—*Kimball v. Apsey* (C. C. A.) 830.

§ 248. A stockholder in a national bank, who gave notice of withdrawal on the renewal of its charter, as permitted by Act July 12, 1882, c. 290, § 5, 22 Stat. 163 (U. S. Comp. St. 1901, p. 3458), and took all reasonable measures to have his stock appraised and paid for, held not liable, on the ground of estoppel, for an assessment made on the subsequent appointment of a receiver for the bank.—*Kimball v. Apsey* (C. C. A.) 830.

BAR.

Of action by former adjudication, see *Judgment*, § 4.

*Point annotated. See syllabus.

BEST AND SECONDARY EVIDENCE.

In criminal prosecutions, see *Criminal Law*, § 1.

BILL OF EXCHANGE.

See *Bills and Notes*.

BILLS AND NOTES.

Alteration of note, see *Alteration of Instruments*.

Note as basis of claim against estate of bankrupt, see *Bankruptcy*, § 7.

§ 1. Rights and liabilities on indorsement or transfer.

§ 296. A bank, which indorsed a check on another bank, the indorsement of which by the payee was forged, expressly guaranteeing the indorsements, and received payment thereof, held liable to the bank which paid it in reliance on such guaranty.—*Boardman v. Hanna* (C. C.) 527.

§ 2. Presentment, demand, notice, and protest.

Indorsers of a note held, under *Negotiable Instrument Act Pa.*, May 16, 1901 (P. L. 206, 209), § 80, 115, not relieved from liability by the failure of the holder to present it for payment at maturity or to give notice of its dishonor.—*Luckenbach v. McDonald* (C. C.) 296; *Same v. Kunzig*, Id.

BONDS.

Importers' bonds, see *Customs Duties*, § 3. In judicial proceedings, see *Appeal and Error*, § 2; *Bail*.

BREACH.

Of contract, see *Contracts*, § 3.

Of warranty, see *Sales*, § 4.

BROKERS.

§ 1. Employment and authority.

§ 11. Where an owner of land employed a broker to sell the same, and he procured a purchaser who proposed to organize a corporation to take over the property, and the broker was to be paid by the bonds of the corporation, and the owner refused to perform, it was not essential to an action by the broker for breach of contract that the proposed corporation should be brought into being or that it should ratify the purchaser's engagement respecting the issue of bonds.—*T. C. Henry & Sons & Co. v. Colorado Farm & Live Stock Co.* (C. C. A.) 986.

§ 11. Where an owner of land procured a broker to obtain a purchaser, and refused to complete the sale, such owner obligated himself to the broker, and the refusal was a breach of that obligation.—*T. C. Henry & Sons & Co. v. Colorado Farm & Live Stock Co.* (C. C. A.) 986.

§ 10. Correspondence between parties to a contract of agency for sale of land construed, and held to operate as a rescission of such contract.—*Lacey v. Thomas* (C. C.) 623.

BURDEN OF PROOF.

In criminal prosecutions, see *Criminal Law*, § 1.

CANALS.

§ 1. Regulation and operation.

Act Aug. 18, 1894, c. 299, § 4, 28 Stat. 362 (U. S. Comp. St. 1901, p. 3525), authorizing the Secretary of War to make rules and regulations for the operation of canals owned, operated, or controlled by the United States, and making their violation a criminal offense, is constitutional.—*United States v. Moody* (D. C.) 269.

Rules promulgated by the Secretary of War for the government of St. Mary's Falls Canal, requiring vessels navigating the same to obey the instructions of the superintendent and his assistants, held valid, and a refusal to obey such instructions is a violation of the rules.—*United States v. Moody* (D. C.) 269.

CANCELLATION OF INSTRUMENTS.

Cancellation of patent to public land, see *Public Lands*, § 1.

§ 1. Proceedings and relief.

Evidence considered, and held insufficient to authorize a decree for the cancellation of written contracts on the ground of fraud, under the rule that in such case it must be sufficient to sustain a verdict convicting defendant of obtaining property by false pretenses.—*Fairchild v. Dement* (C. C.) 200.

CARGO.

See *Shipping*.

CARRIERS.

Breach of contract to furnish cars, see *Contracts*, § 3.

Constitutional power of courts to inquire into reasonableness of rates fixed by interstate commerce commission, see *Constitutional Law*, § 1.

Interstate commerce regulations as to safety appliances, see *Commerce*, § 2.

§ 1. Control and regulation of common carriers.

§ 38. In a prosecution of a shipper for accepting a concession in violation of Elkins Act Feb. 19, 1903, c. 708, 32 Stat. 847, § 1 (U. S. Comp. St. Supp. 1907, p. 880), evidence that the shipper had no knowledge of the legal published rate was admissible as bearing on the shipper's intent.—*Standard Oil Co. of Indiana v. United States* (C. C. A.) 376.

§ 38. In a prosecution of a shipper for violating Elkins Act Feb. 19, 1903, c. 708, 32 Stat. 847, § 1 (U. S. Comp. St. Supp. 1907, p. 880), in receiving a concession in rates, each offense consists of a completed transaction in interstate or foreign commerce by which the shipper has been permitted to ship at a rate lower than the published rate.—*Standard Oil Co. of Indiana v. United States* (C. C. A.) 376.

§ 38. Assessment of a fine of \$29,240,000 for 1,462 violations of Elkins Act Feb. 19, 1903, c. 708, 32 Stat. 847, § 1 (U. S. Comp. St. Supp. p. 880), against the Standard Oil Company of Indiana, held excessive and an abuse of discretion.—*Standard Oil Co. of Indiana v. United States* (C. C. A.) 376.

§ 26. The legality of a terminal charge fixed by railroad companies for the moving of cars of live stock from the ends of their tracks in Chicago to the Union Stockyards and separately stated in their schedules as required by section 6 of the interstate commerce act (Act Feb. 4, 1887, c. 104, 24 Stat. 380 [U. S. Comp. St. 1901, p. 3156], as amended by Act June 29, 1906, c. 3591, § 2, 34 Stat. 586 [U. S. Comp. St. Supp. 1907, p. 895]), must be determined alone by its reasonableness for the service covered thereby, without reference to the other rates; and the Interstate Commerce Commission is without power to reduce such charge, when reasonable in itself, on the ground that, when added to the rate over their own lines, the total through rate is excessive.—*Stickney v. Interstate Commerce Commission* (C. C.) 638.

§ 26. Maximum rates prescribed by the Interstate Commerce Commission, to be just and reasonable and within the constitutional limitation, must have reasonable regard for the cost to the carrier of the service rendered and the value of the property employed therein, but also reasonable regard for the value of the service to the public.—*Missouri, K. & T. R. Co. v. Interstate Commerce Commission* (C. C.) 645.

§ 32. Rates prescribed by the Interstate Commerce Commission under the statute are not only required to be just and reasonable within the constitutional guaranty, but they must also not be unjustly discriminating nor unduly preferential.—*Missouri, K. & T. R. Co. v. Interstate Commerce Commission* (C. C.) 645.

§ 2. Carriage of goods.

§ 91. Under the provisions of sections 15 and 16 of the interstate commerce act (Act Feb. 4, 1887, c. 104, 24 Stat. 384 [U. S. Comp. St. p. 3165], as amended by Act June 29, 1906, c. 3591, §§ 4, 5, 34 Stat. 589, 590 [U. S. Comp. St. Supp. 1907, pp. 900, 902]), the courts have jurisdiction to set aside or suspend any order of the Interstate Commerce Commission resulting from a misconception and misapplication of the law to conceded or undisputed facts.—*Stickney v. Interstate Commerce Commission* (C. C.) 638.

§ 3. Carriage of live stock.

§ 211. Act June 29, 1906, c. 3594, § 1, 34 Stat. 607 (U. S. Comp. St. Supp. 1907, p. 918), known as the 28-hour law, is not a criminal

*Point annotated. See syllabus.

statute, nor subject to the strict rules of construction applied to such statutes.—*Montana Cent. Ry. Co. v. United States (C. C. A.) 400.*

§ 211. In an action against a railroad company to recover the penalty for violation of the 28-hour law (Act June 29, 1906, c. 3594, § 1, 34 Stat. 607 [U. S. Comp. St. Supp. 1907, p. 918]), it is not a defense that such violation was by reason of the "oversight, forgetfulness, and unintentional neglect" of defendant's train dispatchers, contrary to its rules and orders.—*Montana Cent. Ry. Co. v. United States (C. C. A.) 400.*

§ 4. Carriage of passengers.

§ 306. A railroad company which entered into a contract entitling it to use station premises jointly with other companies came under the same duty as to passengers using the premises in connection with the other roads that it owed to its own passengers, and was required to operate its trains with the same due regard for their safety.—*Chicago, R. I. & P. Ry. Co. v. Stepp (C. C. A.) 785.*

§ 238. In an action against a railroad company to recover for the death of a person killed at a station by defendant's train, *held* that he was a passenger and that the questions of negligence and contributory negligence were properly submitted to the jury.—*Chicago, R. I. & P. Ry. Co. v. Stepp (C. C. A.) 785.*

§ 347. A passenger, before crossing a track at a railroad station while taking or leaving a train, is not required, as a matter of law, to look and listen for approaching trains, but is simply required to exercise reasonable care in the light of all the circumstances existing at the time, and whether he exercises that care is a question of fact for the jury.—*Chicago, R. I. & P. Ry. Co. v. Stepp (C. C. A.) 785.*

CASE ON APPEAL.

Necessity for purpose of review, see Appeal and Error, § 3.

CERTIFICATE.

Of secretary of state that application for extradition has been made as preliminary to issuance of warrant, see Extradition, § 1.

CHARGE.

By carrier, see Carriers, § 1.
To jury in civil actions, see Trial, § 3.

CHARTER PARTIES.

See Shipping, § 2.

CHATTEL MORTGAGES.

See Pledges.

§ 1. Rights and liabilities of parties.

§ 162. A chattel mortgagee rightfully in possession of the property after default can retain possession until the mortgage debt is paid, and it is error to adjudge him to pay to the mortgagor the difference between the amount of the debt and the value of the mortgaged property.—*Wagoner Nat. Bank v. Welch (C. C. A.) 813.*

§ 162. The right of a chattel mortgagor to the possession of the property is conditioned by the payment of the mortgage debt, but the right of the mortgagee to possession in not conditioned by his payment of the difference between the value of the property and the amount of the debt.—*Wagoner Nat. Bank v. Welch (C. C. A.) 813.*

CHECKS.

See Bills and Notes.

CHILDREN.

See Guardian and Ward.

Elements of damages for death of parent, see Death, § 1.

CHINESE.

Exclusion or expulsion, see Aliens, § 1.

CHOSE IN ACTION.

Assignment, see Assignments.

CIRCUIT COURTS OF APPEALS.

See Courts, § 2.

Jurisdiction of bankruptcy proceedings, see Bankruptcy, § 9.

CIRCUMSTANTIAL EVIDENCE.

In civil actions, see Evidence, § 3.

CITATION.

See Process.

CITIZENS.

See Aliens; Indians.

Citizenship ground of jurisdiction of United States courts, see Courts, § 2; Removal of Causes, § 3.

CLAIMS.

Against estate of bankrupt, see Bankruptcy, § 7.

Mining claims, see Mines and Minerals, § 1.
Of patent, see Patents, § 4.

*Point annotated. See syllabus.

CLERKS OF COURTS.

*An action will not lie against the clerk of a federal court in his official capacity to recover money received by him in such capacity and which passed into the registry of the court.—*Hills v. Valentine* (C. C. A.) 328.

COLLATERAL ATTACK.

On judgment, see Judgment, § 3.

COLLATERAL SECURITY.

See Pledges.

COLLECTION.

Of taxes, see Taxation, § 4.

COLOR OF TITLE.

To sustain adverse possession, see Adverse Possession.

COMBINATIONS.

See Conspiracy; Monopolies, § 1.

COMITY.

Between courts, see Courts, § 3.

COMMERCE.

Carriage of goods and passengers, see Carriers; Shipping.

Combinations in restraint of interstate commerce, see Monopolies, § 1.

Constitutional power of courts to inquire into reasonableness of rates fixed by commission, see Constitutional Law, § 1.

Fixing of rates by commission as depriving carrier of property without due process of law, see Constitutional Law, § 2.

Jurisdiction of federal court of actions based on interstate commerce act, see Courts, § 2.

§ 1. Power to regulate in general.

An enactment by Congress in the assumed exercise of its constitutional power to regulate interstate commerce is subject to review by the courts, to determine whether it is within such power as limited by the Constitution itself, and a legitimate and reasonable exercise thereof.—*United States v. Delaware & H. Co.* (C. C.) 215.

*Transportation of persons and property is commerce.—*United States v. Southern Ry. Co.* (D. C.) 347.

§ 2. Subjects of regulation.

§ 40. A corporation held to be engaged in interstate commerce.—*United States v. American Tobacco Co.* (C. C.) 700.

*Act March 2, 1893, c. 196, 27 Stat. 531 (U. S. Comp. St. 1901, p. 3174), and amend-

ments thereto (Act April 1, 1896, c. 87, 29 Stat. 85; Act March 2, 1903, c. 976, 32 Stat. 943 [U. S. Comp. St. Supp. 1907, p. 885]), known as the "Safety Appliance Acts," are not a violation of Const. U. S. Amend. 10.—*United States v. Southern Ry. Co.* (D. C.) 347.

*Congress, having determined to regulate the use of cars on interstate railroads, by said acts has taken affirmative action, and to this extent its action is exclusive.—*United States v. Southern Ry. Co.* (D. C.) 347.

*The reference in Safety Appliance Act March 2, 1903, c. 976, 32 Stat. 943 (U. S. Comp. St. Supp. 1907, p. 885), "to any railroad engaged in interstate commerce," and requiring vehicles running on interstate highways to be provided with certain appliances, embraces all uses of the highway, whether for the transportation of interstate traffic or for the transportation of traffic from a point within the state to another point in the same state by carriers engaged in interstate commerce.—*United States v. Southern Ry. Co.* (D. C.) 347.

*Employer's Liability Act June 11, 1906, c. 3073, 34 Stat. 232 (U. S. Comp. St. Supp. 1907, p. 891), is addressed to individuals or corporations engaged in interstate commerce, whereas Safety Appliance Act March 2, 1893, c. 196, 27 Stat. 531 (U. S. Comp. St. 1901, p. 3174), and amendments thereto (Act April 1, 1896, c. 87, 29 Stat. 85, and Act March 2, 1903, c. 976, 32 Stat. 943 [U. S. Comp. St. Supp. 1907, p. 885]), are addressed alone to the use of an instrument of interstate commerce, namely, an interstate railroad highway.—*United States v. Southern Ry. Co.* (D. C.) 347.

*Congress has power, not only under the commerce clause of the Constitution to regulate interstate commerce and the instrumentalities thereof, but also by virtue of its police power to provide for the protection of railroad employes and the traveling public; Appliance Act March 2, 1893, c. 196, 27 Stat. 531 (U. S. Comp. St. 1901, p. 3174), and amendments thereto (Act April 1, 1896, c. 87, 29 Stat. 85, and Act March 2, 1903, c. 976, 32 Stat. 943 [U. S. Comp. St. Supp. 1907, p. 885]), failure to provide vehicles with the safety appliances required by the acts is a violation thereof, when the cars are operated over any portion of an interstate highway, though that portion be from a point within a state to another point within the same state.—*United States v. Southern Ry. Co.* (D. C.) 347.

*Railroads engaged in interstate commerce are subjects of such commerce, national in their character, and the power of Congress over the same is exclusive and may be exercised to the utmost extent, and the sovereignty of Congress, though limited to specific objects, is plenary as to such objects.—*United States v. Southern Ry. Co.* (D. C.) 347.

*Act March 2, 1893, c. 196, 27 Stat. 531 (U. S. Comp. St. 1901, p. 3174) and amendments thereto (Act April 1, 1896, c. 87, 29 Stat. 85, and Act March 2, 1903, c. 976, 32 Stat. 943 [U. S. Comp. St. Supp. 1907, p. 885]), known as the "Safety Appliance Acts," are within the power conferred on Congress under Const.

U. S. art. 1, § 8, subd. 3, relating to the regulation of interstate commerce.—United States v. Southern Ry. Co. (D. C.) 347.

§ 3. Means and methods of regulation.

The power of Congress under the commerce clause of the Constitution to regulate interstate commerce does not include the power to entirely exclude from such commerce an article or commodity which is a legitimate and useful subject of commerce and not inimical to public safety, health, or morals, save when, and because, it is the property of a certain class of owners.—United States v. Delaware & H. Co. (C. C.) 215.

§ 4. Interstate commerce commission.

§ 91. The power of the court under sections 15, 16, of the interstate commerce act (Act Feb. 4, 1887, c. 104, 24 Stat. 384 [U. S. Comp. St. 1901, p. 3165], as amended by Act June 29, 1906, c. 3591, §§ 4, 5, 34 Stat. 589, 590 [U. S. Comp. St. Supp. 1907, pp. 900, 902]), to review orders of the Interstate Commerce Commission, considered.—Missouri, K. & T. R. Co. v. Interstate Commerce Commission (C. C.) 645.

COMMISSION.

Interstate commerce commission, see Commerce, § 4.

COMMISSIONERS.

In equity, see Equity, § 5.

COMMITMENT.

On conviction of crime, see Criminal Law, § 4.

COMMON CARRIERS.

See Carriers.

COMPETENCY.

Of evidence in criminal prosecution, see Criminal Law, § 1.

COMPETITION.

Unfair competition, see Trade-Marks and Trade-Names, § 2.

COMPLAINT.

In criminal prosecutions, see Indictment and Information.

COMPUTATION.

Of period of limitation, see Limitation of Actions, § 2.

CONCEALMENT.

Effect on limitation, see Limitation of Actions, § 2.
Of property by bankrupt with intent to defraud creditors as forfeiting right of exemption, see Bankruptcy, § 8.

CONCESSION.

By carriers, see Carriers, § 1.

CONCURRENT JURISDICTION.

Of courts, see Courts, § 3.

CONDEMNATION.

Taking property for public use, see Eminent Domain.

CONDITIONS.

Precedent to action for breach of contract, see Sales, § 3.

CONFLICT OF LAWS.

Conflicting jurisdiction of courts, see Courts, § 3.

CONSENT.

To reference, see Equity, § 5.

CONSPIRACY.

Combinations to monopolize trade, see Monopolies, § 1.

§ 1. Civil liability.

*A mere tacit understanding between conspirators to work to a common purpose is sufficient to constitute a guilty actionable combination.—In re Friedman (D. C.) 131.

§ 2. Criminal responsibility.

§ 43. An indictment under section 5440, Rev. St. (U. S. Comp. St. 1901, p. 3676), for conspiracy to defraud the United States, need not set forth the consummation of the fraud, nor allege that it could have been accomplished if not detected.—United States v. Stamatopoulos (C. C.) 524; Same v. Varnavelias, Id.

§ 43. An indictment for conspiracy to defraud by false invoice is not vitiated by the particularity with which the crime is set forth.—United States v. Stamatopoulos (C. C.) 524; Same v. Varnavelias, Id.

An agent of a railroad company, having authority to issue passes, indicted with others for a conspiracy to issue interstate free passes, to be, and which were, used in violation of Hepburn Act June 29, 1906, c. 3591, § 1, 34 Stat. 584 (U. S. Comp. St. Supp. 1907, p. 892), cannot defend on the ground that his principal had no knowledge of the fact, and therefore

*Point annotated. See syllabus.

committed no offense under the act.—United States v. Clark (D. C.) 75.

An indictment will lie, under Rev. St. § 5440 (U. S. Comp. St. 1901, p. 3676), for conspiracy to commit an offense in violation of Hepburn Act June 29, 1906, c. 3591, § 1, 34 Stat. 584 (U. S. Comp. St. Supp. 1907, p. 892), against an agent of a railroad company and others, to whom by agreement he issued interstate free passes, and who pursuant to such agreement sold the same for use in violation of said act.—United States v. Clark (D. C.) 75.

An indictment against a bankrupt and others for conspiracy to conceal property of the bankrupt from his trustee *held* not to state an offense under Rev. St. § 5440 (U. S. Comp. St. 1901, p. 3676).—United States v. Grodson (D. C.) 157.

CONSTITUTIONAL LAW.

Provisions relating to particular subjects.

See Bankruptcy, § 1; Canals, § 1; Commerce, §§ 1, 2; Courts, § 2; Judgment, § 5; Jury, § 1.

Enactment and validity of statutes, see Statutes, § 1.

Special or local laws, see Statutes, § 2.

§ 1. Distribution of governmental powers and functions.

§ 67. The power conferred on the Interstate Commerce Commission to make rates by section 15 of the interstate commerce act (Act Feb. 4, 1887, c. 104, 24 Stat. 384 [U. S. Comp. St. 1901, p. 3165], as amended by Act June 29, 1906, c. 3591, § 4, 34 Stat. 589 [U. S. Comp. St. Supp. 1907, p. 900]), is not judicial, and does not preclude a judicial inquiry into the justness and reasonableness of rates established.—Missouri, K. & T. R. Co. v. Interstate Commerce Commission (C. C.) 645.

§ 2. Due process of law.

The "commodities clause" of the interstate commerce act (Act Feb. 4, 1887, c. 104, 24 Stat. 379 [U. S. Comp. St. 1901, p. 3154]), as amended by Act June 29, 1906, c. 3591, § 4, 34 Stat. 584 (U. S. Comp. St. Supp. 1907, p. 894), is unconstitutional and void, as depriving persons of their liberty and property without due process of law, as applied to railroad companies which, by themselves or through subsidiary corporations, had for many years owned and operated coal lands and mines under the protection and encouragement of the laws of the state, and which mines could only be practically operated by shipping the product to other states over their own lines of road.—United States v. Delaware & H. Co. (C. C.) 215.

The power of Congress under the commerce clause of the Constitution to regulate interstate and foreign commerce is limited by the other provisions of the Constitution, and among them that of the fifth amendment, that no person shall be deprived of life, liberty, or property without due process of law; and the validity of a statute enacted in the assumed exercise of such power may be challenged on the ground

that it is in violation of such provision.—United States v. Delaware & H. Co. (C. C.) 215.

§ 298. Neither Congress nor any legislative or administrative board acting by its authorization can competently establish rates for the transportation of property in interstate commerce that will not admit of the carrier earning such compensation for the service rendered as under all the circumstances is just and reasonable.—Missouri, K. & T. R. Co. v. Interstate Commerce Commission (C. C.) 645.

§ 284. A tax statute is not invalid as depriving an owner of his property without due process of law where it provides for a general notice by publication, and fixes definite days for hearings as to the reasonableness of assessments made.—Jackson Lumber Co. v. McCrimmon (C. C.) 759.

§ 284. Laws Fla. 1907, p. 13, c. 5596, § 22, providing for the assessment for previous years of property which has escaped such taxation, is not invalid as depriving an owner of his property without due process of law, since section 23 (page 14) contains provision for notice and a hearing as to the reasonableness of the assessment by a board having power to change the same.—Jackson Lumber Co. v. McCrimmon (C. C.) 759.

CONTEMPT.

Disobedience to orders in bankruptcy proceedings, see Bankruptcy, §§ 1, 5.

CONTRACTS.

Alteration, see Alteration of Instruments.

Assignment, see Assignments.

Cancellation, see Cancellation of Instruments. Jurisdiction of admiralty in action on contract, see Admiralty, § 1.

Liquidated damages or penalties, see Damages, § 2.

Parol or extrinsic evidence, see Evidence, § 2.

Specific performance, see Specific Performance.

Contracts of particular classes of persons.

See Corporations, § 1; Master and Servant; Seamen.

Contracts relating to particular subjects.

See Patents, § 5.

Particular classes of express contracts.

See Bills and Notes; Insurance; Partnership; Sales.

Employment, see Master and Servant.

Sales of realty, see Vendor and Purchaser.

§ 1. Requisites and validity.

§ 10. A proposition to a contractor, having a contract for the construction of a specified building, to furnish him with all of the timber of a specified quality and dimension for that building, when accepted, constitutes a valid contract, binding the seller to furnish, and the contractor to buy thereunder, all of such timber required for the building, and not one to furnish merely such as the contractor may or

•Point annotated. See syllabus.

der, and therefore void for want of mutuality.—*Campfield v. Sauer* (C. C. A.) 833.

§ 2. Construction and operation.

§ 198. A contract for the construction of a sewer construed with respect to the compensation to which the contractor was entitled, where the quantities of rock and earth excavation varied from those stated in the contract.—*Gammino v. Inhabitants of Town of Dedham* (C. C. A.) 593.

§ 213. A provision, in a contract for making a sewer, subjecting the contractor to a penalty for delay in completing the work, held not to apply to delay due to a much larger quantity of rock excavation required than that estimated in the contract.—*Gammino v. Inhabitants of Town of Dedham* (C. C. A.) 593.

An obligation to pay for securities in such sums as might be required by the seller to carry out a contract referred to held not to give the obligor any interest in the purpose for which the money was used, which could constitute a defense to its liability.—*Joline v. Metropolitan Securities Co.* (C. C.) 144.

§ 3. Performance or breach.

§ 284. A provision in a sewer contract for a determination of disputes by the engineer does not deprive the parties of the right to a judicial construction of the contract, after completion of the work, with respect to the amount due the contractor.—*Gammino v. Inhabitants of Town of Dedham* (C. C. A.) 593.

§ 303. Matter set up by a defendant in an action for breach of contract to furnish tin cans to a cannery during the season held to constitute no defense.—*Pacific Sheet Metal Works v. Californian Canneries Co.* (C. C. A.) 980.

Under an obligation to pay the purchase money due for securities purchased as and when acquired by the seller on reasonable notice, a demand of a part and its absolute refusal was sufficient to support an action to recover the money due.—*Joline v. Metropolitan Securities Co.* (C. C.) 144.

§ 4. Actions for breach.

§ 335. The complaint in an action for breach of contract held not to state a cause of action, where it failed to allege performance by plaintiff of concurrent conditions of the contract, or to offer performance, as required by Civ. Code Cal. § 1439.—*Wilfley v. New Standard Concentrator Co.* (C. C. A.) 421.

CONTRIBUTORY NEGLIGENCE.

See Negligence, § 1.

Of passenger, see Carriers, § 4.

Of person injured by operation of railroad, see Railroads, § 2.

Of person injured by operation of street railroad, see Street Railroads, § 1.

Of servant, see Master and Servant, § 1.

CONVERSION.

Wrongful conversion of personal property, see Trover and Conversion.

CONVEYANCES.

In fraud of creditors, see Fraudulent Conveyances.

Particular classes of conveyances.

See Assignments; Chattel Mortgages; Mortgages.

COPYRIGHTS.

Jurisdiction of federal court in infringement suits, see Courts, § 1.

Jurisdiction of federal courts of action for infringement as dependent on diverse citizenship of parties, see Courts, § 2.

§ 1. Nature and acquisition.

A monogram cannot be copyrighted.—*Royal Sales Co. v. Gaynor* (C. C.) 207.

§ 2. Infringement.

§ 70. A writ of seizure issued in, or preliminary to, an action under Rev. St. § 4965 (U. S. Comp. St. 1901, p. 3414) to recover the penalty for infringement of a copyrighted publication is not strictly a writ of replevin and is not to be rendered inoperative by the technical provisions of a state statute.—*Richardson v. A. C. Bosselman & Co.* (C. C.) 781.

§ 70. A Circuit Court has authority under Rev. St. § 716 (U. S. Comp. St. 1901, p. 580) to issue a writ for the seizure of infringing copies of a copyright publication alleged to be in the possession of the infringer as preliminary to an action under Rev. St. § 4965 (U. S. Comp. St. 1901, p. 3414) to recover the penalty prescribed therein for each copy found in the possession of the defendant.—*Stern v. Jerome H. Remick & Co.* (C. C.) 781.

CORPORATIONS.

Authority of president of corporation to verify petition in involuntary bankruptcy, see Bankruptcy, § 1.

Bankruptcy proceedings against corporation as affected by proceedings for dissolution, see Bankruptcy, § 1.

Combinations in restraint of interstate commerce, see Monopolies, § 1.

Concurrent and conflicting jurisdiction of state and federal courts, see Courts, § 3.

Fraud of stockholders as amounting to fraudulent conveyance of corporate property, see Fraudulent Conveyances, § 1.

Injunctions affecting, see Injunction, § 2.

Jurisdiction of bankruptcy proceedings against, see Bankruptcy, § 1.

Jurisdiction of federal courts of actions against, see Courts, § 2.

Liability of stockholder for debts of bank, see Banks and Banking, § 1.

Restraining act of de facto officers, see Injunction, § 2.

Within meaning of bankruptcy law, see Bankruptcy, § 4.

Work on mining claim by stockholder as inuring to benefit of corporation, see Mines and Minerals, § 1.

*Point annotated. See syllabus.

Particular classes of corporations.

See Street Railroads.

Telegraph and telephone companies, see Telegraphs and Telephones.

§ 1. Corporate powers and liabilities.

§ 482. The failure of a trustee in a mortgage securing railroad bonds, in a suit to foreclose the mortgage, to contest the validity or amount of a prior mortgage, where legitimate grounds for such contest exist, may be grounds for permitting bondholders to intervene and make such contest.—Bowling Green Trust Co. v. Virginia Passenger & Power Co. (C. C.) 753.

§ 2. Dissolution and forfeiture of franchise.

§ 614. In the absence of a statute enlarging its powers, a court of equity has no jurisdiction at the suit of a stockholder or other private person to dissolve a corporation, nor to appoint a receiver to control the corporation, the effect of which will be to dissolve it, especially where the defendant is a foreign corporation, although doing business within the jurisdiction of the court.—Pearce v. Sutherland (C. C. A.) 609.

COSTS.

In bankruptcy, see Bankruptcy, § 10.
Payment on taking appeal, see Appeal and Error, § 2.

COUNTERCLAIM.

See Set-Off and Counterclaim.

COURTS.

Clerks, see Clerks of Courts.
Judicial power, see Constitutional Law, § 1.
Jurisdiction of proceedings affecting aliens, see Aliens, § 1.
Removal of action from state court to United States court, see Removal of Causes, § 1.
Review of acts of referee in bankruptcy, see Bankruptcy, § 5.
Review of decisions, see Appeal and Error.
Right to trial by jury, see Jury, § 1.
Trial by court without jury, see Trial, § 4.

§ 1. Nature, extent, and exercise of jurisdiction in general.

Where the jurisdiction of a federal court in a suit depends entirely upon the alleged infringement of a copyright, and the thing so alleged to be infringed is not within the copyright laws, no estoppel on the part of defendant to deny such fact can confer jurisdiction.—Royal Sales Co. v. Gaynor (C. C.) 207.

§ 2. United States courts.

A federal court is not bound to follow a decision of the highest court of a state construing a state statute, in a suit involving rights which had previously accrued.—Murray v. Wilson Distilling Co. (C. C. A.) 1.

Creditors of the State Dispensary of South Carolina held entitled to maintain a suit in

equity against the commission created to wind up its affairs, to enforce their claims against the fund in the hands of such commission as a trust fund.—Murray v. Wilson Distilling Co. (C. C. A.) 1.

*A suit in a federal court by creditors of the South Carolina State Dispensary Commission, created by Act Feb. 16, 1907 (Sess. Laws 1907, pp. 463, 835), held not one against the state, within the eleventh constitutional amendment.—Murray v. Wilson Distilling Co. (C. C. A.) 1.

A motion by the executrix of a person deceased to abate a judgment entered against him in a criminal action in his lifetime because of his death after it was entered is an independent proceeding of a civil nature, and the order or judgment therein may be reviewed on error by the United States.—United States v. New York Cent. & H. R. R. Co. (C. C. A.) 324.

§ 372. The question of the measure of damages recoverable in an action of tort, where not governed by the state Constitution or statutes, is one of general jurisprudence, upon which state decisions are not controlling on the federal courts.—Woldson v. Larson (C. C. A.) 548.

§ 405. The question of the jurisdiction of the Circuit Court, where it appears on the record on an appeal to the Circuit Court of Appeals, cannot be ignored, but must be determined by that court in disposing of the appeal, although not made a ground of appeal.—McGilvra v. Ross (C. C. A.) 604; Bressler v. Same, Id.

§ 282. Const. Wash. art. 17, § 1, which asserts the ownership by the state of the beds and shores of navigable waters, is not in violation of the federal Constitution, as depriving riparian owners under previous grants by the United States of their property without due process of law, and a suit by such owners to enjoin a sale of shore lands under a state statute does not involve any constitutional question, which gives a federal court jurisdiction.—McGilvra v. Ross (C. C. A.) 604; Bressler v. Same, Id.

§ 285. Patents issued by the United States under general laws to lands in a territory bordering on navigable waters do not convey by their own force title below high-water mark, but leave the question of the ownership and use of the shores to the sovereign control of the state when organized; and, the law having been so declared by the Supreme Court of the United States, a suit by grantees of such lands to enjoin a sale of adjoining shore lands by the state does not involve the construction of any law of the United States, which gives a federal court jurisdiction.—McGilvra v. Ross (C. C. A.) 604; Bressler v. Same, Id.

§ 356. Act July 20, 1892, c. 209, 27 Stat. 252 (U. S. Comp. St. 1901, p. 706), which allows the prosecution of an action in forma pauperis in a federal court, does not apply to appellate proceedings, and in the absence of a statute authorizing it the Circuit Court of Appeals has no authority to allow an appeal or writ of error in that form.—Taylor v. Adams Express Co. (C. C. A.) 616.

§ 356. Under the federal practice the opinion of a trial court cannot be referred to by an appellate court for the purpose of ascertaining the facts upon which the judgment was based, nor to control the formal findings made, although a reference thereto is incorporated in the bill of exceptions.—Pacific Sheet Metal Works v. Californian Canneries Co. (C. C. A.) 980.

§ 329. In an action between citizens of different states in the Circuit Court of the United States, where the complaint contains the requisite allegations as to the amount in controversy, jurisdiction is not defeated because other matters alleged tend to show that the allegation as to jurisdiction is not well founded, unless such fact is a certainty.—T. C. Henry & Sons & Co. v. Colorado Farm & Live Stock Co. (C. C. A.) 986.

A bill construed, and held not one by an assignee to recover the contents of a chose in action, within the meaning of section 629, Rev. St. (U. S. Comp. St. 1901, p. 503), which required complainant to show that it could have been maintained by the assignor, but one to enforce a trust ex maleficio, and within the jurisdiction of a federal court.—Prest-O-Lite Co. v. Avery Portable Lighting Co. (C. C.) 60.

*If to conform strictly to the state practice would unwisely incumber the administration of the law and tend to defeat the ends of justice in a given case, a federal court has power to reject the local rule of pleading as to subordinate matters of form, under Rev. St. § 914 (U. S. Comp. St. 1901, p. 684), which requires conformity to the state practice only "as near as may be."—Hein v. Westinghouse Air Brake Co. (C. C.) 79.

A federal court which has rendered a judgment in favor of a plaintiff in a suit within its jurisdiction has jurisdiction of a creditor's bill filed by the plaintiff to set aside fraudulent conveyances of property by defendant which prevent the collection of such judgment as ancillary to the first suit, without regard to the citizenship of the parties.—Hobbs Mfg. Co. v. Gooding (C. C.) 91.

A bill to restrain the infringement of a patent, which thus presents a federal question, does not draw within the jurisdiction of the Circuit Court a further issue as to unfair competition in trade, although it grows out of the same acts of defendant; the two causes of action being quite independent of each other.—Cushman v. Atlantis Fountain Pen Co. (C. C.) 94.

Where federal jurisdiction attaches at law, at the same time jurisdiction attaches for some purposes in equity, and vice versa.—Whelan v. Enterprise Transp. Co. (C. C.) 95.

Bill to enjoin infringement of alleged copyright dismissed for want of jurisdiction.—Royal Sales Co. v. Gaynor (C. C.) 207.

*Under section 1 of the federal judiciary act (Act March 3, 1875, c. 137, 18 Stat. 470), as amended by Act March 3, 1887, c. 373, 24 Stat. 552, and Act Aug. 13, 1888, c. 866, 25 Stat. 433 (U. S. Comp. St. 1901, p. 508), a suit against a railroad company based on the inter-

state commerce act, and within the jurisdiction of a federal court for that reason, can only be brought in the state in which the defendant is incorporated.—Memphis Cotton Oil Co. v. Illinois Cent. R. Co. (C. C.) 290.

§ 335. The commencement of a suit in equity in a federal court is not governed by the local statute for the commencement of actions in the state courts, but by the equity practice and procedure.—United States v. Miller (C. C.) 444; Same v. Robinson, Id.

§ 316. Where two persons, having separable, though similar, claims charged on real estate, joined in a bill to enforce the same, and the bill was amended by omitting one of them, that it might not fail for want of requisite diversity of citizenship, the circumstances did not disclose collusion, so as to render the amended bill demurrable.—Mathieson v. Craven (C. C.) 471.

§ 366. The rule that the construction of a state statute by the highest court of the state is conclusive on a federal court does not apply where a federal question is involved, as where a complainant contends that it acquired contract rights under such statute which are protected from impairment by the federal Constitution.—Sunset Telephone & Telegraph Co. v. City of Pomona (C. C.) 561.

§ 3. Concurrent and conflicting jurisdiction, and comity.

*The South Carolina State Dispensary Commission held not to be a court, within the meaning of Rev. St. § 720 (U. S. Comp. St. 1901, p. 581).—Murray v. Wilson Distilling Co. (C. C. A.) 1.

§ 500. A federal court is without jurisdiction to appoint receivers for property over which a state court has previously assumed jurisdiction in a similar suit therein by a mortgage creditor which is still pending.—Interstate Ry. Co. v. Philadelphia, B. & T. St. Ry. Co. (C. C.) 770.

§ 500. A complainant in a suit in rem in a state court has the right to appear without leave in a similar suit subsequently commenced in a federal court involving the same property for the special purpose of raising the question of such court's jurisdiction.—Interstate Ry. Co. v. Philadelphia, B. & T. St. Ry. Co. (C. C.) 770.

§ 524. Where a court of admiralty in a suit in rem acquired jurisdiction of the libeled vessel and the parties before the institution of bankruptcy proceedings against the owner in another district, and has sold the vessel and holds the proceeds, it can exercise its jurisdiction only so far as to determine the rights of the parties in admiralty, and any rights claimed under the bankruptcy law must be submitted to and determined by the court of bankruptcy having jurisdiction.—The William B. Kibbee (D. C.) 653.

COVERTURE.

See Husband and Wife.

*Point annotated. See syllabus.

CREDIBILITY.

Of witness, see Witnesses, § 1.

CREDITORS.

See Bankruptcy; Fraudulent Conveyances.

CRIMINAL LAW.

Bail, see Bail, § 1.

Civil or criminal nature of motion by executrix to abate judgment entered against decedent in criminal action as affecting appellate jurisdiction of circuit court of appeals, see Courts, § 2.

Extradition of persons accused, see Extradition.

Indictment, information, or complaint, see Indictment and Information.

Particular offenses.

See Conspiracy, § 2.

Offenses against customs laws, see Customs Duties, § 4.

Offenses against postal laws, see Post Office, § 2.

§ 1. Evidence.

§ 394. It is no objection to the admissibility of evidence which is pertinent to the issue in a criminal case that it was obtained by means of a search warrant illegally issued or executed.—*Hardesty v. United States* (C. C. A.) 420.

§ 398. Where the books of account of a bank were in court in a criminal case and subject to inspection by counsel, it was competent for a witness who was familiar therewith to summarize their contents in his testimony.—*Lemon v. United States* (C. C. A.) 953.

§ 419. An affidavit made to procure an attachment in an action against a bank held incompetent as evidence of the insolvency of the bank in a criminal case.—*Lemon v. United States* (C. C. A.) 953.

§ 419. An unauthenticated paper purporting to be a copy of a letter written by a third person held incompetent as evidence in a criminal case.—*Lemon v. United States* (C. C. A.) 953.

Regulations made by an executive department in pursuance of authority delegated by Congress have the force of law, and the courts take judicial notice of their existence and provisions, and it is unnecessary to set them out in an indictment for their violation, or to specify the particular rule violated.—*United States v. Moody* (D. C.) 269.

§ 2. Trial.

§ 661. While in the investigation of charges of fraud the latitude of inquiry is wider than is allowed in many other cases, it does not justify, in the admission of evidence, a disregard of the rules of competency or relevancy.—*Lemon v. United States* (C. C. A.) 953.

§ 3. Motions for new trial and in arrest.

§ 951. The setting aside of a verdict and granting of a new trial by a federal court in a criminal case is not governed by any statute, but is a matter of discretion, which may be exercised at any time before judgment has been entered on the verdict, although the term at which the verdict was returned may have passed.—*United States v. Rogers* (D. C.) 520.

§ 4. Judgment, sentence, and final commitment.

After the expiration of the term at which a judgment was rendered against a defendant in a criminal case the court has no power by an order to declare such judgment abated because of the subsequent death of the defendant.—*United States v. New York Cent. & H. R. R. Co.* (C. C. A.) 324.

§ 5. Appeal and error, and certiorari.

§ 1148. The consolidation of indictments for trial is a matter within the sound discretion of the trial court, which will not be interfered with by an appellate court, unless it has been abused or manifest injustice has been done.—*Lemon v. United States* (C. C. A.) 953.

CUBA.

Effect of registration of United States patent in Cuba during military occupancy by United States, see Patents, § 6.

Judicial notice of Cuban laws during military occupation by United States, see Evidence, § 1.

CUSTODY.

Of child, see Guardian and Ward, § 1.

CUSTOMS DUTIES.**§ 1. Validity, construction, and operation of customs laws in general.**

*The term "trimmings," in *Tariff Act July 24, 1897, c. 11, § 1, Schedule L, par. 390, 30 Stat. 187* (U. S. Comp. St. 1901, p. 1670), is used, not in its descriptive, but its commercial, sense.—*Naday & Fleischer v. United States* (C. C. A.) 44.

§ 2. Goods subject to duty, rate, and amount.

Under *Tariff Act July 24, 1897, c. 11, §§ 6 and 7, 30 Stat. 205* (U. S. Comp. St. 1901, p. 1693), which sections contain, respectively, the provision for unenumerated articles and the similitude clause, *held*, that the former does not apply where the latter is applicable.—*F. B. Vandegrift & Co. v. United States* (C. C.) 65.

Ramie sliver is not dutiable as an unenumerated manufactured article, under *Tariff Act July 24, 1897, c. 11, § 6, 30 Stat. 205* (U. S. Comp. St. 1901, p. 1693), but as cotton sliver by similitude, under section 1, *Schedule I, par. 302, 30 Stat. 175* (U. S. Comp. St. 1901, p. 1655).—*F. B. Vandegrift & Co. v. United States* (C. C.) 65.

*Point annotated. See syllabus.

Iron sand, a completely manufactured article, is dutiable as iron "manufactured," under Tariff Act July 24, 1897, c. 11, § 1, Schedule C, par. 193, 30 Stat. 167 (U. S. Comp. St. 1901, p. 1645), and not under paragraph 124, 30 Stat. 159 (U. S. Comp. St. 1901, p. 1636), relating to iron in "forms less finished than iron in bars, and more advanced than pig iron."—Harrison Supply Co. v. United States (C. C.) 155.

*"Unwrought" metals, enumerated in Tariff Act July 24, 1897, c. 11, § 1, Schedule C, par. 183, 30 Stat. 166 (U. S. Comp. St. 1901, p. 1645), do not include iron sand, a completely manufactured article.—Harrison Supply Co. v. United States (C. C.) 155.

*Granito or terrazo, produced from marble waste, is dutiable as an unenumerated manufactured article, under Tariff Act July 24, 1897, c. 11, § 6, 30 Stat. 205 (U. S. Comp. St. 1901, p. 1693), rather than as "waste," under section 1, Schedule N, par. 463, 30 Stat. 194 (U. S. Comp. St. 1901, p. 1679), or as minerals "crude," under section 2, Free List, par. 614, 30 Stat. 199 (U. S. Comp. St. 1901, p. 1685).—United States v. Graser-Rothe (C. C.) 205.

Under Tariff Act July 24, 1897, c. 11, § 1, Schedule J, par. 337, 30 Stat. 180 (U. S. Comp. St. 1901, p. 1662), plank linoleum is dutiable as "inlaid linoleum" rather than as "linoleum * * * figured or plain."—United States v. Scott & West (C. C.) 285.

§ 37. In Tariff Act July 24, 1897, c. 11, § 1, Schedule N, par. 439, 30 Stat. 192 (U. S. Comp. St. 1901, p. 1676), the provision that gloves shall be measured according to their "extreme length when stretched to their full extent," does not forbid disregarding slight accidental excesses over the lengths stated in the law.—United States v. Max Mayer & Co. (C. C.) 905.

§ 43. A liquid extract of the coffee bean held not dutiable as "articles used as coffee, or as substitutes for coffee," under Tariff Act July 24, 1897, c. 11, § 1, Schedule G, par. 283, 30 Stat. 172 (U. S. Comp. St. 1901, p. 1652), but as an unenumerated manufactured article under section 6, 30 Stat. 205 (U. S. Comp. St. 1901, p. 1693).—E. C. Hazard & Co. v. United States (C. C.) 907.

§ 30. Chutney is dutiable as "fruits preserved," under Tariff Act July 24, 1897, c. 11, § 1, Schedule G, par. 263, 30 Stat. 171 (U. S. Comp. St. 1901, p. 1651), rather than as "edible fruits * * * prepared," under paragraph 262.—Park & Tilford v. United States (C. C.) 910.

§ 30. The article commercially known as "chutney" does not, by reason of such designation, cease to be "fruits preserved," under Tariff Act July 24, 1897, c. 11, § 1, Schedule G, par. 263, 30 Stat. 171 (U. S. Comp. St. 1901, p. 1651).—Park & Tilford v. United States (C. C.) 910.

§ 35. Under Tariff Act July 24, 1897, c. 11, § 1, Schedule L, par. 336, 30 Stat. 186 (U. S. Comp. St. 1901, p. 1669), panne velvet is dutiable as "plush," rather than as "velvets."—United States v. Passavant & Co. (C. C.) 912.

§ 36. In printed post cards, ornamented with feathers, the printing is the chief feature, though the feathers are the element of chief value; and the cards are therefore dutiable as "printed matter," under Tariff Act July 24, 1897, c. 11, § 1, Schedule M, par. 403, 30 Stat. 189 (U. S. Comp. St. 1901, p. 1673).—A. H. Ringk & Co. v. United States (C. C.) 1021.

§ 3. Entry and appraisal of goods, bonds, and warehouses.

A protest, which, though imperfectly expressed, may be understood when read in connection with the statute it refers to, is sufficiently distinct and specific to satisfy the requirements of Customs Administrative Act June 10, 1890, c. 407, § 14, 26 Stat. 137 (U. S. Comp. St. 1901, p. 1933), and the fact that the collector understood the protest is relevant.—Lothrop v. United States (C. C.) 99.

§ 78. Where exact evidence as to the condition of an entire shipment of fruit was ascertainable, proof as to the condition of but 5 per cent. of the shipment is not applicable to the remaining 95 per cent.—Denunzio Fruit Co. v. United States (C. C.) 909.

§ 64. Customs Administrative Act June 10, 1890, c. 407, § 3, 26 Stat. 131 (U. S. Comp. St. 1901, p. 1887), providing for the indorsement on invoices of a declaration before a consul, does not require verification of the invoices.—United States v. 646 Half-Boxes of Figs (D. C.) 778; Same v. 82 Half-Boxes of Cheese, Id.

§ 4. Violations of customs laws.

§ 128. Customs Administrative Act June 10, 1890, c. 407, § 9, 26 Stat. 135 (U. S. Comp. St. 1901, p. 1895), relating to the illegal entry by the owner, etc., or "other person," does not refer to all individuals who might assist in the fraud, and would not include a customs weigher who made false reports.—United States v. Mescall (C. C.) 580.

§ 125. The fraudulent "entry" prohibited by Customs Administrative Act June 10, 1890, c. 407, § 9, 26 Stat. 135 (U. S. Comp. St. 1901, p. 1895), is not limited to the act of filing the document known as an "entry," but relates to the entire transaction of passing imports through the customhouse.—United States v. Mescall (C. C.) 580.

§ 128. Section 5444, Rev. St. (U. S. Comp. St. 1901, p. 3677), relating to the crime of illegally admitting imports to entry, does not refer merely to the act of filing the documentary entry at the custom house, but includes the whole process of passing the goods through the customs.—United States v. Mescall (C. C.) 584.

§ 128. Section 5444, Rev. St. (U. S. Comp. St. 1901, p. 3677), relating to aid in illegal importations, includes aid given after, as well as before, the fact.—United States v. Mescall (C. C.) 584.

§ 125. Section 5445, Rev. St. (U. S. Comp. St. 1901, p. 3678), relating to the illegal "entry" of imports, is not limited to proceedings connected with the filing of the paper technically known as an "entry."—United States v. Mescall (C. C.) 587.

*Point annotated. See syllabus.

§ 125. Section 5445, Rev. St. (U. S. Comp. St. 1901, p. 3678), relating to one who "effects, or aids in effecting," an illegal entry of imports, includes aid rendered after entry is made at the custom house.—United States v. Mescall (C. C.) 587.

§ 125. The penalty of section 5445, Rev. St. (U. S. Comp. St. 1901, p. 3678), for the illegal entry of imports, cannot be avoided on the theory that there would have been opportunity for repentance before the success of the fraud had been achieved.—United States v. Mescall (C. C.) 587.

§ 128. Section 5445, Rev. St. (U. S. Comp. St. 1901, p. 3678), relating to "every person" who aids in effecting the illegal entry of imports, may, while not ordinarily intended to do so, include customs officers, who come within the prohibition of the statute.—United States v. Mescall (C. C.) 587.

§ 125. Section 2865, Rev. St. (U. S. Comp. St. 1901, p. 1905), forbidding any person to "make out or pass, or attempt to pass, through the customhouse any false, forged, or fraudulent invoice," does not include a case in which it did not appear that the party charged had been concerned in importing the goods in question.—United States v. 646 Half-Boxes of Figs (D. C.) 778; Same v. 82 Half-Boxes of Cheese, Id.

§ 125. To make a fraudulent entry of merchandise at a customhouse is not to "smuggle or clandestinely introduce" merchandise, within the meaning of section 2865, Rev. St. (U. S. Comp. St. 1901, p. 1905).—United States v. 646 Half-Boxes of Figs (D. C.) 778; Same v. 82 Half-Boxes of Cheese, Id.

§ 130. Forfeiture for illegal entry under Customs Administrative Act June 10, 1890, c. 407, § 9, 26 Stat. 135 (U. S. Comp. St. 1901, p. 1895), does not accrue against a party who was abroad when the entry was made, where it did not appear that the person making the entry was his agent.—United States v. 646 Half-Boxes of Figs (D. C.) 778; Same v. 82 Half-Boxes of Cheese, Id.

§ 133. Exceptions to the sufficiency of an information for forfeiture should be sustained where no sufficient ground was stated or intended, though it might be inferred from the allegations made.—United States v. 646 Half-Boxes of Figs (D. C.) 778; Same v. 82 Half-Boxes of Cheese, Id.

DAMAGES.

Alienation of affections, see Husband and Wife, § 1.
Following state decisions in federal courts as to measure of damages in actions of tort, see Courts, § 2.

Damages for particular injuries.

See Death, § 1.

Breach by buyer of contract for sale of goods, see Sales, § 3.

Infringement of patent, see Patents, § 6.

§ 1. Grounds and subjects of compensatory damages.

§ 23. A plaintiff held entitled to recover for loss of profits as damages for breach of a contract.—Pacific Sheet Metal Works v. Californian Canneries Co. (C. C. A.) 980.

§ 2. Liquidated damages and penalties.

*A stipulation in an oil lease for the payment of a stated sum by the lessee as liquidated damages in case of his failure to drill a well within a specified time held valid and enforceable.—Blodget v. Columbia Live Stock Co. (C. C. A.) 305.

DEATH.

Caused by operation of railroad, see Railroads, § 2.

Liability of carrier for death of passenger, see Carriers, § 4.

§ 1. Evidence of death and of survivorship.

In an action on behalf of a minor to recover damages for the wrongful death of his mother, under a statute authorizing a recovery of such damages "as under all the circumstances of the case may be just," the recovery is not limited to the pecuniary loss suffered by the minor prior to his majority.—Butte Electric Ry. Co. v. Jones (C. C. A.) 308.

*Nonresident aliens are entitled to the benefit of Code Civ. Proc. Cal. § 377, giving a right of action for wrongful death.—Kaneko v. Atchison, T. & S. F. Ry. Co. (C. C.) 263.

DEBTOR AND CREDITOR.

See Bankruptcy; Fraudulent Conveyances.

DECEDENTS.

Estates, see Executors and Administrators.

DEEDS.

In fraud of creditors, see Fraudulent Conveyances.

Of trust, see Mortgages.

DELAY.

Laches, see Equity, § 1.

DELIVERY.

Of goods by carrier, see Carriers, § 2.

DEMAND.

For payment of bill or note, see Bills and Notes, § 2.

DEMURRAGE.

See Shipping, § 2.

*Point annotated. See syllabus.

DEMURRER.

In pleading, see Equity, § 3.

DESCENT AND DISTRIBUTION.

See Executors and Administrators.
War revenue taxes on legacies or distributive shares, see Internal Revenue.

DIRECTING VERDICT.

In civil actions, see Trial, § 2.

DISCHARGE.

From indebtedness, see Bankruptcy, § 8.

DISCRETION OF COURT.

Abuse of ground for collateral attack on judgment, see Judgment, § 3.
Ordering sale of property of railroad on foreclosure, see Railroads, § 1.

DISCRIMINATION.

By carrier, see Carriers, § 1.

DISEASES.

Exclusion of aliens because of, see Aliens, § 1.

DISMISSAL AND NONSUIT.

Dismissal of appeal in bankruptcy proceedings, see Bankruptcy, § 9.
Dismissal of suit in equity, see Equity, § 4.

DISSOLUTION.

Of corporation, see Corporations, § 2.
Of partnership, see Partnership, § 1.

DISTRIBUTION.

Of estate of bankrupt, see Bankruptcy, § 7.

DIVERSE CITIZENSHIP.

Ground of jurisdiction of United States courts, see Courts, § 2; Removal of Causes, § 3.

DIVORCE.

Admissibility of decree in action for alienation of affections, see Husband and Wife, § 1.

DOCKS.

See Wharves.

DOMICILE.

Residence as ground of jurisdiction, see Courts, § 2.

DUE PROCESS OF LAW.

See Constitutional Law, § 2.

DUTIES.

Customs duties, see Customs Duties.
Excise duties, see Internal Revenue.

EARTHQUAKES.

Liability under insurance policy for loss by, see Insurance, § 2.

ELECTIONS.

Of trustee in bankruptcy, see Bankruptcy, § 2.

EMBEZZLEMENT.

Extradition of person accused of, see Extradition, § 1.

EMINENT DOMAIN.

Act authorizing certain classes of cities to acquire waterworks property as special legislation, see Statutes, § 2.
Removal of cause to federal court, see Removal of Causes, §§ 3, 4.

§ 1. **Proceedings to take property and assess compensation.**

§ 194. Where a complaint in eminent domain in a county court in Colorado fails to state that the value of the property involved does not exceed the jurisdictional limitation of such court as required by 1 Mills' Ann. St. Colo. §§ 1054, 1055, the petition may be amended under section 1719.—Goodman v. City of Ft. Collins (C. C. A.) 970.

EMPLOYÉS.

See Master and Servant.

ENTICEMENT.

Of husband or wife, see Husband and Wife, § 1.

ENTRY.

Criminal responsibility for illegal entry of imports, see Customs Duties, § 4.
Of imported goods, see Customs Duties, § 3.
Of public lands, see Public Lands, § 1.

*Point annotated. See syllabus.

EQUITY.

Equitable set-off, see Set-Off and Counterclaim.
Equity jurisdiction of federal courts, see Courts, § 2.

Review of decree in equity as dependent on finality of determination, see Appeal and Error, § 1.

Particular subjects of equitable jurisdiction and equitable remedies.

See Cancellation of Instruments; Fraudulent Conveyances; Injunction; Receivers; Specific Performance.

Dissolution of corporation at suit of stockholder or other private person, see Corporations, § 2.

Suits for infringement of patents, see Patents, § 6.

§ 1. Laches and stale demands.

§ 87. If extraordinary circumstances make it inequitable to allow prosecution of a suit after a briefer, or to forbid its maintenance after a longer, period than that fixed by statute, the chancellor will determine the case in accordance with equity.—*Indiana & Arkansas Lumber & Mfg. Co. v. Brinkley* (C. C. A.) 963; *Deutsch v. Snowden*, Id.

§ 87. Mere increase in the value of property involved is not such an extraordinary circumstance as will authorize equity to depart from the analogous statute of limitations.—*Indiana & Arkansas Lumber & Mfg. Co. v. Brinkley* (C. C. A.) 963; *Deutsch v. Snowden*, Id.

§ 2. Parties and process.

§ 93. There is a distinction between necessary and indispensable parties, to ascertain whether some of those, who under the rules of equity pleading and practice were deemed necessary, may not be dispensed with as parties, that equitable relief in a given case may not wholly fail.—*Mathieson v. Craven* (C. C.) 471.

§ 93. Persons whose presence as parties is essential to the relief sought, and whose absence would render impossible any decree for such relief, are indispensable, in contradistinction to necessary, parties.—*Matheson v. Craven* (C. C.) 471.

§ 3. Pleading.

§ 219. A demurrer to a bill cannot be sustained on the ground that one against whom process is brought as a codefendant and whose presence is essential has not been served and has not appeared.—*Mathieson v. Craven* (C. C.) 471.

§ 150. A bill held demurrable for multifariousness.—*Groom v. Wittmann* (C. C.) 523.

§ 4. Dismissal before hearing.

§ 363. A motion to dismiss in an equity case, under Code Civ. Proc. Alaska, § 378 (Act June 5, 1900, c. 786, 31 Stat. 395), on the ground that the plaintiff has not made a prima facie case, admits every fact which the evidence proves or tends to prove, as well as the facts which may be reasonably inferred therefrom.—*Cook v. Klonos* (C. C. A.) 529.

§ 36. The fact that an appeal has been allowed, a supersedeas bond approved and filed, and a citation issued does not deprive the trial judge of power to thereafter settle and sign a bill of exceptions during the same term at which the decree appealed from was entered, where it was duly presented to him for settlement before the appeal was allowed.—*Cook v. Klonos* (C. C. A.) 529.

§ 5. Masters and commissioners, and proceedings before them.

§ 403. The consent of parties to a suit to a reference to a master to find the facts, which will render his finding on conflicting evidence unassailable, cannot be inferred from the mere failure to object to a general order of reference made before the suit was commenced.—*Guarantee Gold Bond Loan & Savings Co. v. Edwards* (C. C. A.) 809.

§ 409. The master's finding of facts cannot be impeached in the absence of a certificate or other proof that the evidence presented is the entire evidence, or that it was all the evidence which was before him relative to the specific finding challenged.—*Guarantee Gold Bond Loan & Savings Co. v. Edwards* (C. C. A.) 809.

§ 409. An order that the master should take and report the evidence, his report of it, and the legal presumption of his faithful discharge of official duty constitute competent proof that he had returned all the evidence before him.—*Guarantee Gold Bond Loan & Savings Co. v. Edwards* (C. C. A.) 809.

§ 410. The findings of a master as to the amount of damages recoverable by a complainant for infringement of a patent affirmed as against general exceptions which did not point out any evidence to impeach the same.—*H. C. Cook Co. v. Little River Mfg. Co.* (C. C.) 1005.

ERROR, WRIT OF.

See Appeal and Error.

ESTABLISHMENT.

Of telegraphs or telephones, see Telegraphs and Telephones, § 1.

ESTATES.

Decedents' estates, see Executors and Administrators.

ESTOPPEL.

By judgment, see Judgment, § 4.

EVIDENCE.

See Witnesses.

Applicability of instructions to evidence, see Trial, § 3.

Effect of admission of secondary evidence without objection, see Trial, § 1.

Questions of fact for jury, see Trial, § 2.

Reception at trial, see Criminal Law, § 2.

*Point annotated. See syllabus.

As to particular facts or issues.

See Judgment, § 6; Marriage.

Contributory negligence of person injured by operation of railroad, see Railroads, § 2.

Deed as mortgage, see Mortgages, § 1.

Infringement of trade-mark, see Trade-Marks and Trade-Names, § 2.

Preference by bankrupt, see Bankruptcy, § 4.

In actions by or against particular classes of persons.

See Master and Servant, § 2; Railroads, § 2.

In particular civil actions or proceedings.

For alienation of affections, see Husband and Wife, § 1.

For personal injuries, see Railroads, § 2.

Naturalization proceedings, see Aliens, § 3.

To cancel written instrument, see Cancellation of Instruments, § 1.

To quiet title to mining claim, see Mines and Minerals, § 1.

In Criminal Prosecutions.

See Criminal Law, § 1.

For offense against internal revenue laws, see Internal Revenue.

Review and procedure thereon in appellate courts.

See Appeal and Error, § 4.

Harmless error, see Appeal and Error, § 4.

Review as dependent on record on appeal or error, see Appeal and Error, § 3.

§ 1. Judicial notice.

A municipal ordinance is a municipal regulation, which must be pleaded, like any other fact of which judicial notice will not be taken.—*Robinson v. Denver City Tramway Co.* (C. C. A.) 174.

§ 37. Cuba, during the period of its military occupation by the United States, was not a part of the United States, but a foreign country, of whose laws an American court cannot take cognizance without plea and proof.—*Goodyear Tire & Rubber Co. v. Rubber Tire Wheel Co.* (C. C.) 869.

§ 43. In a plenary action in a Circuit Court by a trustee in bankruptcy the court cannot take judicial notice of matters of record in the District Court in the bankruptcy proceedings.—*McDonald v. Clearwater Shortline Ry. Co.* (C. C.) 1007.

§ 2. Parol or extrinsic evidence affecting writings.

§ 399. A contractor for the construction of a sewer was required at his peril to acquaint himself with the character of the ground to be excavated before signing the contract, and conversations between the parties in respect thereto which took place previously are not admissible to vary the written contract.—*Gammino v. Inhabitants of Town of Dedham* (C. C. A.) 593.

§ 399. Evidence of custom held inadmissible to affect the construction of a provision of a contract which was not ambiguous.—*Gammino v. Inhabitants of Town of Dedham* (C. C. A.) 593.

§ 398. The contract of service of a seaman as evidenced by the shipping articles cannot be changed by parol evidence unless fraud is clearly established.—*The Ucayali* (D. C.) 897.

§ 3. Weight and sufficiency.

If the positive evidence of an alleged fact is inherently improbable, the court is not bound to accept it as establishing such fact, but may reach a conclusion based upon circumstantial evidence which appears more convincing.—*In re Friedman* (D. C.) 131.

EXCEPTIONS.

Taking exceptions at trial, see Trial, § 1.

To master's report, see Equity, § 5.

To pleadings, see Equity, § 3.

EXCEPTIONS, BILL OF.

Necessity for purpose of review, see Appeal and Error, § 3.

EXCISE.

Duties, see Internal Revenue.

EXECUTION.

Finality for purpose of review of order refusing to quash an execution, see Appeal and Error, § 1.

Order staying proceeding pending disposition of judgment debtor's application for discharge in bankruptcy, see Bankruptcy, § 4.

EXECUTORS AND ADMINISTRATORS.

Civil or criminal nature of motion by executrix to abate judgment entered against decedent in criminal action as affecting appellate jurisdiction of circuit court of appeals, see Courts, § 2.

§ 1. Foreign and ancillary administration.

§ 521. There is no privity between the executors of a will of a decedent appointed in one state and an administrator with the will annexed in another state, nor between the administrators of the estate of an intestate appointed in different states.—*Wilson v. Hartford Fire Ins. Co.* (C. C. A.) 817.

§ 521. Estoppels in favor of or against executors or administrators in one state do not bind an administrator with the will annexed or an administrator of an intestate appointed in another state.—*Wilson v. Hartford Fire Ins. Co.* (C. C. A.) 817.

§ 521. Administration in the state of the domicile of the decedent does not govern the administration of the property of a decedent in any other state.—*Wilson v. Hartford Fire Ins. Co.* (C. C. A.) 817.

§ 521. A claim against a decedent's estate in the hands of the administrator with the will an-

*Point annotated. See syllabus.

nexed in one state is not barred because it was barred against the estate of decedent in the hands of the domiciliary executors in another state.—*Wilson v. Hartford Fire Ins. Co. (C. C. A.)* 817.

EXEMPLARY DAMAGES.

For alienation of affections, see *Husband and Wife*, § 1.

EXEMPTIONS.

Of bankrupt, see *Bankruptcy*, § 8.

EXPLOSIVES.

An explosion in the hold of a steamship when it was opened at the end of a voyage, and stevedores entered to discharge cargo, *held* on the evidence to have been caused by the vapor escaping from a shipment of "naphtha" soap, which, with the air, formed an explosive mixture.—*International Mercantile Marine Co. v. Fels (D. C.)* 337.

Shippers of a consignment of "fels naphtha" soap *held* not liable to the steamship company for damages resulting from an explosion caused by the vapor escaping from the soap during the voyage, where the company had notice of the character of the commodity, and that such a result might occur if it was not careful to stow the soap in a fully ventilated place, which it failed to do.—*International Mercantile Marine Co. v. Fels (D. C.)* 337.

EXTRADITION.

§ 1. International.

Evidence *held* insufficient to warrant the extradition of a person under Treaty with Italy March 23, 1868, art. 2, § 7 (15 Stat. 630), on a charge of embezzlement as a public officer.—*Ex parte Ronchi (D. C.)* 288.

§ 12. Under Rev. St. § 5270 (U. S. Comp. St. 1901, p. 3591), which provides generally for the issuance of a warrant in extradition proceedings on a complaint under oath, a certificate of the Secretary of State that application for the extradition of the person named has been made by the foreign government is not necessary to the issuance of such warrant, even where, as in case of Russia, the treaty provides for such certificate.—*In re Schlippenbach (D. C.)* 783.

FACTORS.

See *Brokers*.

FEDERAL COURTS.

See *Courts*, § 2.

FEDERAL QUESTIONS.

Ground for jurisdiction, see *Courts*, § 2.

FEES.

In bankruptcy, see *Bankruptcy*, § 10.
Payment on taking appeal, see *Appeal and Error*, § 2.

FINAL JUDGMENT.

Appealability, see *Appeal and Error*, § 1.

FINDINGS.

Of master in chancery, see *Equity*, § 5.
Review on appeal or writ of error, see *Appeal and Error*, § 4.

FIRE INSURANCE.

See *Insurance*, § 2.

FOOD.

Feeding of live stock by carrier, see *Carriers*, § 3.
Internal revenue laws as to manner of packing oleomargarine, prosecution for violation, see *Internal Revenue*.

FORECLOSURE.

Of lien, see *Railroads*, § 1.
Of mortgage, see *Railroads*, § 1.

FOREIGN ADMINISTRATION.

See *Executors and Administrators*, § 1.

FOREIGN JUDGMENTS.

See *Judgment*, § 5.

FORFEITURES.

For illegal entry of imports, see *Customs Duties*, § 4.
Of franchise, see *Corporations*, § 2.

FORGERY.

Liabilities of endorser of forged papers, see *Bills and Notes*, § 1.

FORMA PAUPERIS.

Proceedings on appeal or writ of error, in federal courts, see *Courts*, § 2.

FORMER ADJUDICATION.

See *Judgment*, § 4.

FORMS OF ACTION.

See *Trover and Conversion*.

*Point annotated. See *syllabus*.

FRANCHISES.

Forfeiture, see Corporations, § 2.

FRAUD.

See Fraudulent Conveyances.

Effect on limitation, see Limitation of Actions, § 2.

In entry of mining claim, see Mines and Minerals, § 1.

Relating to public lands, see Public Lands, § 1.

Remedies, see Cancellation of Instruments, § 1.

Use of mails to defraud, see Post Office, § 2.

FRAUDULENT CONVEYANCES.

By bankrupt, see Bankruptcy, § 4.

In action by trustee in bankruptcy, see Bankruptcy, § 6.

Jurisdiction of federal court of action to set aside, see Courts, § 2.

§ 1. **Transfers and transactions invalid.**

§ 32. A complainant, who relocated mining claims owned by a corporation at the instance of stockholders whose purpose was to defeat the collection of a judgment against the corporation, *held*, under Comp. Laws Nev. § 2708, which makes fraudulent conveyances void as against creditors, not entitled to relief in equity by a decree quieting his title as against a purchaser under the judgment.—*Wailles v. Davies* (C. C. A.) 397.

GARNISHMENT.

Of assigned property, see Assignments, § 1.

GAS.

Restraining enforcement of ordinance fixing price, including consumers in restraining order, see Injunction, § 3.

Restraining enforcement of ordinance fixing price of gas, see Injunction, § 3.

Restraining enforcement of ordinance fixing price, payment into court of amount collected in excess of ordinance rate, see Injunction, § 3.

GRAND JURY.

See Indictment and Information.

GRANTS.

Of public lands, see Public Lands.

GUARDIAN AND WARD.

§ 1. **Custody and care of ward's person and estate.**

§ 53. Under the law of Oregon, in force in Alaska prior to the enactment of the Alaska

Code, which empowered a probate court to make an order authorizing the investment of funds by a guardian "after notice to all other persons interested," an order without such notice affords a guardian no protection.—*Corcoran v. Kostrometinoff* (C. C. A.) 685.

§ 55. A guardian is permitted to leave the funds of his ward temporarily on deposit in a reputable bank, pending investment or other disposition of the same; but he is personally liable for a loss of funds deposited with a bank for a fixed period of time on a certificate of deposit without security.—*Corcoran v. Kostrometinoff* (C. C. A.) 685.

§ 56. While a mere error of judgment will not subject a guardian to personal liability for the loss of his ward's funds, he is nevertheless held to the exercise of prudence and sound discretion in investing the same, and if he loans his ward's money without security he assumes the entire risk, no matter what may have been the credit of the borrower.—*Corcoran v. Kostrometinoff* (C. C. A.) 685.

HABEAS CORPUS.

§ 1. **Jurisdiction, proceedings, and relief.**

Where because of infancy, incompetency, or lack of time a petition for a writ of habeas corpus in a deportation case cannot be verified by the applicant as required by Rev. St. § 754 (U. S. Comp. St. 1901, p. 593), it may be verified by his attorney.—*United States v. Watchorn* (C. C.) 152.

§ 45. A federal prisoner at large on bail *held* not entitled to discharge on habeas corpus from the custody of state authorities, by whom he was arrested and held to answer to an indictment in a state court, where neither the United States nor his surety asked his discharge.—*Ex parte Marrin* (D. C.) 631.

HARMLESS ERROR.

In civil actions, see Appeal and Error, § 4.

HEARSAY.

In criminal prosecutions, see Criminal Law, § 1.

HIGHWAYS.

Accidents at railroad crossings, see Railroads, § 2.

Right to use of by telegraph or telephone company, see Telegraphs and Telephones, § 1.

HOMESTEAD.

Entry on public land granted to railroad, see Public Lands, § 1.

In public lands, see Public Lands, § 1.

*Point annotated. See syllabus.

HUSBAND AND WIFE.

See Marriage.

Right of alien woman married to an alien to naturalization, see Aliens, § 3.

§ 1. Enticing and alienating.

§ 326. A husband is not precluded from recovering damages for the debauching of his wife by the fact that he saw her meet defendant at night, and might have prevented the injury complained of, unless he connived at it.—Woldson v. Larson (C. C. A.) 548.

§ 333. In an action for alienating the affections of plaintiff's wife and debauching her, a decree of divorce obtained by plaintiff since the acts complained of is admissible in evidence for the purpose of showing a severance of the relations between him and his wife.—Woldson v. Larson (C. C. A.) 548.

§ 334. It is a settled rule of the common law as administered by the federal courts that in an action for a tort, such as the alienation of the affections of the plaintiff's wife, exemplary damages are recoverable.—Woldson v. Larson (C. C. A.) 548.

§ 335. An instruction in an action for debauching plaintiff's wife held to correctly and sufficiently define the word "connivance," as applied to the facts in evidence.—Woldson v. Larson (C. C. A.) 548.

IMMIGRATION.

Regulation, see Aliens, §§ 1, 2.

IMPEACHMENT.

Of witness, see Witnesses, § 1.

IMPORTS.

Duties, see Customs Duties.

IMPRISONMENT.

See Bail.

Habeas corpus, see Habeas Corpus.

INDIANS.

§ 15. The land granted to the Choctaw Nation March 23, 1842, pursuant to treaty of September 27, 1830 (7 Stat. 333), in which also the Chickasaw Nation obtained an interest in common with the Choctaws by the treaty between them made January 17, 1837 (11 Stat. 573) became tribal property and its disposition subject to the control of Congress whose action in that regard by Act April 26, 1906, c. 1875, 34 Stat. 137 (U. S. Comp. St. Supp. 1907, p. 867) providing for such disposition based on an enrollment of the tribes to be completed and approved by March 4, 1907, is conclusive on the

courts which have no power to revise such enrollment.—Ligon v. Johnston (C. C. A.) 670.

INDICTMENT AND INFORMATION.

Against particular classes of persons.

Masters of vessel, see Aliens, § 1.

For particular offenses.

See Conspiracy, § 2.

Use of mails to defraud, see Post Office, § 2.

Violations of Chinese exclusion laws, see Aliens, § 1.

Violations of internal revenue regulations, see Internal Revenue.

§ 1. Requisites and sufficiency of accusation.

§ 110. An indictment under Rev. St. § 5480, as amended by Act March 2, 1889, c. 393, 25 Stat. 873 (U. S. Comp. St. 1901, p. 3696), for using the mails to defraud, need not follow the language of the statute, but it is sufficient if the averments bring the charge within the substance and true meaning of the statute—Lemon v. United States (C. C. A.) 953.

*Regulations made by an executive department in pursuance of authority delegated by Congress have the force of law, and the courts take judicial notice of their existence and provisions, and it is unnecessary to set them out in an indictment for their violation, or to specify the particular rule violated.—United States v. Moody (D. C.) 269.

§ 2. Motion to quash or dismiss, and demurrer.

Surplusage in an indictment is not ground for quashing the same, in whole or in part.—United States v. Moody (D. C.) 269.

§ 3. Waiver of defects and objections, and ailer by verdict.

§ 196. The objection that an indictment is bad for duplicity must be taken by a motion to quash, demurrer, or motion to require an election, and is waived by going to trial without objection.—Lemon v. United States (C. C. A.) 953.

INDORSEMENT.

Of bill of exchange or promissory note, see Bills and Notes, § 1.

INFANTS.

See Guardian and Ward.

Elements of damages for death of parent, see Death, § 1.

Naturalization of minor aliens, see Aliens, § 3.

INFORMATION.

Criminal accusation, see Indictment and Information.

For forfeiture under customs laws, see Customs Duties, § 4.

*Point annotated. See syllabus.

INFRINGEMENT.

Of copyright, see Copyrights, § 2.
 Of patent, see Patents, § 6.
 Of trade-mark, see Trade-Marks and Trade-Names, § 2.

INHERITANCE TAX.

War revenue taxes, see Internal Revenue.

INJUNCTION.

Relief against particular acts or proceedings.

Collection of tax, see Taxation, § 4.
 Infringement of patent, see Patents, § 6.
 Infringement of trade-name, see Trade-Marks and Trade-Names, § 2.
 Maintenance of wharf, see Navigable Waters, § 1.

§ 1. Nature and grounds in general.

§ 23. Where it is sought to enjoin a lawful business, the court should give due consideration to the comparative injury which will result from the granting or refusal of the injunction sought.—*McCarthy v. Bunker Hill & Sullivan Mining & Concentrating Co. (C. C. A.) 927.*

§ 24. A permanent injunction held properly refused, where it would result in stopping large mining operations in which thousands of men were employed and large capital invested, because of a comparatively small amount of damage resulting from the use of the waters of a stream to farms below, for which actions at law for damages were pending.—*McCarthy v. Bunker Hill & Sullivan Mining & Concentrating Co. (C. C. A.) 927.*

§ 2. Subjects of protection and relief.

Equity has jurisdiction of a suit to enjoin injury to the business of a manufacturer by circulating statements that his product is an infringement of patents against him and his customers, in bad faith, for the sole purpose of injuring his trade, and without intention to bring such suits.—*Dittgen v. Racine Paper Goods Co. (C. C.) 84.*

*The action of a defendant in threatening suits for infringement of patents against complainant and his customers, which suits it refused to bring when invited by complainant, held to constitute unfair competition, which entitled complainant to relief in equity by an injunction and accounting.—*Dittgen v. Racine Paper Goods Co. (C. C.) 85.*

§ 49. Including the land of another in a reservoir basin and flooding the same constitutes a permanent obstruction to its use by the owner, which entitles him to an injunction.—*United States v. Rickey Land & Cattle Co. (C. C.) 496.*

§ 69. A United States court having jurisdiction will enjoin de facto or de jure officers of a corporation from perpetrating or permitting violations of law to the injury of innocent stockholders, who have had no adequate remedy at law and are unable to induce the corporation

to protect them.—*Morrell v. Geo. Brooks & Son Co. (C. C.) 501.*

§ 3. Preliminary and interlocutory injunctions.

§ 138. In a suit by a gas company against a city and its officers to restrain the enforcement of an ordinance fixing the price of gas to be charged to consumers as unconstitutional, the defendants represent the consumers and a temporary restraining order may properly be made to apply to all consumers although not parties to the record where otherwise each might bring an action against complainant for failure to obey the ordinance.—*San Francisco Gas & Electric Co. v. City and County of San Francisco (C. C.) 884.*

§ 149. A temporary order restraining the enforcement of an ordinance fixing the price of gas until a hearing as to its validity may properly require the complainant gas company to pay into court all sums collected in excess of the ordinance rate to await the final determination of the case.—*San Francisco Gas & Electric Co. v. City and County of San Francisco (C. C.) 884.*

INSOLVENCY.

See Bankruptcy.

INSTRUCTIONS.

In civil actions, see Trial, § 3.

INSURANCE.

Admiralty jurisdiction in action on contract with marine insurance company, see Admiralty, § 1.

Rights of trustee of bankrupt as to life policy held by bankrupt, see Bankruptcy, § 3.

§ 1. The contract in general.

§ 146. Words used in a policy of insurance should be given their common, ordinary meaning, rather than that of the lexicographers or of those skilled in the niceties of language.—*Williamsburgh City Fire Ins. Co. of Brooklyn v. Willard (C. C. A.) 404.*

§ 2. Risks and causes of loss.

§ 421. A provision of a fire policy exempting the insurer from liability for loss "occasioned by or through earthquake" construed.—*Williamsburgh City Fire Ins. Co. of Brooklyn v. Willard (C. C. A.) 404.*

§ 421. An insurer against loss by fire held not exempt from liability for a loss, under the terms of the policy, by virtue of Civ. Code Cal. § 2628.—*Williamsburgh City Fire Ins. Co. of Brooklyn v. Willard (C. C. A.) 404.*

INTERLOCUTORY INJUNCTION.

See Injunction, § 3.

*Point annotated. See syllabus.

INTERLOCUTORY JUDGMENT.

Appealability, see Appeal and Error, § 1.

INTERNAL REVENUE.

Under War Revenue Act June 13, 1898, c. 448, § 29, 30 Stat. 464 (U. S. Comp. St. 1901, p. 2307), and Act June 27, 1902, c. 1160, § 3, 32 Stat. 406 (U. S. Comp. St. Supp. 1907, p. 652), the interest of a legatee who shares in the net income of the residuary estate of a testator, left in trust until the time fixed for its distribution, which is subject to legacy tax, is limited to the amount actually received by him prior to July 1, 1902.—*Lynch v. Union Trust Co. of San Francisco* (C. C. A.) 161.

The terms "actual value," as used in section 29, and "clear value," in section 30, War Revenue Act June 13, 1898, c. 448, 30 Stat. 464, 465 (U. S. Comp. St. 1901, pp. 2307, 2308), defined.—*Lynch v. Union Trust Co. of San Francisco* (C. C. A.) 161.

§ 8. War Revenue Act June 13, 1898, c. 448, §§ 29, 30, 30 Stat. 464, 465 as amended by Act March 2, 1901, c. 806, §§ 10, 11, 31 Stat. 946, 948 (U. S. Comp. St. 1901, pp. 2307, 2308), the repealing act of April 12, 1902, c. 500, §§ 7, 8, 32 Stat. 97 (U. S. Comp. St. Supp. 1907, p. 649), and Act June 27, 1902, c. 1160, § 3, 32 Stat. 406 (U. S. Comp. St. Supp. 1907, p. 652), all relating to legacy taxes, construed, and a legacy *held* to have become vested in enjoyment so as to be taxable thereunder.—*Westhus v. Union Trust Co. of St. Louis* (C. C. A.) 795.

§ 8. A will construed and the interests of the children of the testator in the residuary estate left in trust in the income from which they shared, with the right to dispose of their shares of the corpus by deed or will, *held* to be vested in enjoyment and subject to legacy tax, under War Revenue Act June 13, 1898, c. 448, § 29, 30 Stat. 464 (U. S. Comp. St. 1901, p. 2307), and not under Act June 27, 1902, c. 1160, § 3, 32 Stat. 406 (U. S. Comp. St. Supp. 1907, p. 652).—*Title Guarantee & Trust Co. v. Ward* (C. C.) 459.

§ 8. The interest of the children of a testator in a portion of his residuary estate left in trust and directed to be set apart and the income paid to the widow during her lifetime *held* not to have vested until her death, so as to become subject to tax under War Revenue Act June 13, 1898, c. 448, § 29, 30 Stat. 464 (U. S. Comp. St. 1901, p. 2307).—*Title Guarantee & Trust Co. v. Ward* (C. C.) 459.

§ 47. Evidence *held* insufficient to sustain a conviction for a violation of Rev. St. § 3324 (U. S. Comp. St. p. 2168), for a failure to remove the stamp from a barrel containing spirits when emptied.—*United States v. Rogers* (D. C.) 520.

§ 47. An indictment for violation of section 6 of the Oleomargarine Act of August 2, 1836, c. 840, 24 Stat. 210 (U. S. Comp. St. 1901, p. 2230), *held* insufficient as too indefinite and uncertain in describing the offense.—*United States v. Lockwood* (D. C.) 772.

INTERNATIONAL LAW.

See Aliens; Extradition, § 1.

INTERSTATE COMMERCE.

Regulation, see Carriers, § 1; Commerce.

INTERSTATE COMMERCE COMMISSION.

Regulation of carriers, see Carriers, § 1.

INTERVENTION.

By mortgage bond holders in suit by trustee to foreclose corporate mortgage, see Corporations, § 1.

INVENTION.

See Patents.

INVESTMENT.

By guardian, see Guardian and Ward, § 1.

INVOICE.

Of imported goods, see Customs Duties, § 3.

JUDGES.

See Courts.

Mandamus against judge, liability for costs, see Mandamus, § 1.

JUDGMENT.

Review, see Appeal and Error.

Civil or criminal nature of motion by executrix to abate judgment entered against decedent in criminal action as affecting appellate jurisdiction of circuit court of appeals, see Courts, § 2.

In action for infringement of patent, see Patents, § 6.

In criminal prosecutions, see Criminal Law, § 4.

Order staying proceedings pending disposition of judgment debtor's application for discharge in bankruptcy, see Bankruptcy, § 4.

§ 1. Nature and essentials in general.

§ 17. A decree against heirs of a decedent, without giving their names in the complaint or warning order, *held* void.—*Indiana & Arkansas Lumber & Mfg. Co. v. Brinkley* (C. C. A.) 963; *Deutsch v. Snowden*, Id.

§ 2. On trial of issues.

§ 251. A valid judgment must accord with the pleadings and rest on a determination of the issues which they present.—*Wagoner Nat. Bank v. Welch* (C. C. A.) 813.

*Point annotated. See syllabus.

§ 251. A judgment against a party to an action for the value of specific personal property may not be sustained on pleadings which raise no issue as to its value and contain no prayer for a recovery.—*Wagoner Nat. Bank v. Welch* (C. C. A.) 813.

§ 3. Collateral attack.

§ 489. When the record is silent regarding alleged defects, there is no room for presumption of regularity, and the decree is void on collateral attack when the record discloses lack of jurisdiction.—*Indiana & Arkansas Lumber & Mfg. Co. v. Brinkley* (C. C. A.) 963; *Deutsch v. Snowden*, Id.

§ 503. A judgment is not open to collateral attack because there may have been an abuse of discretion in the exercise of a lawful power to allow amendments to the complaint.—*Goodman v. City of Ft. Collins* (C. C. A.) 970.

§ 4. Merger and bar of causes of action and defenses.

In a suit for infringement of a patent, the question of priority of invention is not res judicata because of a decision in favor of the patent in interference proceedings in the Patent Office between the same parties.—*Davis & Roesch Temperature Controlling Co. v. National Steam Specialty Co.* (C. C.) 191.

§ 5. Foreign judgments.

*Neither the constitutional provision that full faith and credit shall be given in each state to the public acts, records, and judicial proceedings of every other state, nor the act of Congress passed in pursuance thereof, prevents an inquiry into the jurisdiction of the court by which a judgment offered in evidence was rendered; and the record of such judgment may be contradicted as to the facts necessary to give the court jurisdiction either as to the subject-matter or the person.—*Davis v. Davis* (C. C.) 281.

Under the law of Pennsylvania which authorizes the entry of a personal judgment without notice on a judgment note, a judgment so entered on a Pennsylvania contract must be accepted by a court in another state as one rendered by a court having jurisdiction.—*Davis v. Davis* (C. C.) 281.

Under Act Pa. April 3, 1903 (P. L. 139), and the Pennsylvania practice, a writ of scire facias to revive a personal judgment is a continuation of the original suit, and the court has power to enter a judgment of revival on the return of two such writs nihil habet; but under Act March 26, 1827 (P. L. 129), and Act June 1, 1887 (P. L. 289), such revival must be within five years from the date of the original judgment, and a judgment of revival entered on such return of writs issued after the expiration of that time is void for want of jurisdiction and will not support an action in another state.—*Davis v. Davis* (C. C.) 281.

§ 6. Pleading and evidence of judgment as estoppel or defense.

§ 949. Where a decree dismissing a bill does not disclose the ground of dismissal, the presumption is that it was on the merits; but such presumption is not conclusive, and, when such

decree is pleaded in bar of a subsequent action, the plaintiff may by his replication plead facts showing that it was not in fact on the merits.—*Stratton v. Essex County Park Commission* (C. C.) 901.

JUDICIAL NOTICE.

In civil actions, see Evidence, § 1.
In criminal prosecutions, see Criminal Law, § 1.

JUDICIAL POWER.

See Constitutional Law, § 1.

JUDICIAL SALES.

Limitation of actions, see Limitation of Actions, § 1.

JURISDICTION.

Want of jurisdiction ground for collateral attack on judgment, see Judgment, § 3.

Jurisdiction of particular actions or proceedings.

See Habeas Corpus, § 1.

By or against trustee in bankruptcy, see Bankruptcy, § 6.

Special jurisdictions and jurisdictions of particular classes of courts.

See Admiralty, § 1; Bankruptcy, § 1.

Particular courts, see Courts.

JURY.

Instructions in civil actions, see Trial, § 3.
Questions for jury in civil actions, see Trial, § 2.

Taking case or question from jury at trial, see Trial, § 2.

§ 1. Right to trial by jury.

That defendant filed a claim against an estate in the hands of a receiver did not constitute a waiver of his right to a jury trial in a suit brought by the receiver against claimant, not by way of set-off, but to recover a money demand.—*Whelan v. Enterprise Transp. Co.* (C. C.) 95.

KNOWLEDGE.

Affecting or element of contributory negligence, see Negligence, § 1.

Effect of ignorance of cause of action on limitation, see Limitation of Actions, § 2.

LACHES.

Effect in equity, see Equity, § 1.

*Point annotated. See syllabus.

LANDLORD AND TENANT.

Lease of wharf, see Wharves.
Priority of claim for rent as against bankrupt's estate, see Bankruptcy, § 7.
Rent as provable claim against estate of bankrupt, see Bankruptcy, § 7.

LANDS.

See Public Lands.
Of indian tribes, see Indians.

LEGACY TAX.

War revenue taxes, see Internal Revenue.

LETTERS PATENT.

For inventions, see Patents.

LICENSES.

For making, use, or sale of patented articles, see Patents, § 5.

LIENS.

Effect of proceedings in bankruptcy, see Bankruptcy, § 4.
Pledge, see Pledges.
Railroad liens, see Railroads, § 1.
Tax liens, see Taxation, § 3.

LIMITATION.

Of claim of patent, see Patents, § 4.

LIMITATION OF ACTIONS.

See Adverse Possession.
Action to redeem from mortgage, see Mortgages, § 2.
Laches, see Equity, § 1.

§ 1. Statutes of limitation.

A suit to recover land sold under foreclosure sale *held* barred by limitation, under Rev. St. Mo. 1899, § 4262 (Ann. St. 1906, p. 2335).—Clapp v. Leavens (C. C. A.) 318.

Rev. St. Mo. 1899, § 4262 (Ann. St. 1906, p. 2335), which limits the time within which an action may be brought for the recovery of lands to 10 years, and which under the decisions of the state Supreme Court applies to all suits, whether legal or equitable, may be invoked in a federal court by a purchaser in possession under a deed executed on a foreclosure sale in a suit by the mortgagor to redeem, where the possession of the defendant was adverse.—Clapp v. Leavens (C. C. A.) 318.

§ 19. Kirby's Dig. Ark. § 5060, limiting the time for suits against purchasers at judicial sales, is inapplicable where the court which ordered the sales never acquired any jurisdiction

to make them.—Indiana & Arkansas Lumber & Mfg. Co. v. Brinkley (C. C. A.) 963; Deutsch v. Snowden, Id.

§ 2. Computation of period of limitation.

The mere ignorance of a plaintiff of his cause of action will not prevent the running of the statute of limitations, but there must have been some concealment of facts which ordinary diligence could not discover.—Clapp v. Leavens (C. C. A.) 318.

*An amendment of a bill which does not introduce a new cause of action relates back to the filing of the bill for the purpose of the statute of limitations.—Dittgen v. Racine Paper Goods Co. (C. C.) 85.

§ 118. To constitute the commencement of a suit in equity in a federal court, which will stop the running of the statute of limitations, there must be the filing of a bill and the due issuance of a writ of subpoena, which must come to the hands of the serving officer with intent that it be served, and there must be a bona fide attempt to serve it, followed, if unsuccessful, by reasonable diligence to procure service through further or additional process.—United States v. Miller (C. C.) 444; Same v. Robinson, Id.

§ 119. The filing of a bill in equity and the issuance of a subpoena thereon, which the marshal attempted in good faith to serve, *held* to constitute the commencement of the suit, for the purpose of arresting the running of the statute of limitations.—United States v. Miller (C. C.) 444; Same v. Robinson, Id.

LIQUIDATED DAMAGES.

See Damages, § 2.

LITERARY PROPERTY.

See Copyrights.

LITTORAL RIGHTS.

See Navigable Waters, § 1.

LIVE STOCK.

Carriage of, see Carriers, § 3.

LOCAL LAWS.

See Statutes, § 2.

LOCATION.

Of mining claim, see Mines and Minerals, § 1.

MAIL.

See Post Office, § 1.

*Point annotated. See syllabus.

MANDAMUS.**§ 1. Jurisdiction, proceedings, and relief.**

§ 190. There is no federal statute nor rule of the Supreme Court giving costs to the prevailing party on a mere order to show cause issued on a petition for a writ of mandamus; and the question of costs in such case is therefore governed by the principles which apply to a bill in equity.—*In re Haight & Freese Co.* (C. C. A.) 688.

§ 190. On a petition for a writ of mandamus against a judge, where the adverse parties appear and move to dismiss because the order complained of has been vacated, which motion is granted, costs will not be allowed to either party.—*In re Haight & Freese Co.* (C. C. A.) 688.

MANDATE.

See Mandamus.

MARRIAGE.

See Husband and Wife.

§ 50. A marriage may be proved by the testimony of one of the parties that they were married by a priest and proof that they lived together as husband and wife for a number of years.—*Woldson v. Larson* (C. C. A.) 548.

MARRIED WOMEN.

See Husband and Wife.

MASTER AND SERVANT.

By seamen, see Seamen.
Excluding or ignoring issue, defenses, or evidence, see Trial, § 3.

Interstate commerce regulations as to safety appliances used by railroads, see Commerce, § 2.

Liability of mining partnership for wages of employé on change of membership in firm, see Mines and Minerals, § 2.

Parol or extrinsic evidence to vary terms of contract of employment, see Evidence, § 2.

Right of seamen to wages, see Seamen.

Validity of fellow servant law, see Statutes, § 1.

Wages as preferred claim against bankrupt's estate, see Bankruptcy, § 7.

§ 1. Master's liability for injuries to servant.

*An employé of a mining company engaged in stripping the ore bed, who walked along a track over which trains were being run to a dump at frequent intervals, and was struck and injured by such a train, which he could have seen approaching for a distance of 400 feet, but failed to look after going upon the track, held guilty of contributory negligence which precluded his recovery for the injury.—*Republic Iron & Steel Co. v. Tobin* (C. C. A.) 38.

*The duty of so using a reasonably safe place, of so operating reasonably safe machinery, and of so conforming to a reasonably safe method of work, that injury will not result, is no part of the positive duty of the master.—*Portland Gold Min. Co. v. Duke* (C. C. A.) 180.

§ 193. An employé of a railroad company does not by virtue of his contract of service assume the risk of injury from the negligence of the servants of another company jointly using the tracks of his employer, but has the same right of action against such company for an injury so occurring as any stranger.—*Hamble v. Atchison, T. & S. F. Ry. Co.* (C. C. A.) 410.

§ 205. The law imposes upon a mine owner the duty of exercising reasonable care to see that the mine is in a reasonably safe condition for an employé to work therein and does not require the employé to exercise care to discover its condition before going to his work.—*Bolen-Darnall Coal Co. v. Williams* (C. C. A.) 665.

§ 87. The provisions of Act April 22, 1908, c. 149, 35 Stat. 65, relating to the liability of common carriers by railroad to their employés, are prospective only in their operation, and do not apply to an action by an employé for an injury received before the statute was enacted.—*Winfree v. Northern Pac. Ry. Co.* (C. C.) 698.

§ 2. Liabilities for injuries to third persons.

In an action against an employer, where the sole charge is that an employé was negligent on a particular occasion, it is irrelevant to prove that he, or some other employé, had been negligent on other occasions.—*Robinson v. Denver City Tramway Co.* (C. C. A.) 174.

MASTERS IN CHANCERY.

See Equity, § 5.

MATERIALITY.

Of alteration of written instrument, see Alteration of Instruments.

Of evidence in criminal prosecutions, see Criminal Law, § 1.

MINES AND MINERALS.

Applicability of instructions to case in action for injury to miner, see Trial, § 3.

Liquidated damages for breach of oil and gas lease, see Damages, § 2.

Mine operators as employers, see Master and Servant, § 1.

Relocation as constituting fraud on creditors, see Fraudulent Conveyances, § 1.

Restraining operation of mine, see Injunction, § 1.

Sale of coal, see Sales, § 1.

Specific performance of contract conveying mineral, see Specific Performance, § 1.

§ 1. Public mineral lands.

§ 23. A stockholder in a mining company has such a beneficial interest in the corporate prop-

*Point annotated. See syllabus.

erty that any mining work done by him on unpatented claims of the company must be counted as representative work, and, if sufficient in amount and done at the proper time, will prevent a forfeiture of the claims.—*Wailes v. Davies* (C. C. A.) 397.

§ 14. A location of an association placer mining claim under Rev. St. §§ 2330, 2331 (U. S. Comp. St. 1901, p. 1432), under an agreement that more than one-third of the claim should be the property of a third party *held* fraudulent and void as against the United States, and not entitled to protection in equity.—*Cook v. Klonos* (C. C. A.) 529.

§ 38. Evidence in a suit to quiet title to a mining claim *held* sufficient prima facie to show that at the time of the location of the claim it was unappropriated public land.—*Cook v. Klonos* (C. C. A.) 529.

§ 2. Operation of mines, quarries, and wells.

§ 99. A member of a mining partnership, who sells his interest, is liable for the subsequent wages of employes who remain in the employment of the partnership after the sale, without knowledge thereof, but not if they have knowledge of the change.—*Kelley v. McNamee* (C. C. A.) 369.

MONEY ORDERS.

See Post Office, § 1.

MONOPOLIES.

§ 1. Trusts and other combinations in restraint of trade.

§ 17. A system of contracts between the manufacturer of a proprietary medicine not protected by patent and dealers in such medicine the purpose and effect of which is to prevent any competition in price between jobbers or retailers *held* illegal both at common law and under the federal anti-trust act of July 2, 1890, c. 647, 26 Stat. 209 (U. S. Comp. St. 1901, p. 3200) where it affects interstate sales.—*Dr. Miles Medical Co. v. John D. Park & Sons Co.* (C. C. A.) 803.

§ 12. Every combination which restrains free competition in interstate trade is a combination in restraint of interstate commerce, in violation of Sherman Act July 2, 1890, c. 647, § 1, 26 Stat. 209 (U. S. Comp. St. 1901, p. 3200).—*United States v. American Tobacco Co.* (C. C.) 700.

§ 17. A corporation for conducting retail tobacco stores *held* not a combination nor monopoly in violation of interstate commerce, in violation of Act July 2, 1890, c. 647, §§ 1, 2, 26 Stat. 209 (U. S. Comp. St. 1901, p. 3200).—*United States v. American Tobacco Co.* (C. C.) 700.

§ 20. A consolidation into one corporation of a large number of tobacco companies, previously competing concerns, *held* a combination in restraint of interstate commerce, in violation of Sherman Act July 2, 1890, c. 647, § 1, 26

Stat. 209 (U. S. Comp. St. 1901, p. 3200).—*United States v. American Tobacco Co.* (C. C.) 700.

MORTGAGES.

As preferential conveyance by bankrupt, see Bankruptcy, § 4.

Intervention by mortgage bond holders in suit by trustee to foreclose corporate mortgage, see Corporations, § 1.

Limitations applicable, see Limitation of Actions, § 1.

On personal property, see Chattel Mortgages. On railroads, see Railroads, § 1.

§ 1. Requisites and validity.

§ 38. The legal presumption is that a deed expresses the intent of the parties, and evidence must be clear to sustain a decree that it was intended as a mortgage.—*Guarantee Gold Bond Loan & Savings Co. v. Edwards* (C. C. A.) 809.

§ 38. Evidence *held* sufficient to show that a deed was intended as a mortgage.—*Guarantee Gold Bond Loan & Savings Co. v. Edwards* (C. C. A.) 809.

§ 2. Redemption.

The fact that a mortgagor was not financially able to redeem from a foreclosure sale will not prevent the running of limitations against his right to redeem.—*Clapp v. Leavens* (C. C. A.) 318.

MOTIONS.

Relating to pleadings, see Pleading, § 3.

For particular purposes or relief.

Direction of verdict in civil actions, see Trial, § 2.

Dismissal in equity case, see Equity, § 4.

New trial in criminal prosecutions, see Criminal Law, § 3.

Quashing indictment or information, see Indictment and Information, § 2.

Striking out evidence, see Trial, § 1.

MUNICIPAL CORPORATIONS.

Judicial notice of municipal ordinance, see Evidence, § 1.

Removal of cause by city to federal court, see Removal of Causes, § 4.

Restraining enforcement of ordinance, see Injunction, § 3.

Right of telegraph or telephone company in street, see Telegraphs and Telephones, § 1.

Street railroads, see Street Railroads.

NAMES.

See Trade-Marks and Trade-Names.

NATIONAL BANKS.

See Banks and Banking, § 1.

*Point annotated. See syllabus.

NATURALIZATION.

See Aliens, § 3.

NAVIGABLE WATERS.

See Canals; Waters and Water Courses; Wharves.

Action by riparian owners to enjoin sale of shore lands by state officers, jurisdiction of federal court, see Courts, § 2.

§ 1. Riparian and littoral rights.

§ 43. An owner of lands in Alaska which border on tidal waters has no title to the soil below high-water mark and cannot enjoin the maintenance of a wharf or other structure in aid of navigation thereon unless it prevents his own free access to the navigable waters.—Decker v. Pacific Coast S. S. Co. (C. C. A.) 974.

§ 43. An equitable owner or claimant of government lands in Alaska on the sea shore may convey his littoral rights to an individual or corporation to enable such grantee to erect or maintain a wharf for the benefit of commerce and navigation.—Decker v. Pacific Coast S. S. Co. (C. C. A.) 974.

NEGLIGENCE.

Instructions as to degree of proof, see Trial, § 3.

By particular classes of persons.

Employers, see Master and Servant, § 1.
Railroad companies, see Railroads, § 2.

Condition or use of particular species of property, works, machinery, or other instrumentalities.

See Explosives; Railroads, § 2; Street Railroads, § 1.

Contributory negligence.

Of passenger, see Carriers, § 4.
Of person injured by operation of railroad, see Railroads, § 2.
Of person injured by operation of street railroad, see Street Railroads, § 1.
Of servant, see Master and Servant, § 1.

§ 1. Contributory negligence.

§ 66. Where a diligent use of the senses by the person injured would have avoided a known or apprehended danger, the failure to use them held contributory negligence.—Chicago, R. I. & P. Ry. Co. v. Baldwin (C. C. A.) 826.

§ 80. One whose negligence directly contributes to an injury cannot recover of another whose negligence concurred to cause it.—Chicago, R. I. & P. Ry. Co. v. Baldwin (C. C. A.) 826.

§ 2. Actions.

§ 136. Where the evidence shows a failure to use the senses, causing the injury complained of, and such evidence is undisputed, the court should instruct that there can be no recovery.—Chicago, R. I. & P. Ry. Co. v. Baldwin (C. C. A.) 826.

NEGOTIABLE INSTRUMENTS.

See Bills and Notes.

NEW TRIAL.

In criminal prosecutions, see Criminal Law, § 3.

NOTES.

Promissory notes, see Bills and Notes.

NOTICE.

Of action or process, see Process, § 2.

Of nonpayment or protest of bill or note, see Bills and Notes, § 2.

Of order of probate court authorizing investment of funds by guardian, see Guardian and Ward, § 1.

Of withdrawal of stockholder of national bank, see Banks and Banking, § 1.

OFFICERS.

Particular classes of officers.

See Clerks of Courts; Receivers.

Assessors of taxes, see Taxation, § 2.

OLEOMARGARINE.

Internal revenue laws as to manner of packing, indictment for violation, see Internal Revenue.

ORDERS.

Authorizing guardian to invest funds of ward, see Guardian and Ward, § 1.

Requiring bankrupt to turn over money or property to his trustee, see Bankruptcy, § 3
Review of appealable orders, see Appeal and Error.

PARENT AND CHILD.

See Guardian and Ward.

Elements of damages for death of parent, see Death, § 1.

PAROL EVIDENCE.

In civil actions, see Evidence, § 2.

PARTIES.

By mortgage bond holders in suit by trustee to foreclose corporate mortgage, see Corporations, § 1.

Character ground of jurisdiction, see Courts, § 2.

In equitable action, see Equity, § 2.

To contract, see Contracts, § 2.

*Point annotated. See syllabus.

PARTNERSHIP.

Authority of partner to verify petition in involuntary bankruptcy, see Bankruptcy, § 1. Bankruptcy of, see Bankruptcy, §§ 4, 7. Mining partnerships, see Mines and Minerals, § 2.

§ 1. Dissolution, settlement, and accounting.

§ 333. The measure of recovery determined in a suit by a partner to wind up the partnership and for a breach of the partnership contract.—Harrison v. Clarke (C. C. A.) 539.

§ 269. A partner held entitled to maintain a suit in equity against his copartner for a dissolution of the partnership and an accounting in respect to the stock of a holding corporation held by defendant as trustee for the partnership.—Pearce v. Sutherland (C. C. A.) 609.

PASSENGERS.

See Carriers, § 4.

PATENTS.

Exceptions to master's report in patent infringement suit, see Equity, § 5. Jurisdiction of federal courts of patent suit, see Courts, § 2.

Operation and effect of former adjudication in patent infringement suit, see Judgment, § 4. Pleading performance of contract for payment of royalties, see Contracts, § 4. To public land, see Public Lands, § 1.

§ 1. Subjects of patents.

A mechanical device designed to accomplish practical results in the packing of explosive gelatin is confined to the specific means employed for doing so.—Eastern Dynamite Co. v. Keystone Powder Mfg. Co. (C. C.) 47.

§ 2. Patentability.

§ 36. Apart from the presumption of novelty arising from the grant of a patent, where it is shown that the patented device has gone into general use, and has superseded prior devices having the same purpose, it is sufficient evidence of invention in a doubtful case.—Morton v. Llewellyn (C. C. A.) 693.

§ 69. It is not competent to read into a publication relied on as an anticipation of a subsequent patent information which it does not give, nor by expert opinion an otherwise uninforming statement by evidence of some apparatus or article not itself competent as an anticipation.—Loew Filter Co. v. German-American Filter Co. of New York (C. C. A.) 855.

*Inventors are not held to the devising of new mechanical forms, or the discovery of hitherto unknown physical principles, but only to the new adaptation and application of those which are already at hand, the question being whether, having regard to what there has been in the past, new and beneficial results have been produced, by means not before employed, amount-

ing to inventive advance.—Eastern Dynamite Co. v. Keystone Powder Mfg. Co. (C. C.) 47.

The making of an invention and its reduction to practice, without any public use or other act placing the public in possession of the invention, although the inventor may by delay in applying therefor lose his right to a patent, does not constitute an abandonment of the invention to the public which will invalidate a patent subsequently granted to another therefor.—Davis & Roesch Temperature Controlling Co. v. National Steam Specialty Co. (C. C.) 191.

§ 17. The making in one piece of that which was formerly made in two, or in two pieces what was made in one when the function of the device is not changed is not invention but the work of the mechanic only.—H. Mueller Mfg. Co. v. A. Y. McDonaly & Morrison Mfg. Co. (C. C.) 991.

§ 3. Persons entitled to patents.

*One who has discovered a new principle in a machine does not lose his right as inventor to a patent therefor, because he employs another to put it in working shape, nor because such other may suggest minor features or improvements.—Eastern Dynamite Co. v. Keystone Powder Mfg. Co. (C. C.) 47.

§ 4. Construction and operation of letters patent.

§ 157. In a suit for infringement of a patent for an alleged invention of which no practical use has ever been made, the patent is not entitled to the same breadth of construction which might be warranted by its proved usefulness.—Boston Woven Hose & Rubber Co. v. Pennsylvania Rubber Co. (C. C. A.) 557.

§ 165. Where one claim of a patent specifically names two elements and another claim specifically names these two elements and in addition thereto a third element, it must be presumed that the patentee intended to limit the claims to the elements enumerated.—Marshall v. Pettingell-Andrews Co. (C. C. A.) 862.

Where in a device not for effecting a certain mechanical result, after specifying a packing screw and its case as the first member of the combination declared for, the second member claimed is an automatically regulated feeding mechanism for supplying material to respond to the screw, and in another claim the other elements are "means for feeding material therefrom to said screw," the claims are bad as a patenting of a principle or function.—Eastern Dynamite Co. v. Keystone Powder Mfg. Co. (C. C.) 47.

§ 5. Title, conveyances, and contracts.

§ 219. Where an exclusive license under a patent is coupled with an express covenant by the licensor to protect the exclusive right so granted, a breach of such covenant by the failure to prosecute known infringers of the patent and by licensing others thereunder is sufficient to defeat the recovery of any royalties contracted to be paid by the licensee.—Wilfley v. New Standard Concentrator Co. (C. C. A.) 421.

*A certified copy of the record of an assignment of a patent, although made evidence where-

*Point annotated. See syllabus.

the original would be evidence by Rev. St. § 892 (U. S. Comp. St. 1901, p. 673), does not prove the genuineness or due execution of the original assignment, nor is it given such effect by section 4898, as amended by Act March 3, 1897, c. 391, § 5, 29 Stat. 692 (U. S. Comp. St. 1901, p. 3387), which makes a certificate of acknowledgment under seal prima facie evidence of the execution of such an assignment.—*Eastern Dynamite Co. v. Keystone Powder Mfg. Co.* (C. C.) 47.

A written instrument by which an inventor purports to assign all his future inventions is not authorized by statute to be recorded in the patent office, and hence such a record is not notice to a subsequent assignee of a patent obtained by such inventor which will invalidate his title.—*Eastern Dynamite Co. v. Keystone Powder Mfg. Co.* (C. C.) 47.

§ 189. The monopoly of a patent does not extend beyond the jurisdiction of the government granting it, and whatever effect a patent granted by one country has in another depends upon the status given to it by the laws of the latter.—*Goodyear Tire & Rubber Co. v. Rubber Tire Wheel Co.* (C. C.) 869.

§ 6. Infringement.

§ 311. The defendant in a suit for infringement of a patent must give notice in his answer of any defense by way of prior patents, publications, or public use relied on to show want of novelty or invention, otherwise such evidence is receivable only to show the state of the art, and to aid in the proper construction of the patent in suit.—*Morton v. Llewellyn* (C. C. A.) 693.

Where there is no proof that the patented article was marked as required by the statute, the complaint will be confined in the accounting to infringement after the bill was filed.—*Eastern Dynamite Co. v. Keystone Powder Mfg. Co.* (C. C.) 47.

*A bill by the equitable owner of a patent against the holder of the legal title to compel a transfer of the patent, and for infringement, is not multifarious.—*Prest-O-Lite Co. v. Avery Portable Lighting Co.* (C. C.) 60.

A suit for infringement of a patent may be maintained by the equitable owner against the patentee.—*Prest-O-Lite Co. v. Avery Portable Lighting Co.* (C. C.) 60.

*Ordinarily a decision of the Patent Office in interference proceedings, awarding a patent to one of two applicants, does not constitute a prior adjudication of the validity of the patent, which will warrant the granting of a preliminary injunction to restrain its infringement, even against the unsuccessful applicant, nor estop him from contesting its validity, except on the ground of his own priority of invention.—*Turner Brass Works v. Appliance Mfg. Co.* (C. C.) 195.

§ 298. Unless a patent is supported by public acquiescence, or prior adjudication, or some other peculiar condition, the complainant's rights must be free from doubt to entitle him to a preliminary injunction.—*Parsons Non-Skid Co. v. Victor Tire Grip Co.* (C. C.) 617.

§ 327. A United States patent, registered in Cuba during its military occupation by the United States, has the status of a Cuban grant, and a suit there for its infringement is based on such grant, and not on the original patent, and is not barred by a decree in the United States between the same parties holding such patent invalid.—*Goodyear Tire & Rubber Co. v. Rubber Tire Wheel Co.* (C. C.) 869.

§ 327. A final decree in favor of the defendant in a patent infringement suit entitles him to continue to make and sell the alleged infringing article free from interference by the complainant by virtue of the patent, and a court of equity having jurisdiction of the parties may by a decree in personam enjoin the complainant from interfering with the defendant's business by bringing suits against his customers, based on the same patent, either in this or a foreign country.—*Goodyear Tire & Rubber Co. v. Rubber Tire Wheel Co.* (C. C.) 869.

§ 7. Decisions on the validity, construction, and infringement of particular patents.

§ 328. The Stockheim patent, No. 378,379, for a process of filtering beer, *held* not anticipated, valid, and infringed as to claims 1, 2, and 4. Claim 3 *held* void for anticipation by a prior publication.—*Loew Filter Co. v. German-American Filter Co. of New York* (C. C. A.) 855.

§ 328. The Wightman patent, No. 411,947, for a rheostat for electric cars, *held* not anticipated and valid, but not infringed.—*Thomson-Houston Electric Co. v. Traction Equipment Co.* (C. C.) 425; *General Electric Co. v. Same, Id.*

§ 328. The Short patent, No. 459,794, for a rheostat for electric cars, *held* not infringed.—*Thomson-Houston Electric Co. v. Traction Equipment Co.* (C. C.) 425; *General Electric Co. v. Same, Id.*

§ 328. The Schrader patent, No. 466,577, for improvements in wheel tires, claim 2, construed, and *held* not infringed.—*Boston Woven Hose & Rubber Co. v. Pennsylvania Rubber Co.* (C. C. A.) 557.

§ 328. The Mueller patent No. 513,272 for a stop and waste cock *held* void for anticipation.—*H. Mueller Mfg. Co. v. A. Y. McDonald & Morrison Mfg. Co.* (C. C.) 991.

§ 328. The Golding patent No. 527,242 for a method of making expanded sheet metal *held* valid and infringed.—*Expanded Metal Co. v. General Fireproofing Co.* (C. C. A.) 849.

§ 328. The Curtis patent No. 557,192, for a device for regulating treatment of substances chronometrically, *held* valid, and infringed as to claims 1 and 4.—*Curtis v. Humphrey* (C. C. A.) 847.

The Browning patent, No. 580,925, for a magazine firearm, claim 14, if conceded invention and validity, *held* not infringed.—*Browning v. Funke* (C. C.) 197.

§ 328. The Liberty patent No. 629,696 for a lath carrying device for paper drying machines, claim 2, construed and *held* not infringed.—

*Point annotated. See syllabus.

Liberty v. Champion International Co. (C. C.) 877.

§ 328. The Walker patents, No. 635,619, and No. 788,803, for soil pipe drainage and venting fittings, *held* valid as disclosing novelty and invention, but not infringed.—Morton v. Llewellyn (C. C. A.) 693.

§ 328. The Elfborg patent, No. 640,456, for an adjustable switch rod, construed, and *held* not infringed.—Ajax Forge Co. v. Morden Frog & Crossing Works (C. C. A.) 843.

The Schrader patent, No. 682,390, for a machine for packing explosive gelatin *held* not anticipated valid and infringed as to claims 5, 6, 7 and 8, and void as to claims 1, 2, 3, 4 and 16.—Eastern Dynamite Co. v. Keystone Powder Mfg. Co. (C. C.) 47.

§ 328. A preliminary injunction against infringement of the Parsons patent, No. 723,929, for an armor for pneumatic tires, denied.—Parsons Non-Skid Co. v. Victor Tire Grip Co. (C. C.) 617.

The Browning patent, No. 730,870, for a magazine firearm, claims 37, 38, and 39, are void for lack of invention.—Browning v. Funke (C. C.) 197.

The Morse patents, No. 736,999, and No. 757,762, for improvements in chain-driving gear and drive chains, construed, and *held* not infringed.—Morse Chain Co. v. Link Belt Machinery Co. (C. C. A.) 331.

§ 328. The Westrum patent No. 752,487, for a method of sprinkling streets, *held* void on its face for lack of invention and novelty.—Westrumite Co. of America v. Com'rs of Lincoln Park (C. C.) 989.

The Roesch patent, No. 759,472, for a thermostat, *held* valid as against the defense of anticipation.—Davis & Roesch Temperature Controlling Co. v. National Steam Specialty Co. (C. C.) 191.

The Critcher patent, No. 781,635, for a combination undergarment for women, construed, and *held* valid and infringed.—Leona Garment Co. v. Jenks (C. C. A.) 188.

§ 328. The Marshall patent No. 784,695 for an insulating lining, claims 5 and 9 *held* void for lack of novelty and invention.—Marshall v. Pettingell-Andrews Co. (C. C. A.) 862.

§ 8. Patents enumerated.

ENGLISH.

1899.

2,251. Electrical resistance, cited..... 435

FRENCH.

8,692. Cited 848

UNITED STATES.

ORIGINAL.

25,532. Improved electrical heating apparatus, cited..... 433

125,362. Machine for varnishing and coloring lead pencils, cited..... 848

160,092. Automatic clock-operated horse crib, cited..... 848

209,874. Filtering process for beer, cited.. 856

222,765. Paper drying machine, cited..... 878

284,051. Automatic egg boiler, cited..... 848

320,242. Method of making expanded sheet metal, cited..... 850

322,871. Paper drying machine, cited..... 878

324,176. Electric railway, cited..... 435

326,603. Switch for electric motor and other circuits, cited.....433, 436

375,497. Clock-alarm, cited..... 848

378,379. Filtering process for beer, *held* not anticipated, valid and infringed as to claims 1, 2 and 4. Claim 3 *held* void for anticipation by a prior publication.. 855

381,815. Heating by electricity, cited.... 433

381,816. Electric heating apparatus for railway cars, cited..... 433

394,035. Electric motor, cited...433, 435, 436

403,446. Egg boiler, cited..... 848

409,135. Electrical resistance, cited..... 433

411,947. Rheostat for electric cars, *held* not anticipated and valid, but not infringed by patent No. 687,569425, 426

415,697. Armature, cited..... 435

432,205. Electric heater, cited..... 435

433,391. Armature for dynamos, cited... 435

459,794. Rheostat for electric cars, *held* not infringed.....425, 426

466,577. Improvement in wheel tire, claim 2 construed and *held* not infringed 557

513,272. Stop and waste cock, *held* void for anticipation..... 991

516,217. Rheostat, cited..... 435

527,242. Method of making expanded sheet metal, *held* valid and infringed 849, 850

530,727. Rheostat, cited..... 435

548,867. Rheostat, cited..... 435

554,765. Rubber tire, cited..... 870, 872

557,192. Automatic egg boiler, *held* valid and infringed as to claims 1 and 4..... 847

571,260. Magazine firearm, cited..... 197

575,189. Method of sprinkling streets, cited 990

577,793. Drainage pipe fittings, cited.... 694

580,925. Magazine firearm, claim 14 if conceded invention and validity, *held* not infringed..... 197

619,932. Mechanical cashier, cited..... 200

629,696. Lath-carrying device for paper drying machines, claim 2 construed and *held* not infringed.. 877

635,619. Drainage pipe fittings, *held* valid as disclosing novelty and invention but not infringed.....693, 697

640,456. Adjustable switch rod, construed and *held* not infringed by patent No. 679,153.....843, 844, 845

641,546. Battery filler, cited.....1023

648,481. Electrical resistance, cited..... 435

679,153. Adjustable switch rod, *held* not to infringe patent No. 640,456 843, 845

*Point annotated. See syllabus.

682,390. Machine for packing explosive gelatin held not anticipated, valid and infringed as to claims 5, 6, 7 and 8, and void as to claims 1, 2, 3, 4 and 16. 47

687,569. Rheostat for electric cars, held not to infringe No. 411,947 425, 426

700,477. Combination undergarment for women, cited. 190

723,299. Armor for pneumatic tire, held not so clearly valid or supported by general acquiescence as to warrant the granting of a preliminary injunction against an alleged infringer. 617

730,870. Magazine firearm, claims 37, 38, and 39, held void for lack of invention 197, 199

736,999. Improvement in chain driving gear, construed and held not infringed 331, 332. 333

752,487. Method of sprinkling streets, held void 989

757,762. Drive chain, construed and held not infringed. 331, 332. 333

759,472. Thermostat, held valid as against the defense of anticipation 192, 193

764,822. Air-vents, cited. 192

765,556. Combination undergarment for women, cited. 190

781,635. Combination undergarment for women, construed and held valid and infringed. 188, 190

784,695. Insulating lining, claims 5 and 9 held void for lack of novelty and invention. 862

788,803. Drainage pipe fittings, held valid as disclosing novelty and invention but not infringed. 693, 695

809,526. Battery filler, cited. 1023

875,544. Automobile fender, cited. 195

PENALTIES.

For infringement of copyright, see Copyright, § 2.

For violation of law relating to carriage of live stock, see Carriers, § 3.

Under contracts, see Damages, § 2.

PERSONAL INJURIES.

Particular causes or means of injury.
See Explosives; Negligence; Seamen; Street Railroads, § 1.

Operation of railroads, see Railroads, § 2.

Particular classes of persons injured.
Employé, see Master and Servant, § 1.
Passenger, see Carriers, § 4.
Stevedore, see Shipping, § 1.
Traveler on highway crossing railroad, see Railroads, § 2.

Remedies.

Applicability of instructions to case, see Trial, § 3.

PETITION.

In judicial proceedings.

See Bankruptcy, § 1; Habeas Corpus, § 1.
For discharge of bankrupt, see Bankruptcy, § 8.

PIERS.

See Wharves.

PLEADING.

Adoption by United States courts of practice of state courts, see Courts, § 2.
Applicability of instructions to pleadings, see Trial, § 3.
Conformity of judgment to pleadings, see Judgment, § 2.

Allegations as to particular facts, acts, or transactions.

See Judgment, § 6; Statutes, § 4.

In actions by or against particular classes of persons.

Trustee in bankruptcy, see Bankruptcy, § 6.

In particular actions or proceedings.

See Equity, § 3.
Bankruptcy proceedings, see Bankruptcy, § 1.
Condemnation proceedings, see Eminent Domain, § 1.
For breach of contract, see Contracts, § 4.
For infringement of patent, see Patents, § 6.
Indictment or criminal information or complaint, see Indictment and Information.

§ 1. Replication or reply and subsequent pleadings.

§ 180. The performance of all conditions precedent to a plaintiff's right of action, or a waiver of any or all of the same, must be pleaded in his declaration; and, where that alleges performance, plaintiff cannot, by a replication to a plea taking issue as to the performance of a specified condition, set up a waiver of the same.—Stratton v. Essex County Park Commission (C. C.) 901.

§ 2. Signature and verification.

§ 290. A plaintiff cannot file a replication concluding with a verification to a plea which concludes to the country.—Stratton v. Essex County Park Commission (C. C.) 901.

§ 3. Motions.

§ 355. A replication, like a plea, must be single, and, while duplicity does not render it subject to demurrer, it does to a motion to strike out under the New Jersey practice.—Stratton v. Essex County Park Commission (C. C.) 901.

PLEDGES.

A contract construed in connection with other related contracts, and held to evidence a sale and not a hypothecation of notes, which entitled the receivers of the seller to recover the unpaid

*Point annotated. See syllabus.

portion of the purchase money.—*Joline v. Metropolitan Securities Co.* (C. C.) 144.

POLICY.

Of insurance, see Insurance.

POSSESSION.

See Adverse Possession.

POST OFFICE.

Following language of statute, see Indictment and Information, § 1.

Sufficiency of indictment for using mails to defraud, see Indictment and Information, § 1.

§ 1. Mailable matter, transmission and delivery of mail, and money orders.

Whoever deals with an agent of the United States must assure himself of the agent's authority, and one in whose favor a postmaster or postal clerk issues a money order without first receiving an application and payment therefor, as required by law, is liable to the United States for its value, although he may have paid such agent in good faith in other ways the full value of the order.—*United States v. Bolognesi* (C. C.) 159.

§ 2. Offenses against postal laws.

§ 35. A letter mailed in furtherance of a scheme to defraud, in order to support an indictment under Rev. St. § 5480, as amended in 1889 (Act March 2, 1889, c. 393, 25 Stat. 873 [U. S. Comp. St. 1901, p. 3696]), need not in itself be effective to execute such scheme, but it is sufficient if it was designed for that purpose or to assist in it.—*Lemon v. United States* (C. C. A.) 953.

§ 35. Rev. St. § 5480, as amended in 1889 (Act March 2, 1889, c. 393, 25 Stat. 873 [U. S. Comp. St. 1901, p. 3696]), making it a criminal offense to use the mails in the execution of schemes to defraud, although it specifically names schemes to dispose of counterfeit or spurious money, is not confined to such schemes, but by its terms embraces "any scheme or artifice to defraud."—*Lemon v. United States* (C. C. A.) 953.

§ 50. Instructions requested by defendants on trial for a fraudulent use of the mails considered, and held properly refused.—*Lemon v. United States* (C. C. A.) 953.

§ 48. An indictment under Rev. St. § 5480, as amended in 1889 (Act March 2, 1889, c. 393, 25 Stat. 873 [U. S. Comp. St. 1901, p. 3696]), for using the mails to defraud, considered, and held sufficient.—*Lemon v. United States* (C. C. A.) 953.

§ 48. An indictment under Rev. St. § 5480 (U. S. Comp. St. 1901, p. 3696), for fraudulent use of the mails, may include counts charging offenses in different periods of six months, and on conviction sentence may be imposed on each

of such counts.—*United States v. McVickar* (C. C.) 894.

*An indictment under Rev. St. § 3893, as amended by Act July 12, 1876, c. 186, 19 Stat. 90, and Act Sept. 26, 1888, c. 1039, 25 Stat. 496 (U. S. Comp. St. 1901, p. 2658), for mailing a letter giving information where, how, and of whom and by what means articles and things intended for the procuring of an abortion could be obtained, construed, and held sufficient.—*United States v. Somers* (D. C.) 259.

PRACTICE.

Adoption by United States courts of practice of state courts, see Courts, § 2.

In particular civil actions or proceedings.

See Habeas Corpus, § 1.

Particular proceedings in actions.

See Evidence; Judgment; Jury; Limitation of Actions; Pleading; Process; Removal of Causes, § 1; Trial.

Particular remedies in or incident to actions.

See Injunction; Receivers.

Procedure in criminal prosecutions.

See Bail, § 1; Criminal Law; Extradition.

Procedure in exercise of special or limited jurisdiction.

In admiralty, see Admiralty.

In bankruptcy, see Bankruptcy, § 1.

Procedure in or by particular courts or tribunals.

See Courts.

Procedure on review.

See Appeal and Error.

PREFERENCES.

By bankrupt, see Bankruptcy, § 1.

Effect of proceedings in bankruptcy, see Bankruptcy, § 4.

PREJUDICE.

Ground for reversal in civil actions, see Appeal and Error, § 4.

PRELIMINARY INJUNCTION.

See Injunction, § 3.

Restraining infringement of patent, see Patents, § 6.

PRESCRIPTION.

Acquisition of rights, see Waters and Water Courses, § 2.

PRESENTMENT.

Of bill or note, see Bills and Notes, § 2.

*Point annotated. See syllabus.

PRESUMPTIONS.

In criminal prosecutions, see Criminal Law, § 1.
On appeal or error, see Appeal and Error, § 4.

PRINCIPAL AND AGENT.

See Brokers.

PRINCIPAL AND SURETY.

See Bail.

Status of bail bond given by surety company for appearance of defendant in a criminal case in the federal court, see Bail, § 1.

PRIORITIES.

Of taxes, see Taxation, § 3.

PROCESS.

See Injunction; Mandamus.

Sufficiency to sustain judgment, see Judgment, § 1.

§ 1. Nature, issuance, requisites, and validity.

§ 6. Where respondents have been brought under the jurisdiction of the court by proper service, the jurisdiction is not lost by an amendment of the complaint whereby a necessary jurisdictional allegation is inserted.—Goodman v. City of Ft. Collins (C. C. A.) 970.

§ 2. Service.

§ 100. Under Mansf. Dig. Ark. § 4991, authorizing service by publication of a warning order when the complaint shows that the names of such heirs are unknown, an averment to that effect is indispensable to the validity of such an order.—Indiana & Arkansas Lumber & Mfg. Co. v. Brinkley (C. C. A.) 963; Deutsch v. Snowden, Id.

§ 66. A summons *held* not void because issued on a complaint wanting in the requisite jurisdictional allegations, the same being amendable, or because a copy of the defective complaint is attached to the summons as served.—Goodman v. City of Ft. Collins (C. C. A.) 970.

§ 68. Due personal service of a summons brings a respondent before the court for all purposes as fully as would a voluntary appearance.—Goodman v. City of Ft. Collins (C. C. A.) 970.

PROMISSORY NOTES.

See Bills and Notes.

PROPERTY.

Constitutional guaranties of rights of property, see Constitutional Law, § 2.

Particular species of property.

See Copyrights; Mines and Minerals; Shipping; Trade-Marks and Trade-Names.

Remedies involving or affecting property.

Protection of rights of property by injunction, see Injunction, § 2.

Transfers and other matters affecting title.

See Adverse Possession.

Taking for public use, see Eminent Domain.

PROTEST.

Of bill or note, see Bills and Notes, § 2.

PROXIMATE CAUSE.

Direct or remote consequences of injury, see Damages, § 1.

PUBLICATION.

Service of process, see Process, § 2.

PUBLIC LANDS.

Appropriation of water rights, see Waters and Water Courses, § 1.

Jurisdiction of federal courts of actions concerning public lands, see Courts, § 2.

Mineral lands, see Mines and Minerals, § 1.

Right of telephone company to use, see Telegraphs and Telephones, § 1.

§ 1. Survey and disposal of lands of United States.

§ 35. Under Act May 14, 1880, c. 89, § 3, 21 Stat. 140 (U. S. Comp. St. 1901, p. 1393), which extends to homestead settlers on unsurveyed public lands the same right as pre-emption settlers to perfect their right by application made within three months after the filing of the plat of survey, the failure to file within such time does not affect the settler's right, except as against another claimant who has acquired or initiated some right before the application is in fact made.—Trodict v. Northern Pac. Ry. Co. (C. C. A.) 913.

§ 35. The fact that a settler who is actually residing on public land with the bona fide intention of acquiring title thereto under the homestead law purchased his improvements from a prior settler does not affect his right to so acquire the land.—Trodict v. Northern Pac. Ry. Co. (C. C. A.) 913.

§ 79. Unsurveyed land within the primary limits of the grant to the Northern Pacific Railroad Company by Act July 2, 1864 (13 Stat. 365, c. 217), as fixed by the definite location of the road, but which at the time of the filing of the map of such location was actually occupied by a settler, who had made improvements thereon with the bona fide intention of acquiring title thereto under the homestead law when it should be surveyed, was subject to a "claim or right" within the meaning of the act, and did not pass

*Point annotated. See syllabus.

under the grant.—Trodict v. Northern Pac. Ry. Co. (C. C. A.) 913.

§ 120. A patent to public land sold as an isolated tract under Act Feb. 26, 1895, c. 133, 28 Stat. 627 (U. S. Comp. St. 1901, p. 1519), held not subject to cancellation at suit of the United States on the ground of fraud of the purchaser in failing to state in the application for purchase that a portion of the land was occupied by an Indian who had no color of title thereto.—United States v. Casterlin (C. C.) 437.

PUBLIC SERVICE CORPORATIONS.

See Carriers; Railroads; Street Railroads; Telegraphs and Telephones.

PUBLIC USE.

Taking property for public use, see Eminent Domain.

QUASHING.

Indictment or information, see Indictment and Information, § 2.

QUESTIONS FOR JURY.

In civil actions, see Trial, § 2.

QUIETING TITLE.

To mining claim, see Mines and Minerals, § 1.

RAILROADS.

See Street Railroads.

Carriage of goods and passengers, see Carriers. Grants of land in aid, see Public Lands, § 1.

§ 1. Indebtedness, securities, liens, and mortgages.

§ 190. In consolidated suits to foreclose various liens upon railroad property, upon the question of ordering a sale of the property in advance of a determination of the rights of the several parties and the right of bondholders to intervene, a plan of reorganization, proposed by certain of the bondholders, may properly be considered.—Bowling Green Trust Co. v. Virginia Passenger & Power Co. (C. C.) 753.

§ 192. In a suit to foreclose various liens on railroad property, it is within the discretion of the court to order a sale of the property in advance of settling the respective rights and priorities of the parties.—Bowling Green Trust Co. v. Virginia Passenger & Power Co. (C. C.) 753.

§ 2. Operation.

§ 261. Where the trains of one railroad company in charge of its own employes run over the tracks of another company under a contract that they shall obey the orders of the train dispatcher of the latter company, such contract does not relieve the company so using the tracks

from liability for injuries caused to third persons by the negligence of its employes operating its trains in no way attributable to any order of the train dispatcher.—Hamble v. Atchison, T. & S. F. Ry. Co. (C. C. A.) 410.

§ 400. In an action for the killing or injury of a person by a railroad train at a station, where there is testimony of apparently credible witnesses who had an opportunity to observe the fact that the bell or whistle on the engine was not sounded, although such testimony is necessarily negative and although it may be contradicted by positive testimony, the question is one for the jury.—Chicago, R. I. & P. Ry. Co. v. Stepp (C. C. A.) 785.

§ 400. Whether the running of a railroad train through station grounds at a certain rate of speed constituted negligence on the part of the company depends upon the surrounding circumstances, and, when in issue in an action for the killing of a person on the track, is a question for the jury.—Chicago, R. I. & P. Ry. Co. v. Stepp (C. C. A.) 785.

§ 261. The fact that a railroad train owned by one company and operated by its servants, while being run over a track used jointly with another company, is subject to the rules and regulations of the latter company and the orders of its train dispatcher, does not relieve the owner from liability for an injury to a person by such train resulting from its negligent operation.—Chicago, R. I. & P. Ry. Co. v. Stepp (C. C. A.) 785.

§ 372. A railroad company which ran a train past a station at which another train was receiving and discharging passengers at a rate of speed which in itself constituted negligence under the circumstances is liable for an injury to a person of which such negligence was the proximate cause, whether or not the particular injury that resulted could have been foreseen.—Chicago, R. I. & P. Ry. Co. v. Stepp (C. C. A.) 785.

§ 383. Facts held to establish that the superintendent in charge of the repairs of a railroad bridge, knocked off the same by an engine and killed, was guilty of contributory negligence.—Chicago, R. I. & P. Ry. Co. v. Baldwin (C. C. A.) 826.

*Evidence held to warrant a finding by the jury that a plaintiff, who was struck and injured while driving over a railroad crossing, was not chargeable with contributory negligence.—Flannely v. Delaware & H. Co. (C. C.) 303.

RATE.

Of carrier, see Carriers, § 1.

REAL ESTATE AGENTS.

See Brokers.

REBATES.

See Carriers, § 1.

*Point annotated. See syllabus.

RECEIVERS.

Appointment by state court as affecting jurisdiction of courts of bankruptcy in proceedings against corporation, see Bankruptcy, § 1.
Of bankrupt, see Bankruptcy, § 1.

§ 1. Actions.

That a receiver was appointed for a corporation in an equity suit in the federal courts did not entitle the receiver to maintain a bill in such proceedings equivalent to a plenary suit in equity against a third person on a purely legal demand.—Whelan v. Enterprise Transp. Co. (C. C.) 95.

RECORDS.

Judicial notice of, see Evidence, § 1.
Transcript on appeal or writ of error, see Appeal and Error, § 3.

REDEMPTION.

From mortgage, see Mortgages, § 2.

REFEREES.

In bankruptcy, see Bankruptcy, § 5.

REFERENCE.

Review of findings of master on appeal or writ of error, see Appeal and Error, § 4.
To master or commissioner in equity, see Equity, § 5.

REFORMATION OF INSTRUMENTS.

See Cancellation of Instruments.

REMOVAL OF CAUSES.

§§ 1, 2. **Origin, nature, and subject of controversy.**

§ 26. An action brought by a nonresident alien in a state court against a citizen of another state is removable by the defendant where the requisite amount is involved.—Barlow v. Chicago & N. W. Ry. Co. (C. C.) 765.

§ 3. **Citizenship or alienage of parties.**

*The word "defendant," as used in the removal act (Act March 3, 1875, c. 137, § 2, 18 Stat. 470, as amended by Act March 3, 1887, c. 373, § 1, 24 Stat. 552, and Act Aug. 13, 1888, c. 866, § 1, 25 Stat. 433 [U. S. Comp. St. 1901, p. 509]), includes only a party who is a defendant on the record in the state court.—Illinois Cent. R. Co. v. A. Waller & Co. (C. C.) 358.

*A plaintiff in a suit in a state court for the recovery of a sum less than \$2,000 does not become theoretically or constructively a defendant, so as to entitle him to remove the cause on the ground of diversity of citizenship, because the defendant in his answer sets up a

counterclaim for more than \$2,000, as permitted by the statute of the state.—Illinois Cent. R. Co. v. A. Waller & Co. (C. C.) 358.

§ 42. A state is without power by the mere form of procedure prescribed to deprive the owner of property sought to be taken by condemnation proceedings from removing such proceedings into federal court if such owner be a citizen of a foreign state and the value of the property exceeds the jurisdictional amount.—Kansas City v. Metropolitan Water Co. (C. C.) 728.

§ 42. A proceeding instituted in a state court by a city, to condemn the property of a water company, under Laws Kan. 1908, p. 30, c. 33, is a suit at law removable into a federal court where the requisite amount is involved and the company is a citizen of another state, and the timely filing of a proper petition and bond for removal deprives the state court of jurisdiction to proceed further therein.—Metropolitan Water Co. v. Kansas City (C. C.) 728.

§ 4. **Proceedings to procure and effect of removal.**

§ 79. Proceedings by a city for the condemnation of the plant of a water company under Laws Kan. 1908, p. 30, c. 33, are removable by the defendant when a citizen of another state at any time after their inception by application to the judge of a state court for the appointment of commissioners to appraise the property and assess damages.—Kansas City v. Metropolitan Water Co. (C. C.) 728.

§ 89. Where a proper petition and bond for the removal of a cause are presented to a state court, the refusal of such court to order the removal does not require the defendant to proceed with the trial in that court, but he may at his option file a copy of the record in the federal court and require the plaintiff to there contest the question of the right of removal and such is the better practice.—Barlow v. Chicago & N. W. Ry. Co. (C. C.) 765.

RENT.

Rental for use of street by telegraph company, see Telegraphs and Telephones, § 1.

REPLEVIN.

Conformity to pleadings, see Judgment, § 2.

REPLICATION.

See Pleading, § 1.

REPORT.

Of master, see Equity, § 5.

RESCISSION.

Cancellation of written instrument, see Cancellation of Instruments.

*Point annotated. See syllabus.

RES JUDICATA.

See Judgment, § 4.

RESTRAINT OF TRADE.

Trusts and other combinations, see Monopolies, § 1.

REVENUE.

See Customs Duties; Internal Revenue; Taxation.

REVIEW.

See Appeal and Error.
Of orders of interstate commerce commission, see Commerce, § 2.

RIPARIAN RIGHTS.

See Navigable Waters, § 1.

RISKS.

Assumed by employé, see Master and Servant, § 1.
Within insurance policy, see Insurance, § 2.

ROYALTIES.

On sale of patented articles, see Patents, § 5.

SAFETY APPLIANCES.

Interstate commerce regulations as to appliances used by railroads, see Commerce, § 2.

SAILORS.

Right to naturalization as dependent on continuous residence within country, see Aliens, § 3.

SALES.

Of public lands, see Public Lands, § 1.
Monopoly in sale of goods, see Monopolies, § 1.
Nature of contract as affecting title of trustee in bankruptcy, see Bankruptcy, § 3.
Of realty, see Vendor and Purchaser.
Right of trustee of bankrupt to property held by bankrupt under unrecorded contract of conditional sale, see Bankruptcy, § 3.
Specific performance of contracts of, see Specific Performance, § 1.

§ 1. Requisites and validity of contract.

§ 7. Contracts between the manufacturer of a proprietary medicine and jobbers to whom it is consigned for sale *held* to be contracts of sale and not of agency.—Dr. Miles Medical Co. v. John D. Park & Sons Co. (C. C. A.) 803.

§ 22. The verbal acceptance by a plaintiff of a written offer made by the defendant to sell and deliver a quantity of coal, construed in the light of a contract subsequently prepared by plaintiff for signature which was materially variant from such offer *held* not such an unconditional acceptance as to create a contract binding on defendant.—Hite & Rafetto v. Savannah Electric Co. (C. C. A.) 944.

§ 2. Operation and effect.

§ 201. Acts of delivery under a contract to furnish railroad ties *held* sufficient to pass title to the ties so delivered.—McDonald v. Clearwater Shortline Ry. Co. (C. C.) 1007.

§ 202. On sale and delivery of ties on railroad right of way, title *held* to pass though payment had not been made.—McDonald v. Clearwater Shortline Ry. Co. (C. C.) 1007.

§ 3. Remedies of seller.

*Notice, by purchasers of securities which were to be delivered at a stated time and place, that they could not then receive and pay for the securities, *held* to excuse a tender at such time and place by the sellers to entitle them to maintain an action for breach of contract.—Watson, Preston & Co. v. Greenwood & Co. (C. C.) 294.

§ 4. Remedies of buyer.

§ 442. In an action to recover the price of railroad ties delivered under a contract of sale, the costs and expenses incurred by the purchaser by reason of an action in trespass by the United States for certain of the ties cut on government land *held* recoverable by defendant by way of counterclaim.—McDonald v. Clearwater Shortline Ry. Co. (C. C.) 1007.

SALVAGE.**§ 1. Amount and apportionment.**

§ 34. A tug *held* entitled to a salvage award of \$3,500 for towing a schooner laden with railroad ties, which had been disabled in collision, from a point off the New Jersey coast to the Delaware Breakwater, the service requiring 30 hours and a deviation by the tug from her course with her three tows of some 35 miles.—The Benjamin A. Van Brunt (D. C.) 775.

SCHEDULE.

Of bankrupt, see Bankruptcy, § 1.

SEAMEN.

§ 29. A libellant, 17 years old, employed as mess boy on a steamer, who was ordered to perform work not in the line of his employment and with which he was not familiar, *held* not to have assumed the risk, and to be entitled to recover from the vessel for an injury received while so working.—Smith v. Cook (D. C.) 628.

§ 3. A British seaman serving on an English vessel who voluntarily left such vessel in New York *held* to have no right of action against the ship for wages which would be enforced by a

*Point annotated. See syllabus.

court of admiralty of the United States.—The *Ucayali* (D. C.) 897.

SEARCHES AND SEIZURES.

Admissibility, in criminal prosecution of evidence obtained by wrongful search warrant, see Criminal Law, § 1.

Authority to issue a writ for the seizure of infringing copies of a copyright publication, see Copyrights, § 2.

Wrongful conversion of property taken from prisoner, see Trover and Conversion, § 1.

SECONDARY EVIDENCE.

In criminal prosecutions, see Criminal Law, § 1.

SENTENCE.

In criminal prosecutions, see Criminal Law, § 4.

SERVICE.

Of process, see Process, § 2.

SET-OFF AND COUNTERCLAIM.

Filing of counterclaim for more than two thousand dollars as giving right of removal to federal court by plaintiff, see Removal of Causes, § 3.

In action for breach of warranty, see Sales, § 4.

§ 1. Subject-matter.

§ 36. Under Civ. Code Proc. Cal. § 438, a promissory note given by a plaintiff to the defendant and arising out of the same transaction sued on may be pleaded as a counterclaim if due when pleaded, although not due when the action was commenced.—*Californian Canneries Co. v. Pacific Sheet Metal Works* (C. C. A.) 978.

SETTING ASIDE.

Order of interstate commerce commission, see Commerce, § 2.

SEWERS.

Construction of contract to construct, see Contracts, § 2.

SHERIFFS AND CONSTABLES.

Wrongful conversion of property taken from prisoner, see Trover and Conversion, § 1.

SHIPPING.

See Admiralty; Salvage; Seamen; Towage; Wharves.

Indictment against master for permitting unlawful landing of Chinese, see Aliens, § 1. Liability of shipper for injuries caused by explosive cargo, see Explosives.

§ 1. Liabilities of vessels and owners in general.

§ 86. Evidence *held* not to sustain the allegation of a libel that the injury of libellant while employed by a stevedore discharging a vessel was due to defects in the winch, supplied by the vessel, which would render her liable therefor.—*The Ranza* (D. C.) 699.

§ 2. Demurrage.

§ 173. Under a charter party which placed the duty of discharging and delivering the cargo alongside upon the owners, neither the charterer nor cargo can be held liable for demurrage because of delay in discharging beyond the stipulated lay days, without proof that it was through the fault of one or the other.—*West Hartlepool Steam Navigation Co. v. Virginia-Carolina Chemical Co.* (C. C. A.) 836.

*A charterer *held* not liable for demurrage, under a charter requiring the discharge of a certain quantity of cargo each weather working day, because of a stoppage of work on account of rain, where the cargo was of a character easily damaged by water.—*Pyman S. S. Co. v. One Hundred Tons of Kainit* (D. C.) 364.

§ 178. A charterer *held* liable for demurrage where it failed to provide the vessel with a berth under a contract providing that days for loading should commence at 6 o'clock a. m. the day after her report of readiness, although the charterer was not in fault for the delay which was due to a third party.—*Pyman S. S. Co. v. Mexican Central Ry. Co.* (D. C.) 441.

SIGNATURES.

To pleading, see Pleading, § 2.

SMUGGLING.

See Customs Duties, § 4.

SPECIAL LAWS.

See Statutes, § 2.

SPECIFIC PERFORMANCE.

§ 1. Contracts enforceable.

*A contract for the conveyance of phosphate rock under certain land, a right of way over other land, and a washer site on a river *held* not so vague and uncertain as to be incapable of specific performance.—*Bradley v. Heyward* (C. C.) 107.

*Alleged hardship resulting to the defendant only from alleged inadequate consideration *held* insufficient to justify the denial of a decree for the specific performance of a contract to convey all phosphate rock underlying certain land.—*Bradley v. Heyward* (C. C.) 107.

*Point annotated. See syllabus.

In a suit to compel specific performance of a contract to convey the phosphate rock underlying certain land, an alleged mistake, in that it was defendant's intention to sell only that portion of the rock that underlay about 100 acres of the land which had been already partially mined, held no defense.—Bradley v. Heyward (C. C.) 107.

*A contract for the sale of phosphate rock underlying certain land held not so unconscionable nor based on such a grossly inadequate consideration as would justify the refusal of specific performance.—Bradley v. Heyward (C. C.) 107.

A written contract by which the assignor of a patent agreed to convey to the assignee any future inventions made by him relating to the device of the patent or to improvements thereon is not in violation of public policy, and may be specifically enforced, where necessary to secure to the assignee the value of the patent purchased.—Fairchild v. Dement (C. C.) 200.

STALE DEMAND.

See Equity, § 1.

STATEMENT.

By witness inconsistent with testimony, see Witnesses, § 1.
Of case or facts for purpose of review, see Appeal and Error, § 3.

STATES.

Courts, see Courts.
Effect of judgment of court of other state, see Judgment, § 5.
Jurisdiction of federal courts of action against state, see Courts, § 2.
Powers to tax, see Taxation, § 1.

STATUTES.

Adoption by United States courts of state laws as rules of decision, see Courts, § 2.
Laws denying due process of law, see Constitutional Law, § 2.
Statutes relating to liability of railroads to their employes, see Master and Servant, § 1.
Statutes relating to telegraph or telephone franchises, see Telegraphs and Telephones, § 1.

Provisions relating to particular subjects.

See Aliens, §§ 1, 3; Bail, § 1; Bankruptcy, §§ 1, 3-7, 9; Banks and Banking, § 1; Bills and Notes, § 2; Canals, § 1; Carriers, §§ 1-3; Commerce, §§ 2, 4; Conspiracy, § 2; Copyrights, § 2; Courts, §§ 2, 3; Customs Duties, §§ 1-4; Death, § 1; Equity, § 4; Extradition, § 1; Fraudulent Conveyances, § 1; Habeas Corpus, § 1; Indictment and Information, § 1; Insurance, § 2; Internal Revenue; Judgment, § 5; Limitation of Actions, § 1; Master and Servant;

Monopolies, § 1; Patents, § 5; Post Office, § 2; Process, § 2; Public Lands, § 1; Removal of Causes, § 3; Set-Off and Counterclaim, § 1; Telegraphs and Telephones, § 1; Trial, §§ 3, 4; Waters and Water Courses, § 1.

Revenue laws, see Internal Revenue.

§ 1. Enactment, requisites, and validity in general.

*Act Colo. March 28, 1901 (Sess. Laws 1901, p. 161, c. 67), abrogating the fellow servant rule of the common law, never became a law, because, as shown by the published legislative journals, the constitutional mandate relating to the entry of the vote upon the final passage of a bill was not observed in its enactment.—Portland Gold Min. Co. v. Duke (C. C. A.) 180.

*Const. Colo. art. 5, § 22, providing that no bill shall become a law unless on its final passage the vote be taken by ayes and noes, and the names of those voting be entered on the journal, is mandatory, as construed by the Supreme Court.—Portland Gold Min. Co. v. Duke (C. C. A.) 180.

§ 2. General and special or local laws.

§ 93. Laws Kan. 1908, p. 30, c. 33, authorizing cities of the first class, having a population of over 50,000 to acquire waterworks property by condemnation is not in violation of the Constitution of the state [art. 2, § 17, art. 12, §§ 1, 5] as special legislation.—Metropolitan Water Co. v. Kansas City (C. C.) 738.

§ 3. Construction and operation.

*In the construction of statutes imposing taxes, and especially burdens of special or unusual nature, in cases of doubt or ambiguity, every intendment is to be taken against the taxing power.—Lynch v. Union Trust Co. of San Francisco (C. C. A.) 161.

§ 4. Pleading and evidence.

Whether or not a purported public statute is a law is a question of law, which may be determined as any other question is presented and determined, and cannot be made an issue of fact by the pleadings.—Portland Gold Min. Co. v. Duke (C. C. A.) 180.

STATUTES CONSTRUED.

UNITED STATES.

CONSTITUTION.

Amend. 5	215
Amend. 10	347
Amend. 11	1
Art. 1, § 8, subd. 3.....	347

STATUTES AT LARGE.

1864, July 2, ch. 217, 13 Stat. 365.....	913
1866, July 24, ch. 230, 14 Stat. 221 (U. S. Comp. St. 1901, pp. 3579-3581).....	561
1875, March 3, ch. 137, § 1, 18 Stat. 470. Amended by Act 1887, March 3, ch. 373, 24 Stat. 552; Act 1888, Aug. 13, ch. 866, 25 Stat. 433 (U. S. Comp. St. 1901, p. 508)	290

*Point annotated. See syllabus.

1875, March 3, ch. 137, § 2, 18 Stat. 470. Amended by Act 1887, March 3, ch. 373, § 1, 24 Stat. 552; Act 1888, Aug. 13, ch. 866, § 1, 25 Stat. 433 (U. S. Comp. St. 1901, p. 509).....	358	1897, July 24, ch. 11, § 1, Schedule G, pars. 262, 263, 30 Stat. 171 (U. S. Comp. St. 1901, p. 1651).....	910
1876, July 12, ch. 186, 19 Stat. 90.....	259	1897, July 24, ch. 11, § 1, Schedule G, par. 283, 30 Stat. 172 (U. S. Comp. St. 1901, p. 1652).....	907
1880, May 14, ch. 89, § 3, 21 Stat. 140 (U. S. Comp. St. 1901, p. 1393).....	913	1897, July 24, ch. 11, § 1, Schedule I, par. 302, 30 Stat. 175 (U. S. Comp. St. 1901, p. 1655).....	65
1882, July 12, ch. 290, § 5, 22 Stat. 163 (U. S. Comp. St. 1901, p. 3458).....	830	1897, July 24, ch. 11, § 1, Schedule J, par. 337, 30 Stat. 180 (U. S. Comp. St. 1901, p. 1662).....	285
1886, Aug. 2, ch. 840, § 6, 24 Stat. 210 (U. S. Comp. St. 1901, p. 2230).....	772	1897, July 24, ch. 11, § 1, Schedule L, par. 386, 30 Stat. 186 (U. S. Comp. St. 1901, p. 1669).....	912
1887, Feb. 4, ch. 104, 24 Stat. 379 (U. S. Comp. St. 1901, p. 3154). Amended by Act 1906, June 29, ch. 3591, 34 Stat. 584 (U. S. Comp. St. Supp. 1907, p. 894).....	215	1897, July 24, ch. 11, § 1, Schedule L, par. 390, 30 Stat. 187 (U. S. Comp. St. 1901, p. 1670).....	44
1887, Feb. 4, ch. 104, § 6, 24 Stat. 380 (U. S. Comp. St. 1901, p. 3156). Amended by Act 1906, June 29, ch. 3591, § 2, 34 Stat. 586 (U. S. Comp. St. Supp. 1907, p. 895).....	638	1897, July 24, ch. 11, § 1, Schedule M, par. 403, 30 Stat. 189 (U. S. Comp. St. 1901, p. 1673).....	1021
1887, Feb. 4, ch. 104, §§ 15, 16, 24 Stat. 384 (U. S. Comp. St. 1901, p. 3165). Amended by Act 1906, June 29, ch. 3591, §§ 4, 5, 34 Stat. 589, 590 (U. S. Comp. St. Supp. 1907, pp. 900, 902).....	638, 645	1897, July 24, ch. 11, § 1, Schedule N, par. 439, 30 Stat. 192 (U. S. Comp. St. 1901, p. 1676).....	905
1887, March 3, ch. 373, 24 Stat. 552.....	290	1897, July 24, ch. 11, § 1, Schedule N, par. 463, 30 Stat. 194 (U. S. Comp. St. 1901, p. 1679).....	205
1887, March 3, ch. 373, § 1, 24 Stat. 552.....	358	1897, July 24, ch. 11, § 2, Free List, par. 614, 30 Stat. 199 (U. S. Comp. St. 1901, p. 1685).....	205
1888, Aug. 13, ch. 866, 25 Stat. 443 (U. S. Comp. St. 1901, p. 508).....	290	1897, July 24, ch. 11, § 6, 30 Stat. 205 (U. S. Comp. St. 1901, p. 1693).....	65, 205, 907
1888, Aug. 13, ch. 866, § 1, 25 Stat. 433 (U. S. Comp. St. 1901, p. 509).....	358	1897, July 24, ch. 11, § 7, 30 Stat. 205 (U. S. Comp. St. 1901, p. 1693).....	65
1888, Sept. 13, ch. 1015, §§ 9, 10, 25 Stat. 478 (U. S. Comp. St. 1901, p. 1316).....	654	1898, June 13, ch. 448, § 29, 30 Stat. 464 (U. S. Comp. St. 1901, p. 2307).....	161, 459
1888, Sept. 26, ch. 1039, 25 Stat. 496 (U. S. Comp. St. 1901, p. 2658).....	259	1898, June 13, ch. 448, § 29, 30 Stat. 464. Amended by Act 1901, March 2, ch. 806, § 10, 31 Stat. 946 (U. S. Comp. St. 1901, p. 2307); repealed by Act 1902, April 12, ch. 500, § 7, 32 Stat. 97 (U. S. Comp. St. Supp. 1907, p. 649).....	795
1889, March 2, ch. 393, 25 Stat. 873 (U. S. Comp. St. 1901, p. 3696).....	953	1898, June 13, ch. 448, § 30, 30 Stat. 465 (U. S. Comp. St. 1901, p. 2308).....	161
1890, June 10, ch. 407, § 3, 26 Stat. 131 (U. S. Comp. St. 1901, p. 1887).....	778	1898, June 13, ch. 448, § 30, 30 Stat. 465. Amended by Act 1901, March 2, ch. 806, § 11, 31 Stat. 948 (U. S. Comp. St. 1901, p. 2308); repealed by Act 1902, April 12, ch. 500, § 8, 32 Stat. 97 (U. S. Comp. St. Supp. 1907, p. 649).....	795
1890, June 10, ch. 407, § 9, 26 Stat. 135 (U. S. Comp. St. 1901, p. 1895).....	778	1898, July 1, ch. 541, 30 Stat. 544 (U. S. Comp. St. 1901, p. 3418).....	489
1890, June 10, ch. 407, § 14, 26 Stat. 137 (U. S. Comp. St. 1901, p. 1933).....	99	1898, July 1, ch. 541, § 1, subd. 15, 30 Stat. 545 (U. S. Comp. St. 1901, p. 3419).....	1007
1890, July 2, ch. 647, 26 Stat. 209 (U. S. Comp. St. 1901, p. 3200).....	803	1898, July 1, ch. 541, § 3a (4), 30 Stat. 546 (U. S. Comp. St. 1901, p. 3422). Amended by Act 1903, Feb. 5, ch. 487, § 2, 32 Stat. 797 (U. S. Comp. St. Supp. 1907, p. 1025).....	326, 823
1890, July 2, ch. 647, §§ 1, 2, 26 Stat. 209 (U. S. Comp. St. 1901, p. 3200).....	700	1898, July 1, ch. 541, § 5, 30 Stat. 548 (U. S. Comp. St. 1901, p. 3424).....	500
1891, March 3, ch. 561, §§ 18, 19, 26 Stat. 1095 (U. S. Comp. St. 1901, pp. 1570, 1571).....	496	1898, July 1, ch. 541, § 7, 30 Stat. 548 (U. S. Comp. St. 1901, p. 3424).....	440
1892, July 20, ch. 209, 27 Stat. 252 (U. S. Comp. St. 1901, p. 706).....	616	1898, July 1, ch. 541, § 23b, 30 Stat. 552 (U. S. Comp. St. 1901, p. 3431). Amended by Act 1903, Feb. 5, ch. 487, 32 Stat. 798 (U. S. Comp. St. Supp. 1907, p. 1028).....	415
1893, March 2, ch. 196, 27 Stat. 531 (U. S. Comp. St. 1901, p. 3174). Amended by Act 1896, April 1, ch. 87, 29 Stat. 85; Act 1903, March 2, ch. 976, 32 Stat. 943 (U. S. Comp. St. Supp. 1907, p. 885).....	347	1898, July 1, ch. 541, § 24b, 30 Stat. 553 (U. S. Comp. St. 1901, p. 3432).....	311, 823
1894, Aug. 13, ch. 282, 28 Stat. 279 (U. S. Comp. St. 1901, p. 2315).....	631	1898, July 1, ch. 541, § 25a (3), 30 Stat. 553 (U. S. Comp. St. 1901, p. 3432).....	311
1894, Aug. 13, ch. 299, § 4, 28 Stat. 362 (U. S. Comp. St. 1901, p. 3525).....	269		
1895, Feb. 26, ch. 133, 28 Stat. 627 (U. S. Comp. St. 1901, p. 1519).....	434		
1896, April 1, ch. 87, 29 Stat. 85.....	347		
1897, March 3, ch. 391, § 5, 29 Stat. 692 (U. S. Comp. St. 1901, p. 3387).....	47		
1897, July 24, ch. 11, § 1, Schedule C, pars. 124, 183, 193, 30 Stat. 159, 166, 167 (U. S. Comp. St. 1901, pp. 1636, 1645).....	155		

1898, July 1, ch. 541, §§ 41a (4), 41b, 30 Stat. 556 (U. S. Comp. St. 1901, p. 3437) 71
 1898, July 1, ch. 541, § 63a (1), 30 Stat. 562 (U. S. Comp. St. 1901, p. 3447) 482, 673
 1898, July 1, ch. 541, § 64b (4), 30 Stat. 563 (U. S. Comp. St. 1901, p. 3447) 515
 1898, July 1, ch. 541, § 64b (5), 30 Stat. 563 (U. S. Comp. St. 1901, p. 3448) 482
 1898, July 1, ch. 541, §§ 67a, 67b, 30 Stat. 564 (U. S. Comp. St. 1901, p. 3449) 553
 1898, July 1, ch. 541, § 70e, 30 Stat. 566 (U. S. Comp. St. 1901, p. 3452) 618
 1900, June 5, ch. 786, 31 Stat. 395 529
 1901, March 2, ch. 806, §§ 10, 11, 31 Stat. 946, 948 (U. S. Comp. St. 1901, pp. 2307, 2308) 795
 1902, April 12, ch. 500, §§ 7, 8, 32 Stat. 97 (U. S. Comp. St. Supp. 1907, p. 649) 795
 1902, June 27, ch. 1160, § 3, 32 Stat. 406 (U. S. Comp. St. Supp. 1907, p. 652) 161, 459, 795
 1902, July 1, ch. 1356, 32 Stat. 631 665
 1903, Feb. 5, ch. 487, 32 Stat. 798 (U. S. Comp. St. Supp. 1907, p. 1028) 415
 1903, Feb. 5, ch. 487, § 2, 32 Stat. 797 (U. S. Comp. St. Supp. 1907, p. 1025) 326, 823
 1903, Feb. 19, ch. 708, § 1, 32 Stat. 847 (U. S. Comp. St. Supp. 1907, p. 880) 376
 1903, March 2, ch. 976, 32 Stat. 943 (U. S. Comp. St. Supp. 1907, p. 885) 347
 1906, April 26, ch. 1875, 34 Stat. 137 (U. S. Comp. St. Supp. 1907, p. 867) 670
 1906, June 11, ch. 3073, 34 Stat. 232 (U. S. Comp. St. Supp. 1907, p. 891) 347
 1906, June 29, ch. 3591, 34 Stat. 584 (U. S. Comp. St. Supp. 1907, p. 892) 215
 1906, June 29, ch. 3591, § 1, 34 Stat. 584 (U. S. Comp. St. Supp. 1907, p. 892) 75
 1906, June 29, ch. 3591, § 2, 34 Stat. 586 (U. S. Comp. St. Supp. 1907, p. 895) 638
 1906, June 29, ch. 3591, §§ 4, 5, 34 Stat. 589 (U. S. Comp. St. Supp. 1907, pp. 900, 902) 638, 645
 1906, June 29, ch. 3592, § 4, subd. 4, 34 Stat. 596 (U. S. Comp. St. Supp. 1907, p. 422) 335
 1906, June 29, ch. 3594, § 1, 34 Stat. 607 (U. S. Comp. St. Supp. 1907, p. 918) 400
 1907, Feb. 20, ch. 1134, 34 Stat. 898 (U. S. Comp. St. Supp. 1907, p. 391) 506
 1907, Feb. 20, ch. 1134, § 25, 34 Stat. 906 (U. S. Comp. St. Supp. 1907, p. 405) 152
 1908, April 22, ch. 149, 35 Stat. 65 698

REVISED STATUTES.

§ 629 (U. S. Comp. St. 1901, p. 503) 60
 § 649 (U. S. Comp. St. 1901, p. 525) 650
 § 716 (U. S. Comp. St. 1901, p. 580) 781
 § 720 (U. S. Comp. St. 1901, p. 581) 1
 § 754 (U. S. Comp. St. 1901, p. 593) 152
 § 892 (U. S. Comp. St. 1901, p. 673) 47
 § 914 (U. S. Comp. St. 1901, p. 684) 79
 § 2165 (U. S. Comp. St. 1901, p. 1329) 45
 §§ 2330, 2331 (U. S. Comp. St. 1901, p. 1432) 529
 §§ 2339, 2340 (U. S. Comp. St. 1901, p. 1437) 496
 § 2865 (U. S. Comp. St. 1901, p. 1905) 778
 § 3324 (U. S. Comp. St. 1901, p. 2168) 520

§ 3893. Amended by Act 1876. July 12, ch. 186, 19 Stat. 90; Act 1888, Sept. 26, ch. 1039, 25 Stat. 496 (U. S. Comp. St. 1901, p. 2658) 259
 § 4898. Amended by Act 1897, March 3, ch. 391, § 5, 29 Stat. 692 (U. S. Comp. St. 1901, p. 3387) 47
 § 4965 (U. S. Comp. St. 1901, p. 3414) 781
 §§ 5263-5268 (U. S. Comp. St. 1901, pp. 3579-3581) 561
 § 5270 (U. S. Comp. St. 1901, p. 3591) 783
 § 5440 (U. S. Comp. St. 1901, p. 3676) 75, 157, 524
 § 5444 (U. S. Comp. St. 1901, p. 3677) 584
 § 5445 (U. S. Comp. St. 1901, p. 3678) 587
 § 5480 (U. S. Comp. St. 1901, p. 3696) 894
 § 5480. Amended by Act 1889, March 2, ch. 393, 25 Stat. 873 (U. S. Comp. St. 1901, p. 3696) 953

COMPILED STATUTES 1901.

Page 503 60
 Page 508 290
 Page 509 358
 Page 525 650
 Page 580 781
 Page 581 1
 Page 593 152
 Page 673 47
 Page 684 79
 Page 706 616
 Page 1316 654
 Page 1393 913
 Page 1432 529
 Page 1437 496
 Page 1519 437
 Pages 1570, 1571 496
 Page 1629 45
 Pages 1636, 1645 155
 Page 1651 910
 Page 1652 907
 Page 1655 65
 Page 1662 285
 Page 1669 912
 Page 1670 44
 Page 1673 1021
 Page 1676 905
 Pages 1679, 1685 205
 Page 1693 65, 205, 907
 Page 1887 778
 Page 1895 580, 778
 Page 1905 778
 Page 1933 99
 Page 2168 520
 Page 2230 772
 Page 2307 161, 459, 795
 Page 2308 161, 795
 Page 2315 631
 Page 2658 259
 Page 3154 215
 Page 3165 645
 Page 3174 347
 Page 3200 700, 803
 Page 3387 47
 Page 3414 781
 Page 3418 489
 Page 3419 1007
 Page 3422 326, 823
 Page 3424 440, 509
 Page 3431 415
 Page 3432 311, 823

Page 3437..... 71
 Page 3447..... 482, 515, 673
 Page 3448..... 482
 Page 3449..... 553
 Page 3452..... 618
 Page 3458..... 830
 Page 3525..... 269
 Pages 3579-3581..... 561
 Page 3591..... 783
 Page 3676..... 75, 157, 524
 Page 3677..... 584
 Page 3678..... 587
 Page 3696..... 894, 953
 Pages 3756, 3765..... 638

COMPILED STATUTES SUPP. 1907.

Page 391..... 506
 Page 405..... 152
 Page 422..... 335
 Page 649..... 795
 Page 652..... 161, 459, 795
 Page 867..... 670
 Page 880..... 376
 Pages 885, 891..... 347
 Page 892..... 75
 Page 894..... 215
 Page 895..... 638
 Pages 900, 902..... 638, 645
 Page 918..... 400
 Page 1025..... 326, 823
 Page 1028..... 415

TREATIES.

With Chickasaw Indians, Jan. 17, 1837, 11
 Stat. 573..... 670
 With Choctaw Indians, Sept. 27, 1830, 7
 Stat. 333..... 670
 With Italy, March 23, 1868, art. 2, § 7, 15
 Stat. 630..... 288

ALASKA.

CODE OF CIVIL PROCEDURE.

§ 378..... 529

ARKANSAS.

MANSFIELD'S DIGEST.

§ 4491..... 963

KIRBY'S DIGEST.

§ 5060..... 963

CALIFORNIA.

CONSTITUTION.

Art. 12, § 3..... 673, 680

CIVIL CODE.

§ 322..... 680
 § 536..... 561
 § 1439..... 421
 § 2628..... 404

CODE OF CIVIL PROCEDURE.

§ 359..... 680
 § 377..... 263
 § 438..... 978

LAWS.

1905, p. 491, ch. 385..... 561
 1905, p. 777, ch. 578..... 561

COLORADO.

CONSTITUTION.

Art. 5, § 22..... 180

MILLS' ANNOTATED STATUTES.

Volume 1.

§§ 1054, 1055, 1719..... 970

LAWS.

1901, p. 161, ch. 67..... 180

FLORIDA.

LAWS.

1907, pp. 13, 14, ch. 5596, §§ 22, 23..... 759

KANSAS.

CONSTITUTION.

Art. 2, § 17..... 738
 Art. 12, §§ 1, 5..... 738

LAWS.

1908, p. 30, ch. 33..... 728, 738

KENTUCKY.

STATUTES 1903.

§ 655..... 526

MISSOURI.

REVISED STATUTES 1899.

§ 4262 (Ann. St. 1906, p. 2335)..... 318

ANNOTATED STATUTES 1906.

§ 4262..... 318

NEVADA.

CUTTING'S COMPILED LAWS.

§ 2708..... 397

NEW YORK.

CODE OF CIVIL PROCEDURE.

§ 1391, Amended by Laws 1908, p. 433,
 ch. 148..... 883

LAWS.

1908, p. 433, ch. 148..... 883

PENNSYLVANIA.

LAWS.

1827, p. 129..... 281
 1836, p. 777, § 83..... 482
 1887, p. 289..... 281

1901, pp. 206, 209, §§ 80, 115..... 296
 1903, p. 139..... 281

SOUTH CAROLINA.

CIVIL CODE 1902.
 § 2456..... 300

LAWS.

1907, pp. 463, 835..... 1

WASHINGTON.

CONSTITUTION.

Art. 17, § 1..... 604

STREET RAILROADS.

See Railroads.

§ 1. Regulation and operation.

Where a pedestrian is injured in a collision with a street car, and both parties are negligent, there is no right of recovery.—*Denver City Tramway Co. v. Cobb* (C. C. A.) 41.

*A pedestrian, about to cross a street railroad, should look along the tracks to ascertain whether a car is approaching, and do so at a place and time when it will be effectual for his protection.—*Denver City Tramway Co. v. Cobb* (C. C. A.) 41.

*The last chance doctrine does not apply where there is no negligence of defendant supervening subsequently to that of plaintiff, or where his negligence or position of danger is not discovered by defendant in time to avoid the injury.—*Denver City Tramway Co. v. Cobb* (C. C. A.) 41.

STREETS.

Right of telegraph or telephone company in street, see Telegraphs and Telephones, § 1.

SUA SPONTE.

Determination of questions of jurisdiction on court's own motion on appeal to United States circuit court of appeals, see Courts, § 2.

SUBROGATION.

Of trustee in bankruptcy to rights under lien, see Bankruptcy, § 4.

SUBSTITUTED SERVICE.

See Process, § 2.

SUMMONS.

See Process.

TARIFF.

See Customs Duties.

TAXATION.

See Customs Duties; Internal Revenue.
 Construction of laws relating to, see Statutes, § 3.

Deprivation of property without due process of law, see Constitutional Law, § 2.

Due process of law, see Constitutional Law, § 2.

§ 1. Nature and extent of power in general.

§ 4. It is within the power of the Legislature of a state to provide for the assessment and taxation for past years of property which has escaped taxation for such years.—*Jackson Lumber Co. v. McCrimmon* (C. C.) 759.

§ 2. Levy and assessment.

§ 309. The word "assessment," as used in tax statutes, does not mean merely the valuation of the property for taxation, but includes the whole statutory mode of imposing the tax, embracing all of the proceedings for raising money by the exercise of the power of taxation from their inception to their conclusion.—*Jackson Lumber Co. v. McCrimmon* (C. C.) 759.

§ 317. The validity of an assessment made by an assessor is not affected by the fact that he is compensated by a commission on the amount of the taxes levied.—*Jackson Lumber Co. v. McCrimmon* (C. C.) 759.

§ 3. Lien and priority.

§ 508. The time when a tax becomes due and payable under a statute does not necessarily fix the time when it becomes a lien.—*Westhus v. Union Trust Co. of St. Louis* (C. C. A.) 795.

§ 4. Collection and enforcement against persons or personal property.

§ 608. A mere irregularity in an assessment or the fact that the tax is excessive will not authorize a court of equity to enjoin its collection.—*Jackson Lumber Co. v. McCrimmon* (C. C.) 759.

§ 608. The federal courts will not grant relief by injunction against the collection of taxes imposed on the property of foreign corporations because of the methods adopted by the tax officers in arriving at the valuation of the property, unless fraud is shown, or it is obvious that a wrong principle has been adopted.—*Jackson Lumber Co. v. McCrimmon* (C. C.) 759.

TELEGRAPHS AND TELEPHONES.

§ 1. Establishment, construction, and maintenance.

§ 10. The finding of a master that a charge by a city of \$3 per pole as rental for the occupancy and use of its streets by telegraph companies was reasonable held sustained by the evidence.—*City of Memphis v. Postal Telegraph & Cable Co.* (C. C. A.) 600.

§ 4. The California franchise act of March 22, 1905 (St. 1905, p. 777, c. 578), repealed by implication Civ. Code, § 536, as re-enacted March 20, 1905 (St. 1905, p. 491, c. 385), giving the right to telegraph and telephone companies to construct their lines on any public road or

*Point annotated. See syllabus.

highway, except as to such lines doing an interstate business.—Sunset Telephone & Telegraph Co. v. City of Pomona (C. C.) 561.

§ 9. A telephone company is not within Act July 24, 1866, c. 230, 14 Stat. 221 (Rev. St. §§ 5263-5268; U. S. Comp. St. 1901, pp. 3579-3581), granting to telegraph companies who accept its conditions the right to construct their lines over the public lands and post roads; nor can a company doing both a telegraph and telephone business claim its benefit as to the lines used in its telephone business.—Sunset Telephone & Telegraph Co. v. City of Pomona (C. C.) 561.

§ 10. Act July 24, 1866, c. 230, 14 Stat. 221 (Rev. St. §§ 5263-5268; U. S. Comp. St. 1901, pp. 3579-3581), does not grant to telegraph companies the right to occupy with their poles, and wires the streets of a city without the latter's consent.—Sunset Telephone & Telegraph Co. v. City of Pomona (C. C.) 561.

§ 10. A telephone company, which unlawfully occupies the streets of a city with its poles and wires after its franchise to do so has expired, and which has refused the demand of the city that it renew the same, is not entitled to relief in equity because the removal of such poles and wires as obstructions to the streets was ordered by a resolution, rather than by ordinance, or was otherwise informal.—Sunset Telephone & Telegraph Co. v. City of Pomona (C. C.) 561.

§ 10. In Civ. Code Cal. § 536, which as it existed prior to its re-enactment March 20, 1905, (St. 1905, p. 491, c. 385), granted the right to telegraph corporations to construct their lines along and upon any public road or highway, the words "telegraph corporations" do not include a telephone company.—Sunset Telephone & Telegraph Co. v. City of Pomona (C. C.) 561.

§ 10. In Civ. Code Cal. § 536, which as re-enacted March 20, 1905 (St. 1905, p. 491, c. 385), grants to both telegraph and telephone companies the right to construct their lines "along and upon any public road or highway," the word "highway" includes a street.—Sunset Telephone & Telegraph Co. v. City of Pomona (C. C.) 561.

TENDER.

As condition precedent to action for breach of contract of sale, see Sales, § 3.

TERMINAL CHARGES.

For transportation of live stock, see Carriers, § 1.

TIME.

For particular acts in or incidental to judicial proceedings.

Application for new trial in criminal prosecution, see Criminal Law, § 3.

Filing bond of costs on appeal, see Appeal and Error, § 2.

Vacation of judgment in criminal prosecution, see Criminal Law, § 4.

For particular acts not judicial.

Performance of contract, see Contracts, § 2.

TITLE.

Color of title, see Adverse Possession.

Of trustee in bankruptcy, see Bankruptcy, § 3.

To patent, see Patents, § 5.

TOBACCO TRUST.

See Monopolies, § 1.

TORTS.

Liabilities of particular classes of persons.

Employés, see Master and Servant, § 2.

Vessel owners, see Shipping, § 1.

Particular torts.

See Conspiracy, § 1; Negligence; Trover and Conversion.

TOWAGE.

As salvage service, see Salvage, § 1.

*The duty of a tug to a tow is a continuous one from the time the service commences until it is completed, and where it becomes necessary to anchor the tow the tug's obligation of reasonable care continues, at least until she is safely anchored.—The Printer (C. C. A.) 314.

A tug, which undertook to tow a schooner from Gray's Harbor to sea, held in fault for her loss, where the tug left her for the night to await a favorable tide for crossing the bar without waiting to see that she was securely anchored, and by reason of the breaking of her anchor chains as soon as they were subject to strain she drifted upon the bar and was wrecked. The schooner also held in fault because of her defective anchor chains.—The Printer (C. C. A.) 314.

§ 15. Evidence considered, and held not to sustain the allegation of a libel that the sinking of a coal barge while in tow on a hawser was due to the fault of the tug in towing her on a rock, but to show that it was the result of tempestuous weather which caused a collision between such barge and another tow.—The Pottsville (D. C.) 447.

TOWNS.

Construction of contract with, see Contracts, § 2.

TRADE-MARKS AND TRADE-NAMES.

§ 1. Marks and names subjects of ownership.

The purchaser under an order of a French court of the property, good will, and trademark rights of the Carthusian monks connected

*Point annotated. See syllabus.

with the manufacture and sale of the liqueur well known and sold under the name of "Chartreuse" held not entitled to use on the bottles containing the liqueur manufactured by it the labels formerly used by the monks.—*Baglin v. Cusenier Co.* (C. C. A.) 25.

§ 2. Infringement and unfair competition.

§ 92. A bill for unfair competition in trade by the use by defendant of a name for a periodical similar to one used by complainant must clearly allege that it was so used with intent to deceive the public or patrons, and an allegation that it was "calculated to deceive" is insufficient.—*Industrial Press v. W. R. C. Smith Pub. Co.* (C. C. A.) 842.

The manufacturer of an antiseptic, to which he gave the artificial name "Argyrol," held entitled to an injunction restraining defendant, a jobbing druggist, from placing Argyrol on his price list and supplying customers who called for the same with a different and cheaper preparation in its place.—*Barnes v. Pierce* (C. C.) 213.

§ 65. A defendant held on the evidence not chargeable with infringement of a trade-mark.—*H. Mueller Mfg. Co. v. A. Y. McDonaly & Morrison Mfg. Co.* (C. C.) 1001.

§ 75. A defendant manufacturing stop and waste cocks and similar plumbers' supplies which procured such articles of complainant's manufacture and purposely imitated them in size, shape, and appearance, thereby causing confusion in the trade and in fact deceiving purchasers, held chargeable with unfair competition which entitled the complainant to an injunction.—*H. Mueller Mfg. Co. v. A. Y. McDonaly & Morrison Mfg. Co.* (C. C.) 1001.

TRADE-MARKS AND TRADE-NAMES ADJUDICATED.

- "Argyrol."—*Barnes v. Pierce*..... 213
- "Chartreuse."—*Baglin v. Cusenier Co.*.... 25

TREATIES.

See Extradition, § 1.

TRIAL.

See Witnesses.

Appealability of order striking case from docket, see Appeal and Error, § 1.

Harmless error in instructions, see Appeal and Error, § 4.

Proceedings incident to trials.

Conformity of judgment to verdict or findings, see Judgment.

Entry of judgment after trial of issues, see Judgment, § 2.

Right to trial by jury, see Jury, § 1.

Trial of particular civil actions or proceedings.

See Negligence, § 2.

For alienation of affections, see Husband and Wife, § 1.

For death caused by operation of railroad, see Railroads, § 2.

For death of passenger, see Carriers, § 4.

For injuries to tow, see Towage.

For personal injuries, see Railroads, § 2.

Trial of criminal prosecutions.

See Criminal Law, § 2.

For offenses against postal laws, see Post Office, § 2.

§ 1. Reception of evidence.

§ 105. Secondary evidence is nevertheless evidence to be considered, if not reasonably objected to.—*Loew Filter Co. v. German-American Filter Co. of New York* (C. C. A.) 855.

§ 2. Taking case or question from jury.

Where the evidence is undisputed, or so clearly preponderant that the court could give effect to but one judgment, a verdict should be directed.—*Robinson v. Denver City Tramway Co.* (C. C. A.) 174.

§ 141. Where the evidence is undisputed, or clearly preponderates, the disposition of the case on the evidence is for the court.—*Bell v. Carter* (C. C. A.) 417.

§ 3. Instructions to jury.

§ 237. A requested instruction in an action based on negligence that the negligence of defendant must be "absolutely" shown to warrant a recovery was properly refused as stating an excessive measure of proof.—*Bolen-Darnall Coal Co. v. Williams* (C. C. A.) 665.

§ 242. Instructions which taken as a whole are calculated to mislead the jury as to the character of the evidence necessary to prove the issue on one side as by failing to present with sufficient distinctness a material fact which may have a controlling effect are erroneous.—*Bolen-Darnall Coal Co. v. Williams* (C. C. A.) 665.

§ 253. Instructions in an action by a coal miner in Indian Territory to recover for a personal injury alleged to have been caused by the negligence of the mine owner in permitting dust to accumulate in the mine in violation of Act July 1, 1902, c. 1356, 32 Stat. 631, held misleading and erroneous as failing to present to the jury a material issue made by the evidence.—*Bolen-Darnall Coal Co. v. Williams* (C. C. A.) 665.

§ 4. Trial by court.

§ 388. In an action at law tried in a circuit court without a jury by stipulation under Rev. St. § 649 (U. S. Comp. St. 1901, p. 525), the defeated party is entitled to have the court make special findings of fact when it is doubtful under the decisions whether he could otherwise properly present to an appellate court the questions of law involved.—*Joline v. Metropolitan Securities Co.* (C. C.) 650.

*Point annotated. See syllabus.

TROVER AND CONVERSION.

§ 1. Acts constituting conversion and liability therefor.

§ 9. A sheriff, who takes from a prisoner property rightfully belonging to him and surrenders it to another, in disregard of the prisoner's rights and in recognition of an adverse claim asserted by another, is guilty of a conversion, and liable in trover without demand for its return.—Bell v. Carter (C. C. A.) 417.

TRUST DEEDS.

See Mortgages.

TRUSTS.

Combinations to monopolize trade, see Monopolies, § 1.

TUGS.

See Towsage.

UNFAIR COMPETITION.

See Trade-Marks and Trade-Names, § 2.

UNION DEPOTS.

Liability of carriers using station jointly for injuries to passengers, see Carriers, § 4.

UNITED STATES.

See Customs Duties; Post Office; Removal of Causes, § 1.

Conspiracy to defraud, see Conspiracy, § 2.

Courts, see Courts, §§ 2, 3.

Indians, see Indians.

Public lands, see Public Lands, § 1.

Regulation of canals, see Canals, § 1.

VENDOR AND PURCHASER.

See Sales.

Specific performance of contract, see Specific Performance.

§ 1. Requisites and validity of contract.

§ 16. A letter, written in answer to one containing an offer to sell land, held not to contain such an unconditional acceptance in the identical terms of the offer as to create a contract binding on the owner of the land.—Lacey v. Thomas (C. C.) 623.

VERDICT.

Directing verdict in civil actions, see Trial, § 2.
Review on appeal or writ of error, see Appeal and Error, § 4.

VERIFICATION.

Of invoices, see Customs Duties, § 3.

Of pleading, see Pleading, § 2.

VESTED RIGHTS.

Water rights in public lands, see Waters and Water Courses, § 1.

WAIVER.

Of objection to indictment or information, see Indictment and Information, § 3.

Of right to trial by jury, see Jury, § 1.

WARDS.

See Guardian and Ward.

WAREHOUSEMEN.

Warehouses for imported goods, see Customs Duties, § 3.

WARRANT.

In bankruptcy, see Bankruptcy, § 1.

WARRANTY.

On sale of goods, see Sales, § 4.

WAR REVENUE TAX.

See Internal Revenue.

WATERS AND WATER COURSES.

See Canals; Navigable Waters.

Act authorizing certain classes of cities to acquire waterworks property as special legislation, see Statutes, § 2.

Including land in reservoir basin and flooding same as constituting permanent obstruction to use justifying injunction, see Injunction, § 2.

§ 1. Appropriation of rights in public lands.

§ 12. Under Act March 3, 1891, c. 561, §§ 18, 19, 26 Stat. 1101, 1102 (U. S. Comp. St. 1901, pp. 1570, 1571), right of way for a reservoir over the public lands can only be acquired by the approval of the map thereof by the Secretary of the Interior.—United States v. Rickey Land & Cattle Co. (C. C.) 496.

§ 18. Vested rights in public lands to right of way for ditches, canals, or reservoirs for water purposes, under Rev. St. §§ 2339, 2340 (U. S. Comp. St. 1901, p. 1437), are not acquired until the actual completion of the work, so that the water can be applied to beneficial use.—United States v. Rickey Land & Cattle Co. (C. C.) 496.

§ 26. Appropriation of water under laws of California gives no right of way over public lands of the United States withdrawn after the appropriation and before filing of application for such right of way under Act March 3, 1891, c. 561, §§ 18, 19, 26 Stat. 1101, 1102 (U. S.

*Point annotated. See syllabus.

Comp. St. 1901, pp. 1570, 1571).—United States v. Rickey Land & Cattle Co. (C. C.) 496.

§ 2. Appropriation and prescription.

§ 151. An appropriator of water from a stream for mining purposes held not to have lost the right thereto by abandonment through failure to diligently prosecute the work of utilizing the same.—Thorndyke v. Alaska Perseverance Mining Co. (C. C. A.) 657.

WHARVES.

Construction of on navigable waters, see Navigable Waters, § 1.

§ 20. The lessee of a part of a wharf approached through an adjoining dock or slip held liable for an injury received by a barge which grounded on a shoal in such slip when moving to such wharf where he failed to advise the master of the danger, but on the contrary his agent assured the master that there was sufficient water.—The Joseph P. Tucker (D. C.) 746.

WILLS.

See Executors and Administrators.

War revenue taxes on legacies, see Internal Revenue.

WITHDRAWAL.

Of stockholders of national bank, see Banks and Banking, § 1.

WITNESSES.

See Evidence.

§ 1. Credibility, impeachment, contradiction, and corroboration.

§ 388. A written statement previously made by a witness is not admissible in evidence to contradict and impeach his testimony, unless it was called to his attention when on the stand.—Lemon v. United States (C. C. A.) 953.

WORDS AND PHRASES.

"Actionable combination."—In re Friedman (D. C.) 131.
 "Action hereafter brought."—Winfree v. Northern Pac. Ry. Co. (C. C.) 698.
 * "Actual value."—Lynch v. Union Trust Co. of San Francisco (C. C. A.) 161.
 "Aid in the illegal admission of imports."—United States v. Mescall (C. C.) 584.
 "Article used as coffee."—E. C. Hazard & Co. v. United States (C. C.) 907.
 "Assessment."—Jackson Lumber Co. v. McCrimmon (C. C.) 759.
 "By or through."—Williamsburgh City Fire Ins. Co. of Brooklyn v. Willard (C. C. A.) 404.
 "Calculated to deceive."—Industrial Press v. W. R. C. Smith Pub. Co. (C. C. A.) 842.
 "Caused."—Williamsburgh City Fire Ins. Co. of Brooklyn v. Willard (C. C. A.) 404.

"Chutney."—Park & Tilford v. United States (C. C.) 910.

"Claim or right."—Troddick v. Northern Pac. Ry. Co. (C. C. A.) 913.

* "Clear value."—Lynch v. Union Trust Co. of San Francisco (C. C. A.) 161.

"Color of title."—United States v. Casterlin (C. C.) 437.

"Combination in restraint of interstate commerce."—United States v. American Tobacco Co. (C. C.) 700.

"Commencement of suit."—United States v. Miller (C. C.) 444; Same v. Robinson, Id.

* "Commerce."—United States v. Southern Ry. Co. (D. C.) 347.

"Connivance."—Woldson v. Larson (C. C. A.) 548.

* "Contempt."—In re Gitkin (D. C.) 71.

* "Court."—Murray v. Wilson Distilling Co. (C. C. A.) 1.

"Creditors."—In re Rice (D. C.) 589.

* "Defendant."—Illinois Cent. R. Co. v. A. Waller & Co. (C. C.) 358.

"Directly or indirectly."—Williamsburgh City Fire Ins. Co. of Brooklyn v. Willard (C. C. A.) 404.

* "Distributive share."—Lynch v. Union Trust Co. of San Francisco (C. C. A.) 161.

"Edible fruits prepared."—Park & Tilford v. United States (C. C.) 910.

"Effects."—United States v. Mescall (C. C.) 587.

"Entry."—United States v. Mescall (C. C.) 580, 584, 587.

"Every person."—United States v. Mescall (C. C.) 587.

"Fixed liability absolutely owing."—In re Pittsburg Drug Co. (D. C.) 482.

"Fruits preserved."—Park & Tilford v. United States (C. C.) 910.

"Governed by Illinois classification."—Standard Oil Co. of Indiana v. United States (C. C. A.) 376.

"Highway."—Sunset Telephone & Telegraph Co. v. City of Pomona (C. C.) 561.

"Imposed."—Westhus v. Union Trust Co. of St. Louis (C. C. A.) 795.

"Indispensable parties."—Mathieson v. Craven (C. C.) 471.

"Inlaid linoleum."—United States v. Scott & West (C. C.) 285.

* "Insolvency."—In re Golden Malt Cream Co. (C. C. A.) 326; National Chemical Co. v. Golden Malt Cream Co., Id.

"Interstate commerce."—United States v. American Tobacco Co. (C. C.) 700.

"Iron manufactured."—Harrison Supply Co. v. United States (C. C.) 155.

* "Legacy."—Lynch v. Union Trust Co. of San Francisco (C. C. A.) 161.

"Linoleum * * * figured or plain."—United States v. Scott & West (C. C.) 285.

* "Manufactured."—United States v. Graser-Rothe (C. C.) 205.

"Minerals crude."—United States v. Graser-Rothe (C. C.) 205.

"Necessary parties."—Mathieson v. Craven (C. C.) 471.

"Occasioned."—Williamsburgh City Fire Ins. Co. of Brooklyn v. Willard (C. C. A.) 404.

*Point annotated. See syllabus.

- "Other person."—United States v. Mescall (C. C.) 580.
- "Panne velvet."—United States v. Passavant & Co. (C. C.) 912.
- "Plank linoleum."—United States v. Scott & West (C. C.) 285.
- "Printed matter."—A. H. Ringk & Co. v. United States (C. C.) 1021.
- "Proceeding in bankruptcy."—In re Hecox (C. C. A.) 823; Hecox v. Rolleston, Id.
- "Railroad engaged in interstate commerce."—United States v. Southern Ry. Co. (D. C.) 347.
- "Regulation of interstate commerce."—United States v. Delaware & H. Co. (C. C.) 215.
- "Resided continuously."—In re Schneider (C. C.) 335.
- "Servant."—In re Caldwell (D. C.) 515.
- "Smuggle or clandestinely introduce."—United States v. 646 Half-Boxes of Figs (D. C.) 778; Same v. 82 Half-Boxes of Cheese, Id.
- "Specially excepted."—Williamsburgh City Fire Ins. Co. of Brooklyn v. Willard (C. C. A.) 404.
- "Substitute for coffee."—E. C. Hazard & Co. v. United States (C. C.) 907.
- "Telegraph corporations."—Sunset Telephone & Telegraph Co. v. City of Pomona (C. C.) 561.
- *"Thing."—United States v. Somers (D. C.) 259.
- "Transaction."—Standard Oil Co. of Indiana v. United States (C. C. A.) 376.
- *"Trimnings."—Naday & Fleischer v. United States (C. C. A.) 44.
- "Unenumerated manufactured article."—E. C. Hazard & Co. v. United States (C. C.) 907.
- "Unlawful monopoly."—United States v. American Tobacco Co. (C. C.) 700.
- *"Unwrought metals."—Harrison Supply Co. v. United States (C. C.) 155.
- "Vested legacy."—Title Guarantee & Trust Co. v. Ward (C. C.) 459.
- *"Waste."—United States v. Graser-Rothe (C. C.) 205.
- *"Weather working day."—Pyman S. S. Co. v. One Hundred Tons of Kainit (D. C.) 364.

WRIT OF SEIZURE.

In action for infringement of copyright, see Copyrights, § 2.

WRITS.

See Process.

Particular writs.

See Habeas Corpus; Mandamus.

Of seizure, as preliminary to action for penalty under copyright law, see Copyrights, § 2.

Writ of error, see Appeal and Error.

WRONGFUL SEIZURE.

See Taxation, § 4.

*Point annotated. See syllabus.

