

ROUTE MARKER SIGNS FOR NATIONAL HIGHWAYS

(First Revision)



THE INDIAN ROADS CONGRESS

1985

**ROUTE MARKER SIGNS
FOR
NATIONAL HIGHWAYS**

(First Revision)

Published by

THE INDIAN ROADS CONGRESS

Jamnagar House, Shahjahan Road,

New Delhi-110 011

1985

Price Rs 80/-
(Plus packing & postage)

IRC : 2-1968

First published : December, 1953

First Revision : December, 1968

Reprinted : July 1985

Reprinted : October, 2009

(Rights of Publication and of Translation are Reserved)

ROUTE MARKER SIGNS FOR NATIONAL HIGHWAYS

1. INTRODUCTION

1.1. Planting of route marker signs along National Highways is considered advantageous for more than one reason. Type designs for National Highway route marker were developed initially in the Roads Wing of the Ministry of Transport, Government of India and discussed at the Chief Engineers' meeting held in April 1952. The design finalised in light of these discussions was issued by the Consulting Engineer (Road Development) to the Government of India for general adoption and also published as an Indian Roads Congress Standard in 1953.

1.2. Consequent upon switchover to metric system in the country, it became imperative to metricise the Standard. The metricisation was initially considered by a Subcommittee of the Indian Roads Congress dealing with matters concerning roads. Later on, it was examined by the Specifications and Standards Committee (personnel given on inside front cover) along with a general revision of the Standard at its meetings held in 1967. Besides rationalisation of the various dimensions and values into metric units, certain other important changes have also been incorporated in this revised edition which was approved by the Executive Committee at their meeting held on 24th September, 1968 and finally by the Council at their meeting held at Bombay on 2nd November, 1968.

2. DESIGN

2.1. A National Highway route marker sign shall consist of a shield painted on a rectangular plate 450 mm by 600 mm. The design is given in Plate 1.

2.2. The sign shall have a yellow background and the lettering and border shall be in black. The yellow colour shall conform to "Canary Yellow, Indian Standard Colour No. 309". Materials of the paint shall be in accordance with the requirements specified by the Indian Standards Institution.

2.3. The size, shape and spacing of the letters and numerals shall conform to those given in Fig. 1 and Plates 1 and 5.

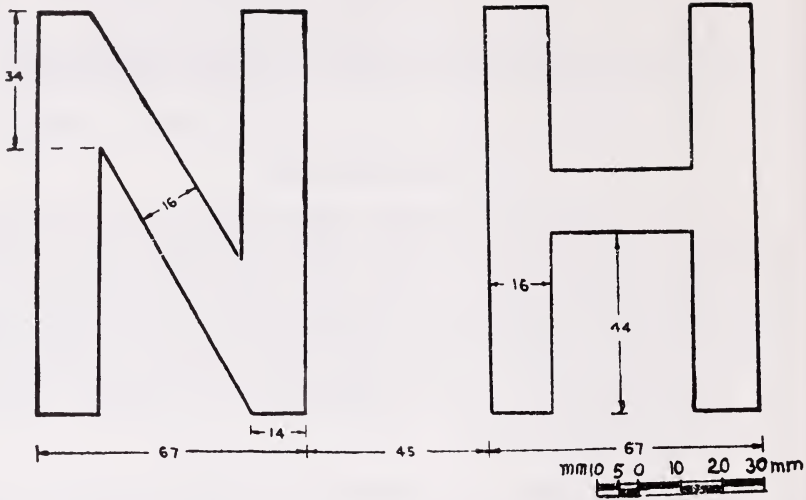

Fig.1: STANDARD LETTERS N AND H OF 100 mm HEIGHT
(All dimensions are in millimetres)

3. LOCATION

3.1. The sign shall be erected on National Highways ahead of their intersections with other important roads, immediately after the intersections as confirmatory route markers, at suitable locations through built-up areas, and at such other points that may be considered necessary to guide the through traffic.

3.2. The sign shall be erected as indicated in the drawing titled "Arrangement for Erection of National Highway Route Marker Signs", Plate 2.

3.3. On roads without kerbs, the sign shall be erected with a clear distance of 2 to 3 metres between the post and the edge of the carriageway. On roads with kerbs, the sign post shall not be less than 60 mm away from the edge of the kerb. To avoid specular reflection from the sign face, the sign shall be turned slightly away from the road as indicated in Plate 2.

3.4. The distance (along the National Highway) of the sign from the junction, on either side of it, shall be 100 to 150 metres. Also, it shall be fixed on the left hand side as one approaches the junction.

4. DEFINITION PLATE

4.1. When the sign is erected in advance of a junction, the direction which the National Highway takes at the junction shall be indicated on a definition plate of the size 300 mm by 250 mm fixed below the shield as shown in Plate 2.

4.2. Background colour of the definition plate shall be the same as of the shield (Clause 2.2.). The border and arrow shall be in black.

4.3. Some type designs of arrows for use on the definition plate in different situations are given in Plate 3.

5. ROUTE MARKER ASSEMBLY AT JUNCTIONS WITH NUMBERED ROUTES

5.1. When a numbered route intersects or takes off from a National Highway, indication about the number of the intersecting route may be provided by erecting, ahead of the intersection, its route marker sign along with the marker of the National Highway route being travelled upon. Such auxiliary markers shall be mounted on the same post as carrying the regular route marker and be accompanied by a definition plate carrying a single or a double-headed arrow pointing in the general direction or directions in which that route may be followed.

5.2. The manner of putting up such assemblies is illustrated through two examples given in Plate 4.

6. COLOUR OF BACK OF SIGN AND POST

Similar to other traffic signs, the reverse side of all route marker signs should be painted in unobtrusive grey, Indian Standard Colour No. 630. The sign post should be painted in 25 cm bands, alternately black and white, with the lowest band next to the ground being black.

7. MATERIALS

The sign may be of either enamelled or painted steel plate.



Digitized by the Internet Archive
in 2014

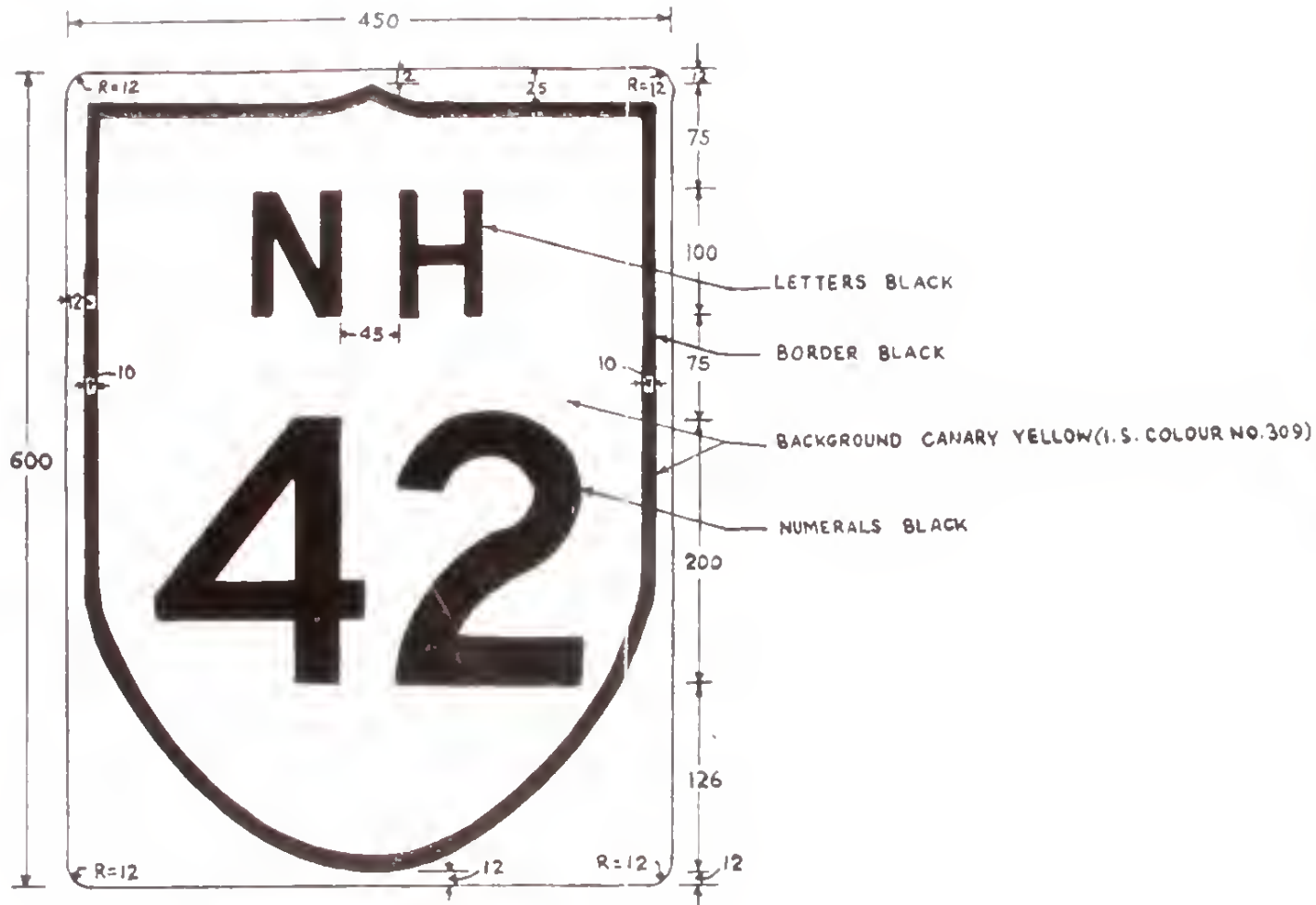

mm 30 150 30 60 90 120 150 180 210 mm

All dimensions are in millimetres

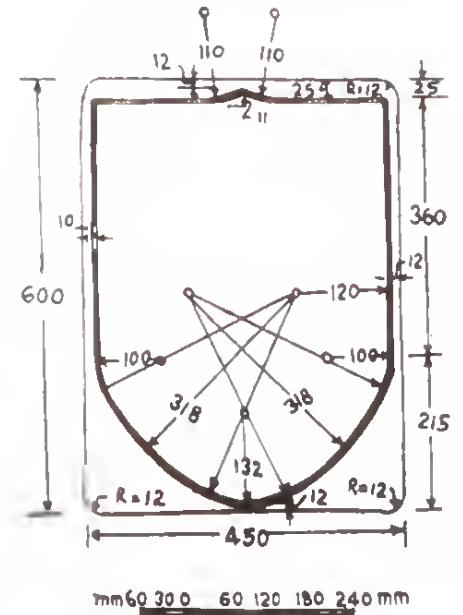

NATIONAL HIGHWAY
ROUTE MARKER SIGN

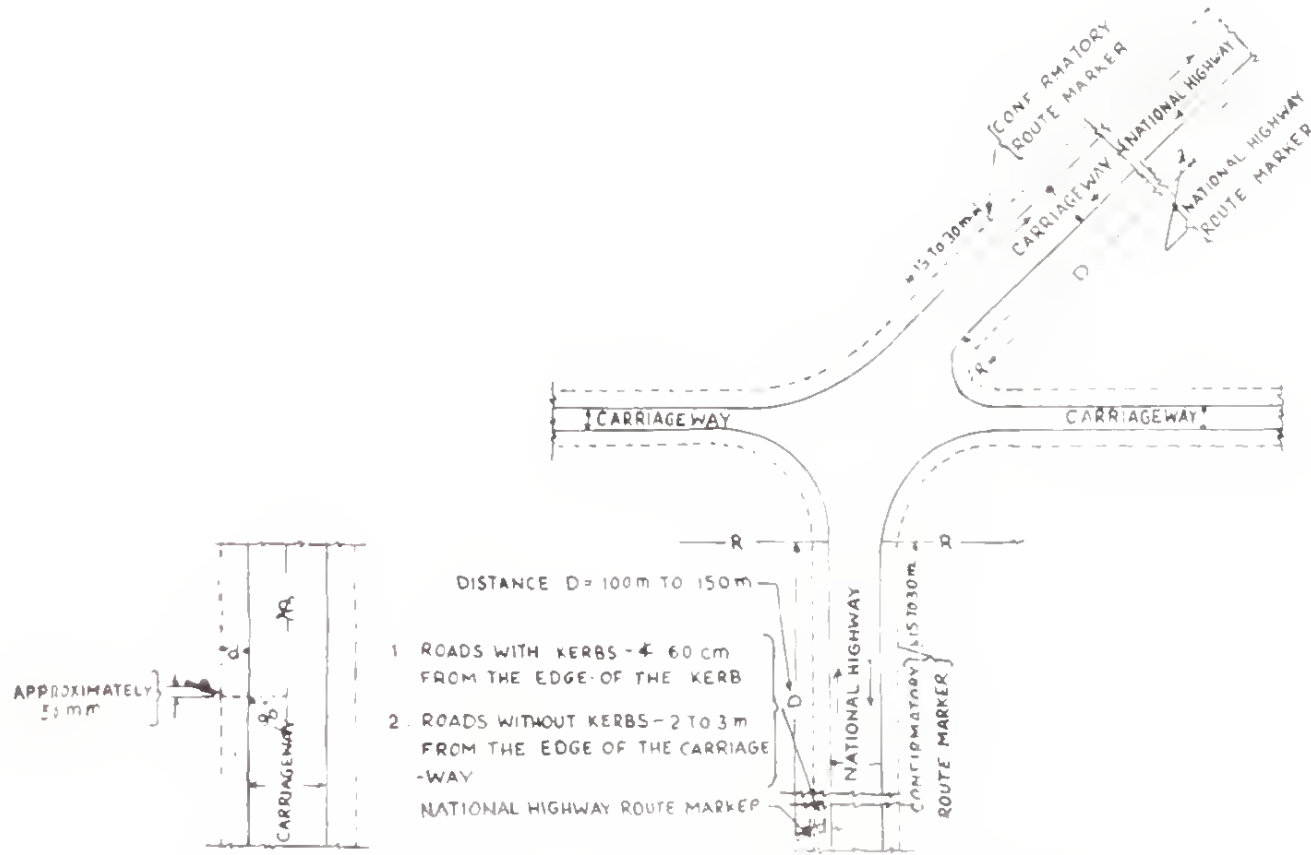

POSITIONING OF THE SIGN

PLAN SHOWING LOCATION OF ROUTE MARKER SIGN AT A JUNCTION

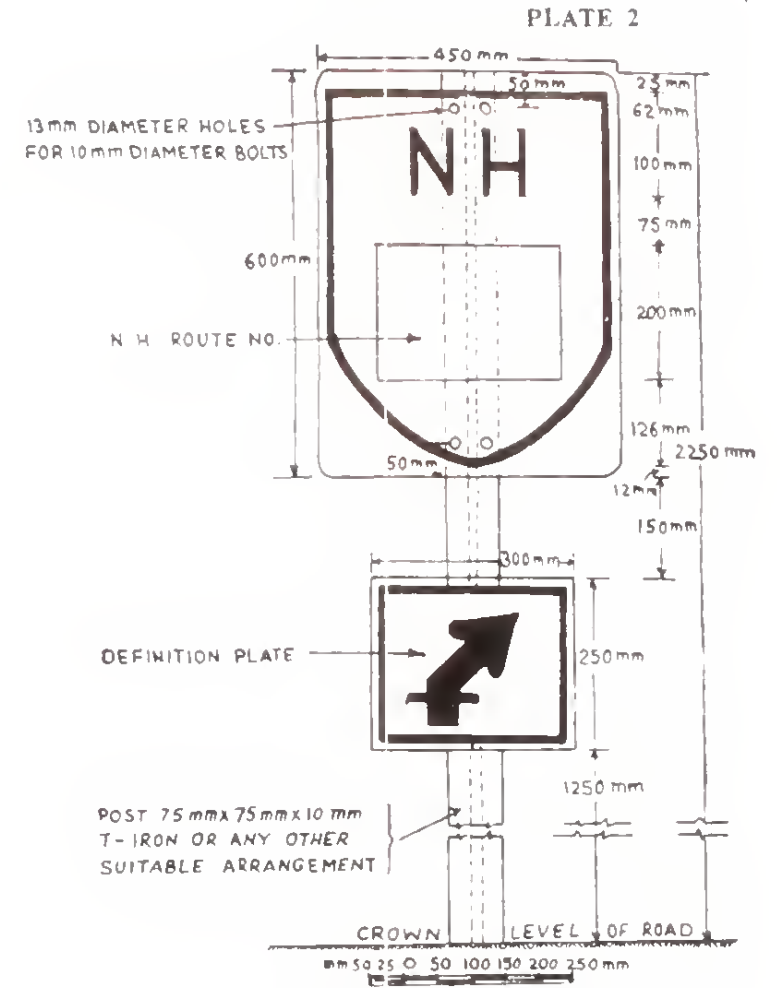

ASSEMBLY OF ROUTE MARKER SIGN

ARRANGEMENT FOR ERECTION OF NATIONAL HIGHWAY ROUTE MARKER SIGN

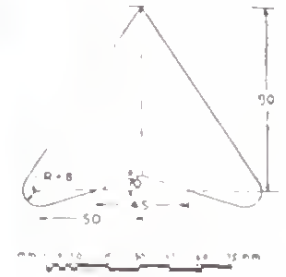
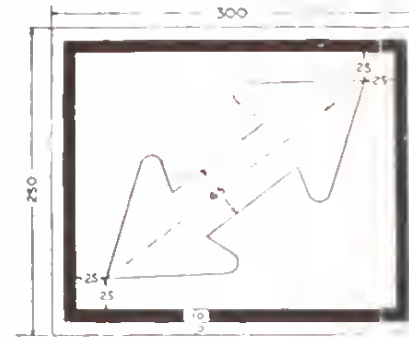
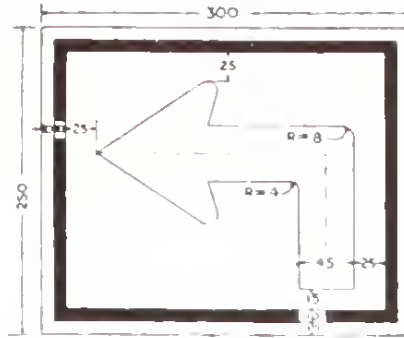
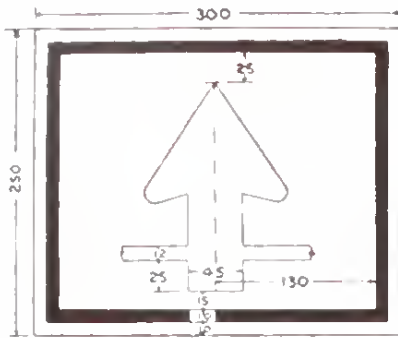

DETAILS OF ARROWHEAD

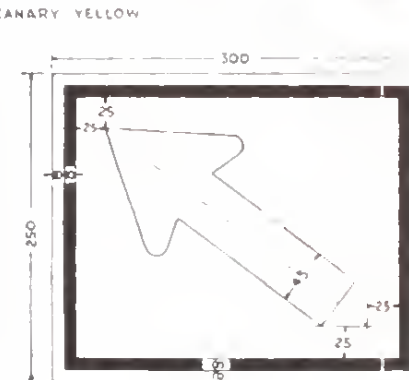
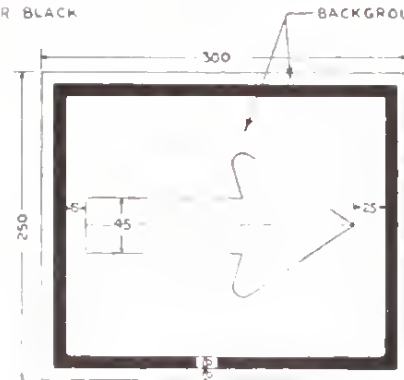
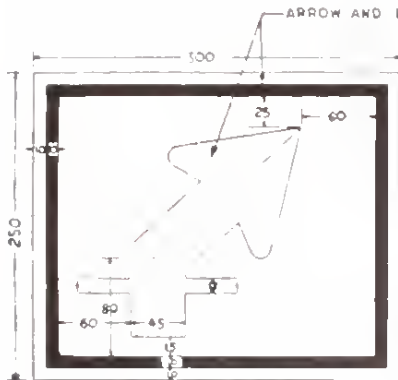

NOTES

1. ALL DIMENSIONS ARE IN MILLIMETRES
2. BACKGROUND COLOUR SHALL BE CANARY YELLOW (IS COLOUR NO. 39) AND THE BORDER AND ARROW IN BLACK
3. ARROWS GIVEN IN THIS PLATE ARE ONLY EXAMPLES FOR OTHER SITUATIONS, ARROWS COULD BE SUITABLY EVOLVED ON SIMILAR LINES.

DETAILS OF TYPICAL ARROWS FOR USE ON THE DEFINITION PLATE

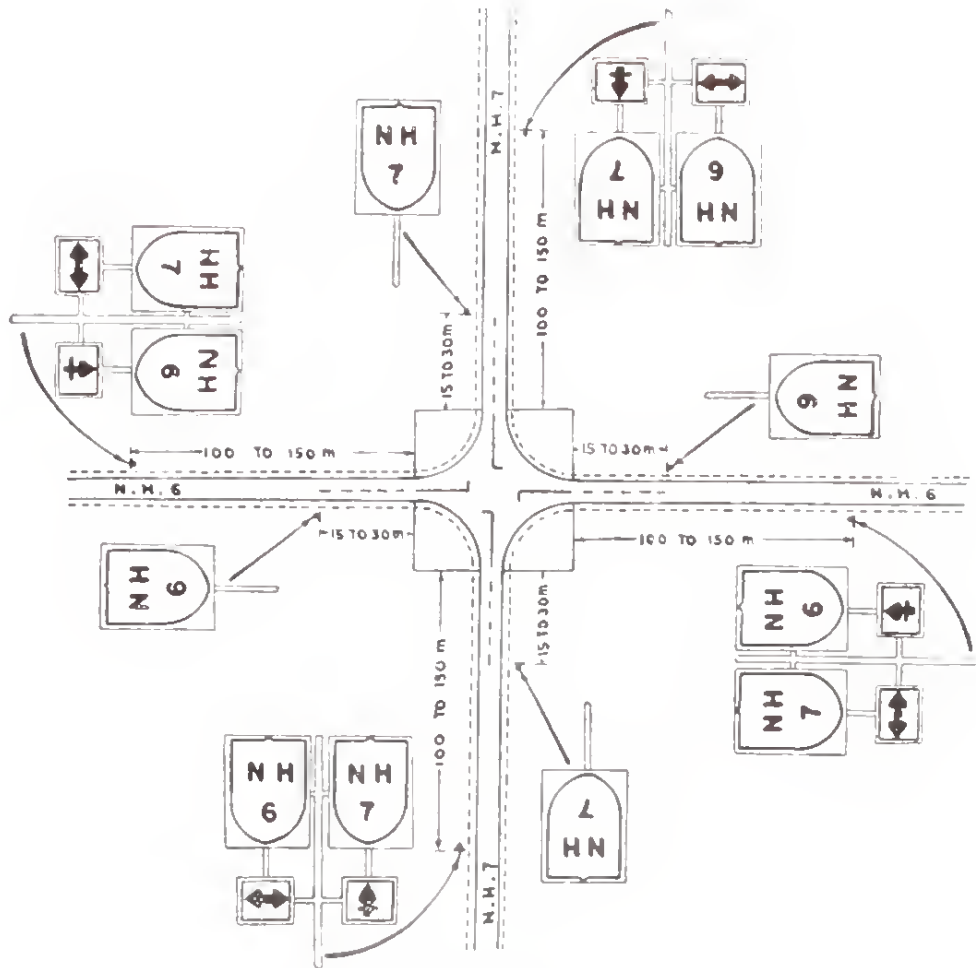

Example 1

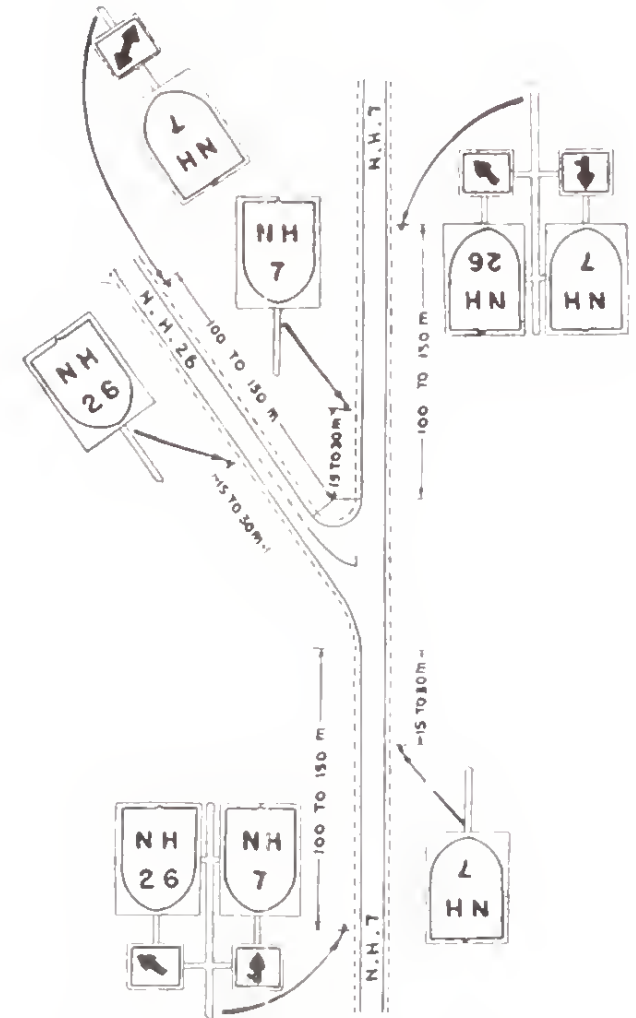

Example 2

NOTE : THE EXAMPLES GIVEN ABOVE ARE FOR THE CASE WHEN THE INTERSECTING ROUTE IS A NATIONAL HIGHWAY. THE ROUTE MARKER ASSEMBLY WILL BASICALLY BE THE SAME WHEN THE INTERSECTING ROUTE IS A STATE ROUTE OR OF SOME OTHER CLASSIFICATION, THE ONLY DIFFERENCE BEING IN THE SHIELD.

ROUTE MARKER ASSEMBLY AT JUNCTIONS OF NATIONAL HIGHWAYS WITH OTHER NUMBERED ROUTES

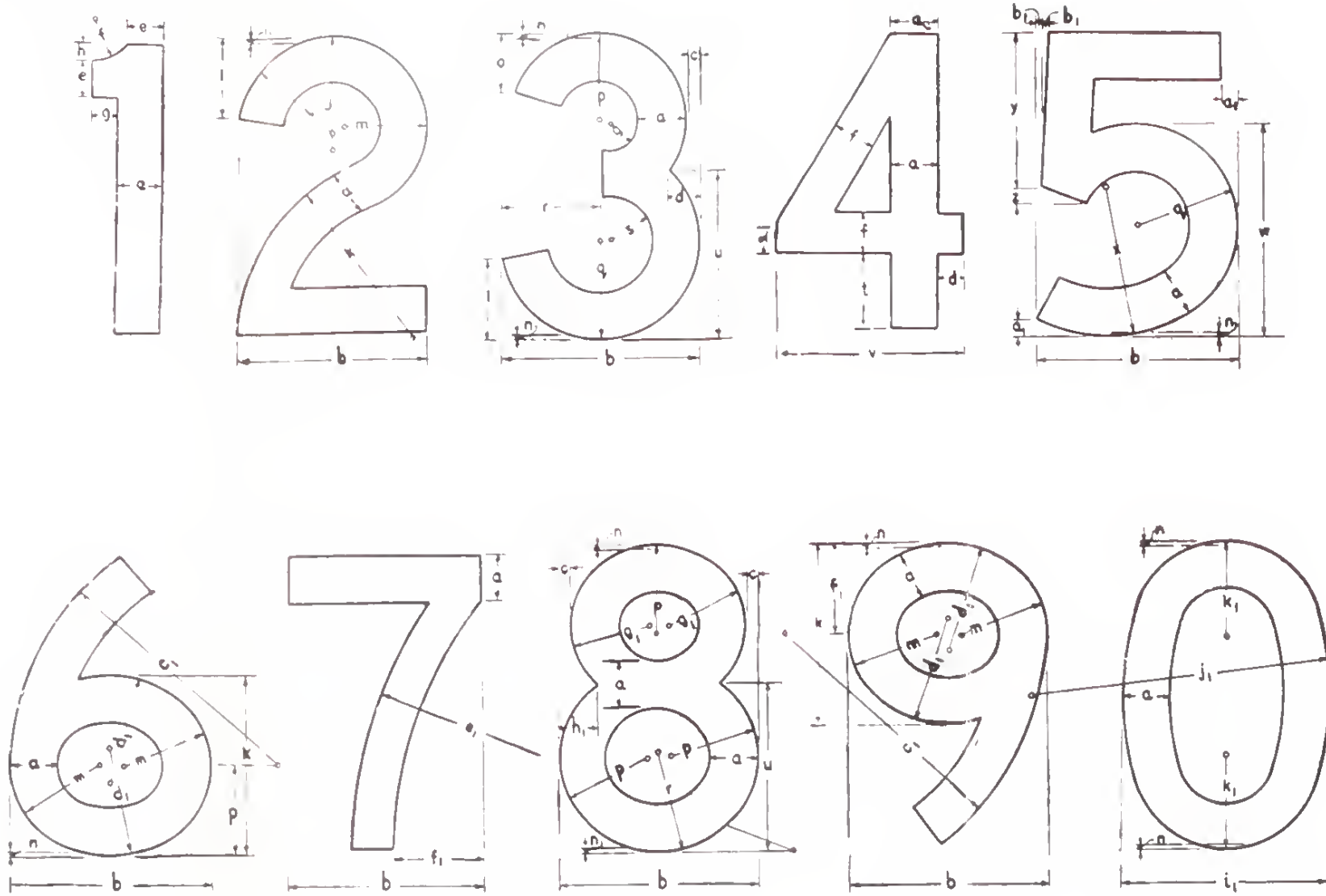

DIMENSIONS IN MILLIMETRES FOR 20 cm HIGH NUMERALS

a	a ₁	b	b ₁	c	c ₁	d	d ₁	e	e ₁	f	f ₁	g
31	11	134	5	8	178	19	72	25	300	28	59	17
g	h	h ₁	l	l ₁	j	j ₁	k	k ₁	l	m	n	o
52	13	23	66	141	78	200	122	64	53	58	3	41
p	q	r	s	t	u	v	w	x	y	z		
61	67	69	30	50	113	128	144	102	103	9		

SPACING BETWEEN STANDARD NUMERALS OF 20 cm HEIGHT

TABLE 1
NUMERAL TO NUMERAL CODE NUMBER

PRECEDING NUMERAL	FOLLOWING NUMERAL		
	1, 5	2, 3, 6 8, 9, 0	4, 7
1	1	1	2
2	1	2	2
3	1	2	2
4	2	2	4
5	1	2	2
6	1	2	2
7	2	2	4
8	1	2	2
9	1	2	2
0	1	2	2

TABLE 2
SPACING BETWEEN NUMERALS IN mm

CODE NUMBER	SPACING
1	47
2	38
4	13

NOTE:-
TO DETERMINE THE PROPER SPACING BETWEEN NUMERALS, OBTAIN THE CODE NUMBER FROM TABLE 1 AND ENTER TABLE 2 FOR THAT CODE NUMBER. SPACING IS MEASURED HORIZONTALLY FROM THE EXTREME RIGHT EDGE OF THE PRECEDING NUMERAL TO THE EXTREME LEFT EDGE OF THE FOLLOWING NUMERAL.

STANDARD NUMERALS OF 20 cm HEIGHT



